

Manufacturer's recommended retail prices for Vauxhall cars and accessories

Car and Accessory Price Guide

Effective from 1 May 2007 Edition 1



Contents

Customer information	2
Agila	4
Tigra	6
New Corsa	8
Meriva	12
Astra Sport Hatch	14
Astra hatchback	16
Astra estate	20
Astra TwinTop	22
Zafira	24
Vectra hatchback/saloon	26
Vectra estate	30
Signum	34
Antara	36
VXR	37
Pre-current model year vehicles	43
New Vivaro Combi	44
Movano Combi	45
Fuel consumption figures	46
Options explained	50
Accessories	54
Customer care	62

On-the-road prices

To eliminate uncertainty about hidden costs when buying a new car, Vauxhall publishes on-the-road recommended retail prices (RRP) and these are shown in the pricing tables within this price guide. These prices include the recommended cost of number plates and delivery to a Vauxhall retailer of £598.00 (including £89.06 VAT), 12 months' Government Vehicle Excise Duty (see page 3 for details) and the DVLA new vehicle first registration fee of £50.00*.

* = Correct at time of going to press.

Please note: The on-the-road recommended retail price (RRP) does not include fuel supplied by the retailer, motor insurance or any other goods or services supplied by agreement between the retailer and the customer.

Protecting the environment

Our products are increasingly winning environmental awards, both through the use of more recycled materials and by becoming cleaner and more efficient. For information on Vauxhall's efforts to achieve an environmentally sustainable future, including information on Design for Recycling, take-back of End-of-Life Vehicles (ELVs), and the recycling of ELVs, see www.vauxhall.co.uk/recycling. Looking to the future, we are also investing heavily in the biggest potential breakthrough of the next decade – the hydrogen fuel cell car.

Price protection

Order a new Vauxhall for build in the current model year (as confirmed by your retailer) for delivery no more than three months in advance and the price you are quoted is the price you pay. This is irrespective of any subsequent price rises between placing your order and delivery of your new car, but you must take delivery as soon as the car is available. Vauxhall Motors is not liable for price adjustments caused by Government changes in the rate of VAT (currently 17.5%), Vehicle Excise Duty, DVLA new vehicle first registration fee or by any other applicable legislation or regulations.

Vauxhall Internet Price (VIP)

All Vauxhall cars have a special Vauxhall internet price (VIP) as well as the on-the-road recommended retail price (RRP). See www.vauxhall.co.uk for details. It is Vauxhall's understanding that company car taxation will continue to be based on the on-the-road recommended retail price (RRP).

Vehicle Excise Duty

The amount of Vehicle Excise Duty (road fund licence) payable on new cars varies depending on the level of carbon dioxide (CO₂) emissions produced by the vehicle. CO₂ emissions are measured in grammes (g) per kilometre (km) travelled and divided into seven charging bands for each of the fuel types shown in the table on the right.

Vehicle Excise Duty*

	Band A	Band B	Band C	Band D	Band E	Band F	Band G
CO₂ emissions	up to 100g/km	101-120g/km	121-150g/km	151-165g/km	166-185g/km	186-225g/km	over 225g/km
Petrol/Diesel	£0.00	£35.00	£115.00	£140.00	£165.00	£205.00	£300.00

* = Correct at time of going to press.

Benefit in kind company car taxation**

The car benefit charge will be the car's list price (including VAT, options and accessories fitted, delivery to retailer and number plates, but excluding Vehicle Excise Duty and new vehicle first registration fee) multiplied by the percentage charge for the CO₂ emissions band in which the car falls (see table opposite). Multiply this figure by your personal income tax rate (22% for Basic Rate, 40% for Higher Rate, for 2007-08 tax year) to calculate your annual benefit in kind tax liability.

Example:

Astra Life 1.6i 16v manual 5-door hatchback (CO₂ emissions 156g/km)

On-the-road RRP	£13565.00
Deduct: Vehicle Excise Duty	(£140.00)
New vehicle first registration fee	(£50.00)
Effective list price	£13375.00
Add: Optional two-coat metallic paint	£350.00
List price for tax purposes (P11D value)	£13725.00
Car benefit charge	
2007-08 tax year (18%)	£2470.00
Benefit in kind tax liability (2007-08 tax year)	
Basic Rate (22%) tax payer	£543.00
Higher Rate (40%) tax payer	£988.00

** = Please note this Price Guide provides taxation information as a guide only. Vauxhall does not purport to provide taxation guidance. Drivers should always take professional advice on their own tax position.

CO ₂ emissions in grams per kilometre	Percentage of car's price to be taxed	
	Petrol	Diesel
2007-08 tax year		
up to 144	15	18
145-149	16	19
150-154	17	20
155-159	18	21
160-164	19	22
165-169	20	23
170-174	21	24
175-179	22	25
180-184	23	26
185-189	24	27
190-194	25	28
195-199	26	29
200-204	27	30
205-209	28	31
210-214	29	32
215-219	30	33
220-224	31	34
225-229	32	35
230-234	33	35
235-239	34	35
240 and above	35	35

To calculate your own personal liability a car tax calculator is available at www.vauxhall.co.uk/bik

5-door MPC



Model	Price (£)	VAT (£)	Total (£)	On-the-road RRP (£)	CO ₂ * (g/km)
Agila Expression					
1.0i 12v	4988.94	873.06	5862.00	6625.00	139
Agila Enjoy					
1.2i 16v	6793.19	1188.81	7982.00	8745.00	144
Agila Design					
1.2i 16v	7031.49	1230.51	8262.00	9025.00	144

Please note: On-the-road recommended retail prices (RRP) include number plates and delivery to retailer of £598.00 (inc. £89.06 VAT), 12 months' Vehicle Excise Duty (see page 3) and new vehicle first registration fee of £50.00. Excludes fuel and insurance.

* = CO₂ emission figures. Vehicle Excise Duty is based on CO₂ emissions (see page 3 for details). For benefit in kind taxation charges see page 3.

Option availability

	Expression	Enjoy	Design	Price (£) exc. VAT	Total (£) inc. VAT
Option packs					
Comfort Pack • Electrically operated front windows • Remote control central locking with security deadlocks	○	●	●	340.43	400.00
Exterior Styling Pack • 14-inch alloy wheels (steel spare) with locking wheel nuts • Front fog lights		○	○	382.98	450.00
Interior Pack¹ • ISOFIX child seat restraint system for outer rear seats (does not include child seat) • Centre rear seat head restraint • Map pockets on front seat backs • Luggage-restraining floor net • Net pockets in sides of luggage compartment • Driver's and front passenger's underseat storage trays		○	○	72.34	85.00
Safety options					
Front passenger's airbag ²	○	●	●	234.04	275.00
Front seat side-impact airbags ²	○ ³	○	○	170.21	200.00
Interior, seating and security options					
Air conditioning		○	●	425.53	500.00
Driver's seat height adjuster	○	●	●	51.06	60.00
Security alarm system (retailer-fit)**	○	○	○	265.00	311.37
Exterior and convenience options					
Slide/tilt glass sunroof with interior blind		○	○	340.43	400.00
Two-coat metallic or pearlescent paint		○	○	285.11	335.00
Audio option					
CC 20 stereo radio/cassette player	○	●	N/C	148.94	175.00

○ = Optional at extra cost. ● = Standard equipment. N/C = No-cost option. ** = Available at participating retailers only.

¹ = Deletes driver's seat height adjuster. ² = For details on the correct fitment of child seats when the vehicle is fitted with a front passenger's airbag or side-impact airbags please consult your Vauxhall retailer. ³ = Only available in conjunction with front passenger's airbag.

2-door coupé roadster

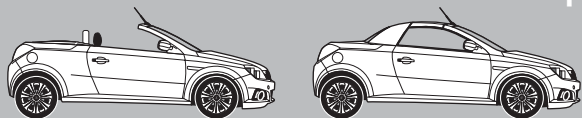

Model	Price (£)	VAT (£)	Total (£)	On-the-road RRP (£)	CO ₂ * (g/km)
Tigra					
1.4i 16v	11261.28	1970.72	13232.00	13995.00	146
1.4i 16v Easytronic	11840.00	2072.00	13912.00	14675.00	144
1.4i 16v (a/c)	11712.34	2049.66	13762.00	14525.00	146
1.4i 16v Easytronic (a/c)	12265.53	2146.47	14412.00	15175.00	144
Diesel					
1.3CDTi 16v	12146.38	2125.62	14272.00	15035.00	124
1.3CDTi 16v (a/c)	12571.91	2200.09	14772.00	15535.00	124
Tigra Sport					
1.4i 16v	12282.55	2149.45	14432.00	15195.00	146
1.8i 16v	12946.38	2265.62	15212.00	16025.00	185
1.4i 16v (a/c)	12708.09	2223.91	14932.00	15695.00	146
1.8i 16v (a/c)	13371.91	2340.09	15712.00	16525.00	185
Diesel					
1.3CDTi 16v	13125.11	2296.89	15422.00	16185.00	124
1.3CDTi 16v (a/c)	13550.64	2371.36	15922.00	16685.00	124
Tigra Exclusiv (Special Edition model)					
1.4i 16v (a/c)	12282.55	2149.45	14432.00	15195.00	146
1.4i 16v Easytronic (a/c)	12835.74	2246.26	15082.00	15845.00	144
1.8i 16v (a/c)	12946.38	2265.62	15212.00	16025.00	185
Tigra Exclusiv Red (Special Edition model)					
1.4i 16v (a/c)	12580.43	2201.57	14782.00	15545.00	146
1.8i 16v (a/c)	13244.26	2317.74	15562.00	16375.00	185

Please note: On-the-road recommended retail prices (RRP) include number plates and delivery to retailer of £598.00 (inc. £89.06 VAT), 12 months' Vehicle Excise Duty (see page 3) and new vehicle first registration fee of £50.00. Excludes fuel and insurance.

* = CO₂ emission figures. Vehicle Excise Duty is based on CO₂ emissions (see page 3 for details).

For benefit in kind taxation charges see page 3.

a/c = Air conditioning.

Option availability

	Tigra	Tigra Sport	Tigra Exclusiv	Tigra Exclusiv Red	Price (£) exc. VAT	Total (£) inc. VAT
Option packs						
VXR Styling Pack One • Body-colour front lower spoiler/rear lower skirt/boot lip spoiler and side sills	○	○	○	○	638.30	750.00
Leather Pack • Leather seat facings, head restraints and door trim insert panels • Electrically heated sports seats		○	●	●	510.64	600.00
Travel Pack • Windbreak • Retaining net for storage area behind seats	○	●	●	●	106.38	125.00
Plus Pack ¹ • Cruise control • Driver information centre including trip computer	○	○	○	○	255.32	300.00
Safety and security options						
Electronic Stability Programme (ESP) ⓘ see page 53	○	○	○	○	340.43	400.00
Automatic seat occupancy detection for passenger's airbags	○	○	○	○	106.38	125.00
Remote control ultrasonic security alarm system	○	●	●	●	191.49	225.00
Exterior options						
17-inch five-spoke alloy wheels with 205/45 R 17 tyres ²	○				382.98	450.00
17-inch five-spoke alloy wheels with 205/45 R 17 tyres ²		○	●	●	212.77	250.00
Rear parking distance sensor ⓘ see page 51	○	○	○	○	297.87	350.00
Targa roof bar in body colour	●	○ ³	○ ³	○ ³	85.11	100.00
Two-coat metallic or pearlescent paint	○	○	○	●	297.87	350.00
Audio and communication options						
CD 30 MP3 stereo radio/CD with MP3 capability	○	●	●	●	63.83	75.00
CD 70 stereo radio/CD with MP3 capability/satellite navigation with graphic display ⓘ see page 50	○	○	○	○	638.30	750.00

○ = Optional at extra cost ● = Standard equipment

¹ = Not available on 1.3CDTi 16v models. ² = The steel spare wheel is replaced by an emergency tyre inflation kit to effect a temporary 'get you home' repair. ³ = Standard on models with optional Star Silver two-coat metallic paint.



3-door hatchback

Model	Price (£)	VAT (£)	Total (£)	On-the-road RRP (£)	CO ₂ * (g/km)
New Corsa Expression					
1.0i 12v	5729.36	1002.64	6732.00	7495.00	134
New Corsa Life					
1.0i 12v	6669.79	1167.21	7837.00	8600.00	134
1.2i 16v	7010.21	1226.79	8237.00	9000.00	139
1.2i 16v Easytronic	7435.74	1301.26	8737.00	9500.00	137
1.0i 12v (a/c)	7095.32	1241.68	8337.00	9100.00	134
1.2i 16v (a/c)	7435.74	1301.26	8737.00	9500.00	139
1.2i 16v Easytronic (a/c)	7861.28	1375.72	9237.00	10000.00	137
Diesel					
1.3CDTi 16v (75PS)	7767.66	1359.34	9127.00	9810.00	119
1.3CDTi 16v (75PS) (a/c)	8193.19	1433.81	9627.00	10310.00	119
New Corsa Club					
1.2i 16v	7350.64	1286.36	8637.00	9400.00	139
1.2i 16v Easytronic	7776.17	1360.83	9137.00	9900.00	137
1.4i 16v	7776.17	1360.83	9137.00	9900.00	149
1.4i 16v auto	8605.96	1506.04	10112.00	10900.00	163
1.2i 16v (a/c)	7776.17	1360.83	9137.00	9900.00	139
1.2i 16v Easytronic (a/c)	8201.70	1435.30	9637.00	10400.00	137
1.4i 16v (a/c)	8201.70	1435.30	9637.00	10400.00	149
1.4i 16v auto (a/c)	9031.49	1580.51	10612.00	11400.00	163
Diesel					
1.3CDTi 16v (75PS)	8108.09	1418.91	9527.00	10210.00	119
1.3CDTi 16v (75PS) (a/c)	8533.62	1493.38	10027.00	10710.00	119
New Corsa Design					
1.2i 16v (a/c)	8754.89	1532.11	10287.00	11050.00	139
1.4i 16v (a/c)	9180.43	1606.57	10787.00	11550.00	149
1.4i 16v auto (a/c)	10010.21	1751.79	11762.00	12550.00	163
Diesel					
1.3CDTi 16v (90PS) (a/c)	9767.66	1709.34	11477.00	12240.00	124
1.7CDTi 16v (a/c)	10746.38	1880.62	12627.00	13390.00	130

Model	Price (£)	VAT (£)	Total (£)	On-the-road RRP (£)	CO ₂ * (g/km)
New Corsa SXi					
1.2i 16v	8116.60	1420.40	9537.00	10300.00	146
1.4i 16v	8542.13	1494.87	10037.00	10800.00	149
1.4i 16v auto	9371.91	1640.09	11012.00	11800.00	163
1.2i 16v (a/c)	8542.13	1494.87	10037.00	10800.00	146
1.4i 16v (a/c)	8967.66	1569.34	10537.00	11300.00	149
1.4i 16v auto (a/c)	9797.45	1714.55	11512.00	12300.00	163
Diesel					
1.3CDTi 16v (90PS)	9129.36	1597.64	10727.00	11490.00	124
1.7CDTi 16v	10108.09	1768.91	11877.00	12640.00	130
1.3CDTi 16v (90PS) (a/c)	9554.89	1672.11	11227.00	11990.00	124
1.7CDTi 16v (a/c)	10533.62	1843.38	12377.00	13140.00	130

Please note: On-the-road recommended retail prices (RRP) include number plates and delivery to retailer of £598.00 (inc. £89.06 VAT), 12 months' Vehicle Excise Duty (see page 3) and new vehicle first registration fee of £50.00. Excludes fuel and insurance.

* = CO₂ emission figures. Vehicle Excise Duty is based on CO₂ emissions (see page 3 for details).
For benefit in kind taxation charges see page 3.
a/c = Air conditioning.

For details of Corsa VXR please see page 37.



Option availability

	Expression	Life	Club	Design	SXi	Price (£) exc. VAT	Total (£) inc. VAT
Option packs							
VXR Styling Pack One ¹ • Body-colour front lower spoiler/side sills/rear lower skirt/rear roof spoiler • Chrome-effect exhaust tailpipe extension ²				○	○	680.85	800.00
Sight and Light Pack • Rain-sensitive windscreen wipers • Electro-chromatic anti-dazzle rear-view mirror • Automatic lighting control			○	●	○	127.66	150.00
Protection Pack • Front seat side-impact airbags • Full-size curtain airbags • Pyrotechnic front lap belt pretensioner system	○	○	●	●	●	340.43	400.00
Plus Pack • Driver's seat height adjuster • Steering column adjustable for reach and rake		○	●	●	●	85.11	100.00
Plus Pack • 15-inch alloy wheels (steel spare) • Front fog lights • Cruise control • Multi-function trip computer			○			382.98	450.00
Plus Pack • Electronic Climate Control (ECC) incorporating air conditioning i see page 52 • Cruise control • Multi-function trip computer • Graphic information display				○	○ ³	382.98	450.00
Hill Start Assist Pack ⁴ • Hill Start Assist (HSA) i see page 53 • Deflation Detection System (DDS) • Electronic Stability Programme-plus (ESP-plus) i see page 53		○	○			297.87	350.00
Safety options							
Electronic Stability Programme-plus (ESP-plus) with traction control i see page 53	○	○	○	○	○	340.43	400.00
ISOFIX child seat restraint system for front passenger's seat (does not include child seat)		○	○	○	○	85.11	100.00
Exterior and convenience options							
15-inch alloy wheels (steel spare) with 185/65 R 15 low profile tyres			○			340.43	400.00
17-inch alloy wheels with 215/45 R 17 ultra-low profile tyres				○ ⁵	○	255.32	300.00
Adaptive Forward Lighting (AFL) – halogen i see page 52			○	○	○	212.77	250.00
Electrically operated sliding glass sunroof with interior blind ⁶			○	○	○	468.09	550.00
Flex-Fix [®] integrated carrier system (includes two-bicycle carrier attachment) ⁷			○	○	○	319.15	375.00
Rear parking distance sensors ⁸ i see page 51			○	○	○	212.77	250.00
Two-coat metallic or pearlescent paint		○	○	○	○	297.87	350.00
Audio and communication options							
CD 60 stereo radio/CD with MP3 capability/auxiliary-in socket/satellite navigation with graphic display			○	○	○	829.79	975.00
Mobile phone system with Bluetooth [®] (does not include phone or cradle) and graphic display – see page 60 for details of mobile phone compatibility i see page 50			○	○	○	255.32	300.00

○ = Optional at extra cost. ● = Standard equipment.

¹ = Not available in conjunction with Flex-Fix[®] integrated carrier system. The spare wheel is replaced by an emergency tyre inflation kit. ² = Chrome-effect tailpipe extension is standard on SXi models. ³ = Only available on models fitted with air conditioning. ⁴ = Only available on Easytronic models. ⁵ = Also includes sports suspension with uprated and lowered springs. ⁶ = Also includes front passenger's seat height adjuster. Deletes front passenger's underseat storage tray.

⁷ = Not available in conjunction with VXR Styling Pack One or rear parking distance sensors. The spare wheel is replaced by an emergency tyre inflation kit. ⁸ = Not available in conjunction with Flex-Fix[®] integrated carrier system.

5-door hatchback

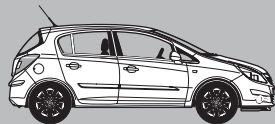

Model	Price (£)	VAT (£)	Total (£)	On-the-road RRP (£)	CO ₂ * (g/km)
New Corsa Life					
1.0i 12v	7222.98	1264.02	8487.00	9250.00	134
1.2i 16v	7563.40	1323.60	8887.00	9650.00	139
1.2i 16v Easytronic	7988.94	1398.06	9387.00	10150.00	137
1.0i 12v (a/c)	7648.51	1338.49	8987.00	9750.00	134
1.2i 16v (a/c)	7988.94	1398.06	9387.00	10150.00	139
1.2i 16v Easytronic (a/c)	8414.47	1472.53	9887.00	10650.00	137
Diesel					
1.3CDTi 16v (75PS)	8320.85	1456.15	9777.00	10460.00	119
1.3CDTi 16v (75PS) (a/c)	8746.38	1530.62	10277.00	10960.00	119
New Corsa Club					
1.2i 16v	7903.83	1383.17	9287.00	10050.00	139
1.2i 16v Easytronic	8329.36	1457.64	9787.00	10550.00	137
1.4i 16v	8329.36	1457.64	9787.00	10550.00	149
1.4i 16v auto	9137.87	1599.13	10737.00	11550.00	166
1.2i 16v (a/c)	8329.36	1457.64	9787.00	10550.00	139
1.2i 16v Easytronic (a/c)	8754.89	1532.11	10287.00	11050.00	137
1.4i 16v (a/c)	8754.89	1532.11	10287.00	11050.00	149
1.4i 16v auto (a/c)	9563.40	1673.60	11237.00	12050.00	166
Diesel					
1.3CDTi 16v (75PS)	8661.28	1515.72	10177.00	10860.00	119
1.3CDTi 16v (75PS) (a/c)	9086.81	1590.19	10677.00	11360.00	119
New Corsa Design					
1.2i 16v (a/c)	9308.09	1628.91	10937.00	11700.00	139
1.4i 16v (a/c)	9733.62	1703.38	11437.00	12200.00	149
1.4i 16v auto (a/c)	10542.13	1844.87	12387.00	13200.00	166
Diesel					
1.3CDTi 16v (90PS) (a/c)	10320.85	1806.15	12127.00	12890.00	124
1.7CDTi 16v (a/c)	11299.57	1977.43	13277.00	14040.00	132

Model	Price (£)	VAT (£)	Total (£)	On-the-road RRP (£)	CO ₂ * (g/km)
New Corsa SXi					
1.2i 16v	8669.79	1517.21	10187.00	10950.00	146
1.4i 16v	9095.32	1591.68	10687.00	11450.00	149
1.4i 16v auto	9903.83	1733.17	11637.00	12450.00	166
1.2i 16v (a/c)	9095.32	1591.68	10687.00	11450.00	146
1.4i 16v (a/c)	9520.85	1666.15	11187.00	11950.00	149
1.4i 16v auto (a/c)	10329.36	1807.64	12137.00	12950.00	166
Diesel					
1.3CDTi 16v (90PS)	9682.55	1694.45	11377.00	12140.00	124
1.7CDTi 16v	10661.28	1865.72	12527.00	13290.00	132
1.3CDTi 16v (90PS) (a/c)	10108.09	1768.91	11877.00	12640.00	124
1.7CDTi 16v (a/c)	11086.81	1940.19	13027.00	13790.00	132

Please note: On-the-road recommended retail prices (RRP) include number plates and delivery to retailer of £598.00 (inc. £89.06 VAT), 12 months' Vehicle Excise Duty (see page 3) and new vehicle first registration fee of £50.00. Excludes fuel and insurance.

* = CO₂ emission figures. Vehicle Excise Duty is based on CO₂ emissions (see page 3 for details).

For benefit in kind taxation charges see page 3.

a/c = Air conditioning.

Option availability

	Life	Club	Design	SXi	Price (£) exc. VAT	Total (£) inc. VAT
Option packs						
VXR Styling Pack One ¹ • Body-colour front lower spoiler/side sills/rear lower skirt/rear roof spoiler • Chrome-effect exhaust tailpipe extension ²			○	○	680.85	800.00
Sight and Light Pack • Rain-sensitive windscreen wipers • Electro-chromatic anti-dazzle rear-view mirror • Automatic lighting control		○	●	○	127.66	150.00
Protection Pack • Front seat side-impact airbags • Full-size curtain airbags • Pyrotechnic front lap belt pretensioner system	○	●	●	●	340.43	400.00
Plus Pack • Driver's seat height adjuster • Steering column adjustable for reach and rake	○	●	●	●	85.11	100.00
Plus Pack • 15-inch alloy wheels (steel spare) • Front fog lights • Cruise control • Multi-function trip computer		○			382.98	450.00
Plus Pack • Electronic Climate Control (ECC) incorporating air conditioning i see page 52 • Cruise control • Multi-function trip computer • Graphic information display			○	○ ³	382.98	450.00
Hill Start Assist Pack ⁴ • Hill Start Assist (HSA) i see page 53 • Deflation Detection System (DDS) • Electronic Stability Programme-plus (ESP-plus) i see page 53	○	○			297.87	350.00
Safety options						
Electronic Stability Programme-plus (ESP-plus) with traction control	○	○	○	○	340.43	400.00
ISOFIX child seat restraint system for front passenger's seat (does not include child seat)	○	○	○	○	85.11	100.00
Exterior and convenience options						
15-inch alloy wheels (steel spare) with 185/65 R 15 low profile tyres		○			340.43	400.00
17-inch alloy wheels with 215/45 R 17 ultra-low profile tyres			○ ⁵	○	255.32	300.00
Adaptive Forward Lighting (AFL) – halogen i see page 52		○	○	○	212.77	250.00
Electrically operated sliding glass sunroof with interior blind ⁶		○	○	○	468.09	550.00
Flex-Fix [®] integrated carrier system (includes two-bicycle carrier attachment) ⁷		○	○	○	319.15	375.00
Rear parking distance sensors ⁸ i see page 51		○	○	○	212.77	250.00
Two-coat metallic or pearlescent paint	○	○	○	○	297.87	350.00
Audio and communication options						
CD 60 stereo radio/CD with MP3 capability/auxiliary-in socket/satellite navigation with graphic display		○	○	○	829.79	975.00
Mobile phone system with Bluetooth [®] (does not include phone or cradle) and graphic display – see page 60 for details of mobile phone compatibility i see page 50		○	○	○	255.32	300.00

○ = Optional at extra cost. ● = Standard equipment.

¹ = Not available in conjunction with Flex-Fix[®] integrated carrier system. The spare wheel is replaced by an emergency tyre inflation kit. ² = Chrome-effect tailpipe extension is standard on SXi models. ³ = Only available on models fitted with air conditioning. ⁴ = Only available on Easytronic models. ⁵ = Also includes sports suspension with uprated and lowered springs. ⁶ = Also includes front passenger's seat height adjuster. Deletes front passenger's underseat storage tray.

⁷ = Not available in conjunction with VXR Styling Pack One or rear parking distance sensors. The spare wheel is replaced by an emergency tyre inflation kit. ⁸ = Not available in conjunction with Flex-Fix[®] integrated carrier system.

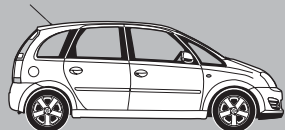

5-door MPV

Model	Price (£)	VAT (£)	Total (£)	On-the-road RRP (£)	CO ₂ * (g/km)
Meriva Expression					
1.4i 16v	8261.28	1445.72	9707.00	10495.00	154
<i>Diesel</i>					
1.3CDTi 16v	8946.38	1565.62	10512.00	11275.00	135
Meriva Life					
1.4i 16v	9282.55	1624.45	10907.00	11695.00	154
1.6i 16v	9878.30	1728.70	11607.00	12395.00	161
1.6i 16v Easytronic	10303.83	1803.17	12107.00	12895.00	161
1.4i 16v (a/c)	9708.09	1698.91	11407.00	12195.00	154
1.6i 16v (a/c)	10303.83	1803.17	12107.00	12895.00	161
1.6i 16v Easytronic (a/c)	10729.36	1877.64	12607.00	13395.00	161
<i>Diesel</i>					
1.3CDTi 16v	10397.45	1819.55	12217.00	12980.00	135
1.7CDTi 16v	11035.74	1931.26	12967.00	13730.00	140
1.3CDTi 16v (a/c)	10822.98	1894.02	12717.00	13480.00	135
1.7CDTi 16v (a/c)	11461.28	2005.72	13467.00	14230.00	140
Meriva Energy (Special Edition model)					
1.4i 16v (a/c)	10133.62	1773.38	11907.00	12695.00	154
1.6i 16v (a/c)	10729.36	1877.64	12607.00	13395.00	161
1.6i 16v Easytronic (a/c)	11154.89	1952.11	13107.00	13895.00	161
<i>Diesel</i>					
1.3CDTi 16v (a/c)	11248.51	1968.49	13217.00	13980.00	135
Meriva Club					
1.4i 16v (a/c)	10771.91	1885.09	12657.00	13445.00	154
1.6i 16v (a/c)	11367.66	1989.34	13357.00	14145.00	161
1.6i 16v Easytronic (a/c)	11793.19	2063.81	13857.00	14645.00	161
1.8i 16v (a/c)	11929.36	2087.64	14017.00	14870.00	190
1.8i 16v Easytronic (a/c)	12354.89	2162.11	14517.00	15370.00	187
<i>Diesel</i>					
1.3CDTi 16v (a/c)	11886.81	2080.19	13967.00	14730.00	135
1.7CDTi 16v (a/c)	12525.11	2191.89	14717.00	15480.00	140

Model	Price (£)	VAT (£)	Total (£)	On-the-road RRP (£)	CO ₂ * (g/km)
Meriva Design					
1.4i 16v (a/c)	10946.38	1915.62	12862.00	13650.00	154
1.6i 16v (a/c)	11542.13	2019.87	13562.00	14350.00	161
1.6i 16v Easytronic (a/c)	11967.66	2094.34	14062.00	14850.00	161
1.8i 16v (a/c)	12103.83	2118.17	14222.00	15075.00	190
1.8i 16v Easytronic (a/c)	12529.36	2192.64	14722.00	15575.00	187
<i>Diesel</i>					
1.7CDTi 16v (a/c)	12699.57	2222.43	14922.00	15685.00	140
Meriva Design with Exterior Pack**					
1.4i 16v (a/c)	11584.68	2027.32	13612.00	14400.00	154
1.6i 16v (a/c)	12180.43	2131.57	14312.00	15100.00	161
1.6i 16v Easytronic (a/c)	12605.96	2206.04	14812.00	15600.00	161
1.8i 16v (a/c)	12742.13	2229.87	14972.00	15825.00	190
1.8i 16v Easytronic (a/c)	13167.66	2304.34	15472.00	16325.00	187
<i>Diesel</i>					
1.7CDTi 16v (a/c)	13337.87	2334.13	15672.00	16435.00	140

Please note: On-the-road recommended retail prices (RRP) include number plates and delivery to retailer of £598.00 (inc. £89.06 VAT), 12 months' Vehicle Excise Duty (see page 3) and new vehicle first registration fee of £50.00. Excludes fuel and insurance.

* = CO₂ emission figures. Vehicle Excise Duty is based on CO₂ emissions (see page 3 for details).

For benefit in kind taxation charges see page 3.

** = Exterior Pack comprises 17-inch five-spoke alloy wheels and VXR Styling Pack One (see page 13 for details).

a/c = Air conditioning.

For details of Meriva VXR please see page 38.



Option availability

Option packs

	Expression	Life	Energy	Club	Design	Price (£) exc. VAT	Total (£) inc. VAT
VXR Styling Pack One¹ • Body-colour front lower spoiler/side sills/rear lower skirt/rear roof spoiler				○	○ ²	510.64	600.00
Protection Pack³ • Electronic Stability Programme (ESP) 1 see page 53 • Electronic traction control with two-way intervention • Front seat side-impact airbags • Full-size curtain airbags • Active-safety front seat head restraints • Automatic front seat occupancy detection • ISOFIX child seat restraint system for front passenger's seat (does not include child seat)	○	○	○	○	○	510.64	600.00
Plus Pack • 15-inch Structure wheels • Front fog lights • Leather-covered steering wheel • Dark-tinted Solar Protect® glass (excludes windscreen and front door windows) • Cruise control • Tilttable steering column				○		425.53	500.00
Plus Pack • Electronic Climate Control (ECC) 1 see page 52 • Solar Reflect® windscreen • Electro-chromatic anti-dazzle rear-view mirror • Indirect night lighting					○	340.43	400.00
Interior and seating options							
Front passenger's seat with fold-flat facility			○	○	○	85.11	100.00
Tilttable steering column		○	●	○	●	80.85	95.00
Exterior and convenience options							
16-inch alloy wheels (steel spare) with locking bolts and 205/50 R 16 ultra-low profile tyres					○	212.77	250.00
Adaptive Forward Lighting (AFL) – halogen 1 see page 52			○	○	○	212.77	250.00
Electrically operated slide/tilt glass front sunroof and tiltable glass rear sunroof			○ ⁴		●	510.64	600.00
Rear parking distance sensor – number plate mounted (retailer-fit) [†] 1 see page 51	○	○	○	○	○	144.67	169.99
Two-coat metallic or pearlescent paint		○	○	○	○	297.87	350.00
Audio and communication options							
CD 30 MP3 stereo radio/CD with MP3 capability		○	○	○	●	63.83	75.00
CD 70 stereo radio/CD with MP3 capability/satellite navigation with graphic display 1 see page 50			○	○	○	1021.28	1200.00
Roof-mounted removable DVD player (retailer-fit) [†] 1 see page 51	○	○	○ ⁴	○		632.23	742.87
Rear seat Twin Audio® system with single headset 1 see page 50			○ ⁵	○ ⁵	●	85.11	100.00
Mobile phone system with Bluetooth® (does not include phone or cradle) and graphic display ⁶ – see page 60 for details of mobile phone compatibility 1 see page 50			○	○		255.32	300.00

○ = Optional at extra cost. ● = Standard equipment. † = Available at participating retailers only.

1 = The spare wheel is replaced by an emergency tyre inflation kit. **2** = Standard on Design with Exterior Pack models. **3** = For details on the correct fitment of child seats when the vehicle is fitted with a front passenger's airbag or side-impact airbags please consult your Vauxhall retailer. **4** = DVD player not available with front and rear sunroofs. **5** = Only available in conjunction with optional audio units. Not available in conjunction with mobile phone system with Bluetooth®.

6 = Not available in conjunction with rear seat Twin Audio®.



Model	Price (£)	VAT (£)	Total (£)	On-the-road RRP (£)	CO ₂ * (g/km)
Astra Design					
1.6i 16v VVT	12448.51	2178.49	14627.00	15415.00	156
1.6i 16v VVT Easytronic	12831.49	2245.51	15077.00	15865.00	151
1.8i 16v VVT	12895.32	2256.68	15152.00	15965.00	175
1.8i 16v VVT auto	13742.13	2404.87	16147.00	16960.00	185
1.6i 16v Turbo	15095.32	2641.68	17737.00	18550.00	185
Diesel					
1.7CDTi 16v (100PS)	13563.40	2373.60	15937.00	16700.00	135
1.9CDTi (120PS)	14269.79	2497.21	16767.00	17555.00	157
1.9CDTi (120PS) auto	15376.17	2690.83	18067.00	18920.00	186
1.9CDTi 16v (150PS)	14993.19	2623.81	17617.00	18405.00	157
Astra SXi					
1.4i 16v	11618.72	2033.28	13652.00	14415.00	146
1.6i 16v VVT	12150.64	2126.36	14277.00	15065.00	156
1.6i 16v VVT Easytronic	12533.62	2193.38	14727.00	15515.00	151
Diesel					
1.7CDTi 16v (100PS)	13265.53	2321.47	15587.00	16350.00	135

Please note: On-the-road recommended retail prices (RRP) include number plates and delivery to retailer of £598.00 (inc. £89.06 VAT), 12 months' Vehicle Excise Duty (see page 3) and new vehicle first registration fee of £50.00. Excludes fuel and insurance.

* = CO₂ emission figures. Vehicle Excise Duty is based on CO₂ emissions (see page 3 for details).

For benefit in kind taxation charges see page 3.

** = Exterior Pack comprises 18-inch five-spoke alloy wheels and VXR Styling Pack One (see page 15 for details).

Sport Hatch

Model	Price (£)	VAT (£)	Total (£)	On-the-road RRP (£)	CO ₂ * (g/km)
Astra SRi					
1.8i 16v VVT	13180.43	2306.57	15487.00	16300.00	180
1.8i 16v VVT auto	14027.23	2454.77	16482.00	17335.00	190
1.6i 16v Turbo	14840.00	2597.00	17437.00	18250.00	185
Diesel					
1.7CDTi 16v (100PS)	13861.28	2425.72	16287.00	17050.00	138
1.9CDTi (120PS)	14312.34	2504.66	16817.00	17605.00	157
1.9CDTi (120PS) auto	15418.72	2698.28	18117.00	18970.00	186
1.9CDTi 16v (150PS)	14737.87	2579.13	17317.00	18105.00	157
Astra SRi with Exterior Pack**					
1.8i 16v VVT	13861.28	2425.72	16287.00	17100.00	180
1.8i 16v VVT auto	14708.09	2573.91	17282.00	18135.00	190
1.6i 16v Turbo	15520.85	2716.15	18237.00	19050.00	185
Diesel					
1.7CDTi 16v (100PS)	14542.13	2544.87	17087.00	17850.00	138
1.9CDTi (120PS)	14993.19	2623.81	17617.00	18405.00	157
1.9CDTi (120PS) auto	16099.57	2817.43	18917.00	19770.00	186
1.9CDTi 16v (150PS)	15418.72	2698.28	18117.00	18905.00	157

For details of Astra VXR please see page 39.



Option availability

	Design	SXi	SRI	Price (£) exc. VAT	Total (£) inc. VAT
Option packs					
Sight and Light Pack¹ • Rain-sensitive windscreen wipers • Electro-chromatic anti-dazzle rear-view mirror • Automatic lighting control	●	○	○	127.66	150.00
Leather Pack • Leather seat facings • Electrically heated sports front seats with tilt and lumbar adjustment • Indirect door night lighting • Centre rear seat head restraint • Front passenger's seat height adjuster		○	○	851.06	1000.00
Sports Pack • 17-inch 10-spoke alloy wheels with 225/45 R 17 tyres • Up-rated sports steering • Electronic Stability Programme-plus (ESP-plus) i see page 53 • Sport switch	○ ²			553.19	650.00
Premium Pack • 18-inch five-spoke alloy wheels with 225/40 R 18 ultra-low profile tyres • Leather seat facings in Saddle Brown • Electrically heated sports front seats • Zebrano-effect inserts on facia and doors	○ ³			1021.28	1200.00
VXR Styling Pack One • Body-colour front lower spoiler/rear lower skirt/rear roof spoiler (standard on SRI models) and side sills • Aerial adaptor	○	○	● ⁴	680.85	800.00
Safety option					
Electronic Stability Programme-plus (ESP-plus) i see page 53	○ ⁵	○	●	340.43	400.00
Security options					
Keyless entry and start i see page 51	○	○	○	255.32	300.00
Remote control ultrasonic security alarm ⁶	○	○	●	191.49	225.00
Interior options					
Electronic Climate Control (ECC) incorporating air conditioning i see page 52	○	○	○	234.04	275.00
Cruise control	○	○	○	170.21	200.00
Mechanical option					
Interactive Driving System-plus (IDS-plus) with Continuous Damping Control (CDC) i see page 53	○ ⁷		○	340.43	400.00
Exterior and convenience options					
Panoramic windscreen ⁸	○	○	○ ⁹	723.40	850.00
Electrically foldable door mirrors	○	○	○	106.38	125.00
Adaptive Forward Lighting (AFL) incorporating bi-xenon headlights with dynamic beam levelling and high-pressure washers i see page 52	○	○	○	638.30	750.00
18-inch five-spoke alloy wheels with 225/40 R 18 tyres			○ ⁴	255.32	300.00
Rear parking distance sensor i see page 51	○	○	○	297.87	350.00
Two-coat metallic or pearlescent paint	○	○	○	297.87	350.00
Audio and communication options					
CD 70 stereo radio/CD with MP3 capability/satellite navigation with colour monitor i see page 50	○	○	○	1063.83	1250.00
Mobile phone system with Bluetooth® (does not include phone or cradle) ¹ – see page 60 for details of mobile phone compatibility i see page 50	○	○	○	255.32	300.00

○ = Optional at extra cost. ● = Standard equipment.

¹ = Not available in conjunction with panoramic windscreen. ² = Standard on 1.6i 16v Turbo and 1.9CDTi 16v (150PS) models. Not available on models fitted with Easytronic transmission. 17-inch alloy wheels will affect the Vehicle Excise Duty payable on 1.8i 16v VVT automatic models – see page 3 for details. In addition, due to increased CO₂ emissions, on certain engines there will be a slight increase in benefit in kind charges for company car drivers. CO₂ emissions figures: 1.6i 16v VVT (manual) – 161g/km; 1.8i 16v VVT (manual) – 180g/km; 1.8i 16v VVT (automatic) – 190g/km. ³ = Only available on 1.6i 16v Turbo and 1.9CDTi 16v (150PS) models. Not available in conjunction with Power Red solid paint. ⁴ = Standard on SRI with Exterior Pack models. ⁵ = Standard on 1.6i 16v Turbo and 1.9CDTi diesel models. ⁶ = If fitted in conjunction with panoramic windscreen, ultrasonic sensors are deleted. ⁷ = Only available in conjunction with Sports Pack (Sports Pack is standard on 1.6i 16v Turbo and 1.9CDTi 16v (150PS) models). ⁸ = Not available in conjunction with Sight and Light Pack, VXR Styling Pack One or mobile phone system with Bluetooth®. Deletes illuminated driver's and front passenger's vanity mirrors, front map reading lights, body-colour roof mouldings and driver's sunglasses holder. Not available in conjunction with Glacier White solid paint. ⁹ = Not available on SRI with Exterior Pack models. Deletes ultrasonic sensors from remote control security alarm system.

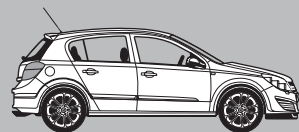

5-door hatchback

Model	Price (£)	VAT (£)	Total (£)	On-the-road RRP (£)	CO ₂ * (g/km)
Astra Expression					
1.4i 16v	9188.94	1608.06	10797.00	11560.00	146
Astra Life					
1.4i 16v	10342.13	1809.87	12152.00	12915.00	146
1.6i 16v VVT	10874.04	1902.96	12777.00	13565.00	156
1.6i 16v VVT Easytronic	11257.02	1969.98	13227.00	14015.00	151
1.8i 16v VVT	11320.85	1981.15	13302.00	14115.00	175
1.8i 16v VVT auto	12167.66	2129.34	14297.00	15150.00	187
1.4i 16v (a/c)	10767.66	1884.34	12652.00	13415.00	146
1.6i 16v VVT (a/c)	11299.57	1977.43	13277.00	14065.00	156
1.6i 16v VVT Easytronic (a/c)	11682.55	2044.45	13727.00	14515.00	151
1.8i 16v VVT (a/c)	11746.38	2055.62	13802.00	14615.00	175
1.8i 16v VVT auto (a/c)	12593.19	2203.81	14797.00	15650.00	187
Diesel					
1.3CDTi 16v (90PS)	11691.06	2045.94	13737.00	14500.00	130
1.3CDTi 16v (90PS) (a/c)	12116.60	2120.40	14237.00	15000.00	130
1.7CDTi 16v (100PS) (a/c)	12414.47	2172.53	14587.00	15350.00	135

Please note: On-the-road recommended retail prices (RRP) include number plates and delivery to retailer of £598.00 (inc. £89.06 VAT), 12 months' Vehicle Excise Duty (see page 3) and new vehicle first registration fee of £50.00. Excludes fuel and insurance.

* = CO₂ emission figures. Vehicle Excise Duty is based on CO₂ emissions (see page 3 for details).

For benefit in kind taxation charges see page 3.

a/c = Air conditioning.

Model	Price (£)	VAT (£)	Total (£)	On-the-road RRP (£)	CO ₂ * (g/km)
Astra Club					
1.4i 16v	11193.19	1958.81	13152.00	13915.00	146
1.6i 16v VVT	11725.11	2051.89	13777.00	14565.00	156
1.6i 16v VVT Easytronic	12108.09	2118.91	14227.00	15015.00	151
1.8i 16v VVT	12171.91	2130.09	14302.00	15115.00	175
1.8i 16v VVT auto	13018.72	2278.28	15297.00	16150.00	187
Diesel					
1.3CDTi 16v (90PS)	12542.13	2194.87	14737.00	15500.00	130
1.7CDTi 16v (100PS)	12840.00	2247.00	15087.00	15850.00	138
Astra Energy (Special Edition model)					
1.4i 16v	11193.19	1958.81	13152.00	13915.00	146
1.6i 16v VVT	11725.11	2051.89	13777.00	14565.00	156
1.8i 16v VVT auto	13018.72	2278.28	15297.00	16150.00	187
Diesel					
1.3CDTi 16v (90PS)	12542.13	2194.87	14737.00	15500.00	130
Astra Design					
1.6i 16v VVT	12448.51	2178.49	14627.00	15415.00	156
1.6i 16v VVT Easytronic	12831.49	2245.51	15077.00	15865.00	151
1.8i 16v VVT	12895.32	2256.68	15152.00	15965.00	175
1.8i 16v VVT auto	13742.13	2404.87	16147.00	17000.00	187
1.6i 16v Turbo	15095.32	2641.68	17737.00	18550.00	185
Diesel					
1.7CDTi 16v (100PS)	13563.40	2373.60	15937.00	16700.00	138
1.9CDTi (120PS)	14269.79	2497.21	16767.00	17555.00	157
1.9CDTi (120PS) auto	15376.17	2690.83	18067.00	18920.00	189
1.9CDTi 16v (150PS)	14993.19	2623.81	17617.00	18405.00	157

Option availability

	Expression	Life	Club	Energy	Design	Price (£) exc. VAT	Total (£) inc. VAT
Option packs							
Protection Pack 1 • Full-size curtain airbags • Active-safety front seat head restraints	○	○				170.21	200.00
Sports Pack • 17-inch 10-spoke alloy wheels with 225/45 R 17 tyres • Up-rated sports suspension • Up-rated sports steering • Electronic Stability Programme-plus (ESP-plus) i see page 53 • Sport switch					○ ²	553.19	650.00
VXR Styling Pack One • Body-colour front lower spoiler/rear lower skirt/rear roof spoiler and side sills • Aerial adaptor			○		○	680.85	800.00
Safety option							
Electronic Stability Programme-plus (ESP-plus) i see page 53	○	○	○	○	○ ³	340.43	400.00
Security options							
Keyless entry and start i see page 51			○	○	○	255.32	300.00
Remote control ultrasonic security alarm		○	○	○	○	191.49	225.00
Interior options							
Electronic Climate Control (ECC) incorporating air conditioning i see page 52			○	○	○	234.04	275.00
Cruise control			○	○	○	170.21	200.00
Mechanical option							
Interactive Driving System-plus (IDS-plus) with Continuous Damping Control (CDC) i see page 53					○ ⁴	340.43	400.00
Exterior and convenience options							
Electrically operated full-length slide/tilt sunroof			○		○	510.64	600.00
Electrically foldable door mirrors			○		○	106.38	125.00
Adaptive Forward Lighting (AFL) incorporating dark-style bi-xenon headlights with dynamic beam levelling and high-pressure washers i see page 52					○	638.30	750.00
17-inch five-spoke alloy wheels with 225/45 R 17 tyres			○ ⁵	○ ⁵		553.19	650.00
Rear parking distance sensor i see page 51			○		○	297.87	350.00
Two-coat metallic or pearlescent paint	○	○	○	○	○	297.87	350.00
Audio and communication options							
CD 30 MP3 stereo radio/CD with MP3 capability		○	○	●	●	63.83	75.00
CD 70 stereo radio/CD with MP3 capability/satellite navigation with colour monitor i see page 50		○	○		○	1063.83	1250.00
Mobile phone system with Bluetooth® (does not include phone or cradle) – see page 60 for details of mobile phone compatibility i see page 50		○ ⁶	○	○	○	255.32	300.00

○ = Optional at extra cost. ● = Standard equipment.

1 = For details on the correct fitment of child seats when the vehicle is fitted with a front passenger's airbag or side-impact airbags please consult your Vauxhall retailer. **2** = Standard on 1.6i 16v Turbo and 1.9CDTi 16v (150PS) models. Not available on models fitted with Easytronic transmission. Due to increased CO₂ emissions, on certain engines there will be a slight increase in benefit in kind charges for company car drivers. CO₂ emissions figures: 1.6i 16v VVT (manual) – 161g/km; 1.8i 16v VVT (manual) – 180g/km; 1.8i 16v VVT (automatic) – 192g/km. **3** = Standard on 1.6i 16v Turbo and 1.9CDTi diesel models. **4** = Only available in conjunction with Sports Pack (Sports Pack is standard on 1.6i 16v Turbo and 1.9CDTi 16v (150PS) models). **5** = Includes up-rated sports suspension, sports steering, ESP-plus and Sport switch. Not available on 1.4i 16v, 1.6i 16v Easytronic and 1.3CDTi 16v (90PS) models. Due to increased CO₂ emissions, on certain engines there will be a slight increase in benefit in kind charges for company car drivers. CO₂ emissions figures: 1.6i 16v VVT (manual) – 161g/km; 1.8i 16v VVT (manual) – 180g/km; 1.8i 16v VVT (automatic) – 192g/km. **6** = Includes steering wheel mounted audio controls.

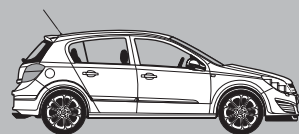

5-door hatchback

Model	Price (£)	VAT (£)	Total (£)	On-the-road RRP (£)	CO ₂ * (g/km)
Astra Elite					
1.6i 16v VVT	13342.13	2334.87	15677.00	16465.00	156
1.6i 16v VVT Easytronic	13725.11	2401.89	16127.00	16915.00	151
1.8i 16v VVT	13788.94	2413.06	16202.00	17015.00	175
1.8i 16v VVT auto	14635.74	2561.26	17197.00	18050.00	187
<i>Diesel</i>					
1.7CDTi 16v (100PS)	14457.02	2529.98	16987.00	17750.00	138
1.9CDTi (120PS)	15163.40	2653.60	17817.00	18605.00	157
1.9CDTi (120PS) auto	16269.79	2847.21	19117.00	19970.00	189
Astra SXi					
1.4i 16v	11618.72	2033.28	13652.00	14415.00	146
1.6i 16v VVT	12150.64	2126.36	14277.00	15065.00	156
1.6i 16v VVT Easytronic	12533.62	2193.38	14727.00	15515.00	151
<i>Diesel</i>					
1.7CDTi 16v (100PS)	13265.53	2321.47	15587.00	16350.00	138
Astra SRi					
1.8i 16v VVT	13180.43	2306.57	15487.00	16300.00	180
1.8i 16v VVT auto	14027.23	2454.77	16482.00	17335.00	192
1.6i 16v Turbo	14840.00	2597.00	17437.00	18250.00	185
<i>Diesel</i>					
1.7CDTi 16v (100PS)	13861.28	2425.72	16287.00	17050.00	138
1.9CDTi (120PS)	14312.34	2504.66	16817.00	17605.00	157
1.9CDTi (120PS) auto	15418.72	2698.28	18117.00	18970.00	189
1.9CDTi 16v (150PS)	14737.87	2579.13	17317.00	18105.00	157

Model	Price (£)	VAT (£)	Total (£)	On-the-road RRP (£)	CO ₂ * (g/km)
Astra SRi with Exterior Pack**					
1.8i 16v VVT	13861.28	2425.72	16287.00	17100.00	180
1.8i 16v VVT auto	14708.09	2573.91	17282.00	18135.00	192
1.6i 16v Turbo	15520.85	2716.15	18237.00	19050.00	185
<i>Diesel</i>					
1.7CDTi 16v (100PS)	14542.13	2544.87	17087.00	17850.00	138
1.9CDTi (120PS)	14993.19	2623.81	17617.00	18405.00	157
1.9CDTi (120PS) auto	16099.57	2817.43	18917.00	19770.00	189
1.9CDTi 16v (150PS)	15418.72	2698.28	18117.00	18905.00	157

Please note: On-the-road recommended retail prices (RRP) include number plates and delivery to retailer of £598.00 (inc. £89.06 VAT), 12 months' Vehicle Excise Duty (see page 3) and new vehicle first registration fee of £50.00. Excludes fuel and insurance.

* = CO₂ emission figures. Vehicle Excise Duty is based on CO₂ emissions (see page 3 for details). For benefit in kind taxation charges see page 3.

** = Exterior Pack comprises 18-inch five-spoke alloy wheels and VXR Styling Pack One (see page 19 for details).

a/c = Air conditioning.

Option availability

	Elite	SXi	SRi	Price (£) exc. VAT	Total (£) inc. VAT
Option packs					
Sight and Light Pack • Rain-sensitive windscreen wipers • Electro-chromatic anti-dazzle rear-view mirror • Automatic lighting control	●	○	○	127.66	150.00
Leather Pack • Leather seat facings • Electrically heated sports front seats with tilt and lumbar adjustment • Indirect door night lighting • Centre rear seat head restraint • Front passenger's seat height adjuster	●	○	○	851.06	1000.00
VXR Styling Pack One • Body-colour front lower spoiler/rear lower skirt/rear roof spoiler (standard on SRi models) and side sills • Aerial adaptor	○	○	● ¹	680.85	800.00
Safety option					
Electronic Stability Programme-plus (ESP-plus) ⓘ see page 53	○ ²	○	●	340.43	400.00
Security options					
Keyless entry and start ⓘ see page 51	○	○	○	255.32	300.00
Remote control ultrasonic security alarm	○	○	●	191.49	225.00
Interior options					
Electronic Climate Control (ECC) incorporating air conditioning ⓘ see page 52	●	○	○	234.04	275.00
Cruise control	●	○	○	170.21	200.00
Mechanical option					
Interactive Driving System-plus (IDS-plus) with Continuous Damping Control (CDC) ⓘ see page 53			○	340.43	400.00
Exterior and convenience options					
Electrically operated full-length slide/tilt sunroof	○	○	○	510.64	600.00
Electrically foldable door mirrors	●	○	○	106.38	125.00
Adaptive Forward Lighting (AFL) incorporating dark-style bi-xenon headlights with dynamic beam levelling and high-pressure washers ⓘ see page 52	○	○	○	638.30	750.00
18-inch five-spoke alloy wheels with 225/40 R 18 tyres			○ ¹	255.32	300.00
Rear parking distance sensor ⓘ see page 51	○	○	○	297.87	350.00
Two-coat metallic or pearlescent paint	○	○	○	297.87	350.00
Audio and communication options					
CD 70 stereo radio/CD with MP3 capability/satellite navigation with colour monitor ⓘ see page 50	○	○	○	1063.83	1250.00
Mobile phone system with Bluetooth® (does not include phone or cradle) – see page 60 for details of mobile phone compatibility ⓘ see page 50	○	○	○	255.32	300.00

○ = Optional at extra cost ● = Standard equipment.

¹ = Standard on SRi with Exterior Pack models. ² = Standard on 1.6i 16v Turbo and 1.9CDTi diesel models.



5-door estate

Model	Price (£)	VAT (£)	Total (£)	On-the-road RRP (£)	CO ₂ * (g/km)
Astra Life					
1.4i 16v	10980.43	1921.57	12902.00	13665.00	146
1.6i 16v VVT	11512.34	2014.66	13527.00	14315.00	158
1.6i 16v VVT Easytronic	11895.32	2081.68	13977.00	14765.00	154
1.8i 16v VVT	11946.38	2090.62	14037.00	14850.00	178
1.8i 16v VVT auto	12793.19	2238.81	15032.00	15885.00	187
1.4i 16v (a/c)	11405.96	1996.04	13402.00	14165.00	146
1.6i 16v VVT (a/c)	11937.87	2089.13	14027.00	14815.00	158
1.6i 16v VVT Easytronic (a/c)	12320.85	2156.15	14477.00	15265.00	154
1.8i 16v VVT (a/c)	12371.91	2165.09	14537.00	15350.00	178
1.8i 16v VVT auto (a/c)	13218.72	2313.28	15532.00	16385.00	187
<i>Diesel</i>					
1.3CDTi 16v (90PS)	12329.36	2157.64	14487.00	15250.00	130
1.3CDTi 16v (90PS) (a/c)	12754.89	2232.11	14987.00	15750.00	130
1.7CDTi 16v (100PS) (a/c)	13052.77	2284.23	15337.00	16100.00	135
Astra Club					
1.4i 16v	11831.49	2070.51	13902.00	14665.00	146
1.6i 16v VVT	12363.40	2163.60	14527.00	15315.00	158
1.6i 16v VVT Easytronic	12746.38	2230.62	14977.00	15765.00	154
1.8i 16v VVT	12797.45	2239.55	15037.00	15850.00	178
1.8i 16v VVT auto	13644.26	2387.74	16032.00	16885.00	187
<i>Diesel</i>					
1.3CDTi 16v (90PS)	13180.43	2306.57	15487.00	16250.00	130
1.7CDTi 16v (100PS)	13478.30	2358.70	15837.00	16600.00	138
Astra Energy (Special Edition model)					
1.4i 16v	11831.49	2070.51	13902.00	14665.00	146
1.6i 16v VVT	12363.40	2163.60	14527.00	15315.00	158
1.8i 16v VVT auto	13644.26	2387.74	16032.00	16885.00	187
<i>Diesel</i>					
1.3CDTi 16v (90PS)	13180.43	2306.57	15487.00	16250.00	130

Please note: On-the-road recommended retail prices (RRP) include number plates and delivery to retailer of £598.00 (inc. £89.06 VAT), 12 months' Vehicle Excise Duty (see page 3) and new vehicle first registration fee of £50.00. Excludes fuel and insurance.

* = CO₂ emission figures. Vehicle Excise Duty is based on CO₂ emissions (see page 3 for details). For benefit in kind taxation charges see page 3.

** = Exterior Pack comprises 18-inch five-spoke alloy wheels and VXR Styling Pack One (see page 21 for details).

a/c = Air conditioning.

Model	Price (£)	VAT (£)	Total (£)	On-the-road RRP (£)	CO ₂ * (g/km)
Astra Design					
1.6i 16v VVT	13086.81	2290.19	15377.00	16165.00	158
1.6i 16v VVT Easytronic	13469.79	2357.21	15827.00	16615.00	154
1.8i 16v VVT	13520.85	2366.15	15887.00	16700.00	178
1.8i 16v VVT auto	14367.66	2514.34	16882.00	17735.00	187
1.6i 16v Turbo	15733.62	2753.38	18487.00	19300.00	185
<i>Diesel</i>					
1.7CDTi 16v (100PS)	14201.70	2485.30	16687.00	17450.00	138
1.9CDTi (120PS)	14908.09	2608.91	17517.00	18305.00	159
1.9CDTi (120PS) auto	16014.47	2802.53	18817.00	19670.00	189
1.9CDTi 16v (150PS)	15631.49	2735.51	18367.00	19155.00	159
Astra SXi					
1.4i 16v	12257.02	2144.98	14402.00	15165.00	146
1.6i 16v VVT	12788.94	2238.06	15027.00	15815.00	158
1.6i 16v VVT Easytronic	13171.91	2305.09	15477.00	16265.00	154
<i>Diesel</i>					
1.7CDTi 16v (100PS)	13903.83	2433.17	16337.00	17100.00	138
Astra SRi					
1.8i 16v VVT	13818.72	2418.28	16237.00	17050.00	182
1.8i 16v VVT auto	14665.53	2566.47	17232.00	18085.00	192
1.6i 16v Turbo	15478.30	2708.70	18187.00	19000.00	185
<i>Diesel</i>					
1.7CDTi 16v (100PS)	14499.57	2537.43	17037.00	17800.00	138
1.9CDTi (120PS)	14950.64	2616.36	17567.00	18355.00	159
1.9CDTi (120PS) auto	16057.02	2809.98	18867.00	19720.00	189
1.9CDTi 16v (150PS)	15376.17	2690.83	18067.00	18855.00	159
Astra SRi with Exterior Pack**					
1.8i 16v VVT	14499.57	2537.43	17037.00	17850.00	182
1.8i 16v VVT auto	15346.38	2685.62	18032.00	18885.00	192
1.6i 16v Turbo	16159.15	2827.85	18987.00	19800.00	185
<i>Diesel</i>					
1.7CDTi 16v (100PS)	15180.43	2656.57	17837.00	18600.00	138
1.9CDTi (120PS)	15631.49	2735.51	18367.00	19155.00	159
1.9CDTi (120PS) auto	16737.87	2929.13	19667.00	20520.00	189
1.9CDTi 16v (150PS)	16057.02	2809.98	18867.00	19655.00	159

Option availability

	Life	Club	Energy	Design	SXi	SRi	Price (£) exc. VAT	Total (£) inc. VAT
Option packs								
Protection Pack 1 • Full-size curtain airbags • Active-safety front seat head restraints	○						170.21	200.00
Leather Pack • Leather seat facings • Electrically heated sports front seats with tilt and lumbar adjustment • Indirect door night lighting • Centre rear seat head restraint • Front passenger's seat height adjuster					○	○	851.06	1000.00
Sports Pack • 17-inch 10-spoke alloy wheels with 225/45 R 17 tyres • Uprated sports suspension • Uprated sports steering • Electronic Stability Programme-plus (ESP-plus) i see page 53 • Sport switch				○ ²			553.19	650.00
VXR Styling Pack One • Body-colour front lower spoiler/rear lower skirt/rear roof spoiler (standard on SRi models) and side sills • Aerial adaptor		○		○	○	● ³	680.85	800.00
Seat Comfort Pack • Driver's seat with tilt and lumbar adjustment		○					106.38	125.00
Convenience Pack • Vertical load-restraining net • 12-volt auxiliary power socket in luggage area		○		○	○	○	144.68	170.00
FlexOrganiser® option pack								
Organiser Pack • Four side rails • Divider net • Elasticated bag with four clips		○	○	○	○	○	42.55	50.00
Safety option								
Electronic Stability Programme-plus (ESP-plus) i see page 53	○	○	○	○ ⁴	○	●	340.43	400.00
Security options								
Keyless entry and start i see page 51		○	○	○	○	○	255.32	300.00
Remote control ultrasonic security alarm	○	○	○	○	○	●	191.49	225.00
Interior options								
Electronic Climate Control (ECC) incorporating air conditioning i see page 52		○	○	○	○	○	234.04	275.00
Cruise control		○	○	○	○	○	170.21	200.00
Mechanical option								
Interactive Driving System-plus (IDS-plus) with Continuous Damping Control (CDC) i see page 53				○ ⁵		○	340.43	400.00
Exterior and convenience options								
Electrically operated full-length slide/tilt sunroof		○		○	○	○	510.64	600.00
Electrically foldable door mirrors		○		○	○	○	106.38	125.00
Adaptive Forward Lighting (AFL) incorporating dark-style bi-xenon headlights with dynamic beam levelling and high-pressure washers i see page 52				○	○	○	638.30	750.00
17-inch five-spoke alloy wheels with 225/45 R 17 tyres		○ ⁶	○ ⁶			●	553.19	650.00
18-inch five-spoke alloy wheels with 225/40 R 18 tyres						○ ³	255.32	300.00
Rear parking distance sensor i see page 51		○		○	○	○	297.87	350.00
Two-coat metallic or pearlescent paint	○	○	○	○	○	○	297.87	350.00
Audio and communication options								
CD 30 MP3 stereo radio/CD with MP3 capability	○	○	●	●	●	●	63.83	75.00
CD 70 stereo radio/CD with MP3 capability/satellite navigation with colour monitor i see page 50	○	○		○	○	○	1063.83	1250.00
Mobile phone system with Bluetooth® (does not include phone or cradle) – see page 60 for details of mobile phone compatibility i see page 50	○ ⁷	○	○	○	○	○	255.32	300.00

○ = Optional at extra cost ● = Standard equipment

1 = For details on the correct fitment of child seats when the vehicle is fitted with a front passenger's airbag or side-impact airbags please consult your Vauxhall retailer. 2 = Standard on 1.6i 16v Turbo and 1.9CDTi 16v (150PS) models. Not available on models fitted with Easytronic transmission. Due to increased CO₂ emissions, on certain engines there will be a slight increase in benefit in kind charges for company car drivers. CO₂ emissions figures: 1.6i 16v VVT (manual) – 163g/km; 1.8i 16v VVT (manual) – 182g/km; 1.8i 16v VVT (automatic) – 192g/km. 3 = Standard on SRi with Exterior Pack models. 4 = Standard on 1.6i 16v Turbo and 1.9CDTi diesel models. 5 = Only available in conjunction with Sports Pack (Sports Pack is standard on 1.6i 16v Turbo and 1.9CDTi 16v (150PS) models). 6 = Includes uprated sports suspension, sports steering, ESP-plus and Sport switch. Not available on 1.4i 16v, 1.6i 16v Easytronic and 1.3CDTi 16v (90PS) models. Due to increased CO₂ emissions, on certain engines there will be a slight increase in benefit in kind charges for company car drivers. CO₂ emissions figures: 1.6i 16v VVT (manual) – 163g/km; 1.8i 16v VVT (manual) – 182g/km; 1.8i 16v VVT (automatic) – 192g/km. 7 = Includes steering wheel mounted audio controls.

2-door coupé convertible

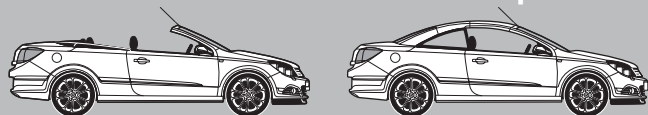

Model	Price (£)	VAT (£)	Total (£)	On-the-road RRP (£)	CO ₂ * (g/km)
Astra TwinTop					
1.6i 16v VVT	13942.13	2439.87	16382.00	17195.00	166
1.8i 16v VVT	14367.66	2514.34	16882.00	17695.00	185
1.8i 16v VVT auto	15214.47	2662.53	17877.00	18730.00	194
<i>Diesel</i>					
1.9CDTi 16v (150PS)	16065.53	2811.47	18877.00	19665.00	160
Astra TwinTop Sport					
1.6i 16v VVT	14622.98	2559.02	17182.00	17995.00	166
1.8i 16v VVT	15048.51	2633.49	17682.00	18495.00	185
1.8i 16v VVT auto	15895.32	2781.68	18677.00	19530.00	194
<i>Diesel</i>					
1.9CDTi 16v (150PS)	16746.38	2930.62	19677.00	20465.00	160
Astra TwinTop Design					
1.8i 16v VVT	15644.26	2737.74	18382.00	19195.00	185
1.8i 16v VVT auto	16491.06	2885.94	19377.00	20230.00	194
2.0i 16v Turbo (200PS)	17342.13	3034.87	20377.00	21325.00	228
<i>Diesel</i>					
1.9CDTi 16v (150PS)	17342.13	3034.87	20377.00	21165.00	160
Astra TwinTop Exclusiv Black (Special Edition model)					
1.8i 16v VVT	15244.26	2667.74	17912.00	18725.00	185
1.8i 16v VVT auto	16091.06	2815.94	18907.00	19760.00	194
2.0i 16v Turbo (200PS)	16942.13	2964.87	19907.00	20855.00	228
<i>Diesel</i>					
1.9CDTi 16v (150PS)	16942.13	2964.87	19907.00	20695.00	160

Please note: On-the-road recommended retail prices (RRP) include number plates and delivery to retailer of £598.00 (inc. £89.06 VAT), 12 months' Vehicle Excise Duty (see page 3) and new vehicle first registration fee of £50.00. Excludes fuel and insurance.

* = CO₂ emission figures. Vehicle Excise Duty is based on CO₂ emissions (see page 3 for details). For benefit in kind taxation charges see page 3.

Option availability

	TwinTop	Sport	Design	Exclusiv Black	Price (£) exc. VAT	Total (£) inc. VAT
Option packs						
Leather Pack • Leather seat facings • Electrically heated sports front seats with driver's tilt and lumbar adjustment • Indirect door night lighting			○	●	638.30	750.00
Plus Pack • 17-inch five-spoke alloy wheels with 225/45 R 17 ultra-low profile tyres • Cruise control		○			297.87	350.00
Plus Pack • 18-inch 11-spoke alloy wheels with 225/40 R 18 ultra-low profile tyres • Cruise control			○		382.98	450.00
Premium Pack • 18-inch 11-spoke alloy wheels with 225/40 R 18 ultra-low profile tyres • Cruise control • CD 70 stereo radio/CD with MP3 capability/satellite navigation with colour monitor 1 see page 50			○		1191.49	1400.00
Safety option						
Electronic Stability Programme-plus (ESP-plus) with traction control 1 see page 53	○ ¹	○ ¹	●	●	340.43	400.00
Interior option						
Cruise control	○	○	○	●	170.21	200.00
Exterior and convenience options						
Adaptive Forward Lighting (AFL) incorporating dark-style bi-xenon headlights with dynamic beam levelling and high-pressure washers 1 see page 52			○	○	638.30	750.00
Steel space-saver spare wheel/tyre (in lieu of emergency tyre inflation kit)	○	○	○		85.11	100.00
Rear parking distance sensor 1 see page 51	○	○	○	○	297.87	350.00
Windbreak	○	○	●	●	127.66	150.00
Two-coat metallic or pearlescent paint	○	○	○	○	297.87	350.00
Audio and communication options						
CD 70 stereo radio/CD with MP3 capability/satellite navigation with colour monitor 1 see page 50		○	○	○	1063.83	1250.00
Mobile phone system with Bluetooth® (does not include phone or cradle) ² – see page 60 for details of mobile phone compatibility 1 see page 50	○	○	○		255.32	300.00

○ = Optional at extra cost ● = Standard equipment.

1 = Standard on 1.9CDTi 16v models only **2** = Includes graphic information display.



5-door MPV

Model	Price (£)	VAT (£)	Total (£)	On-the-road RRP (£)	CO ₂ * (g/km)
Zafira Expression					
1.6i 16v	10835.74	1896.26	12732.00	13545.00	175
Zafira Life					
1.6i 16v	11903.83	2083.17	13987.00	14800.00	175
1.6i 16v (a/c)	12329.36	2157.64	14487.00	15300.00	175
1.8i 16v VVT	12912.34	2259.66	15172.00	16025.00	187
1.8i 16v VVT Easytronic	13350.64	2336.36	15687.00	16500.00	182
2.2i 16v Direct	13891.06	2430.94	16322.00	17175.00	197
2.2i 16v Direct auto	14742.13	2579.87	17322.00	18175.00	204
<i>Diesel</i>					
1.9CDTi (120PS)	14044.26	2457.74	16502.00	17290.00	162
1.9CDTi (120PS) auto	15150.64	2651.36	17802.00	18655.00	194
Zafira Club					
1.6i 16v	12520.85	2191.15	14712.00	15525.00	175
1.6i 16v (a/c)	12946.38	2265.62	15212.00	16025.00	175
1.8i 16v VVT	13529.36	2367.64	15897.00	16750.00	187
1.8i 16v VVT Easytronic	13967.66	2444.34	16412.00	17225.00	182
2.2i 16v Direct	14508.09	2538.91	17047.00	17900.00	197
2.2i 16v Direct auto	15359.15	2687.85	18047.00	18900.00	204
<i>Diesel</i>					
1.9CDTi (120PS)	14661.28	2565.72	17227.00	18015.00	162
1.9CDTi (120PS) auto	15767.66	2759.34	18527.00	19380.00	194
Zafira Energy (Special Edition model)					
1.6i 16v	12946.38	2265.62	15212.00	16025.00	175
1.8i 16v VVT	13529.36	2367.64	15897.00	16750.00	187
2.2i 16v Direct auto	15359.15	2687.85	18047.00	18900.00	204
<i>Diesel</i>					
1.9CDTi (120PS)	14661.28	2565.72	17227.00	18015.00	162
1.9CDTi (120PS) auto	15767.66	2759.34	18527.00	19380.00	194

Please note: On-the-road recommended retail prices (RRP) include number plates and delivery to retailer of £598.00 (inc. £89.06 VAT), 12 months' Vehicle Excise Duty (see page 3) and new vehicle first registration fee of £50.00. Excludes fuel and insurance.

* = CO₂ emission figures. Vehicle Excise Duty is based on CO₂ emissions (see page 3 for details).

For benefit in kind taxation charges see page 3.

a/c = Air conditioning.

Model	Price (£)	VAT (£)	Total (£)	On-the-road RRP (£)	CO ₂ * (g/km)
Zafira Design					
1.8i 16v VVT	14550.64	2546.36	17097.00	17950.00	187
1.8i 16v VVT Easytronic	14988.94	2623.06	17612.00	18425.00	182
2.2i 16v Direct	15742.13	2754.87	18497.00	19350.00	197
2.2i 16v Direct auto	16593.19	2903.81	19497.00	20350.00	204
2.0i 16v Turbo (200PS)	16976.17	2970.83	19947.00	20895.00	228
<i>Diesel</i>					
1.9CDTi (120PS)	15682.55	2744.45	18427.00	19215.00	162
1.9CDTi (120PS) auto	16788.94	2938.06	19727.00	20580.00	194
1.9CDTi 16v (150PS)	16640.00	2912.00	19552.00	20340.00	165
1.9CDTi 16v (150PS) auto	17746.38	3105.62	20852.00	21705.00	194
Zafira SRi					
1.8i 16v VVT	14720.85	2576.15	17297.00	18150.00	187
2.2i 16v Direct	15359.15	2687.85	18047.00	18900.00	197
2.2i 16v Direct auto	16210.21	2836.79	19047.00	19900.00	204
2.0i 16v Turbo (200PS)	16593.19	2903.81	19497.00	20445.00	228
<i>Diesel</i>					
1.9CDTi (120PS)	15852.77	2774.23	18627.00	19415.00	162
1.9CDTi (120PS) auto	16959.15	2967.85	19927.00	20780.00	194
1.9CDTi 16v (150PS)	16257.02	2844.98	19102.00	19890.00	165
1.9CDTi 16v (150PS) auto	17363.40	3038.60	20402.00	21255.00	194
Zafira SRi with Exterior Pack**					
1.8i 16v VVT	15401.70	2695.30	18097.00	18950.00	187
2.2i 16v Direct	16040.00	2807.00	18847.00	19700.00	197
2.2i 16v Direct auto	16891.06	2955.94	19847.00	20700.00	204
2.0i 16v Turbo (200PS)	17274.04	3022.96	20297.00	21245.00	228
<i>Diesel</i>					
1.9CDTi (120PS)	16533.62	2893.38	19427.00	20215.00	162
1.9CDTi (120PS) auto	17640.00	3087.00	20727.00	21580.00	194
1.9CDTi 16v (150PS)	16937.87	2964.13	19902.00	20690.00	165
1.9CDTi 16v (150PS) auto	18044.26	3157.74	21202.00	22055.00	194

** = Exterior Pack comprises 18-inch five-spoke alloy wheels and VXR Styling Pack One (see page 25 for details).

For details of Zafira VXR please see page 40.



Option availability

	Expression	Life	Club	Energy	Design	SRI	Price (£) exc. VAT	Total (£) inc. VAT
Option packs								
VXR Styling Pack One • Body-colour lower front spoiler/rear lower skirt/rear roof spoiler and side sills			○		○	○ ¹	680.85	800.00
Leather Pack ² • Leather seat facings • Electrically heated sports front seats with tilt and lumbar adjustment • Driver's armrest • Front passenger's seat height adjuster					○	○	851.06	1000.00
Seat Comfort Pack 1 • Driver's seat with tilt and lumbar adjustment			○		●	●	85.11	100.00
Seat Comfort Pack 2 ² • Front passenger's seat with height, tilt and lumbar adjustment			○ ³		○	○	85.11	100.00
Panoramic Roof Pack ⁴ • Four glass roof panels • Roof-mounted storage console for front and rear passengers • Alloy-effect roof rails • Heat-reflective windscreen			○ ⁵		○ ⁵	○	723.40	850.00
Towing Pack ⁵ • Trailer stability programme • Hill Start Assist (HSA) ⁶ ⓘ see page 53 • Deflation Detection System (DDS) ⁶ • Cruise control • Detachable tow bar			○ ⁷		○ ⁷		297.87	350.00
FlexOrganiser® option pack								
Organiser Pack • 3D storage net • Side net pocket • Four side rail hooks • Four side rails			○	○	○	○	42.55	50.00
Safety options								
Electronic Stability Programme-plus (ESP-plus) (1.6i 16v/1.8i 16v/1.9CDTi (120PS) only) ⓘ see page 53	○	○ ⁸	○ ⁸	○ ⁸	○ ⁹	●	340.43	400.00
Full-size curtain airbags (front and second-row seating)	○	○	●	●	●	●	170.21	200.00
Security options								
Keyless entry and start ⓘ see page 51			○	○	○	○	255.32	300.00
Remote control ultrasonic security alarm system		○	○	○	○	●	191.49	225.00
Interior options								
Electronic Climate Control (ECC) ⓘ see page 52			○ ¹⁰	○	○	○	234.04	275.00
Cruise control			○	○	○	○	170.21	200.00
Mechanical option								
Interactive Driving System-plus (IDS-plus) with Continuous Damping Control (CDC) ⓘ see page 53						○	340.43	400.00
Exterior and convenience options								
Adaptive Forward Lighting (AFL) incorporating bi-xenon headlights with dynamic beam levelling and high-pressure washers ⓘ see page 52			○ ¹¹		○	○	638.30	750.00
17-inch 10-spoke alloy wheels with 225/45 R 17 ultra-low profile tyres			○ ¹²	○ ¹²	● ⁹		340.43	400.00
18-inch five-spoke alloy wheels with 225/40 R 18 ultra-low profile tyres						○ ^{1,13}	255.32	300.00
Full-size steel spare wheel (in lieu of emergency tyre inflation kit)	○	○	○	○	○ ¹⁴	○ ¹⁴	85.11	100.00
Front and rear parking distance sensors ⓘ see page 51			○	○	○	○	297.87	350.00
Two-coat metallic or pearlescent paint	○	○	○	○	○	○	297.87	350.00
Audio and communication options								
CD 30 MP3 stereo radio/CD with MP3 capability		○	○		○	○	63.83	75.00
CD 70 stereo radio/CD with MP3 capability/satellite navigation with colour monitor ⓘ see page 50		○	○		○	○	1063.83	1250.00
Roof-mounted removable DVD player (retailer-fit) ¹⁵ ⓘ see page 51		○	○	○	○	○	632.23	742.87
Rear seat Twin Audio® system with single headset ¹⁶ ⓘ see page 50			○		○	○	85.11	100.00
Mobile phone system with Bluetooth® (does not include phone or cradle) – see page 60 for details of mobile phone compatibility ⓘ see page 50		○	○	○	○	○	255.32	300.00

○ = Optional at extra cost. ● = Standard equipment.

1 = Standard on SRI with Exterior Pack models. 2 = Deletes front passenger's underseat storage tray. 3 = Only available in conjunction with Seat Comfort Pack 1. 4 = Not available in conjunction with Glacier White solid paint or on 1.9CDTi 16v (150PS) automatic SRI with Exterior Pack models. 5 = Only available in conjunction with Electronic Stability Programme-plus. 6 = Not available on models fitted with automatic transmission. 7 = Requires 13-pin adaptor (available as a Vauxhall accessory). 8 = Standard on 2.2i 16v Direct model. 9 = Standard on 2.2i 16v Direct, 2.0i 16v Turbo and 1.9CDTi 16v (150PS) models. 10 = Only available on models fitted with air conditioning. 11 = Includes front fog lights. 12 = Includes Electronic Stability Programme-plus. 13 = Not available on 1.9CDTi 16v (150PS) automatic model with Panoramic Roof Pack. 14 = Not available on 2.0i 16v Turbo models, SRI with Exterior Pack models and 18-inch alloy wheels. 15 = Not available in conjunction with Panoramic Roof Pack. Available at participating retailers only. 16 = Only available in conjunction with optional audio units.

5-door hatchback

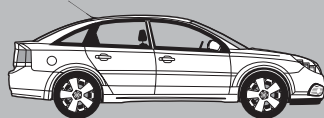

Model	Price (£)	VAT (£)	Total (£)	On-the-road RRP (£)	CO ₂ * (g/km)
Vectra Life					
1.8i 16v VVT	13180.43	2306.57	15487.00	16300.00	173
<i>Diesel</i>					
1.9CDTi (120PS)	14457.02	2529.98	16987.00	17775.00	154
1.9CDTi 16v (150PS)	14882.55	2604.45	17487.00	18275.00	154
1.9CDTi 16v (150PS) auto	16286.81	2850.19	19137.00	19990.00	186
Vectra Exclusiv					
1.8i 16v VVT	11988.94	2098.06	14087.00	14900.00	173
<i>Diesel</i>					
1.9CDTi (120PS)	12840.00	2247.00	15087.00	15875.00	154
1.9CDTi 16v (150PS)	13265.53	2321.47	15587.00	16375.00	154
1.9CDTi 16v (150PS) auto	14669.79	2567.21	17237.00	18090.00	186
Vectra Design					
1.8i 16v VVT	14584.68	2552.32	17137.00	17950.00	173
2.2i 16v Direct	15095.32	2641.68	17737.00	18550.00	180
2.2i 16v Direct auto	16201.70	2835.30	19037.00	19890.00	192
<i>Diesel</i>					
1.9CDTi (120PS)	15861.28	2775.72	18637.00	19425.00	154
1.9CDTi 16v (150PS)	16286.81	2850.19	19137.00	19925.00	154
1.9CDTi 16v (150PS) auto	17691.06	3095.94	20787.00	21640.00	186
Vectra Elite Nav**					
2.2i 16v Direct	17095.32	2991.68	20087.00	20900.00	180
2.2i 16v Direct auto	18201.70	3185.30	21387.00	22240.00	192
2.8i V6 24v Turbo auto	19946.38	3490.62	23437.00	24385.00	262
<i>Diesel</i>					
1.9CDTi 16v (150PS)	18286.81	3200.19	21487.00	22275.00	154
1.9CDTi 16v (150PS) auto	19691.06	3445.94	23137.00	23990.00	186
3.0CDTi V6 24v	20840.00	3647.00	24487.00	25340.00	186
3.0CDTi V6 24v auto	21946.38	3840.62	25787.00	26640.00	192

4-door saloon



Model	Price (£)	VAT (£)	Total (£)	On-the-road RRP (£)	CO ₂ * (g/km)
Vectra Life					
1.8i 16v VVT	13180.43	2306.57	15487.00	16300.00	173
<i>Diesel</i>					
1.9CDTi (120PS)	14457.02	2529.98	16987.00	17775.00	154
1.9CDTi 16v (150PS)	14882.55	2604.45	17487.00	18275.00	154
1.9CDTi 16v (150PS) auto	16286.81	2850.19	19137.00	19950.00	184
Vectra Design					
1.8i 16v VVT	14584.68	2552.32	17137.00	17950.00	173
2.2i 16v Direct	15095.32	2641.68	17737.00	18550.00	180
2.2i 16v Direct auto	16201.70	2835.30	19037.00	19890.00	192
<i>Diesel</i>					
1.9CDTi (120PS)	15861.28	2775.72	18637.00	19425.00	154
1.9CDTi 16v (150PS)	16286.81	2850.19	19137.00	19925.00	154
1.9CDTi 16v (150PS) auto	17691.06	3095.94	20787.00	21600.00	184

Please note: On-the-road recommended retail prices (RRP) include number plates and delivery to retailer of £598.00 (inc. £89.06 VAT), 12 months' Vehicle Excise Duty (see page 3) and new vehicle first registration fee of £50.00. Excludes fuel and insurance.

* = CO₂ emission figures. Vehicle Excise Duty is based on CO₂ emissions (see page 3 for details). For benefit in kind taxation charges see page 3.

** = Fitted with CD 70 stereo radio/CD with MP3 capability/satellite navigation with colour monitor.

For details of Vectra VXR please see page 41.



Option availability

	Life	Exclusiv	Design	Elite	Price (£) exc. VAT	Total (£) inc. VAT
Option packs						
Plus Pack • 17-inch alloy wheels (steel space-saver spare) with 215/50 R 17 tyres • CDC 40 stereo radio with Digital Audio Broadcast (DAB)/integral six-disc CD autochanger/graphic display • Front fog lights		○			506.38	595.00
Plus Pack • 17-inch alloy wheels (steel space-saver spare) with 215/50 R 17 tyres • CD 70 stereo radio/CD with MP3 capability/satellite navigation with colour monitor			○		761.70	895.00
Plus Pack • 18-inch alloy wheels (steel space-saver spare) with 225/45 R 18 tyres • Electrically operated slide/tilt glass sunroof with multi-position pre-select facility				○ ¹	638.30	750.00
VXR Styling Pack One (hatch) • Body-colour front lower spoiler/side sills/rear lower skirt and rear spoiler • Visible stainless steel exhaust tailpipe		○	○	○	510.64	600.00
Safety option						
Electronic Stability Programme-plus (ESP-plus) incorporating traction control 1 see page 53	○	○	○	○ ²	340.43	400.00
Mechanical option						
Interactive Driving System-plus (IDS-plus) with Continuous Damping Control (CDC) and Sport switch ³ 1 see page 53		○	○	○	425.53	500.00
Exterior and convenience options						
Electrically operated slide/tilt glass sunroof with multi-position pre-select facility		○ ⁴	○ ⁴	○ ⁴	510.64	600.00
16-inch alloy wheels (steel space-saver spare)	○		●		255.32	300.00
18-inch 11-spoke alloy wheels (steel space-saver spare)			○ ⁵		340.43	400.00
18-inch 11-spoke alloy wheels (steel space-saver spare)				○ ⁵	255.32	300.00
Adaptive Forward Lighting (AFL) incorporating bi-xenon headlights with high-pressure headlight washers 1 see page 52		○	○	○	723.40	850.00
Front and rear parking distance sensors 1 see page 51		○	○	○	361.70	425.00
Two-coat metallic or pearlescent paint	○	○	○	○	297.87	350.00
Audio and communication options						
CDC 40 stereo radio with Digital Audio Broadcast (DAB)/integral six-disc CD autochanger/graphic display	○	○	●	N/C ⁶	382.98	450.00
CD 70 stereo radio/CD with MP3 capability/satellite navigation with colour monitor 1 see page 50	○	○		●	1063.83	1250.00
CD 70 stereo radio/CD with MP3 capability/satellite navigation with colour monitor 1 see page 50			○	●	680.85	800.00
Mobile phone system with Bluetooth® (does not include phone or cradle) ⁷ – see page 60 for details of mobile phone compatibility 1 see page 50	○	○	○	○	255.32	300.00

○ = Optional at extra cost ● = Standard equipment N/C = No-cost option.

1 = Includes sports suspension. Sunroof deletes storage pocket between sunvisors. **2** = ESP-plus incorporating traction control is standard on 2.8i V6 24v Turbo/3.0CDTi V6 24v models. **3** = Available on 2.0i 16v Turbo, 2.2i 16v Direct and 1.9CDTi 16v (150PS) models fitted with optional ESP-plus and V6 models only. **4** = Deletes storage pocket between sunvisors. **5** = Includes sports suspension. **6** = Fitted in lieu of CD 70 audio system. Deletes the satellite navigation function. **7** = Deletes drinks holders in centre console.

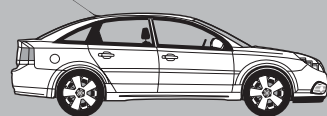

5-door hatchback

Model	Price (£)	VAT (£)	Total (£)	On-the-road RRP (£)	CO ₂ * (g/km)
Vectra SRI					
1.8i 16v VVT	13967.66	2444.34	16412.00	17225.00	173
2.2i 16v Direct	14478.30	2533.70	17012.00	17825.00	180
2.2i 16v Direct auto	15584.68	2727.32	18312.00	19165.00	192
2.0i 16v Turbo	14818.72	2593.28	17412.00	18265.00	206
<i>Diesel</i>					
1.9CDTi (120PS)	15244.26	2667.74	17912.00	18700.00	154
1.9CDTi 16v (150PS)	15669.79	2742.21	18412.00	19200.00	154
1.9CDTi 16v (150PS) auto	17074.04	2987.96	20062.00	20915.00	186
3.0CDTi V6 24v	18222.98	3189.02	21412.00	22265.00	186
3.0CDTi V6 24v auto	19329.36	3382.64	22712.00	23565.00	192
Vectra SRI with Exterior Pack†					
1.8i 16v VVT	14776.17	2585.83	17362.00	18175.00	175
2.2i 16v Direct	15286.81	2675.19	17962.00	18775.00	182
2.2i 16v Direct auto	16393.19	2868.81	19262.00	20115.00	194
2.0i 16v Turbo	15627.23	2734.77	18362.00	19215.00	209
<i>Diesel</i>					
1.9CDTi (120PS)	16052.77	2809.23	18862.00	19650.00	157
1.9CDTi 16v (150PS)	16478.30	2883.70	19362.00	20150.00	157
1.9CDTi 16v (150PS) auto	17882.55	3129.45	21012.00	21865.00	189

Model	Price (£)	VAT (£)	Total (£)	On-the-road RRP (£)	CO ₂ * (g/km)
Vectra SRI Nav**					
1.8i 16v VVT	14605.96	2556.04	17162.00	17975.00	173
2.2i 16v Direct	15116.60	2645.40	17762.00	18575.00	180
2.2i 16v Direct auto	16222.98	2839.02	19062.00	19915.00	192
2.0i 16v Turbo	15457.02	2704.98	18162.00	19015.00	206
<i>Diesel</i>					
1.9CDTi (120PS)	15882.55	2779.45	18662.00	19450.00	154
1.9CDTi 16v (150PS)	16308.09	2853.91	19162.00	19950.00	154
1.9CDTi 16v (150PS) auto	17712.34	3099.66	20812.00	21665.00	186
3.0CDTi V6 24v	18861.28	3300.72	22162.00	23015.00	186
3.0CDTi V6 24v auto	19967.66	3494.34	23462.00	24315.00	192
Vectra SRI Nav** with Exterior Pack†					
1.8i 16v VVT	15414.47	2697.53	18112.00	18925.00	175
2.2i 16v Direct	15925.11	2786.89	18712.00	19525.00	182
2.2i 16v Direct auto	17031.49	2980.51	20012.00	20865.00	194
2.0i 16v Turbo	16265.53	2846.47	19112.00	19965.00	209
<i>Diesel</i>					
1.9CDTi (120PS)	16691.06	2920.94	19612.00	20400.00	157
1.9CDTi 16v (150PS)	17116.60	2995.40	20112.00	20900.00	157
1.9CDTi 16v (150PS) auto	18520.85	3241.15	21762.00	22615.00	189

Please note: On-the-road recommended retail prices (RRP) include number plates and delivery to retailer of £598.00 (inc. £89.06 VAT), 12 months' Vehicle Excise Duty (see page 3) and new vehicle first registration fee of £50.00. Excludes fuel and insurance.

* = CO₂ emission figures. Vehicle Excise Duty is based on CO₂ emissions (see page 3 for details).

For benefit in kind taxation charges see page 3.

** = Fitted with CD 70 stereo radio/CD with MP3 capability/satellite navigation with colour monitor.

† = Exterior Pack comprises 19-inch five-spoke alloy wheels and VXR Styling Pack One (see page 29 for details).

For details of Vectra VXR please see page 41.



Option availability

	SRI	SRI/XP	SRI/Nav	SRI/Nav/XP	Price (£) exc. VAT	Total (£) inc. VAT
Option packs						
Plus Pack ¹ • 19-inch alloy wheels (steel space-saver spare) with 235/35 R 19 tyres • CDC 40 stereo radio with Digital Audio Broadcast (DAB)/integral six-disc CD autochanger/graphic display	○				676.60	795.00
VXR Styling Pack One • Body-colour front lower spoiler/side sills/rear lower skirt and rear spoiler • Visible stainless steel exhaust tailpipe	○	●	○	●	510.64	600.00
Safety option						
Electronic Stability Programme-plus (ESP-plus) incorporating traction control ² ⓘ see page 53	○	○	○	○	340.43	400.00
Mechanical option						
Interactive Driving System-plus (IDS-plus) with Continuous Damping Control (CDC) and Sport switch ³ ⓘ see page 53	○	○	○	○	425.53	500.00
Exterior and convenience options						
Electrically operated slide/tilt glass sunroof with multi-position pre-select facility ⁴	○	○	○	○	510.64	600.00
19-inch five-spoke alloy wheels (steel space-saver spare) ¹	○	●	○	●	340.43	400.00
Adaptive Forward Lighting (AFL) incorporating bi-xenon headlights with high-pressure headlight washers ⓘ see page 52	○	○	○	○	723.40	850.00
Front and rear parking distance sensors ⓘ see page 51	○	○	○	○	361.70	425.00
Two-coat metallic or pearlescent paint	○	○	○	○	297.87	350.00
Audio and communication options						
CDC 40 stereo radio with Digital Audio Broadcast (DAB)/integral six-disc CD autochanger/graphic display	○	○			382.98	450.00
CD 70 stereo radio/CD with MP3 capability/satellite navigation with colour monitor ⓘ see page 50	○	○	●	●	1063.83	1250.00
Mobile phone system with Bluetooth® (does not include phone or cradle) ⁵ – see page 60 for details of mobile phone compatibility ⓘ see page 50	○	○	○	○	255.32	300.00

○ = Optional at extra cost ● = Standard equipment XP = Models with Exterior Pack.

¹ = Not available on 3.0CDTi V6 24v models. Due to increased CO₂ emissions, on certain engines there will be a slight increase in benefit in kind charges for company car drivers. CO₂ emissions figures: 1.8i 16v VVT (hatch) – 175g/km; 1.9CDTi (120PS) (hatch) – 157g/km; 1.9CDTi 16v (150PS) (manual hatch) – 157g/km. ² = ESP-plus incorporating traction control is standard on 2.8i V6 24v Turbo/3.0CDTi V6 24v models. ³ = Available on 2.0i 16v Turbo, 2.2i 16v Direct and 1.9CDTi 16v (150PS) models fitted with optional ESP-plus or V6 models only. ⁴ = Deletes storage pocket between sunvisors. ⁵ = Deletes drinks holders in centre console.



Model	Price (£)	VAT (£)	Total (£)	On-the-road RRP (£)	CO ₂ * (g/km)
Vectra Life					
1.8i 16v VVT	14116.60	2470.40	16587.00	17400.00	180
<i>Diesel</i>					
1.9CDTi (120PS)	15691.06	2745.94	18437.00	19225.00	157
1.9CDTi 16v (150PS)	16116.60	2820.40	18937.00	19725.00	157
1.9CDTi 16v (150PS) auto	17222.98	3014.02	20237.00	21090.00	189
Vectra Exclusiv					
1.8i 16v VVT	12925.11	2261.89	15187.00	16000.00	180
<i>Diesel</i>					
1.9CDTi (120PS)	14074.04	2462.96	16537.00	17325.00	157
1.9CDTi 16v (150PS)	14499.57	2537.43	17037.00	17825.00	157
1.9CDTi 16v (150PS) auto	15605.96	2731.04	18337.00	19190.00	189
Vectra Design					
1.8i 16v VVT	15520.85	2716.15	18237.00	19050.00	180
2.2i 16v Direct	16031.49	2805.51	18837.00	19690.00	187
2.2i 16v Direct auto	17137.87	2999.13	20137.00	20990.00	197
<i>Diesel</i>					
1.9CDTi (120PS)	17095.32	2991.68	20087.00	20875.00	157
1.9CDTi 16v (150PS)	17520.85	3066.15	20587.00	21375.00	157
1.9CDTi 16v (150PS) auto	18627.23	3259.77	21887.00	22740.00	189

Model	Price (£)	VAT (£)	Total (£)	On-the-road RRP (£)	CO ₂ * (g/km)
Vectra Elite Nav**					
2.2i 16v Direct	18031.49	3155.51	21187.00	22040.00	187
2.2i 16v Direct auto	19137.87	3349.13	22487.00	23340.00	197
2.8i V6 24v Turbo auto	20882.55	3654.45	24537.00	25485.00	269
<i>Diesel</i>					
1.9CDTi 16v (150PS)	19520.85	3416.15	22937.00	23725.00	157
1.9CDTi 16v (150PS) auto	20627.23	3609.77	24237.00	25090.00	189
3.0CDTi V6 24v	21776.17	3810.83	25587.00	26440.00	186
3.0CDTi V6 24v auto	22882.55	4004.45	26887.00	27740.00	194

Please note: On-the-road recommended retail prices (RRP) include number plates and delivery to retailer of £598.00 (inc. £89.06 VAT), 12 months' Vehicle Excise Duty (see page 3) and new vehicle first registration fee of £50.00. Excludes fuel and insurance.

* = CO₂ emission figures. Vehicle Excise Duty is based on CO₂ emissions (see page 3 for details). For benefit in kind taxation charges see page 3.

** = Fitted with CD 70 stereo radio/CD with MP3 capability/satellite navigation with colour monitor.

Option availability

	Life	Exclusiv	Design	Elite	Price (£) exc. VAT	Total (£) inc. VAT
Option packs						
Plus Pack • 17-inch alloy wheels (steel space-saver spare) with 215/50 R 17 tyres • CDC 40 stereo radio with Digital Audio Broadcast (DAB)/integral six-disc CD autochanger/graphic display • Front fog lights		○			506.38	595.00
Plus Pack • 17-inch alloy wheels (steel space-saver spare) with 215/50 R 17 tyres • CD 70 stereo radio/CD with MP3 capability/satellite navigation with colour monitor 1 see page 50			○		761.70	895.00
Plus Pack • 18-inch alloy wheels (steel space-saver spare) with 225/45 R 18 tyres • Electrically operated slide/tilt glass sunroof with multi-position pre-select facility				○ ¹	638.30	750.00
VXR Styling Pack One • Body-colour front lower spoiler/side sills/rear lower skirt and rear spoiler		○	○	○	510.64	600.00
Towing Pack • Electronic Stability Programme-plus (ESP-plus) incorporating traction control 1 see page 53 • Trailer stability programme • Automatic self-levelling rear suspension ² • Retractable tow bar ³	○	○	○	○ ⁴	595.74	700.00
FlexOrganiser® option pack						
Organiser Pack • 3D storage net • Side net pocket • Four side rail hooks	○	○	○	○	42.55	50.00
Safety option						
Electronic Stability Programme-plus (ESP-plus) incorporating traction control 1 see page 53	○	○	○	○ ⁴	340.43	400.00
Interior option						
Vertical load-restraining net ⁵	○	○	○	○	127.66	150.00
Mechanical option						
Interactive Driving System-plus (IDS-plus) with Continuous Damping Control (CDC) and Sport switch ⁶ 1 see page 53		○	○	○	425.53	500.00
Exterior and convenience options						
Electrically operated slide/tilt glass sunroof with multi-position pre-select facility		○ ⁷	○ ⁷	○ ⁷	510.64	600.00
16-inch alloy wheels (steel space-saver spare)	○		●		255.32	300.00
18-inch 11-spoke alloy wheels (steel space-saver spare)			○ ⁸		340.43	400.00
18-inch 11-spoke alloy wheels (steel space-saver spare)				○ ⁸	255.32	300.00
Adaptive Forward Lighting (AFL) incorporating bi-xenon headlights with high-pressure headlight washers 1 see page 52		○	○	○	723.40	850.00
Roof rails ⁹	○	○	○	●	85.11	100.00
Front and rear parking distance sensors 1 see page 51		○	○	○	361.70	425.00
Two-coat metallic or pearlescent paint	○	○	○	○	297.87	350.00
Audio and communication options						
CDC 40 stereo radio with Digital Audio Broadcast (DAB)/integral six-disc CD autochanger/graphic display	○	○	●	N/C ¹⁰	382.98	450.00
CD 70 stereo radio/CD with MP3 capability/satellite navigation with colour monitor 1 see page 50	○	○		●	1063.83	1250.00
CD 70 stereo radio/CD with MP3 capability/satellite navigation with colour monitor 1 see page 50			○	●	680.85	800.00
Mobile phone system with Bluetooth® (does not include phone or cradle) ¹¹ – see page 60 for details of mobile phone compatibility 1 see page 50	○	○	○	○	255.32	300.00

○ = Optional at extra cost. ● = Standard equipment. N/C = No-cost option.

1 = Includes sports suspension. Sunroof deletes storage pocket between sunvisors. **2** = Not available on Exclusiv, Design or Elite models with optional IDS-plus or 18-inch alloy wheels. **3** = Please note: a separate electrical adaptor (13-pin) is required – available as an accessory at extra cost. This adaptor does not allow for supplementary trailer power requirements. **4** = ESP-plus incorporating traction control is standard on 2.8i V6 24v Turbo/3.0CDTi V6 24v models.

5 = Includes fixing points for accessory dog guard. **6** = Available on 2.0i 16v Turbo, 2.2i 16v Direct and 1.9CDTi 16v (150PS) models fitted with optional ESP-plus or Towing Pack and V6 models only. **7** = Deletes storage pocket between sunvisors.

8 = Includes sports suspension. **9** = Must be used with separate base carrier (available as a Vauxhall accessory) if luggage is to be carried on the roof. **10** = Fitted in lieu of CD 70 audio system. Deletes the satellite navigation function. **11** = Deletes drinks holders in centre console.

5-door estate

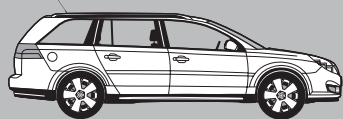

Model	Price (£)	VAT (£)	Total (£)	On-the-road RRP (£)	CO ₂ * (g/km)
Vectra SRI					
1.8i 16v VVT	14903.83	2608.17	17512.00	18325.00	180
2.2i 16v Direct	15414.47	2697.53	18112.00	18965.00	187
2.2i 16v Direct auto	16520.85	2891.15	19412.00	20265.00	197
2.0i 16v Turbo	15754.89	2757.11	18512.00	19365.00	211
<i>Diesel</i>					
1.9CDTi (120PS)	16478.30	2883.70	19362.00	20150.00	157
1.9CDTi 16v (150PS)	16903.83	2958.17	19862.00	20650.00	157
1.9CDTi 16v (150PS) auto	18010.21	3151.79	21162.00	22015.00	189
3.0CDTi V6 24v	19159.15	3352.85	22512.00	23365.00	186
3.0CDTi V6 24v auto	20265.53	3546.47	23812.00	24665.00	194
Vectra SRI with Exterior Pack†					
1.8i 16v VVT	15712.34	2749.66	18462.00	19275.00	182
2.2i 16v Direct	16222.98	2839.02	19062.00	19915.00	190
2.2i 16v Direct auto	17329.36	3032.64	20362.00	21215.00	199
2.0i 16v Turbo	16563.40	2898.60	19462.00	20315.00	214
<i>Diesel</i>					
1.9CDTi (120PS)	17286.81	3025.19	20312.00	21100.00	159
1.9CDTi 16v (150PS)	17712.34	3099.66	20812.00	21600.00	159
1.9CDTi 16v (150PS) auto	18818.72	3293.28	22112.00	22965.00	192

Model	Price (£)	VAT (£)	Total (£)	On-the-road RRP (£)	CO ₂ * (g/km)
Vectra SRI Nav**					
1.8i 16v VVT	15542.13	2719.87	18262.00	19075.00	180
2.2i 16v Direct	16052.77	2809.23	18862.00	19715.00	187
2.2i 16v Direct auto	17159.15	3002.85	20162.00	21015.00	197
2.0i 16v Turbo	16393.19	2868.81	19262.00	20115.00	211
<i>Diesel</i>					
1.9CDTi (120PS)	17116.60	2995.40	20112.00	20900.00	157
1.9CDTi 16v (150PS)	17542.13	3069.87	20612.00	21400.00	157
1.9CDTi 16v (150PS) auto	18648.51	3263.49	21912.00	22765.00	189
3.0CDTi V6 24v	19797.45	3464.55	23262.00	24115.00	186
3.0CDTi V6 24v auto	20903.83	3658.17	24562.00	25415.00	194
Vectra SRI Nav** with Exterior Pack†					
1.8i 16v VVT	16350.64	2861.36	19212.00	20025.00	182
2.2i 16v Direct	16861.28	2950.72	19812.00	20665.00	190
2.2i 16v Direct auto	17967.66	3144.34	21112.00	21965.00	199
2.0i 16v Turbo	17201.70	3010.30	20212.00	21065.00	214
<i>Diesel</i>					
1.9CDTi (120PS)	17925.11	3136.89	21062.00	21850.00	159
1.9CDTi 16v (150PS)	18350.64	3211.36	21562.00	22350.00	159
1.9CDTi 16v (150PS) auto	19457.02	3404.98	22862.00	23715.00	192

Please note: On-the-road recommended retail prices (RRP) include number plates and delivery to retailer of £598.00 (inc. £89.06 VAT), 12 months' Vehicle Excise Duty (see page 3) and new vehicle first registration fee of £50.00. Excludes fuel and insurance.

* = CO₂ emission figures. Vehicle Excise Duty is based on CO₂ emissions (see page 3 for details).

For benefit in kind taxation charges see page 3.

** = Fitted with CD 70 stereo radio/CD with MP3 capability/satellite navigation with colour monitor.

† = Exterior Pack comprises 19-inch five-spoke alloy wheels and VXR Styling Pack One (see page 33 for details).

For details of Vectra VXR please see page 41.



Option availability

	SRI	SRI:XP	SRI:Nav	SRI:Nav:XP	Price (£) exc. VAT	Total (£) inc. VAT
Option packs						
Plus Pack ¹ • 19-inch alloy wheels (steel space-saver spare) with 235/35 R 19 tyres • CDC 40 stereo radio with Digital Audio Broadcast (DAB)/integral six-disc CD autochanger/graphic display	○				676.60	795.00
VXR Styling Pack One • Body-colour front lower spoiler/side sills/rear lower skirt and rear spoiler • Visible stainless steel exhaust tailpipe	○	●	○	●	510.64	600.00
Towing Pack • Electronic Stability Programme-plus (ESP-plus) incorporating traction control ² ⓘ see page 53 • Trailer stability programme • Retractable tow bar ³	○	○	○	○	595.74	700.00
FlexOrganiser® option pack						
Organiser Pack • 3D storage net • Side net pocket • Four side rail hooks	○	○	○	○	42.55	50.00
Safety option						
Electronic Stability Programme-plus (ESP-plus) incorporating traction control ² ⓘ see page 53	○	○	○	○	340.43	400.00
Interior option						
Vertical load-restraining net ⁴	○	○	○	○	127.66	150.00
Mechanical option						
Interactive Driving System-plus (IDS-plus) with Continuous Damping Control (CDC) and Sport switch ⁵ ⓘ see page 53	○	○	○	○	425.53	500.00
Exterior and convenience options						
Electrically operated slide/tilt glass sunroof with multi-position pre-select facility ⁶	○	○	○	○	510.64	600.00
19-inch five-spoke alloy wheels (steel space-saver spare) ¹	○	●	○	●	340.43	400.00
Adaptive Forward Lighting (AFL) incorporating bi-xenon headlights with high-pressure headlight washers ⓘ see page 52	○	○	○	○	723.40	850.00
Roof rails (estate only) ⁷	○	○	○	○	85.11	100.00
Front and rear parking distance sensors ⓘ see page 51	○	○	○	○	361.70	425.00
Two-coat metallic or pearlescent paint	○	○	○	○	297.87	350.00
Audio and communication options						
CDC 40 stereo radio with Digital Audio Broadcast (DAB)/integral six-disc CD autochanger/graphic display	○	○			382.98	450.00
CD 70 stereo radio/CD with MP3 capability/satellite navigation with colour monitor ⓘ see page 50	○	○	●	●	1063.83	1250.00
Mobile phone system with Bluetooth® (does not include phone or cradle) ⁸ – see page 60 for details of mobile phone compatibility ⓘ see page 50	○	○	○	○	255.32	300.00

○ = Optional at extra cost. ● = Standard equipment. XP = Models with Exterior Pack.

¹ = Not available on 3.0CDTi V6 24v models. Due to increased CO₂ emissions, on certain engines there will be a slight increase in benefit in kind charges for company car drivers. CO₂ emissions figures: 2.2i 16v Direct (manual estate) – 190g/km; 1.9CDTi 16v (150PS) (automatic estate) – 192g/km. ² = ESP-plus incorporating traction control is standard on 2.8i V6 24v Turbo/3.0CDTi V6 24v models. ³ = Please note: a separate electrical adaptor (13-pin to 7-pin) is required – available as an accessory at extra cost. This adaptor does not allow for supplementary trailer power requirements. ⁴ = Includes fixing points for accessory dog guard. ⁵ = Available on 2.0i 16v Turbo, 2.2i 16v Direct and 1.9CDTi 16v (150PS) models fitted with optional ESP-plus or Towing Pack and V6 models only. ⁶ = Deletes storage pocket between sunvisors. ⁷ = Must be used with separate base carrier (available as a Vauxhall accessory) if luggage is to be carried on the roof. ⁸ = Deletes drinks holders in centre console.

5-door hatchback

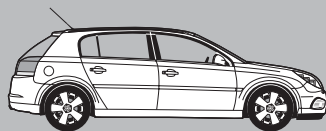

Model	Price (£)	VAT (£)	Total (£)	On-the-road RRP (£)	CO ₂ * (g/km)
Signum Elegance Nav**					
1.8i 16v VVT	15516.60	2715.40	18232.00	19045.00	180
2.2i 16v Direct	16027.23	2804.77	18832.00	19685.00	194
2.2i 16v Direct auto	17133.62	2998.38	20132.00	20985.00	199
2.0i 16v Turbo	16537.87	2894.13	19432.00	20285.00	214
<i>Diesel</i>					
1.9CDTi (120PS)	17091.06	2990.94	20082.00	20870.00	159
1.9CDTi 16v (150PS)	17516.60	3065.40	20582.00	21370.00	159
1.9CDTi 16v (150PS) auto	18622.98	3259.02	21882.00	22735.00	189
Signum Exclusiv Nav**					
1.8i 16v VVT	14797.45	2589.55	17387.00	18200.00	180
2.2i 16v Direct	15308.09	2678.91	17987.00	18840.00	194
2.2i 16v Direct auto	16414.47	2872.53	19287.00	20140.00	199
<i>Diesel</i>					
1.9CDTi (120PS)	16371.91	2865.09	19237.00	20025.00	159
1.9CDTi 16v (150PS)	16797.45	2939.55	19737.00	20525.00	159
1.9CDTi 16v (150PS) auto	17903.83	3133.17	21037.00	21890.00	189
Signum Design Nav**					
2.2i 16v Direct	16614.47	2907.53	19522.00	20375.00	194
2.2i 16v Direct auto	17720.85	3101.15	20822.00	21675.00	199
2.0i 16v Turbo	17125.11	2996.89	20122.00	20975.00	214
2.8i V6 24v Turbo	18916.60	3310.40	22227.00	23175.00	254
<i>Diesel</i>					
1.9CDTi (120PS)	17678.30	3093.70	20772.00	21560.00	159
1.9CDTi 16v (150PS)	18103.83	3168.17	21272.00	22060.00	159
1.9CDTi 16v (150PS) auto	19210.21	3361.79	22572.00	23425.00	189
3.0CDTi V6 24v	20359.15	3562.85	23922.00	24775.00	189
3.0CDTi V6 24v auto	21465.53	3756.47	25222.00	26075.00	194

Model	Price (£)	VAT (£)	Total (£)	On-the-road RRP (£)	CO ₂ * (g/km)
Signum Elite Nav**					
2.2i 16v Direct	18699.57	3272.43	21972.00	22825.00	194
2.2i 16v Direct auto	19805.96	3466.04	23272.00	24125.00	199
2.0i 16v Turbo	19210.21	3361.79	22572.00	23425.00	214
2.8i V6 24v Turbo auto	21052.77	3684.23	24737.00	25685.00	269
<i>Diesel</i>					
1.9CDTi 16v (150PS)	20188.94	3533.06	23722.00	24510.00	159
1.9CDTi 16v (150PS) auto	21295.32	3726.68	25022.00	25875.00	189
3.0CDTi V6 24v	22444.26	3927.74	26372.00	27225.00	189
3.0CDTi V6 24v auto	23550.64	4121.36	27672.00	28525.00	194

Please note: On-the-road recommended retail prices (RRP) include number plates and delivery to retailer of £598.00 (inc. £89.06 VAT), 12 months' Vehicle Excise Duty (see page 3) and new vehicle first registration fee of £50.00. Excludes fuel and insurance.

* = CO₂ emission figures. Vehicle Excise Duty is based on CO₂ emission (see page 3 for details).

For benefit in kind taxation charges see page 3.

** = Fitted with CD 70 stereo radio/CD with MP3 capability/satellite navigation with colour monitor.

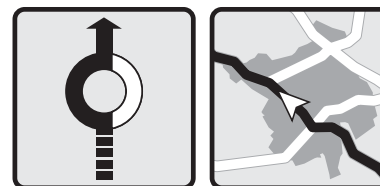

All Signum models feature satellite navigation with colour monitor as standard.

Option availability

	Elegance	Exclusiv	Design	Elite	Price (£) exc. VAT	Total (£) inc. VAT
Safety option						
Electronic Stability Programme-plus (ESP-plus) incorporating traction control i see page 53	○	○	○ ¹	○ ¹	340.43	400.00
Mechanical option						
Interactive Driving System-plus (IDS-plus) with Continuous Damping Control (CDC) and Sport switch ² i see page 53	○	○	○	○	425.53	500.00
Exterior and convenience options						
Electrically operated slide/tilt glass sunroof with multi-position pre-select facility and interior blind ³	○	○	○	○	510.64	600.00
Adaptive Forward Lighting (AFL) incorporating bi-xenon headlights with high-pressure headlight washers i see page 52	○	○	○	○	723.40	850.00
18-inch multi-spoke alloy wheels (steel space-saver spare) ⁴				○	255.32	300.00
18-inch 11-spoke alloy wheels (steel space-saver spare) ⁴	○	●			255.32	300.00
19-inch five-spoke alloy wheels (steel space-saver spare) ⁵			○ ⁶		340.43	400.00
Roof rails ⁷	○	●	○	●	85.11	100.00
Front and rear parking distance sensors i see page 51	○	○	○	○	361.70	425.00
Two-coat metallic or pearlescent paint	○	●	○	○	297.87	350.00
Audio and communication options						
CDC 40 stereo radio with Digital Audio Broadcast (DAB)/integral six-disc CD autochanger/graphic display ⁸	N/C	N/C	N/C	N/C	No-cost option	
Mobile phone system with Bluetooth® (does not include phone or cradle) ⁹ – see page 60 for details of mobile phone compatibility i see page 50	○	○	○	○	255.32	300.00

○ = Optional at extra cost. ● = Standard equipment. N/C = No-cost option.

¹ = ESP-plus incorporating traction control is standard on 2.8i V6 24v Turbo/3.0CDTi V6 24v models. ² = Available on 2.0i 16v Turbo, 2.2i 16v Direct and 1.9CDTi 16v (150PS) models fitted with optional ESP-plus and V6 models only. ³ = Deletes storage pocket between sunvisors. ⁴ = Includes sports suspension. ⁵ = Due to increased CO₂ emissions when fitted with 19-inch alloy wheels, on certain engines there will be a slight increase in benefit in kind charges for company car drivers. CO₂ emissions figures: 2.2i 16v Direct (manual) – 197g/km; 2.2i 16v Direct (automatic) – 202g/km; 2.0i 16v Turbo – 216g/km; 1.9CDTi (120PS)/1.9CDTi 16v (150PS) (manual) – 162g/km; 1.9CDTi 16v (150PS) (automatic) – 192g/km. ⁶ = Not available on 3.0CDTi V6 24v model. ⁷ = Must be used with separate base carrier (available as a Vauxhall accessory) if luggage is to be carried on the roof. ⁸ = Fitted in lieu of CD 70 audio system. Deletes the satellite navigation function. ⁹ = Deletes drinks holders in centre console.



5-door SUV

Model	Price (£)	VAT (£)	Total (£)	On-the-road RRP (£)	CO ₂ * (g/km)
Antara E					
2.4i 16v	16176.17	2830.83	19007.00	19955.00	229
<i>Diesel</i>					
2.0CDTi 16v	17163.40	3003.60	20167.00	21020.00	198
2.0CDTi 16v auto	18337.87	3209.13	21547.00	22495.00	238
Antara S					
<i>Diesel</i>					
2.0CDTi 16v	18525.11	3241.89	21767.00	22620.00	198
2.0CDTi 16v auto	19699.57	3447.43	23147.00	24095.00	238
Antara SE					
<i>Diesel</i>					
2.0CDTi 16v	21674.04	3792.96	25467.00	26320.00	198
2.0CDTi 16v auto	22848.51	3998.49	26847.00	27795.00	238

Please note: On-the-road recommended retail prices (RRP) include number plates and delivery to retailer of £598.00 (inc. £89.06 VAT), 12 months' Vehicle Excise Duty (see page 3) and new vehicle first registration fee of £50.00. Excludes fuel and insurance.

* = CO₂ emission figure. Vehicle Excise Duty is based on CO₂ emissions (see page 3 for details). For benefit in kind taxation charges see page 3.

Option availability

	Antara E	Antara S	Antara SE	Price (£) exc. VAT	Total (£) inc. VAT
Exterior option					
Two-coat metallic or pearlescent paint	<input type="radio"/>	<input type="radio"/>	<input type="radio"/>	340.43	400.00

O = Optional at extra cost.

Accessories

	Price (£) exc. VAT	Total (£) inc. VAT
Interior		
Rubber mats (set of four)	31.05	36.48
Velour mats (set of four)	39.45	46.35
FlexOrganiser® divider mesh	69.50	81.66
Reversible anti-slip cargo liner	62.00	72.85
Cargo liner	62.00	72.85
Security net for luggage compartment	121.00	142.18
Sunshades – rear doors (pair)	47.25	55.52
Sunshades – tailgate and side glass set	59.00	69.33
Exterior		
Mudflaps – front pair (excludes fitting)	12.95	15.22
Mudflaps – rear pair (excludes fitting)	12.95	15.22
Door wind deflectors	24.70	29.02
Locking wheel nuts	31.70	37.25
Towing/Load carrier		
Detachable tow bar (excludes electrics/fitting)	334.00	392.45
Towing electrical kit – 13-pin	86.50	101.64
Towing electrical kit – 7-pin (12N)	86.50	101.64
Base carrier – aluminium	109.00	128.08

For additional Antara accessories and styling products see pages 54-61.

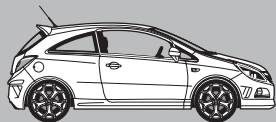

3-door hatchback

Model	Price (£)	VAT (£)	Total (£)	On-the-road RRP (£)	CO ₂ * (g/km)
Corsa VXR					
1.6i 16v Turbo (192PS)	12571.91	2200.09	14772.00	15625.00	190

Please note: On-the-road recommended retail prices (RRP) include number plates and delivery to retailer of £598.00 (inc. £89.06 VAT), 12 months' Vehicle Excise Duty (see page 3) and new vehicle first registration fee of £50.00. Excludes fuel and insurance.

* = CO₂ emission figure. Vehicle Excise Duty is based on CO₂ emissions (see page 3 for details). For benefit in kind taxation charges see page 3.

Option availability

	VXR	Price (£) exc. VAT	Total (£) inc. VAT
Option packs			
Leather Pack • Leather seat facings • Electrically heated Recaro shell-backed sports front seats	<input type="radio"/>	851.06	1000.00
Sight and Light Pack • Rain-sensitive windscreen wipers • Electro-chromatic anti-dazzle rear-view mirror • Automatic lighting control	<input type="radio"/>	127.66	150.00
Interior option			
Electronic Climate Control (ECC) incorporating air conditioning i see page 52	<input type="radio"/>	234.04	275.00
Exterior and convenience options			
18-inch V-spoke alloy wheels with 225/35 R 18 ultra-low profile tyres	<input type="radio"/>	340.43	400.00
Adaptive Forward Lighting (AFL) – halogen i see page 52	<input type="radio"/>	212.77	250.00
Two-coat metallic or pearlescent paint	<input type="radio"/>	297.87	350.00
Audio and communication options			
CD 60 stereo radio/CD with MP3 capability/satellite navigation with graphic display	<input type="radio"/>	829.79	975.00
Mobile phone system with Bluetooth® (does not include phone or cradle) – see page 60 for details of mobile phone compatibility i see page 50	<input type="radio"/>	255.32	300.00

○ = Optional at extra cost.



5-door MPV

Model	Price (£)	VAT (£)	Total (£)	On-the-road RRP (£)	CO ₂ * (g/km)
Meriva VXR					
1.6i 16v Turbo (180PS)	13376.17	2340.83	15717.00	16570.00	187

Please note: On-the-road recommended retail prices (RRP) include number plates and delivery to retailer of £598.00 (inc. £89.06 VAT), 12 months' Vehicle Excise Duty (see page 3) and new vehicle first registration fee of £50.00. Excludes fuel and insurance.

* = CO₂ emission figure. Vehicle Excise Duty is based on CO₂ emissions (see page 3 for details). For benefit in kind taxation charges see page 3.

Option availability

	VXR	Price (£) exc. VAT	Total (£) inc. VAT
Option pack			
Leather Pack • Leather seat facings • Electrically heated Recaro sports front seats	<input type="radio"/>	851.06	1000.00
Exterior and convenience options			
Adaptive Forward Lighting (AFL) – halogen ⓘ see page 52	<input type="radio"/>	212.77	250.00
Two-coat metallic or pearlescent paint	<input type="radio"/>	297.87	350.00
Audio and communication options			
CD 70 stereo radio/CD with MP3 capability/satellite navigation with graphic display ⓘ see page 50	<input type="radio"/>	1021.28	1200.00
Rear seat Twin Audio® system with single headset ⓘ see page 50	<input type="radio"/>	85.11	100.00
Mobile phone system with Bluetooth® (does not include phone or cradle) – see page 60 for details of mobile phone compatibility ⓘ see page 50	<input type="radio"/>	255.32	300.00

○ = Optional at extra cost.

3-door hatchback

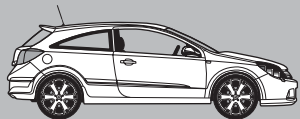

Model	Price (£)	VAT (£)	Total (£)	On-the-road RRP (£)	CO ₂ * (g/km)
Astra VXR					
2.0i 16v Turbo (240PS)	15601.70	2730.30	18332.00	19185.00	221

Please note: On-the-road recommended retail prices (RRP) include number plates and delivery to retailer of £598.00 (inc. £89.06 VAT), 12 months' Vehicle Excise Duty (see page 3) and new vehicle first registration fee of £50.00. Excludes fuel and insurance.

* = CO₂ emission figure. Vehicle Excise Duty is based on CO₂ emissions (see page 3 for details). For benefit in kind taxation charges see page 3.

Option availability

	VXR	Price (£) exc. VAT	Total (£) inc. VAT
Option packs			
Leather Pack • Leather seat facings • Electrically heated Recaro sports front seats • Indirect door night lighting • Centre rear seat head restraint • Front passenger's seat height adjuster	<input type="radio"/>	851.06	1000.00
Sight and Light Pack • Rain-sensitive windscreen wipers • Electro-chromatic anti-dazzle rear-view mirror • Automatic lighting control	<input type="radio"/>	127.66	150.00
Security option			
Keyless entry and start i see page 51	<input type="radio"/>	255.32	300.00
Interior options			
Electronic Climate Control (ECC) incorporating air conditioning i see page 52	<input type="radio"/>	234.04	275.00
Cruise control	<input type="radio"/>	170.21	200.00
Mechanical options			
Interactive Driving System-plus (IDS-plus) with Continuous Damping Control (CDC) i see page 53	<input type="radio"/>	340.43	400.00
Stainless steel sports exhaust system incorporating performance centre and rear silencers and connecting pipe including hi-flow catalytic converter and downpipe – retailer-fit (excluding fitting)	<input type="radio"/>	974.47	1145.00
Exterior and convenience options			
Electrically foldable door mirrors	<input type="radio"/>	106.38	125.00
Adaptive Forward Lighting (AFL) incorporating bi-xenon headlights with dynamic beam levelling and high-pressure washers i see page 52	<input type="radio"/>	638.30	750.00
19-inch multi-spoke alloy wheels with 235/35 R 19 ultra-low profile tyres	<input type="radio"/>	510.64	600.00
Rear parking distance sensor i see page 51	<input type="radio"/>	297.87	350.00
Two-coat metallic or pearlescent paint	<input type="radio"/>	297.87	350.00
Audio and communication options			
CD 70 stereo radio/CD with MP3 capability/satellite navigation with colour monitor i see page 50	<input type="radio"/>	1063.83	1250.00
Mobile phone system with Bluetooth® (does not include phone or cradle) – see page 60 for details of mobile phone compatibility i see page 50	<input type="radio"/>	255.32	300.00

○ = Optional at extra cost.

5-door MPV

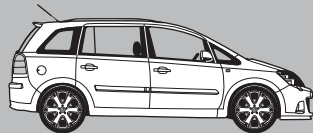

Model	Price (£)	VAT (£)	Total (£)	On-the-road RRP (£)	CO ₂ * (g/km)
Zafira VXR					
2.0i 16v Turbo (240PS)	18146.38	3175.62	21322.00	22270.00	230

Please note: On-the-road recommended retail prices (RRP) include number plates and delivery to retailer of £598.00 (inc. £89.06 VAT), 12 months' Vehicle Excise Duty (see page 3) and new vehicle first registration fee of £50.00. Excludes fuel and insurance.

* = CO₂ emission figure. Vehicle Excise Duty is based on CO₂ emissions (see page 3 for details). For benefit in kind taxation charges see page 3.

Option availability

	VXR	Price (£) exc. VAT	Total (£) inc. VAT
Option packs			
Leather Pack¹ • Leather seat facings • Electrically heated Recaro sports front seats with tilt and lumbar adjustment • Front passenger's seat height adjuster • Centre rear seat head restraint	<input type="radio"/>	851.06	1000.00
Sight and Light Pack • Rain-sensitive windscreen wipers • Electro-chromatic anti-dazzle rear-view mirror • Automatic lighting control	<input type="radio"/>	127.66	150.00
FlexOrganiser® option pack			
Organiser Pack • 3D storage net • Side net pocket • Four side rail hooks	<input type="radio"/>	42.55	50.00
Security option			
Keyless entry and start 1 see page 51	<input type="radio"/>	255.32	300.00
Interior options			
Electronic Climate Control (ECC) 1 see page 52	<input type="radio"/>	234.04	275.00
Cruise control	<input type="radio"/>	170.21	200.00
Mechanical option			
Stainless steel sports exhaust system incorporating performance centre and rear silencers and connecting pipe including hi-flow catalytic converter and downpipe – retailer-fit (excluding fitting)	<input type="radio"/>	974.47	1145.00
Exterior and convenience options			
Electrically foldable door mirrors	<input type="radio"/>	106.38	125.00
Adaptive Forward Lighting (AFL) incorporating bi-xenon headlights with dynamic beam levelling and high-pressure washers 1 see page 52	<input type="radio"/>	638.30	750.00
Alloy-effect roof rails ²	<input type="radio"/>	85.11	100.00
19-inch multi-spoke alloy wheels with 235/35 R 19 ultra-low profile tyres	<input type="radio"/>	510.64	600.00
Front and rear parking distance sensors 1 see page 51	<input type="radio"/>	297.87	350.00
Two-coat metallic or pearlescent paint	<input type="radio"/>	297.87	350.00
Audio and communication options			
CD 70 stereo radio/CD with MP3 capability/satellite navigation with colour monitor 1 see page 50	<input type="radio"/>	1063.83	1250.00
Roof-mounted removable DVD player (retailer-fit) 1 see page 51	<input type="radio"/>	632.23	742.87
Rear seat Twin Audio® system with single headset 1 see page 50	<input type="radio"/>	85.11	100.00
Mobile phone system with Bluetooth® (does not include phone or cradle) – see page 60 for details of mobile phone compatibility 1 see page 50	<input type="radio"/>	255.32	300.00

O = Optional at extra cost.

1 = Deletes front passenger's underseat storage tray. **2** = Must be used with separate base carrier (available as a Vauxhall accessory) if luggage is to be carried on the roof.

5-door hatchback/estate

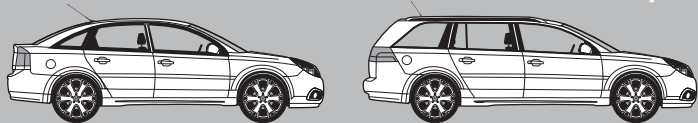

Model	Price (£)	VAT (£)	Total (£)	On-the-road RRP (£)	CO ₂ * (g/km)
Vectra VXR 5-door hatchback					
2.8iV6 24v Turbo (280PS)	20061.28	3510.72	23572.00	24520.00	250
Vectra VXR 5-door estate					
2.8iV6 24v Turbo (280PS)	20997.45	3674.55	24672.00	25620.00	252

Please note: On-the-road recommended retail prices (RRP) include number plates and delivery to retailer of £598.00 (inc. £89.06 VAT), 12 months' Vehicle Excise Duty (see page 3) and new vehicle first registration fee of £50.00. Excludes fuel and insurance.

* = CO₂ emission figure. Vehicle Excise Duty is based on CO₂ emissions (see page 3 for details). For benefit in kind taxation charges see page 3.

Option availability

	VXR	Price (£) exc. VAT	Total (£) inc. VAT
Option packs			
Leather Pack • Leather seat facings • Electrically heated Recaro sports front seats • Eight-way electrical adjustment for driver's and front passenger's seats	<input type="radio"/>	1276.60	1500.00
Towing Pack¹ (estate) • Trailer stability programme • Retractable tow bar	<input type="radio"/>	595.74	700.00
FlexOrganiser® option pack (estate only)			
Organiser Pack • 3D storage net • Side net pocket • Four side rail hooks	<input type="radio"/>	42.55	50.00
Interior option			
Electronic Climate Control (ECC) incorporating air conditioning i see page 52	<input type="radio"/>	234.04	275.00
Mechanical option			
Stainless steel sports exhaust system incorporating performance centre and rear silencers and connecting pipe – retailer-fit (excluding fitting)	<input type="radio"/>	595.75	700.00
Exterior and convenience options			
19-inch multi-spoke alloy wheels with 235/35 R 19 ultra-low profile tyres	<input type="radio"/>	510.64	600.00
Adaptive Forward Lighting (AFL) incorporating bi-xenon headlights with beam levelling and high-pressure headlight washers i see page 52	<input type="radio"/>	723.40	850.00
Power tailgate (estate only)	<input type="radio"/>	425.53	500.00
Alloy-effect roof rails (estate only) ²	<input type="radio"/>	85.11	100.00
Front and rear parking distance sensors i see page 51	<input type="radio"/>	361.70	425.00
Two-coat metallic or pearlescent paint	<input type="radio"/>	297.87	350.00
Audio and communication options			
CD 70 stereo radio/CD with MP3 capability/satellite navigation with colour monitor i see page 50	<input type="radio"/>	680.85	800.00
Mobile phone system with Bluetooth® (does not include phone or cradle) ³ – see page 60 for details of mobile phone compatibility i see page 50	<input type="radio"/>	255.32	300.00

○ = Optional at extra cost

1 = Please note: a separate electrical adaptor (13-pin to 7-pin) is required – available as an accessory at extra cost. This adaptor does not allow for supplementary trailer power requirements. **2** = Must be used with separate base carrier (available as a Vauxhall accessory) if luggage is to be carried on the roof. **3** = Deletes drinks holders in centre console.



4-door saloon

Option availability

VXR8 Price (£) Total (£)
exc. VAT inc. VAT

Exterior option

Two-coat metallic paint	N/C	No-cost option
-------------------------	-----	----------------

N/C = No-cost option.

Model	Price (£)	VAT (£)	Total (£)	On-the-road RRP (£)	CO ₂ * (g/km)
VXR8					
6.0i V8 (417PS)	29069.79	5087.21	34157.00	35105.00	365
6.0i V8 (417PS) auto	30261.28	5295.72	35557.00	36505.00	339

Please note: On-the-road recommended retail prices (RRP) include number plates and delivery to retailer of £598.00 (inc. £89.06 VAT), 12 months' Vehicle Excise Duty (see page 3) and new vehicle first registration fee of £50.00. Excludes fuel and insurance.

* = CO₂ emission figure. Vehicle Excise Duty is based on CO₂ emissions (see page 3 for details). For benefit in kind taxation charges see page 3.

Astra Sport Hatch	Price (£)	VAT (£)	Total (£)	On-the-road RRP (£)	CO ₂ * (g/km)
Astra SXi					
1.6i 16v	12010.21	2101.79	14112.00	14900.00	158

Astra	Price (£)	VAT (£)	Total (£)	On-the-road RRP (£)	CO ₂ * (g/km)
Astra Club 5-door hatchback					
1.6i 16v	11584.68	2027.32	13612.00	14400.00	158
Astra Active 5-door hatchback (Special Edition model)					
1.4i 16v	11159.15	1952.85	13112.00	13900.00	151
1.6i 16v	11584.68	2027.32	13612.00	14400.00	158
Astra Energy 5-door hatchback (Special Edition model)					
1.6i 16v	11584.68	2027.32	13612.00	14400.00	158
Astra SXi 5-door hatchback					
1.6i 16v	12010.21	2101.79	14112.00	14900.00	158

Astra TwinTop	Price (£)	VAT (£)	Total (£)	On-the-road RRP (£)	CO ₂ * (g/km)
Astra TwinTop					
1.6i 16v	13814.47	2417.53	16232.00	17045.00	168
Astra TwinTop Sport					
1.6i 16v	14495.32	2536.68	17032.00	17845.00	168

Vectra	Price (£)	VAT (£)	Total (£)	On-the-road RRP (£)	CO ₂ * (g/km)
Vectra Exclusiv 5-door hatchback					
1.8i 16v VVT	11942.13	2089.87	14032.00	14845.00	173
<i>Diesel</i>					
1.9CDTi (120PS)	12793.19	2238.81	15032.00	15820.00	154
1.9CDTi 16v (150PS)	13218.72	2313.28	15532.00	16320.00	154
Vectra SRi 5-door hatchback					
<i>Diesel</i>					
1.9CDTi 16v (150PS)	15622.98	2734.02	18357.00	19145.00	154

Please note: On-the-road recommended retail prices (RRP) include number plates and delivery to retailer of £598.00 (inc. £89.06 VAT), 12 months' Vehicle Excise Duty (see page 3) and new vehicle first registration fee of £50.00. Excludes fuel and insurance.

* = CO₂ emission figures. Vehicle Excise Duty is based on CO₂ emission (see page 3 for details). For benefit in kind taxation charges see page 3.



SWB Combi

Model	Price (£)	VAT (£)	Total (£)	On-the-road RRP (£)	CO ₂ * (g/km)
New Vivaro SWB 9-seat combi					
2900 2.0CDTI 16v (90PS)	16435.00	2876.13	19311.13	20164.13	214



LWB Combi

Model	Price (£)	VAT (£)	Total (£)	On-the-road RRP (£)	CO ₂ * (g/km)
New Vivaro LWB 9-seat combi					
2900 2.0CDTI 16v (115PS)	17850.00	3123.75	20973.75	21826.75	224

Please note: On-the-road recommended retail prices (RRP) include number plates and delivery to retailer of £598.00 (inc. £89.06 VAT), 12 months' Vehicle Excise Duty (£205.00) and new vehicle first registration fee of £50.00. Excludes fuel and insurance.

* = CO₂ emission figures. Vehicle Excise Duty is based on CO₂ emissions (see page 3 for details). For benefit in kind taxation charges see page 3.

Option availability

New Vivaro 9-seat Combi

Option pack		Price (£) exc. VAT	Total (£) inc. VAT
Vision Pack • Rain-sensitive windscreen wipers • Front fog lights • Selective door locking key	<input type="radio"/>	125.00	146.87
Safety and security options			
Front passengers' twin airbag	<input type="radio"/>	235.00	276.12
Electronic Stability Programme-plus (ESP-plus) 1 see page 53	<input type="radio"/>	400.00	470.00
Remote control ultrasonic security alarm system	<input type="radio"/>	125.00	146.87
Interior and seating options			
Driver's seat with lumbar adjustment and armrest	<input type="radio"/>	50.00	58.75
Driver's seat and single front passenger's seat with lumbar adjustment and armrest	<input type="radio"/>	100.00	117.50
Air conditioning – cab area only	<input type="radio"/>	600.00	705.00
Solar Reflect® windscreen	<input type="radio"/>	50.00	58.75
Additional rear heating 1	<input type="radio"/>	200.00	235.00
Front and rear air conditioning	<input type="radio"/>	1200.00	1410.00
Mechanical option			
Speed limiter	<input type="radio"/>	75.00	88.12
Rear door option			
Glazed twin rear doors with heated windows and wash/wipe facility	<input type="radio"/>	150.00	176.25
Exterior options			
16-inch alloy wheels (steel spare)	<input type="radio"/>	350.00	411.25
Two-coat metallic or pearlescent paint	<input type="radio"/>	345.00	405.37
Special paint (restrictions apply – please consult your retailer for availability)	<input type="radio"/>	390.00	458.25
Rear parking distance sensors	<input type="radio"/>	250.00	293.75
Audio and communication options			
CD 70 stereo radio/CD player with MP3 capability/satellite navigation with colour monitor/steering wheel mounted audio controls	<input type="radio"/>	850.00	998.75
Steering wheel mounted audio controls	<input type="radio"/>	50.00	58.75
Factory-fit telephone pre-wiring	<input type="radio"/>	75.00	88.12
Hands-free mobile phone installation kit (retailer-fit) 2	<input type="radio"/>	206.80	243.00

O = Optional at extra cost.
1 = Only available in conjunction with front and rear air conditioning on LWB models **2** = Only available at participating retailers and in conjunction with factory-fit telephone pre-wiring option – see page 60 for details.

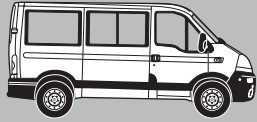

Combi

Model	Price (£)	VAT (£)	Total (£)	On-the-road RRP (£)	CO ₂ * (g/km)
Movano SWB 6-seat semi-glazed combi					
2800 2.5CDTI 16v (100PS)	17895.00	3131.63	21026.63	21974.63	230
Movano SWB 9-seat fully glazed combi					
2800 2.5CDTI 16v (100PS)	18395.00	3219.13	21614.13	22562.13	230
2800 2.5CDTI 16v (146PS)	20795.00	3639.13	24434.13	25382.13	235

Please note: On-the-road recommended retail prices (RRP) include number plates and delivery to retailer of £598.00 (inc. £89.06 VAT), 12 months' Vehicle Excise Duty (£300.00) and new vehicle first registration fee of £50.00. Excludes fuel and insurance.

* = CO₂ emission figures. Vehicle Excise Duty is based on CO₂ emissions (see page 3 for details). For benefit in kind taxation charges see page 3.

Option availability

Movano 6-/9-seat Combi

Option packs

	Price (£) exc. VAT	Total (£) inc. VAT
Electric Pack • Electrically operated front windows • Electrically adjustable/heated door mirrors	275.00	323.12
Technical Pack • Cruise control with driver controllable speed limiter • Trip computer	500.00	587.50

Safety and security options

Front passengers' twin airbag	○ ¹	250.00	293.75
Remote control ultrasonic security alarm system	○	75.00	88.12
Electronic Stability Programme-plus (ESP-plus)	○	750.00	881.25

Interior and seating options

Single front passenger's seat	N/C ¹	No-cost option	
Single fully adjustable 'comfort' front passenger's seat with armrest	○	50.00	58.75
Multi-function front passenger's bench seat with underseat storage facility	○	100.00	117.50
Delete spare wheel (includes tyre repair kit)	N/C	No-cost option	
Trip computer	○	300.00	352.50
Tilting glass sunroof for load area	○	200.00	235.00

Mechanical options

Digital tachograph ²	○	500.00	587.50
Six-pin connection in battery compartment	○	50.00	58.75
Speed limiter	○	75.00	88.12
Height-adjustable pneumatic rear suspension (not available with ESP-plus)	○	1500.00	1762.50
Tow bar	○ ³	350.00	411.25

Exterior options

Rain-sensitive windscreen wipers and Automatic Lighting Control (ALC)	○	250.00	293.75
Two-coat metallic or pearlescent paint	○	345.00	405.37
Special paint (restrictions apply - please consult your retailer for availability)	○	390.00	458.25
Rear parking distance sensors	○	250.00	293.75

Audio and communication options

Stereo radio/cassette player with traffic programme	N/C	No-cost option	
Stereo radio/CD player/satellite navigation with monochromatic display	○	750.00	881.25

○ = Optional at extra cost. N/C = No-cost option.

¹ = Front passengers' twin airbag not available with single front passenger's seat options. ² = Option price for digital tachograph does not include calibration which must be carried out at an approved tachograph centre within 14 days of the vehicles registration. **Please note:** The legislation regarding the use of tachographs is complex and operators should seek independent advice or speak to the Commercial Vehicle specialist at your Vauxhall retailer to ensure compliance. Alternatively your local DVLA office will also be able to provide clarification of the relevant legislation. ³ = Not available with rear parking distance sensors.

	Trans- mission	Fuel economy mpg (litres/100km)		
		Urban driving	Extra-urban driving	Combined figure

Agila

1.0i 12v	manual	40.4 (7.0)	55.4 (5.1)	48.7 (5.8)
1.2i 16v	manual	37.2 (7.6)	55.4 (5.1)	47.1 (6.0)

Tigra

1.4i 16v	manual	34.9 (8.1)	56.5 (5.0)	46.3 (6.1)
1.4i 16v	Easytronic	35.3 (8.0)	57.6 (4.9)	47.1 (6.0)
1.8i 16v	manual	25.9 (10.9)	48.7 (5.8)	36.7 (7.7)
1.3CDTi 16v	manual	48.7 (5.8)	72.4 (3.9)	61.4 (4.6)

New Corsa

1.0i 12v	manual	38.7 (7.3)	61.4 (4.6)	50.4 (5.6)
1.2i 16v exc. SXi	manual	36.7 (7.7)	60.1 (4.7)	48.7 (5.8)
1.2i 16v SXi	manual	35.3 (8.0)	56.5 (5.0)	46.3 (6.1)
1.2i 16v exc. SXi	Easytronic	37.2 (7.6)	61.4 (4.6)	49.6 (5.7)
1.4i 16v	manual	34.9 (8.1)	55.4 (5.1)	45.6 (6.2)
1.4i 16v 3-dr hatch	automatic	32.5 (8.7)	49.6 (5.7)	41.5 (6.8)
1.4i 16v 5-dr hatch	automatic	32.1 (8.8)	48.7 (5.8)	40.9 (6.9)
1.3CDTi 16v (75PS)	manual	49.6 (5.7)	74.3 (3.8)	62.8 (4.5)
1.3CDTi 16v (90PS)	manual	47.9 (5.9)	74.3 (3.8)	61.4 (4.6)
1.7CDTi 16v 3-dr hatch	manual	45.6 (6.2)	70.6 (4.0)	58.9 (4.8)
1.7CDTi 16v 5-dr hatch	manual	44.8 (6.3)	68.9 (4.1)	57.6 (4.9)

	Trans- mission	Fuel economy mpg (litres/100km)		
		Urban driving	Extra-urban driving	Combined figure

Meriva

1.4i 16v	manual	34.0 (8.3)	53.3 (5.3)	44.1 (6.4)
1.6i 16v	manual	32.1 (8.8)	51.4 (5.5)	42.2 (6.7)
1.6i 16v	Easytronic	31.7 (8.9)	52.3 (5.4)	42.2 (6.7)
1.8i 16v	manual	25.9 (10.9)	46.3 (6.1)	35.8 (7.9)
1.8i 16v	Easytronic	26.4 (10.7)	46.3 (6.1)	36.2 (7.8)
1.3CDTi 16v	manual	45.6 (6.2)	65.7 (4.3)	56.5 (5.0)
1.7CDTi 16v	manual	42.8 (6.6)	64.2 (4.4)	54.3 (5.2)

Astra Sport Hatch

1.4i 16v	manual	35.3 (8.0)	56.5 (5.0)	46.3 (6.1)
1.6i 16v VVT ¹	manual	32.5 (8.7)	54.3 (5.2)	43.5 (6.5)
1.6i 16v VVT ²	manual	31.7 (8.9)	52.3 (5.4)	42.2 (6.7)
1.6i 16v VVT	Easytronic	33.2 (8.5)	56.5 (5.0)	44.8 (6.3)
1.8i 16v VVT ¹	manual	28.5 (9.9)	48.7 (5.8)	38.7 (7.3)
1.8i 16v VVT ²	manual	28.0 (10.1)	47.1 (6.0)	37.7 (7.5)
1.8i 16v VVT ¹	automatic	27.2 (10.4)	46.3 (6.1)	36.7 (7.7)
1.8i 16v VVT ²	automatic	26.6 (10.6)	44.8 (6.3)	35.8 (7.9)
1.6i 16v Turbo	manual	27.4 (10.3)	45.6 (6.2)	36.7 (7.7)
1.7CDTi 16v (100PS) ¹	manual	44.1 (6.4)	67.3 (4.2)	56.5 (5.0)
1.7CDTi 16v (100PS) ²	manual	43.5 (6.5)	65.7 (4.3)	55.4 (5.1)
1.9CDTi (120PS)	manual	38.2 (7.4)	57.6 (4.9)	48.7 (5.8)
1.9CDTi (120PS)	automatic	29.4 (9.6)	53.3 (5.3)	40.9 (6.9)
1.9CDTi 16v (150PS)	manual	38.2 (7.4)	57.6 (4.9)	48.7 (5.8)

	Trans- mission	Fuel economy mpg (litres/100km)		
		Urban driving	Extra-urban driving	Combined figure
Astra				
1.4i 16v	manual	35.3 (8.0)	56.5 (5.0)	46.3 (6.1)
1.6i 16v VVT ¹	manual	32.5 (8.7)	54.3 (5.2)	43.5 (6.5)
1.6i 16v VVT ²	manual	31.7 (8.9)	52.3 (5.4)	42.2 (6.7)
1.6i 16v VVT	Easytronic	33.2 (8.5)	56.5 (5.0)	44.8 (6.3)
1.8i 16v VVT ¹	manual	28.5 (9.9)	48.7 (5.8)	38.7 (7.3)
1.8i 16v VVT ²	manual	28.0 (10.1)	47.1 (6.0)	37.7 (7.5)
1.8i 16v VVT ¹	automatic	26.9 (10.5)	45.6 (6.2)	36.2 (7.8)
1.8i 16v VVT ²	automatic	26.4 (10.7)	44.1 (6.4)	35.3 (8.0)
1.6i 16v Turbo	manual	27.4 (10.3)	45.6 (6.2)	36.7 (7.7)
1.3CDTi 16v (90PS)	manual	45.6 (6.2)	70.6 (4.0)	58.9 (4.8)
1.7CDTi 16v (100PS) Life	manual	44.1 (6.4)	67.3 (4.2)	56.5 (5.0)
1.7CDTi 16v (100PS) (exc. Life)	manual	43.5 (6.5)	65.7 (4.3)	55.4 (5.1)
1.9CDTi (120PS)	manual	38.2 (7.4)	57.6 (4.9)	48.7 (5.8)
1.9CDTi (120PS)	automatic	29.1 (9.7)	52.3 (5.4)	40.4 (7.0)
1.9CDTi 16v (150PS)	manual	38.2 (7.4)	57.6 (4.9)	48.7 (5.8)

Astra estate

1.4i 16v	manual	35.3 (8.0)	56.5 (5.0)	46.3 (6.1)
1.6i 16v VVT ¹	manual	32.1 (8.8)	53.3 (5.3)	42.8 (6.6)
1.6i 16v VVT ²	manual	31.4 (9.0)	51.4 (5.5)	41.5 (6.8)
1.6i 16v VVT	Easytronic	32.8 (8.6)	55.4 (5.1)	44.1 (6.4)
1.8i 16v VVT ¹	manual	28.2 (10.0)	47.9 (5.9)	38.2 (7.4)
1.8i 16v VVT ²	manual	27.7 (10.2)	46.3 (6.1)	37.2 (7.6)
1.8i 16v VVT ¹	automatic	26.9 (10.5)	45.6 (6.2)	36.2 (7.8)
1.8i 16v VVT ²	automatic	26.4 (10.7)	44.1 (6.4)	35.3 (8.0)
1.6i 16v Turbo	manual	27.4 (10.3)	45.6 (6.2)	36.7 (7.7)
1.3CDTi 16v (90PS)	manual	45.6 (6.2)	70.6 (4.0)	58.9 (4.8)
1.7CDTi 16v (100PS) Life	manual	44.1 (6.4)	67.3 (4.2)	56.5 (5.0)
1.7CDTi 16v (100PS) (exc. Life)	manual	43.5 (6.5)	65.7 (4.3)	55.4 (5.1)
1.9CDTi (120PS)	manual	37.7 (7.5)	56.5 (5.0)	47.9 (5.9)
1.9CDTi (120PS)	automatic	29.1 (9.7)	52.3 (5.4)	40.4 (7.0)
1.9CDTi 16v (150PS)	manual	37.7 (7.5)	56.5 (5.0)	47.9 (5.9)

	Trans- mission	Fuel economy mpg (litres/100km)		
		Urban driving	Extra-urban driving	Combined figure
Astra TwinTop				
1.6i 16v VVT	manual	31.0 (9.1)	50.4 (5.6)	40.9 (6.9)
1.8i 16v VVT	manual	27.4 (10.3)	45.6 (6.2)	36.7 (7.7)
1.8i 16v VVT	automatic	26.2 (10.8)	43.5 (6.5)	34.9 (8.1)
2.0i 16v Turbo (200PS)	manual	21.2 (13.3)	38.7 (7.3)	29.7 (9.5)
1.9CDTi 16v (150PS)	manual	37.2 (7.6)	55.4 (5.1)	47.1 (6.0)

Zafira

1.6i 16v	manual	29.7 (9.5)	47.1 (6.0)	38.7 (7.3)
1.8i 16v VVT	manual	27.4 (10.3)	44.1 (6.4)	36.2 (7.8)
1.8i 16v VVT	Easytronic	28.0 (10.1)	45.6 (6.2)	37.2 (7.6)
2.2i 16v Direct	manual	25.0 (11.3)	44.1 (6.4)	34.4 (8.2)
2.2i 16v Direct	automatic	24.4 (11.6)	42.2 (6.7)	33.2 (8.5)
2.0i 16v Turbo	manual	21.2 (13.3)	38.7 (7.3)	29.7 (9.5)
1.9CDTi (120PS)	manual	37.2 (7.6)	55.4 (5.1)	47.1 (6.0)
1.9CDTi (120PS)	automatic	28.8 (9.8)	49.6 (5.7)	39.2 (7.2)
1.9CDTi 16v (150PS)	manual	36.7 (7.7)	54.3 (5.2)	46.3 (6.1)
1.9CDTi 16v (150PS)	automatic	28.8 (9.8)	49.6 (5.7)	39.2 (7.2)

The fuel consumption figures shown comply with EC directive 1999/100 to provide a realistic indication of fuel consumption by taking into account everyday driving conditions, such as cold starts, acceleration and braking. These figures take account of the vehicle's kerbweight, ascertained in accordance with the above regulation. **Important:** the results given relate to the particular car tested. Variations in trim level and equipment may result in slightly higher fuel consumption and CO₂ emission levels than those quoted. Driving style, road and traffic conditions, vehicle mileage and standard of maintenance may also affect fuel consumption; therefore the results do not express or imply any guarantee of fuel consumption attainable.

1 = Figures apply to vehicles fitted with wheels up to 16 inches in diameter.

2 = Figures apply to vehicles fitted with 17-inch or 18-inch wheels.

	Trans- mission	Fuel economy mpg (litres/100km)		
		Urban driving	Extra-urban driving	Combined figure
Vectra hatchback/saloon				
1.8i 16v VVT ³	manual	28.0 (10.1)	51.4 (5.5)	39.2 (7.2)
1.8i 16v VVT ⁴	manual	27.7 (10.2)	50.4 (5.6)	38.7 (7.3)
2.2i 16v Direct ³	manual	27.4 (10.3)	47.9 (5.9)	37.7 (7.5)
2.2i 16v Direct ⁴	manual	27.2 (10.4)	47.1 (6.0)	37.2 (7.6)
2.2i 16v Direct ³	automatic	25.0 (11.3)	46.3 (6.1)	35.3 (8.0)
2.2i 16v Direct ⁴	automatic	24.8 (11.4)	45.6 (6.2)	34.9 (8.1)
2.0i 16v Turbo hatch ³	manual	22.6 (12.5)	44.8 (6.3)	32.8 (8.6)
2.0i 16v Turbo hatch ⁴	manual	22.4 (12.6)	44.1 (6.4)	32.5 (8.7)
2.8i V6 24v Turbo hatch	automatic	16.5 (17.1)	38.7 (7.3)	25.9 (10.9)
1.9CDTi (120PS) ³	manual	38.2 (7.4)	60.1 (4.7)	49.6 (5.7)
1.9CDTi (120PS) ⁴	manual	37.7 (7.5)	58.9 (4.8)	48.7 (5.8)
1.9CDTi 16v (150PS) ³	manual	38.2 (7.4)	60.1 (4.7)	49.6 (5.7)
1.9CDTi 16v (150PS) ⁴	manual	37.7 (7.5)	58.9 (4.8)	48.7 (5.8)
1.9CDTi 16v (150PS) hatch ³	automatic	29.7 (9.5)	52.3 (5.4)	40.9 (6.9)
1.9CDTi 16v (150PS) saloon ³	automatic	30.1 (9.4)	53.3 (5.3)	41.5 (6.8)
1.9CDTi 16v (150PS) hatch ⁴	automatic	29.4 (9.6)	51.4 (5.5)	40.4 (7.0)
1.9CDTi 16v (150PS) saloon ⁴	automatic	29.7 (9.5)	52.3 (5.4)	40.9 (6.9)
3.0CDTi V6 24v hatch	manual	28.8 (9.8)	54.3 (5.2)	40.9 (6.9)
3.0CDTi V6 24v hatch	automatic	27.7 (10.2)	53.3 (5.3)	39.8 (7.1)

	Trans- mission	Fuel economy mpg (litres/100km)		
		Urban driving	Extra-urban driving	Combined figure
Vectra estate				
1.8i 16v VVT ³	manual	27.4 (10.3)	47.9 (5.9)	37.7 (7.5)
1.8i 16v VVT ⁴	manual	27.2 (10.4)	47.1 (6.0)	37.2 (7.6)
2.2i 16v Direct ³	manual	26.6 (10.6)	45.6 (6.2)	36.2 (7.8)
2.2i 16v Direct ⁴	manual	26.4 (10.7)	44.8 (6.3)	35.8 (7.9)
2.2i 16v Direct ³	automatic	24.6 (11.5)	44.8 (6.3)	34.4 (8.2)
2.2i 16v Direct ⁴	automatic	24.4 (11.6)	44.1 (6.4)	34.0 (8.3)
2.0i 16v Turbo ³	manual	22.2 (12.7)	43.5 (6.5)	32.1 (8.8)
2.0i 16v Turbo ⁴	manual	22.1 (12.8)	42.8 (6.6)	31.7 (8.9)
2.8i V6 24v Turbo	automatic	16.2 (17.4)	37.2 (7.6)	25.2 (11.2)
1.9CDTi (120PS) ³	manual	37.7 (7.5)	58.9 (4.8)	48.7 (5.8)
1.9CDTi (120PS) ⁴	manual	37.2 (7.6)	57.6 (4.9)	47.9 (5.9)
1.9CDTi 16v (150PS) ³	manual	37.7 (7.5)	58.9 (4.8)	48.7 (5.8)
1.9CDTi 16v (150PS) ⁴	manual	37.2 (7.6)	57.6 (4.9)	47.9 (5.9)
1.9CDTi 16v (150PS) ³	automatic	29.4 (9.6)	51.4 (5.5)	40.4 (7.0)
1.9CDTi 16v (150PS) ⁴	automatic	29.1 (9.7)	50.4 (5.6)	39.8 (7.1)
3.0CDTi V6 24v	manual	28.8 (9.8)	54.3 (5.2)	40.9 (6.9)
3.0CDTi V6 24v	automatic	27.4 (10.3)	52.3 (5.4)	39.2 (7.2)

	Trans- mission	Fuel economy mpg (litres/100km)		
		Urban driving	Extra-urban driving	Combined figure

Signum hatchback

1.8i 16v VVT	manual	27.4 (10.3)	47.9 (5.9)	37.7 (7.5)
2.2i 16v Direct ³	manual	25.9 (10.9)	43.5 (6.5)	34.9 (8.1)
2.2i 16v Direct ⁴	manual	25.7 (11.0)	42.8 (6.6)	34.4 (8.2)
2.2i 16v Direct ³	automatic	24.4 (11.6)	44.1 (6.4)	34.0 (8.3)
2.2i 16v Direct ⁴	automatic	24.1 (11.7)	43.5 (6.5)	33.6 (8.4)
2.0i 16v Turbo ³	manual	22.1 (12.8)	42.8 (6.6)	31.7 (8.9)
2.0i 16v Turbo ⁴	manual	21.9 (12.9)	42.2 (6.7)	31.4 (9.0)
2.8i V6 24v Turbo ³	manual	18.0 (15.7)	37.2 (7.6)	26.6 (10.6)
2.8i V6 24v Turbo ⁴	manual	17.9 (15.8)	36.7 (7.7)	26.4 (10.7)
2.8i V6 24v Turbo	automatic	16.2 (17.4)	37.2 (7.6)	25.2 (11.2)
1.9CDTi (120PS) ³	manual	37.2 (7.6)	57.6 (4.9)	47.9 (5.9)
1.9CDTi (120PS) ⁴	manual	36.7 (7.7)	56.5 (5.0)	47.1 (6.0)
1.9CDTi 16v (150PS) ³	manual	37.2 (7.6)	57.6 (4.9)	47.9 (5.9)
1.9CDTi 16v (150PS) ⁴	manual	36.7 (7.7)	56.5 (5.0)	47.1 (6.0)
1.9CDTi 16v (150PS) ³	automatic	29.4 (9.6)	51.4 (5.5)	40.4 (7.0)
1.9CDTi 16v (150PS) ⁴	automatic	29.1 (9.7)	50.4 (5.6)	39.8 (7.1)
3.0CDTi V6 24v	manual	28.5 (9.9)	53.3 (5.3)	40.4 (7.0)
3.0CDTi V6 24v	automatic	27.4 (10.3)	52.3 (5.4)	39.2 (7.2)

Antara

2.4i 16v	manual	21.2 (13.3)	38.7 (7.3)	29.4 (9.6)
2.0CDTi 16v	manual	32.5 (8.7)	41.5 (6.8)	37.2 (7.6)
2.0CDTi 16v	automatic	25.9 (10.9)	38.7 (7.3)	32.8 (8.6)

New Vivaro 9-seat combi

2.0CDTi 16v (90PS)	manual	28.8 (9.8)	40.4 (7.0)	35.8 (7.9)
2.0CDTi 16v (115PS)	manual	27.7 (10.2)	38.2 (7.4)	33.6 (8.4)

Movano 6-/9-seat SWB combi

2.5CDTi 16v (100PS)	manual	26.6 (10.6)	36.7 (7.7)	32.5 (8.7)
2.5CDTi 16v (146PS)	manual	25.9 (10.9)	36.7 (7.7)	31.7 (8.9)

VXR

	Trans- mission	Fuel economy mpg (litres/100km)		
		Urban driving	Extra-urban driving	Combined figure
Corsa 1.6i 16v Turbo (192PS)	manual	26.9 (10.5)	44.1 (6.4)	35.8 (7.9)
Meriva 1.6i 16v Turbo (180PS)	manual	27.2 (10.4)	44.8 (6.3)	36.2 (7.8)
Zafira 2.0i 16v Turbo (240PS)	manual	21.1 (13.4)	38.2 (7.4)	29.4 (9.6)
Astra 2.0i 16v Turbo (240PS)	manual	21.7 (13.0)	40.4 (7.0)	30.7 (9.2)
Vectra hatchback 2.8i V6 24v Turbo (280PS)	manual	18.2 (15.5)	38.2 (7.4)	27.2 (10.4)
Vectra estate 2.8i V6 24v Turbo (280PS)	manual	18.1 (15.6)	37.7 (7.5)	26.9 (10.5)
VXR8 6.0i V8 (417PS)	manual	12.4 (22.8)	25.9 (10.9)	18.5 (15.3)
VXR8 6.0i V8 (417PS)	automatic	13.7 (20.6)	26.6 (10.6)	19.9 (14.2)

The fuel consumption figures shown comply with EC directive 1999/100 to provide a realistic indication of fuel consumption by taking into account everyday driving conditions, such as cold starts, acceleration and braking. These figures take account of the vehicle's kerbweight, ascertained in accordance with the above regulation. **Important:** the results given relate to the particular car tested. Variations in trim level and equipment may result in slightly higher fuel consumption and CO₂ emission levels than those quoted. Driving style, road and traffic conditions, vehicle mileage and standard of maintenance may also affect fuel consumption; therefore the results do not express or imply any guarantee of fuel consumption attainable.

³ = Figures apply to vehicles fitted with wheels up to 18 inches in diameter.

⁴ = Figures apply to vehicles fitted with 19-inch wheels.

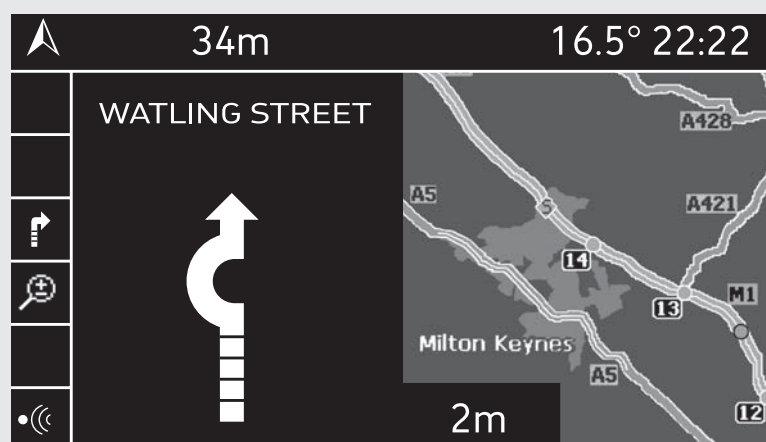

Satellite navigation

Vauxhall's satellite navigation systems are designed for ease of use and extremely high levels of information. Some systems are fitted with the latest Traffic Message Channel (TMC), broadcasting real-time traffic information, delivered either visually or verbally – alerting the driver to a problem on the planned route and then offering an alternative route to avoid the incident.

The systems use the international network of GPS (Global Positioning System) satellites linked to a comprehensive CD-ROM mapping system to determine your precise location and guide you to your chosen destination virtually anywhere in mainland Britain. Additional discs can be purchased for all major European countries, which means that making a cross-European trip can now be as simple as changing a CD.

All units are simple to operate, using a range of menu-driven options which are easily accessed from the central control button or via the steering wheel mounted audio controls. The audible direction guidance prompts give details of road numbers and motorway junction numbers. There are a number of options that enable you to plan your journey – for example by avoiding motorways.

The CD 60 units feature verbal instructions together with schematic arrows displayed in the centrally mounted monochromatic graphic information display. CD 70 units additionally feature a colour monitor (shown above) on most models with a mapping function in addition to the directional arrows.

Mobile phone system with Bluetooth®

Vauxhall's factory-fit dual-band mobile phone system provides integration with the audio and communication system. It also features voice control and will connect wirelessly to phones with Bluetooth® technology.

All the required information is shown on the fascia display when a mobile phone is in use, while the menus are easily navigated by either the steering wheel audio controls or the multi-function button on the radio. Certain functions can also be controlled by voice activation.

The phone system base unit must be fitted with a cradle (available as an accessory) mounted on the centre console – see page 60 for a list of compatible mobile phones.



Please note:

Not all of these features are available on all models. Please see model pages for details.



Rear seat Twin Audio®

Vauxhall's Twin Audio® system provides peace and quiet on long journeys! The system comes with a single headphone set and separate rear controls so front and rear passengers can listen to the radio or a CD totally independently of each other. The rear seat control module sits at the end of the centre console between the two front seats. This provides an on/off switch, independent volume controls for each headset, switching between CD and radio tuner and a scan function.

The system even mutes the rear speakers when any headphones are in use. Additional headphone sets for a second rear seat passenger are available as accessories – contact your Vauxhall retailer for information.



Roof-mounted removable DVD player (retailer-fit)

The DVD player features a seven-inch screen with excellent picture quality and brightness – very important features for in-car use. Mounted in the roof of the vehicle, it's ideally situated to allow good visibility for all rear seat passengers.

It is also removable from the vehicle, offering the advantages of extra security and the ability to continue watching films after the journey has ended – it can even be connected up to a TV if required. Included within the DVD player package are two sets of wireless headphones with carry cases, a remote control and a mains adaptor.

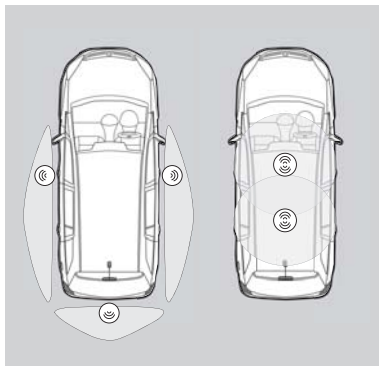

Keyless entry and start

Keyless entry and start system means that the driver need never remove their key fob from their pocket. When approaching the car, sensors in the front door handles and rear bumper detect the driver's proximity and automatically unlock the doors or boot when the handle is pulled.

When in the car, two internal sensors activate the ignition and release the electronic steering lock, enabling the driver to start or stop the engine merely by pressing the facia-mounted Start/Stop button.

Upon leaving the vehicle, the driver can lock it by either pressing a button on the key fob like a conventional system, or by simply touching one of the sensors on the external handles of the front doors.

The system also offers excellent theft protection by its use of sophisticated cryptographic algorithms.



Easytronic transmission

Choose any model with Easytronic transmission and you'll get a five speed manual gearbox with a fully automatic mode. In manual mode, you simply push the lever forward or back to shift gears up or down. The facia display tells you what gear you're in – 1 to 5, N for Neutral or A

for Auto. Switch to fully automatic mode and it has many of the features of a regular automatic including a kickdown function. There's no clutch pedal so you can drive it on an automatic-only driving licence.

Automatic transmissions

A range of four, five and six-speed automatic transmissions are matched to the model and engine size. Many use an electronically controlled adaptive driving programme to tailor gearchanges to suit driving conditions and your driving style. And to reduce the chance of wheelspin in icy conditions, the Winter mode selects a higher than normal gear for standing starts. On five and six-speed transmissions the Active Select manual mode allows the gearlever to be used like a manual gearbox in order to change gear exactly when you want – you simply push the lever forward or back to change up or down the gears.

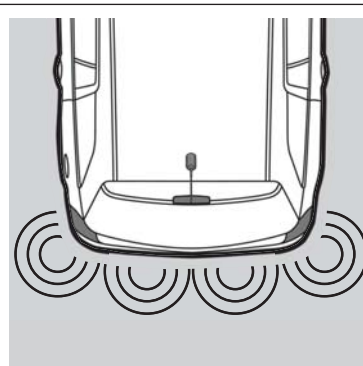

Parking distance sensors

This system helps safeguard your car and pedestrians by providing an audible warning to the driver when an object is detected by one of the sensors. Rear parking distance sensors are operated when reverse gear is selected. Zafira, Vectra and Signum models also feature front parking distance sensors. Additionally there are a range of accessory rear sensors available for fitment by your retailer.

Air conditioning

Air conditioning provides chilled air on hot days and a lot more besides. By dehumidifying the atmosphere inside the car, air conditioning can also increase your comfort and safety with faster window demisting on wet days and an altogether fresher travelling environment the whole year round.



Electronic Climate Control (ECC)

Electronic Climate Control (ECC) offers significant benefits over regular air conditioning by allowing you to set your preferred interior temperature and maintain it, regardless of external temperature and vehicle speed. Switch the system to automatic and it will achieve the desired temperature as swiftly as possible.

A sunlight sensor even accounts for rapid changes in temperature caused by driving in and out of direct sunlight. On Vectra and Signum the system also allows you to choose different cabin temperatures on each side of the car.



Electronic Climate Control (ECC) display as featured on Vectra.

Adaptive Forward Lighting (AFL)

Adaptive Forward Lighting is a sophisticated lighting system that allows you to see around corners by adjusting the headlights to follow the direction of the front wheels. And on some models the 'Cornering light' illuminates kerbs, street signs and tight bends. In fact, *Autocar* magazine were so impressed that they described it as a 'must-have' feature.

New Corsa and Meriva models feature AFL with halogen headlights, whilst Astra, Zafira, Vectra and Signum models with AFL additionally feature more powerful xenon headlights with dynamic beam-levelling, high pressure washers and the 'Motorway light' function.

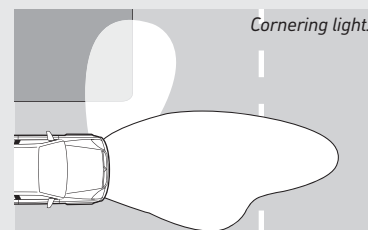

The 'Cornering light' uses an additional bulb and reflector to project a beam of light approximately 90° to the direction of travel when required – for example when turning at junctions or even negotiating tight roundabouts.

The 'Curving light' function is speed-dependent and is activated by movements of the steering wheel and allows the headlight beam to move up to 15 degrees left or right of the straight ahead position. This ensures that the headlight beams are always aimed in the direction you're about to go – and not necessarily the direction the front of the car is already pointing in!

At speeds above 65mph, AFL's 'Motorway light' function raises the dipped headlight beam to extend the range of vision for increased safety at higher speed. The beam automatically returns to its normal position when the car falls below that speed.

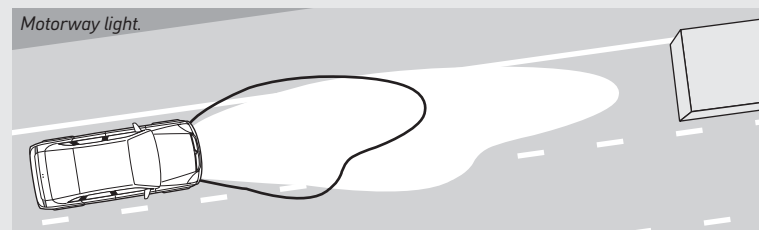
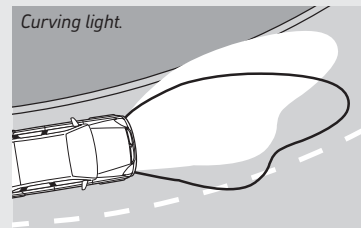

Please note:

Not all of these features are available on all models. Please see model pages for details.

Electronic Stability Programme (ESP)

Electronic Stability Programme has been developed to help the driver maintain control in adverse or emergency situations. ESP compares the direction of the front and rear of the vehicle compared to the driver's steering wheel input. If either the front or rear of the vehicle begins to slide, ESP gently applies corrective braking to the appropriate individual road wheel, controlling and minimising the slide. ESP is utilised in conjunction with Traction Control to

promote safer driving under all road conditions. The latest generation of the system, ESP-plus is an advanced development which features an enhanced yaw compensation system for reducing understeer. This means that ESP-plus has the ability to apply corrective braking to all four road wheels if necessary; a clear advantage over the standard ESP system where only one wheel is retarded in any given situation.

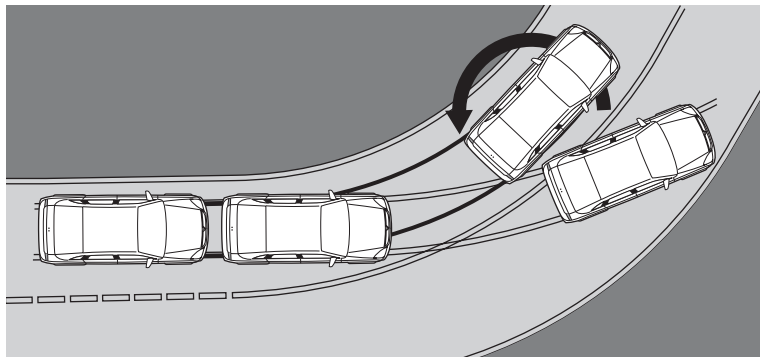

Hill Start Assist (HSA)

As its name suggests, Hill Start Assist helps prevent the vehicle from rolling down gradients of more than five percent immediately after the brake pedal has been released. Brake pressure is maintained for 1.5 seconds after the driver releases the pedal, the brakes are released as soon as the driver presses the accelerator and the car moves forward.

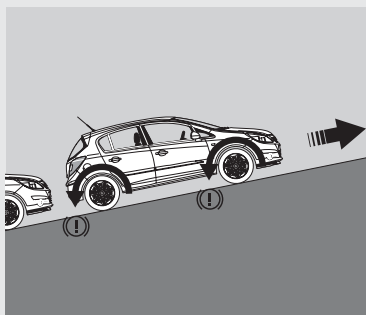

Interactive Driving System-plus (IDS-plus) with Continuous Damping Control (CDC)

The Interactive Driving System (IDS-plus) provides an even sportier driving experience thanks to electronic damping control together with sharper throttle and steering responses. Pressing the 'Sport' switch activates the CDC function which constantly adjusts the rate of damping on

each wheel – effectively stiffening the suspension when required. This means that the vehicle will exhibit a reduced rate of roll and pitch, making it more responsive during direction changes and more settled during the braking/turn-in/acceleration transition when cornering.

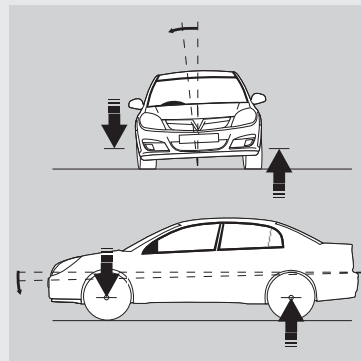

The Sport switch additionally provides a sharper engine response and crisper acceleration, while the power assisted steering is also adjusted, giving the driver a more positive initial turn-in to corners.

Vectra VXR models feature an updated system – IDS²-plus.



Vauxhall accessories are comprehensively researched and tested to ensure the same high quality as the vehicle for which they are intended, making them the right choice for your Vauxhall. Not all accessories are listed, for further details please contact your Vauxhall retailer and ask for a copy of the Car Accessories brochure or Lo-call 0845 600 1500.



Alternatively, you can find all the details on our website www.vauxhall-accessories.com

VXR exterior styling



New Corsa model illustrated features VXR styling front lower spoiler, rear lower skirt and roof spoiler, side sills and optional factory-fitted 17-inch alloy wheels.

	Total (inc.VAT)
VXR New Corsa styling (painted and fitted*)	
Front lower spoiler	£262.80
Side sills (pair)	£533.42
Rear lower spoiler	£268.08
Rear roof spoiler	£288.50

VXR Tigra styling (painted and fitted*)	
Front lower spoiler	£319.79
Side sills (pair)	£540.61
Rear lower spoiler	£288.08
Rear lip spoiler	£308.43

	Total (inc.VAT)
VXR Astra styling (painted and fitted*)	
Front lower spoiler	
- Sport Hatch	£266.79
- hatchback	£359.55
'V' grille logo trim - matt silver-effect	£39.59
Door mirror covers	
- chrome-effect	£54.52
- matt silver-effect	£38.54
Door handle covers (set of four)	
- matt silver-effect	£118.59
Side sills (pair)	
- Sport Hatch	£481.49
- hatchback	£492.91
- estate	£518.12

Vauxhall retailers regularly feature special offers from our Accessory range.

Speak to your local retailer for more details.



Tigra side sills: £540.61



Tigra front lower spoiler: £319.79

VXR exterior styling

	Total (inc.VAT)
VXR Astra styling (painted and fitted*)	
continued	
Rear lower skirt	
- Sport Hatch	£270.33
- hatchback	£310.08
- estate	£315.37
Rear roof spoiler including aerial adaptor¹	
- Sport Hatch	£286.51
- hatchback	£280.50
- estate	£286.61
Tailgate handle – matt silver-effect	
- hatchback	£67.15
- estate	£75.15

1 = Not suitable for SRi models.

VXR Zafira styling (painted and fitted*)	
Front lower spoiler	£266.79
'V'-grille logo trim – matt silver-effect	£79.57
Side sills (pair)	£567.45
Door mirror covers (pair)	
- matt silver-effect	£38.56
Door handle covers (set of four)	
- matt silver-effect	£118.59
Rear lower skirt	£272.08
Rear roof spoiler	£286.51
Tailgate handle – matt silver-effect	£89.14

VXR Vectra styling (painted and fitted*)	
Front lower spoiler	£266.79
Side sills (pair)	£473.45
Rear lower skirt²	
- hatchback/saloon	£272.08
- estate	£277.37
Rear spoiler	
- hatchback/saloon	£286.51
- estate	£300.61

2 = Only suitable for SRi models. Not available with optional parking distance sensors on estate models.

Irmscher exterior styling



Model illustrated features Irmscher front lower spoiler, side sills, cross hatch grille – black with aluminium upper and laser-etched 'Irmscher' logo, rear hood spoiler and 17-inch Sport Star alloy wheels.



New Corsa rear hood spoiler: £392.00

Please note:

* Prices shown are a special fully fitted price at participating retailers only. Please check with your local Vauxhall retailer for details. All other prices exclude fitting.

It is advisable to ensure your insurance policy is adequate to cover additional fitted accessories.

Prices correct at time of going to press.

	Total (inc.VAT)
Irmscher Agila styling (painted and fitted*)	
Rear roof spoiler	£303.00
Irmscher Tigra styling (painted and fitted*)	
Front lower skirt extensions	£411.00
Cross hatch grille	
- black with 'Irmscher' badge	£160.00
- Cross hatch grille with aluminium upper and laser-etched 'Irmscher' badge	£182.00
Door handle covers – stainless steel (pair)	£56.00
Rear wing spoiler	£426.00
Carbon-effect panel for rear bumper (pair)	£84.00

Irmscher New Corsa styling (painted and fitted*)	
Front lower spoiler	£411.00
Cross hatch grille with 'Irmscher' badge – black	£176.00
Cross hatch grille with aluminium upper and laser-etched 'Irmscher' badge	£203.00
Door handle cover – stainless steel	
- 3-door	£56.00
- 5-door	£92.00
Door handle spoilers (pair)	£147.00
Side sills (pair)	£554.00
Rear hood spoiler	£392.00

Irmscher Meriva styling (painted and fitted*)	
Front lower spoiler	£441.00
Cross hatch grille with 'Irmscher' or 'i' logo badge – black	£139.00
Cross hatch grille with aluminium upper and laser-etched 'Irmscher' badge	£170.00
Side sills (pair)	£574.00
Side pillar trim kit – carbon-effect	£166.00
Rear lower skirt	£433.00
Rear roof spoiler	£321.00

Irmischer exterior styling



	Total (inc.VAT)
Irmischer Astra styling (painted and fitted*)	
Front lower spoiler – hatchback/estate	£365.00
Front air dam with fog lights ³	£826.00
Front lower skirt extensions	
– Sport Hatch	£453.00
Cross hatch grille with 'Irmischer' badge	
– black (exc. Sport Hatch)	£164.00
Cross hatch grille with 'Irmischer' badge	
– hatchback/estate	£220.00
– Sport Hatch	£276.00
Cross hatch grille with aluminium upper and laser-etched 'Irmischer' badge	
– hatchback/estate	£276.00
– Sport Hatch	£326.00
Headlight eyebrows	£126.00
Side sills (pair)	£553.00
Door handle covers – stainless steel	
– Sport Hatch (pair)	£56.00
– hatchback/estate (set of four)	£92.00
Fuel flap cover – aluminium-effect	£34.00
Tail lights (pair) – white – Sport Hatch	£197.00
Rear bumper sports insert	
– hatchback	£344.00
– Sport Hatch	£286.00
Rear roof spoiler	£356.00
Rear wing spoiler – Sport Hatch	£398.00

Model illustrated features Irmischer front lower skirt extensions, side sills, aluminium-effect fuel flap cover, sports silencer with dual branched split oval design chrome-plated tailpipes, rear bumper sports insert, 'Irmischer' badge, rear roof spoiler and 19-inch GT Star alloy wheels.

	Total (inc.VAT)
Irmischer Astra TwinTop styling (painted and fitted*)	
Front air dam with fog lights ³	£826.00
Front lower skirt extensions	£453.00
Cross hatch grille with 'Irmischer' badge	£276.00
Cross hatch grille with aluminium upper and laser-etched 'Irmischer' badge	£326.00
Headlight eyebrows	£126.00
Side sills (pair)	£553.00
Door handle covers – stainless steel (pair)	£56.00
Fuel flap cover – aluminium-effect	£34.00
Rear wing spoiler	£370.00

³ = Must be used in conjunction with Astra hatchback cross hatch grille on Sport Hatch/TwinTop models.

	Total (inc.VAT)
Irmischer Zafira styling (painted and fitted*)	
Front lower spoiler	£453.00
Cross hatch grille	
– black with 'Irmischer' logo badge	£145.00
– black with aluminium upper and laser-etched 'Irmischer' badge	£201.00
Side sills (pair)	£553.00
Door handle covers – stainless steel (set of four)	£92.00
Fuel flap cover – aluminium-effect	£34.00
Rear roof spoiler	£369.00

	Total (inc.VAT)
Irmischer Vectra/Signum styling (painted and fitted*)	
Front lower spoiler	£444.00
Cross hatch grille	
– black with 'Irmischer' badge	£206.00
– black with aluminium upper and laser-etched 'Irmischer' badge	£237.00
Side sills (pair) – hatchback/saloon	£518.00
Side sills (pair) – estate/Signum	£539.00
Door mirror covers (pair) – chrome-effect	£151.00

Door handle covers	
– stainless steel (set of four)	£92.00
Side pillar trim kit – carbon-effect	£230.00
Rear bumper sports inserts (for use with sports silencer) – SRI only	£456.00
– except SRI	from £456.00
Rear lower skirt (for use with sports silencer) – hatchback/saloon	£424.00
Rear wing spoiler – DTM-style	
– hatchback/saloon	£438.00
Rear roof spoiler	
– hatchback	£342.00
– estate	£348.00
– Signum	£369.00

Irmischer Antara styling (painted and fitted*)	
Door handle covers	
– stainless steel (set of four)	£92.00
Door handle spoilers (pair)	£147.00
Side steps (pair)	£529.00
Rear roof spoiler	£385.00



	Total (inc.VAT)
Irmischer sports silencer (fitted*)	
Sports silencer with split oval design chrome-plated tailpipes	
– Tigra	£301.00
– Astra hatch/Sport Hatch/estate	£369.00
– Zafira	£359.00
Sports silencer with twin round stainless steel tailpipes – Tigra	£301.00
Sports silencer with twin rectangular stainless steel tailpipes	
– Meriva	£446.00
– Vectra	£440.00
– Signum ⁴	£440.00
Sports silencer with dual branched split oval design chrome-plated tailpipes⁴	
– Astra hatch/Sport Hatch	£497.00
Sports silencer with dual branched twin rectangular stainless steel tailpipes⁴	
– Vectra/Signum	£807.00

⁴ = Must be used in conjunction with Irmischer rear bumper sports insert (Astra) or rear lower skirt (Vectra/Signum).



Velour floor mats from: £56.00

Please note:

Irmischer offer a wide range of suspension kits to lower and uprate your vehicle. Please see our website www.vauxhall-accessories.com for details or contact your retailer.

Interior styling

	Agila	New Corsa	Meriva	Tigra	Astra	Astra TwinTop	Zafira	Vectra/Signum	Antara	Price inc. VAT*
VXR										
Stainless steel pedals (manual)				○	○		○			from £83.42
Gear lever gaiter – black leather				○						£59.57
Handbrake gaiter – black leather				○						£59.57
Handbrake and gear lever gaiters – black leather				○						£114.86
Interior door sill covers – pair (not fitted)					○					£23.98
Irmscher										
'Irmscher' tax disc holder – anodised aluminium with twist-off back	○	○	○	○	○	○	○	○	○	£22.00
Aluminium pedals (manual)		○	○	○	○	○	○	○		£118.00
Velour floor mats with heel protector and 'Irmscher' logo (set of four)		○	○		○	○	○	○	○	£65.00
Velour floor mats with heel protector and 'Irmscher' logo – pair				○						£56.00
Three-spoke steering wheels – black leather	○									£342.00
Three-spoke steering wheels – black leather ⁵			○	○						£336.00
Three-spoke steering wheels – black leather (320mm diameter) ⁶			○	○						£425.00
Three-spoke steering wheels – black leather (340mm diameter) ⁶			○	○						£592.00
Three-spoke steering wheels – two tone (various effects)	○				○	○	○	○		£498.00
Three-spoke steering wheels – two tone (various effects) ⁵			○	○						£441.00
Gear knob – black leather	○									£71.00
Gear knobs (manual) – various effects			○	○						£88.00
Gear lever/handbrake gaiter – black leather				○						£116.00
Gear lever/handbrake gaiters (manual) – light or dark grey leather			○							£132.00
Handbrake levers – various effects			○	○	○	○	○			£88.00
Foldable front centre armrest		○			○ ⁷	○ ⁷	○			£119.00
Door lock buttons (pair) – aluminium			○					○		£36.00
Door lock buttons (pair) – chrome-plated			○					○		£39.00
Interior door handle covers (pair) – matt chrome-effect				○	○	○	○			£47.00
Stainless steel-effect interior door sill covers – set of four	○									£109.00
Stainless steel interior door sill covers – pair								○		£148.00
Stainless steel interior door sill covers – pair			○							£140.00
Stainless steel interior door sill covers – set of four			○							£233.00
Stainless steel interior door sill covers – pair					○	○				£144.00

5 = Steering wheels are available with and without remote audio controls. 6 = Requires additional adaptor £54.00. 7 = Suitable for vehicles fitted with optional Smoker pack only. Not suitable for vehicles fitted with Twin Audio® system.



Please note:

* Prices shown are a special fully fitted price at participating retailers only. Please check with your local Vauxhall retailer for details. All other prices exclude fitting.

It is advisable to ensure your insurance policy is adequate to cover additional fitted accessories.

Prices correct at time of going to press.



Tax disc holder: £22.00



Irmscher alloy wheels (set of four)

	New Corsa	Meriva	Tigra	Astra	Astra Twin Top	Zafira	Vectra/Signum	Antara	Price inc. VAT ⁸
Softstar									
6J x 14	○								£559.00
6J x 15		○							£617.00
7J x 15				○ ⁹	○ ⁹	○			£719.00
6J x 16		○							£682.00
7J x 16		○	○	○	○	○	○		£755.00
7½J x 17			○	○	○	○	○		£997.00
Twin Spoke									
6J x 15		○	○						£430.00
7J x 15				○ ⁹	○ ⁹				£452.00
7J x 16		○	○						£543.00
7½J x 17			○	○		○			£658.00
Spectra Line									
6J x 14	○								£391.00
6J x 15		○							£430.00
7J x 16			○						£543.00
Spectra Sports Line									
7½J x 17				○	○		○		£1265.00
'Centrelock' cover				○	○		○		£62.00
Gamma									
6J x 14	○								£559.00
6J x 15		○							£617.00
Sport Star									
6½J x 16				○	○	○	○		£863.00
7J x 17	○	○ ¹⁰	○						£1093.00
7½J x 17	○			○	○	○	○		£1093.00
8J x 18				○	○	○	○		£1514.00

	New Corsa	Meriva	Tigra	Astra	Astra Twin Top	Zafira	Vectra/Signum	Antara	Price inc. VAT ⁸
Signa									
6½J x 16		○	○	○	○	○	○		£683.00
8J x 18				○	○	○	○		£1332.00
Delta									
7J x 17		○	○ ¹⁰	○	○	○	○		£997.00
8J x 19				○	○	○	○		£1625.00
Stila									
6½J x 15	○	○	○	○	○	○	○		£683.00
6½J x 16	○	○	○	○	○	○	○		£683.00
8J x 18				○	○	○	○		£1332.00
Stila - polished									
8J x 18				○	○	○	○		£1332.00
Evo Star									
7½J x 18 ¹¹				○	○	○	○		£1332.00
8½J x 20							○ ¹⁰	○	£1707.00
GT Star									
8J x 19 ¹¹				○	○	○	○		£1610.00
Wheel accessories (set of four)									
Locking bolts	○	○	○	○	○	○	○	○	£33.00
Locking bolt covers	○	○	○	○	○	○	○	○	£4.00
Aluminium valve caps	○	○	○	○	○	○	○	○	£17.00
Vauxhall centre covers (each)	○	○	○	○	○	○	○		£3.00
Irmscher centre covers	○	○	○	○	○	○	○	○	£20.00

⁸ = Fully fitted price excluding tyres includes static wheel balancing. Please note fitting larger diameter wheels than standard will require the fitment of new tyres at extra cost. ⁹ = Suitable for 1.7 diesel and 1.8 petrol engines only. ¹⁰ = Certain wheel/tyre combinations may also require modification to the wheel arches. ¹¹ = Also available in titanium finish at no extra cost.

Safety

	Total (inc.VAT)
Warning triangle – all models	£13.98
First aid kit – all models	£9.00
Temporary tyre repair kit, includes sealant and compressor	£89.88
Rear parking distance sensor – number plate mounted (fitted*)	
– Agila/Tigra/New Corsa/Meriva/Astra hatchback/Sport Hatch	£169.99
Rear parking distance sensor – bumper mounted (fitted*)	
– Astra hatchback	£368.19
– Astra estate	£377.19
– Zafira	£426.18
– Vectra hatch/saloon/Signum	£347.04
– Vectra estate	£400.04



Floor mat sets from: £17.98

Please note:

* Prices shown are a special fully fitted price at participating retailers only. Please check with your local Vauxhall retailer for details. All other prices exclude fitting.

It is advisable to ensure your insurance policy is adequate to cover additional fitted accessories.

Prices correct at time of going to press.

Security

	Total (inc.VAT)
Locking wheel bolts (set of four)	
– all models except Agila/VXR8	£24.99
Locking wheel nuts (set of four) – Agila	£26.03
Steering wheel security bar	
– all models	£53.99
Thatcham approved alarm system (fitted*)	
– Astra/Zafira (petrol)	£303.73
– Agila/Meriva/Tigra (petrol)	£311.37
– Meriva/Tigra (diesel)	£337.81
– New Corsa (petrol)/Astra/Zafira (diesel)	£330.17
– New Corsa (diesel)	£356.61

Practical

Towing rod (up to 2500kg)	
– all models except Tigra/VXR8	£47.00
Hi-visibility vest	£5.01
Spare bulb kit ¹²	
– all models except VXR8	£15.63
Fuel cans – 5-litre – all models	£12.98
Stretch tow rope (2 tonne rated)	
– all models	£19.86
Jump leads – 16mm standard	
– all models	£28.02
Fire extinguisher – all models – 1kg	£21.97

Protection

Rubber floor mats (front pair)	
– Meriva/Tigra/Astra/Vectra/Signum	£19.98
– New Corsa/Astra TwinTop/Zafira	£20.00
Rubber floor mats (rear pair)	
– Meriva/Astra/Vectra/Signum	£13.98
– New Corsa/Astra Twin Top	£13.99
Rubber floor mats (set of four)	
– Agila	£34.02
– Zafira (second/third row)	£20.00

Protection – continued

	Total (inc.VAT)
Economy floor mats (set of four)	
– Agila	£17.98
– Tigra	£17.98
– New Corsa	£17.98
– Meriva	£17.98
– Astra hatch/Sport Hatch/estate	£16.98
– Zafira	£18.00
– Vectra/Signum	£16.98
Velour floor mats (set of four)	
– Agila/Tigra	£40.01
– Corsa	£39.01
– New Corsa	£39.66
– Meriva	£40.01
– Astra hatch/Sport Hatch/estate	£39.01
– Zafira	£40.00
– Vectra	£39.01
– Signum	£40.01
Deluxe velour floor mats (set of four)	
– Meriva/Astra/Astra TwinTop/Zafira (set of six)/Vectra/Signum	£49.00
Contoured velour floor mats (set of four)	
– Meriva/Astra/Vectra/Signum	£52.99
Dog guard (fitted*)	
– Astra estate ¹³ /Vectra estate ¹³	£99.87
– Zafira ¹³	£128.07
Space divider grid (for use with dog guard)	
– Astra estate/Vectra estate	£82.00
– Zafira	£109.00
Load-restraining floor net	
– Agila	£37.00
– Astra estate/Zafira	£25.00
– Vectra/Signum	£13.98
– Vectra estate	£26.03
Bootliner – flexible liner with storage bag	
– Tigra	£64.04
– Meriva/Astra	£65.21
– Vectra	£62.86
Cargo liner – rigid moulded plastic liner	
– Agila/New Corsa/Meriva/Astra/Sport Hatch/Zafira/Vectra/Signum	£48.00

	Total (inc.VAT)
Headlight protectors – standard	
– Agila/New Corsa/Tigra/Astra/Zafira/Vectra/Signum	£37.01
– Meriva (includes continental touring convertor decals)	£37.01
Headlight protectors – continental touring	
– Agila	£37.01
Headlight protectors – carbon fibre-effect	
– New Corsa/Meriva/Tigra/Astra/Zafira	£37.01
Mudflaps (front pair – fitted*) ¹⁴	
– Agila	£39.12
Mudflaps (set of four – fitted*) ¹⁴	
– all models except Agila/Tigra/New Corsa/Astra TwinTop/Zafira SRi/VXR8	£72.96
– New Corsa	£78.24
Door wind deflectors (front pair)	
– Meriva/Astra (hatch/estate)/Vectra/Signum	£39.00
– Astra Sport Hatch	£32.00
Windbreak	
– Astra TwinTop	£193.88
Supagard paint and fabric protection	
Exterior/fabric packs	
– Base pack	£199.00
– UltraPro Silver	£299.00
– UltraPro Gold	£399.00
Exterior/leather packs	
– Base pack	£210.00
– UltraPro Silver	£299.00
– UltraPro Gold	£399.00

¹² = Not for vehicles with xenon headlights or Adaptive Forward Lighting.

¹³ = Requires additional fitting kit at £76.88 (fitted*) for Astra estate, £99.87 (fitted*) for Zafira, £99.87 (fitted*) for Vectra estate, if vehicle is not equipped with the factory-fit vertical load restraining net option or dog guard fixing points.

¹⁴ = Not available on some models when fitted with exterior styling accessories.

Load carriers

	Total (inc.VAT)
Roof carrier system¹⁵ – all models except Tigra/Astra TwinTop/VXR8	
Base carrier (for use without roof rails) – all models	from £95.76
Low profile base carrier (for use with roof rails) – Agila/Zafira/Vectra estate/Signum	£95.76
Premium bicycle carrier – all models except Agila ¹⁶	£67.00
Side loading bicycle carrier¹⁶ – New Corsa/Astra/Vectra/Signum	£146.01
– Meriva/Zafira	£176.00
Alloy ski/snowboard carrier¹⁶	£54.00
Sport roof box (450 litres)¹⁶	£237.00
Surfboard/windsurf board carrier – all models except Agila ¹⁶	from £41.99

¹⁵ = Roof carrier systems vary dependent on model. Please consult your retailer for details.

¹⁶ = Must be used in conjunction with a base carrier.

Tow bar carrier system – all models except Agila/VXR8	
Bicycle carrier – tow bar mounted two bicycle carrier with rear lights (excludes number plate)	£247.92
Additional bicycle carrier (for use with two bicycle carrier) – all models except New Corsa	£66.00



Sport roof box: £237.00

Mobile phones/DVD

	Total (inc.VAT)
Hands-free mobile phone installation kit (fitted*) – only available with factory-fit telephone pre-wiring option. Suitable for many specific mobile phones, ask your retailer for details – New Vivaro	£243.00
Hands-free Bluetooth® mobile phone cradle – only available with factory-fit option on New Corsa/Astra/Zafira/Vectra/Signum. Suitable for the following mobile phones: – Motorola V400 – Nokia E50/E60/3100/6100/6020/6021/6220/6230/6233/6234/6310(i)/6610/6820/7210/7250(i) – Siemens C65/CX65/M55/M65/S55/S65/C55/CX70/SP65 – Sony-Ericsson K610i/K700i/K750i/T610/T630/W310i/W510i/W800i/W810i	£96.93
Roof-mounted removable DVD player (fitted*)¹⁷ – Meriva/Astra estate/Zafira/Vectra estate	£742.87

¹⁷ = Not suitable if vehicle is fitted with sunroofs or panoramic roof.

Interior

Smoker pack includes cigar lighter and ashtray – all models except Monaro – please consult your retailer for pricing and availability details.	
Cigar lighter illumination kit – Agila	£22.00

Essential accessory packs

	Total (inc.VAT)
Travel pack – First aid kit/Warning triangle/Spare bulb kit/Fire extinguisher 1kg/High-visibility vest – all models except VXR8	£49.00
Protection pack – Velour mats (four)/Mudflaps (four)/Cargo liner – all models except Agila/ Tigra/ Astra TwinTop/VXR8	£149.00
Protection pack – Velour mats (four)/Mudflaps (two)/Cargo liner – Agila	£119.00
Protection pack – Velour mats (four)/Mudflaps (four)/Windbreak – Tigra	£179.00
Protection pack – Deluxe velour mats (four)/Mudflaps (four)/Windbreak – Astra TwinTop	£199.00
Protection plus pack – Paint and trim protection/Velour mats (four)/Mudflaps (four) – all models except Agila/Tigra/ Astra TwinTop/VXR8	£279.00
Protection plus pack – Paint and trim protection/Velour mats (four)/Mudflaps (two) – Agila	£249.00
Protection plus pack – Paint and trim protection/Velour mats (four) – Tigra	£229.00
Protection plus pack – Paint and trim protection/Deluxe velour mats (four) – Astra TwinTop	£229.00



Removable DVD player: £742.87



Base carriers from: £95.76



Mudflaps from: £39.12 (pair)

Child seats¹⁸ – all models except VXR8

	Total (inc.VAT)
Vauxhall child seats – all models except Monaro	
Vauxhall BABY-SAFE (0-13kg/birth to 15 months)	£95.55
Vauxhall DUO ISOFIX (9-18kg/9 months to 4 years)	£191.10
Vauxhall KID (15-36kg/4 to 12 years)	£85.05
Vauxhall baby mirror – all models except Agila and VXR8	£12.00

¹⁸ = Restrictions apply to the use of child seats, please consult your Vauxhall retailer.



Child seats from: **£85.05**

Please note:

* Prices shown are a special fully fitted price at participating retailers only. Please check with your local Vauxhall retailer for details. All other prices exclude fitting.

It is advisable to ensure your insurance policy is adequate to cover additional fitted accessories.

Prices correct at time of going to press.

Towing

	Total (inc.VAT)
Agila	
Fixed tow bar (fitted*)	
– 12N electrics	£366.41
– 12N/12S electrics	£455.06
New Corsa	
Detachable tow bar (fitted*)	
– 12N electrics	£438.04
Meriva	
Detachable tow bar (fitted*)	
– 12N electrics	£426.04
– 12N/12S electrics	£510.47
– 13-pin electrics	£434.46
Towing mirrors (pair)	£84.00



Tow bars from: **£236.59**

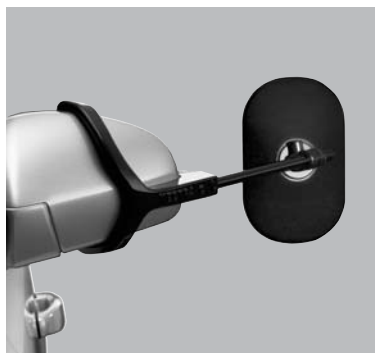

Towing mirrors from: **£84.00 (pair)**

	Total (inc.VAT)
Astra¹⁹	
Fixed tow bar (fitted*)	
– 12N electrics	£236.59
– 12N/12S electrics	£317.32
– 13-pin electrics	£276.46
Detachable tow bar (Sport Hatch/hatch) (fitted*)	
– 12N electrics	£389.59
– 12N/12S electrics	£470.31
– 13-pin electrics	£429.46
Detachable tow bar (estate) (fitted*)	
– 12N electrics	£442.59
– 12N/12S electrics	£523.32
– 13-pin electrics	£482.46
Astra TwinTop	
Detachable tow bar (fitted*)	
– 12N electrics	£415.59
– 12N/12S electrics	£496.32
– 13-pin electrics	£455.46
Towing mirrors (pair)	£84.00

	Total (inc.VAT)
Zafira	
Fixed tow bar (fitted*)	
– 12N electrics	£326.60
– 12N/12S electrics	£407.32
– 13-pin electrics	£366.47
Detachable tow bar (fitted*)	
– 12N electrics	£448.60
– 12N/12S electrics	£529.32
– 13-pin electrics	£488.47
Vectra/Signum	
Fixed tow bar (hatch/saloon) (fitted*)	
– 12N electrics	£297.31
– 12N/12S electrics	£375.03
– 13-pin electrics	£341.46
Fixed tow bar (estate/Signum) (fitted*)	
– 12N electrics	£291.30
– 12N/12S electrics	£369.03
– 13-pin electrics	£335.46
Detachable tow bar (hatch/saloon) (fitted*)	
– 12N electrics	£425.58
– 12N/12S electrics	£503.31
– 13-pin electrics	£469.74
Detachable tow bar (estate/Signum) (fitted*)	
– 12N electrics	£469.30
– 12N/12S electrics	£547.63
– 13-pin electrics	£513.46
13-pin to 7-pin adaptor (estate) (for use with factory-fitted retractable tow bar)	
	£49.00
Towing mirrors (pair)	£84.00

¹⁹ = Astra 1.4/1.6 models require additional components at extra cost. Please consult your retailer for further details and prices.

Our commitment to innovation, quality and reliability helps make every Vauxhall both enjoyable to drive and easy to live with. Invest in a new Vauxhall, however, and you'll get far more than a great drive. You also gain access to a range of customer-led products and services that set high standards for customer care and support.

Customer Care Commitment

For added peace of mind, Vauxhall has an innovative Customer Care Commitment* that offers the following:

- A one-year unlimited mileage manufacturer's warranty
- Second and third year no-fee customer option warranty up to 60,000 miles (100,000 miles Vivaro/Movano combi models) from first registration
- Vauxhall Assistance for 12 months from first registration
- Six years body panel anti-perforation warranty

Vauxhall Assistance**

Vauxhall Assistance is provided automatically with every new Vauxhall for 12 months from first registration and covers everything from accident assistance, roadside recovery, 'at home' service and flat tyres to illness while driving. With Vauxhall Assistance help is literally just a free† phone call away, 24 hours a day, 365 days a year!

Vauxhall Rental

A nationwide network guarantees well prepared and maintained Vauxhalls for rental at competitive rates which include insurance and Vauxhall Assistance.

For further information please call **0870 442 1567**.

Vauxhall Leasing

As Vauxhall's own contract hire and fleet management operation, Vauxhall Leasing provides a one-stop-shop for competitive car and van leasing solutions – for business users and private individuals. Working with the Vauxhall retailer network, we combine the support of a national contract with the convenience of a local contact.

For further information, please see your local Vauxhall retailer or call us on **0870 737 2557**. Alternatively, you can visit our website at www.vauxhall-leasing.co.uk

Buying your Vauxhall

For straightforward advice on a simple, affordable way into a new or used car ask your Vauxhall retailer. GMAC offers a wide range of finance solutions that are easy to understand, flexible enough to suit every need and convenient to arrange at your Vauxhall retailer.

Fleet Customer Services

Our dedicated support services for fleet managers includes factory demonstrators, a three-day test drive programme and information on whole life costs, company car taxation and finance.

For further information please call **0870 010 0651**.

Specialist Mobility advice

Motability accredited Vauxhall retailers can provide special mobility help and advice. Blue badge holders are entitled to very favourable discounts when purchasing new vehicles. For full details contact your local Motability accredited Vauxhall retailer or Freephone **0800 731 5267**.

For more product information

For a brochure on any Vauxhall model (up to a maximum of three per caller) or location of your nearest Vauxhall retailer please Lo-call **0845 600 1500**. Alternatively, details can be found on our website at www.vauxhall.co.uk

Lo-call 0845 600 1500
www.vauxhall.co.uk



* Warranty is only on vehicles sourced from Vauxhall Motors Ltd. Terms and conditions apply – please see your Vauxhall retailer for details.

** Conditions may apply to combi/minibus models.

† Mobile phone users will be charged at their standard tariff.

Sureguard protection

Should you wish to enjoy Vauxhall Assistance for a full three years from first registration, then new Sureguard Assistance is for you. If you are a higher mileage driver or plan to keep your vehicle for longer than the standard warranty period, you need the protection of Sureguard Warranty. This provides all the peace of mind of a parts and labour warranty – including Assistance – for the duration of your cover. Both now come with the added peace of mind of Sureguard MOT Warranty. For details contact your Vauxhall retailer or call **0870 752 7020**.

	Sureguard Assistance (inc. MOT Warranty) 36 months††	Sureguard Warranty (includes Assistance and MOT Warranty)
		48 months††/ 60,000 miles††
Agila / Corsa / Meriva	£139.00	£325.00
Astra / TwinTop / Zafira / Tigra	£139.00	£375.00
Vectra / Signum	£139.00	£425.00
Vivaro/Movano	£225.00	£635.00

Prices quoted include VAT or IPT (Sureguard Assistance only) at 17.5% and were correct at time of going to press but are subject to change without prior notice. †† From date of vehicle's first registration. Cover will expire at the end of the cover period/mileage limit whichever is the sooner.

Save with The GM Card



- Save up to £2000* on a new Vauxhall with The GM Card
- 100 Rebate Points worth £100 when you use The GM Card for the first time
- Rebate Point saving is on top of any discount or offer negotiated with the Retailer
- Earn 3 Rebate Points (£3) for every £100 you spend

Typical 14.9% APR variable

To apply call **0845 746 2777**
or visit **www.gmcard.co.uk**

Get extremely good protection from Vauxhall Insurance

Make tracks to Vauxhall and your premium could plunge as much as £75 (Direct Excellence, Sept 06)
Call now or alternatively buy on-line
and you'll save 10%

Call **0870 024 0240**
www.vauxhall.co.uk/insurance

Lines open 8am – 8pm Monday to Friday
9am – 5pm Saturdays

Max call charge from a BT landline is 8p per minute. Calls from other networks may vary. Calls may be recorded. Conditions apply.

The GM Platinum Card is issued by HFC Bank Limited and is available to persons aged 18 years or over and resident in the UK (or 21 and over in the Channel Islands) and is subject to status and conditions. Written quotations are available upon request from The GM Platinum Card, PO Box 3615, Birmingham B3 2RJ. The typical APR quoted is the rate for new customers. *Rebate Points are earned on purchases using The GM Platinum Card. Rebate Points are not earned on Balance Transfers or Cash Advances. You earn money off a new Vauxhall/Saab by accumulating Rebate Points under the Rebate Points Programme. Vauxhall Motors Ltd is solely responsible for the operation of the Rebate Points Programme, which is subject to the Rebate Points Programme Rules. You can redeem up to 2500 Rebate Points subject to the Model Line Maximum which will vary in amount in relation to different Vauxhall/Saab vehicle model lines and unlimited Partner Points. Rebate Points and unlimited Partner Points are redeemable as discounts on a new Vauxhall/Saab vehicle and must be redeemed four years from the issue date. Rebate Points may not be redeemed by Motability Contract Hire customers. The GM Card is a trading name and style of both HFC Bank Limited and Vauxhall Motors Ltd. HFC Bank registered in England No. 1117305. Registered Office: North Street, Winkfield, Windsor, Berkshire SL4 4TD is authorised and regulated by the Financial Services Authority. Member: HSBG Group HFC Bank Limited is not a member of the same group of companies as Vauxhall Motors Ltd, Saab GB Limited or GMAC (UK) plc. Vauxhall Motors Ltd, Registered Office: Griffin House, Osborne Road, Luton, Bedfordshire LU1 3YT. Registered in England number 135767. – CN6/0987.

For a copy of this brochure in large print, Braille or on audio tape, please call 0845 600 1500, or via our textphone service on 18001 08456 785 785.

Every effort has been made to ensure that the contents of this publication were accurate and up-to-date at the time of going to press (April 2007). The invoice price, including delivery to retailer, factory-fitted options, accessories fitted by the retailer and number plates, is subject to VAT. The right is reserved to alter specifications and prices, and withdraw products from sale, without notice. Please note that Vauxhall retailers are not the agents of Vauxhall Motors Limited and are not authorised to bind the Company by any specific or implied undertaking or representation. It is advisable to ensure that your motor insurance policy provides adequate cover for additional fitted options and accessories. As part of Vauxhall's policy of environmental care, this brochure is printed on paper manufactured using Elemental Chlorine Free pulps from specially farmed, sustainable timber resources. All rights reserved. No part of this publication may be reproduced in any form or by any means, without the prior written permission of Vauxhall Motors Limited.

