

CAR RANGE

PRICE GUIDE

12 June 2020 | Model Year 2020/2021

MMY 2020



VAUXHALL

ALL-NEW CORSA

Price and Specification Guide | 5 June 2020 | Model Year 2020.5



VAUXHALL

CONTENTS

Choose your Trim Level

Range Highlights

Models

Prices

Features/Options

Interior Style and Comfort

Infotainment

Exterior Colours

Wheels and Tyres

Engines and Technical Data

Performance, Economy and Emissions

Specifications

Dimensions and Capacities

Accessories

Company Car Information

Further Information

CHOOSE YOUR TRIM LEVEL

SE

First in the line-up is the wonderfully well-equipped SE, with Premium and Nav versions available; SE, SE Premium, SE Nav and SE Nav Premium.

CORSA-E SE NAV

Say hello to the new Corsa-e. It's 100% electric, 100% exciting.



VX_COR_29984.psd

SRI

This sporty number also comes with Premium and Nav versions available; SRi, SRi Premium, SRi Nav and SRi Nav Premium.



VX_COR_29973.psd

Elite Nav

Both Elite Nav models come with sat nav as standard, with Elite Nav Premium giving you even more styling and technology features; Elite Nav, Elite Nav Premium.

CORSA-E ELITE NAV

Say hello to the new Corsa-e. It's 100% electric, 100% exciting.



VX_COR_30107.psd

Ultimate Nav

All you could ask for; our range-topping Ultimate Nav model completes the range.



VX_COR_29991.psd

CORSA RANGE HIGHLIGHTS

SE

Standard features include:

- 7-inch colour touchscreen
- Multimedia infotainment system
- LED headlights with high beam assist
- 16-inch silver 4-twinspoke alloy wheels
- Air conditioning
- Cruise control with intelligent speed limiter
- Trip computer
- Driver's seat height adjuster
- Body-colour front and rear bumpers
- Remote control central locking
- Electrically operated front windows
- Electrically adjustable/heated door mirrors
- Lane departure warning with lane assist
- Speed sign recognition
- Leather-covered flat-bottom steering wheel
- Driver drowsiness system
- Automatic emergency city braking
- Anti-lock Braking System (ABS)
- Six airbags
- 60/40 split-folding rear seat back
- Electric parking brake (auto models only)

SRI

Features over SE models:

- Vauxhall Connect
- 7-inch digital instrument cluster
- Sports front and rear body styling
- Alloy-effect sports pedals
- Sport switch
- Sports-style front seats
- LED tail lights
- LED front fog lights
- Chrome-effect exhaust tailpipe extension
- Electrically operated rear windows
- Black roof and A-pillars
- High gloss black B-pillars and tailgate spoiler
- Dark-tinted rear windows
- Rear parking distance sensors
- 16-inch silver Hurricane 4-twinspoke alloy wheels
- Remote control security alarm system

ELITE NAV

Features over SE models:

- Multimedia Navi infotainment system
- Vauxhall Connect
- 7-inch digital instrument cluster
- Heated front seats
- Heated steering wheel (excluding auto models)
- Rain-sensitive windscreen wipers
- Automatic lighting control
- Automatic anti-dazzle rear-view mirror
- Front passenger's seat height adjuster
- Centre armrest with storage
- Fabric/premium leather-effect seat trim
- Panoramic rear-view camera
- Side blind spot alert and flank guard
- Front and rear parking distance sensors
- Electrically folding door mirrors
- Electrically operated rear windows
- Black roof and A-pillars
- High gloss black B-pillars and tailgate spoiler
- Dark-tinted rear windows
- Chrome-effect lower side window trim
- 16-inch silver 8-spoke alloy wheels
- Remote control security alarm system

ULTIMATE NAV

Features over Elite Nav models:

- Multimedia Navi Pro infotainment system
- 10-inch colour touchscreen
- Electronic climate control
- Perforated leather seat trim inserts
- Driver's seat with electrical adjustment and massage function
- IntelliLux LED[®] Matrix headlights with LED tail lights
- 17-inch diamond-cut gloss black 5-twinspoke alloy wheels
- Adaptive cruise control
- Keyless entry and start
- Electric parking brake
- Lane positioning assistant

CORSA-E RANGE HIGHLIGHTS

SE NAV

Standard features include:

- Multimedia Navi infotainment system
- 7-inch colour touchscreen
- Electronic climate control
- Rain-sensitive windscreen wipers
- Automatic lighting control
- Automatic anti-dazzle rear-view mirror
- Electric parking brake
- Rear parking distance sensors
- Keyless start
- 16-inch bi-colour alloy wheels
- Remote control security alarm system
- LED headlights with high beam assist
- Cruise control with intelligent speed limiter
- Trip computer
- Driver's seat height adjuster
- Body-colour front and rear bumpers
- Remote control central locking
- Electrically operated front and rear windows
- Electrically adjustable/heated door mirrors
- Lane departure warning with lane assist
- Speed sign recognition
- Leather-covered flat-bottom steering wheel
- Driver drowsiness system
- Automatic emergency city braking
- Anti-lock Braking System (ABS)
- Six airbags
- 60/40 split-folding rear seat back
- Vauxhall Connect
- 7-inch digital instrument cluster

ELITE NAV

Features over SE Nav models:

- Multimedia Navi Pro infotainment system
- 10-inch colour touchscreen
- IntelliLux LED® Matrix headlights
- Keyless entry and start
- 17-inch bi-colour alloy wheels
- Heated front seats
- Heated steering wheel
- Front passenger's seat height adjuster
- Centre armrest with storage
- Fabric/premium leather-effect seat trim
- Panoramic rear-view camera
- Front and rear parking distance sensors
- Electrically folding door mirrors
- Black roof and A-pillars
- High gloss black B-pillars and tailgate spoiler
- Side blind spot alert and flank guard
- Dark-tinted rear windows
- Chrome-effect lower side window trim

ALL-NEW CORSA SE



VX_COR_29984.psd

SE OTR from £16,415

Infotainment:

- Multimedia
 - 7-inch colour touchscreen
 - AM/FM/DAB digital radio
 - Bluetooth® audio streaming
 - Bluetooth® mobile phone portal
 - Apple CarPlay™/Android Auto™
 - USB audio connection
- Six speakers

Interior convenience/styling:

- Air conditioning
- Flat-bottomed leather-covered steering wheel
- Cruise control with intelligent speed limiter
- Trip computer
- Speed-sensitive power-assisted steering
- Steering column adjustable for reach/rake
- Steering wheel audio/phone/cruise controls
- Driver's seat height adjuster
- 60/40 split-folding rear seat back
- Electric parking brake (auto models only)

Exterior convenience/styling:

- LED headlights
- High beam assist
- 16-inch silver 4-twin-spoke alloy wheels
- Remote control central locking
- Electrically operated front windows
- Electrically adjustable/heated door mirrors
- Body-colour front and rear bumpers

Safety/security features:

- Lane departure warning with lane assist
- Speed sign recognition
- Automatic emergency city braking
- Hill start assist
- ISOFIX child seat fixings on outer rear seats

SE NAV OTR from £17,155

Features over SE

- Multimedia Navi
 - Satellite navigation system
 - 7-inch colour touchscreen
 - 2D/3D street level mapping
 - European coverage
 - Points-of-interest search
- Vauxhall Connect

SE PREMIUM OTR from £17,195

Features over SE

- Heated front seats
- Heated steering wheel (excluding auto models)
- Rain-sensitive windscreen wipers
- Automatic lighting control
- Automatic anti-dazzle rear-view mirror
- Rear parking distance sensors

SE NAV PREMIUM OTR from £17,935

Features over SE Premium

- Multimedia Navi
 - Satellite navigation system
 - 7-inch colour touchscreen
 - 2D/3D street level mapping
 - European coverage
 - Points-of-interest search
- Vauxhall Connect

This vehicle is covered by our Price Protection Guarantee. See 'Further Information' page for details.

ALL-NEW CORSA SRi



VX_COR_29973.psd



VX_COR_30838.psd

SRi Premium and Nav Premium alloy wheel.

SRi OTR from £19,365

Infotainment:

- Multimedia
 - 7-inch colour touchscreen
 - AM/FM/DAB digital radio
 - Bluetooth® audio streaming
 - Bluetooth® mobile phone portal
 - Apple CarPlay™/Android Auto™
 - USB audio connection
- Six speakers • Vauxhall Connect

Interior convenience/styling:

- Air conditioning
- Flat-bottomed leather-covered steering wheel
- Steering column adjustable for reach/rake
- Steering wheel audio/phone/cruise controls
- Sport switch • Sports-style front seats
- 7-inch digital instrument cluster

Exterior convenience/styling:

- LED head and tail lights
- LED front fog lights • High beam assist
- 16-inch silver Hurricane 4-twinspoke alloy wheels
- Remote control central locking
- Electrically operated front and rear windows
- Electrically adjustable/heated door mirrors
- Chrome-effect exhaust tailpipe extension
- Black roof and A-pillars
- High gloss black B-pillars and tailgate spoiler
- Dark-tinted rear windows
- Rear parking distance sensors

Safety/security features:

- Lane departure warning with lane assist
- Speed sign recognition
- Automatic emergency city braking
- Remote control security alarm system
- ISOFIX child seat fixings on outer rear seats

SRi NAV OTR from £19,865

Features over SRi

- Multimedia Navi
 - Satellite navigation system
 - 7-inch colour touchscreen
 - 2D/3D street level mapping
 - European coverage
 - Points-of-interest search

SRi PREMIUM OTR from £20,830

Features over SRi

- 17-inch black Hurricane 4-twinspoke alloy wheels
- Heated front seats and steering wheel
- Rain-sensitive windscreen wipers
- Automatic lighting control
- Automatic anti-dazzle rear-view mirror
- Electronic climate control
- Electrically folding door mirrors
- Keyless entry and start

SRi NAV PREMIUM OTR from £21,330

Features over SRi Premium

- Multimedia Navi
 - Satellite navigation system
 - 7-inch colour touchscreen
 - 2D/3D street level mapping
 - European coverage
 - Points-of-interest search

This vehicle is covered by our Price Protection Guarantee. See 'Further Information' page for details.

ALL-NEW CORSA ELITE NAV



VX_COR_30107.psd



VX_COR_30189.psd

Elite Nav alloy wheel.

Elite Nav Premium model illustrated.

ELITE NAV OTR from £19,655

Infotainment:

- Multimedia Navi
 - Satellite navigation system
 - 7-inch colour touchscreen
 - 2D/3D street level mapping
 - European coverage
 - Points-of-interest search
 - AM/FM/DAB digital radio
 - Bluetooth® audio streaming
 - Bluetooth® mobile phone portal
 - Apple CarPlay™/Android Auto™
 - USB audio connection
- Six speakers
- Vauxhall Connect

Interior convenience/styling:

- Air conditioning
- Flat-bottomed leather-covered steering wheel
- Heated front seats and steering wheel (excluding auto models)
- Rain-sensitive windscreen wipers
- Automatic lighting control
- Automatic anti-dazzle rear-view mirror
- Driver's and front passenger's seat height adjuster
- Centre armrest with storage
- Fabric/premium leather-effect seat trim
- Electric parking brake (auto models only)
- 7-inch digital instrument cluster

Exterior convenience/styling:

- LED headlights
- High beam assist
- 16-inch silver 8-spoke alloy wheels
- Panoramic rear-view camera
- Front and rear parking distance sensors

- Electrically adjustable/folding/heated door mirrors
- Remote control central locking
- Electrically operated front and rear windows
- LED front fog lights
- Black roof and A-pillars
- High gloss black B-pillars and tailgate spoiler
- Dark-tinted rear windows
- Chrome-effect lower side window trim

Safety/security features:

- Lane departure warning with lane assist
- Traffic sign recognition with intelligent speed adaptation
- Side blind spot alert and flank guard
- Automatic emergency city braking
- Remote control security alarm system
- ISOFIX child seat fixings on outer rear seats

ELITE NAV PREMIUM OTR from £21,015

Features over Elite Nav

- Multimedia Navi Pro
 - Satellite navigation system
 - 10-inch colour touchscreen
 - 2D/3D street level mapping
 - European coverage
 - Points-of-interest search
- Keyless entry and start
- 17-inch diamond-cut gloss black 5-twinspoke alloy wheels
- Electronic climate control

This vehicle is covered by our Price Protection Guarantee. See 'Further Information' page for details.

ALL-NEW CORSA ULTIMATE NAV



VX_COR_29991.psd

ULTIMATE NAV OTR £26,695

Infotainment:

- Multimedia Navi Pro
 - Satellite navigation system
 - 10-inch colour touchscreen
 - 2D/3D street level mapping
 - European coverage
 - Points-of-interest search
 - AM/FM/DAB digital radio
 - Bluetooth® audio streaming
 - Bluetooth® mobile phone portal
 - Apple CarPlay™/Android Auto™
 - USB audio connection
- Six speakers
- Vauxhall Connect

Interior convenience/styling:

- Electronic climate control
- Flat-bottomed leather-covered steering wheel
- Heated front seats
- Rain-sensitive windscreen wipers
- Automatic lighting control
- Automatic anti-dazzle rear-view mirror
- Steering column adjustable for reach/rake
- Steering wheel audio/phone/cruise controls
- Perforated leather seat trim inserts
- Driver's seat with electrical adjustment and massage function
- Driver's and front passenger's seat height adjuster
- Centre armrest with storage
- 60/40 split-folding rear seat back
- Electric parking brake
- 7-inch digital instrument cluster

Exterior convenience/styling:

- IntelliLux LED® Matrix headlights with LED tail lights
- High beam assist
- 17-inch diamond-cut gloss black 5-twinspoke alloy wheels
- Panoramic rear-view camera
- Front and rear parking distance sensors
- Electrically adjustable/folding/heated door mirrors
- Remote control central locking
- Electrically operated front and rear windows
- LED front fog lights
- Black roof and A-pillars
- High gloss black B-pillars and tailgate spoiler
- Dark-tinted rear windows
- Keyless entry and start
- Chrome-effect lower side window trim

Safety/security features:

- Adaptive cruise control
- Automatic emergency braking
- Lane positioning assistant
- Traffic sign recognition with intelligent speed adaptation
- Side blind spot alert and flank guard
- Driver drowsiness system
- LED daytime running lights
- Remote control security alarm system
- ISOFIX child seat fixings on outer rear seats

This vehicle is covered by our Price Protection Guarantee. See 'Further Information' page for details.

ALL-NEW CORSA-E SE NAV



VX_COR_e_29985.psd

SE NAV

OTR from £27,665*

Infotainment:

- Multimedia Navi
 - Satellite navigation system
 - 7-inch colour touchscreen
 - 2D/3D street level mapping
 - European coverage
 - Points-of-interest search
 - AM/FM/DAB digital radio
 - Bluetooth® audio streaming
 - Bluetooth® mobile phone portal
 - Apple CarPlay™/Android Auto™
 - USB audio connection
- Six speakers
- Vauxhall Connect

Interior convenience/styling:

- Electronic climate control
- Flat-bottomed leather-covered steering wheel
- Rain-sensitive windscreen wipers
- Automatic lighting control
- Automatic anti-dazzle rear-view mirror
- Cruise control with speed limiter
- Trip computer
- Speed-sensitive power-assisted steering
- Steering column adjustable for reach/rake
- Steering wheel audio/phone/cruise controls
- Driver's seat height adjuster
- 60/40 split-folding rear seat back
- Electric parking brake
- 7-inch digital instrument cluster

Exterior convenience/styling:

- LED headlights
- High beam assist
- 16-inch bi-colour alloy wheels
- Remote control central locking
- Electrically operated front and rear windows
- Electrically adjustable/heated door mirrors
- Body-colour front and rear bumpers
- Rear parking distance sensors
- Keyless start

Safety/security features:

- Lane departure warning with lane assist
- Speed sign recognition
- Driver drowsiness system
- Hill start assist
- Remote control security alarm system
- Automatic emergency city braking
- ISOFIX child seat fixings on outer rear seats

*Price shown is after allowing for PiCG (Plug-in Car Grant).

ALL-NEW CORSA-E ELITE NAV



VX_COR_e_29912.psd

ELITE NAV OTR from £30,310*

Infotainment:

- Multimedia Navi Pro
 - Satellite navigation system
 - 10-inch colour touchscreen
 - 2D/3D street level mapping
 - European coverage
 - Points-of-interest search
 - AM/FM/DAB digital radio
 - Bluetooth® audio streaming
 - Bluetooth® mobile phone portal
 - Apple CarPlay™/Android Auto™
 - USB audio connection
- Six speakers
- Vauxhall Connect

Interior convenience/styling:

- Electronic climate control
- Flat-bottomed leather-covered steering wheel
- Heated front seats and steering wheel
- Rain-sensitive windscreen wipers
- Automatic lighting control
- Automatic anti-dazzle rear-view mirror
- Driver's and front passenger's seat height adjuster
- Centre armrest with storage
- Fabric/premium leather-effect seat trim
- Electric parking brake
- 7-inch digital instrument cluster

Exterior convenience/styling:

- IntelliLux LED® Matrix headlights
- High beam assist with anti-glare
- 17-inch bi-colour diamond-cut alloy wheels
- Panoramic rear-view camera
- Front and rear parking distance sensors
- Electrically adjustable/folding/heated door mirrors
- Remote control central locking
- Electrically operated front and rear windows
- LED front fog lights
- Black roof and A-pillars
- High gloss black B-pillars and tailgate spoiler
- Dark-tinted rear windows
- Keyless entry and start
- Chrome-effect lower side window trim

Safety/security features:

- Lane departure warning with lane assist
- Traffic sign recognition
- Side blind spot alert and flank guard
- Driver drowsiness system
- Remote control security alarm system
- Automatic emergency city braking
- ISOFIX child seat fixings on outer rear seats

*Price shown is after allowing for PiCG (Plug-in Car Grant).

ALL-NEW CORSA PRICES

	Pack Code	Fuel Type	Price (£)	VAT (£)	Total (£)	On-the-road RRP (£)	Financial Year 2020/21 BiK 20% (£)	WLTP Combined CO ₂ (g/km)* - pack code	Insurance Groups
SE									
1.2 (75PS)	AC48 ED1A	Petrol	12,904.17	2,580.83	15,485.00	16,415.00	75.52	125	10E
1.2 (100PS) Turbo	AC48 EM6A	Petrol	13,570.84	2,714.16	16,285.00	17,215.00	79.25	126	16E
1.2 (100PS) Turbo auto	AC48 EE8A	Petrol	15,012.50	3,002.50	18,015.00	18,985.00	90.45	134	16E
1.5 (102PS) Turbo D	AC48 HQ6A	Diesel	14,579.17	2,915.83	17,495.00	18,405.00	72.77	109	tba
SE NAV									
1.2 (75PS)	AC48 ED1C	Petrol	13,520.84	2,704.16	16,225.00	17,155.00	78.98	125	10E
1.2 (100PS) Turbo	AC48 EM6C	Petrol	14,187.50	2,837.50	17,025.00	17,955.00	82.72	126	16E
1.2 (100PS) Turbo auto	AC48 EE8C	Petrol	15,629.17	3,125.83	18,755.00	19,725.00	94.02	134	16E
1.5 (102PS) Turbo D	AC48 HQ6C	Diesel	15,195.84	3,039.16	18,235.00	19,145.00	75.73	109	tba
SE PREMIUM									
1.2 (75PS)	AC48 ED1E	Petrol	13,554.17	2,710.83	16,265.00	17,195.00	79.17	125	10E
1.2 (100PS) Turbo	AC48 EM6E	Petrol	14,220.84	2,844.16	17,065.00	17,995.00	82.90	126	16E
1.2 (100PS) Turbo auto	AC48 EE8E	Petrol	15,662.50	3,132.50	18,795.00	19,765.00	94.22	134	16E
1.5 (102PS) Turbo D	AC48 HQ6E	Diesel	15,229.17	3,045.83	18,275.00	19,185.00	75.90	109	tba
SE NAV PREMIUM									
1.2 (75PS)	AC48 ED1G	Petrol	14,170.84	2,834.16	17,005.00	17,935.00	82.62	125	10E
1.2 (100PS) Turbo	AC48 EM6G	Petrol	14,837.50	2,967.50	17,805.00	18,735.00	86.35	126	17E
1.2 (100PS) Turbo auto	AC48 EE8G	Petrol	16,279.17	3,255.83	19,535.00	20,505.00	97.80	134	17E
1.5 (102PS) Turbo D	AC48 HQ6G	Diesel	15,845.84	3,169.16	19,015.00	19,925.00	78.85	109	tba

Corsa's petrol and diesel engines meet the Real Driving Emissions Step 2 (RDE2) standards.

WLTP Combined CO₂ (g/km) figures, valid 3 March 2020, are based on a configured vehicle as per pack code for UK with no options fitted.

*Fuel consumption and CO₂ figures are determined according to the WLTP test cycle. CO₂ figures, BiK values and RRP pricing shown above are for a standard vehicle without any additional optional equipment. CO₂ figures are used to calculate Vehicle Excise Duty (VED) for the first registration of the vehicle and BiK. The addition of optional extras could increase the certified CO₂ emission output. This in turn may affect the amount of VED payable upon registration, and, for company car drivers, the P11D value and the amount of Benefit in Kind (BiK) tax payable. Figures shown are for comparison purposes and should only be compared to the fuel consumption and CO₂ values of other cars tested to the same technical standard. The fuel consumption achieved, and CO₂ produced, in real world conditions will depend upon a number of factors including, but not limited to: the accessories fitted (pre and post registration); variations in weather; driving styles and vehicle load. The WLTP (Worldwide Harmonised Light Vehicles Test Procedure) is used to measure fuel consumption and CO₂ figures. Full data relating to WLTP test cycles can be found at: www.vauxhall.co.uk/wltp

Please note: On-the-road recommended retail prices (RRP) include number plates and delivery to Retailer of £700.00 (inc. £116.67 VAT), 12 months' Vehicle Excise Duty and new vehicle first registration fee of £55.00. Excludes fuel and insurance. Company Car Benefit in Kind (BiK) rates are monthly based on the standard paint price.

ALL-NEW CORSA PRICES

	Pack Code	Fuel Type	Price (£)	VAT (£)	Total (£)	On-the-road RRP (£)	Financial Year 2020/21 BiK 20% (£)	WLTP Combined CO ₂ (g/km)* - pack code	Insurance Groups
SRI									
1.2 (100PS) Turbo	AS48 EM6J	Petrol	15,362.50	3,072.50	18,435.00	19,365.00	89.28	125	17E
1.5 (102PS) Turbo D	AS48 HQ6J	Diesel	16,370.83	3,274.17	19,645.00	20,555.00	81.37	108	18E
SRI NAV									
1.2 (100PS) Turbo	AS48 EM6L	Petrol	15,779.17	3,155.83	18,935.00	19,865.00	91.62	125	17E
1.5 (102PS) Turbo D	AS48 HQ6L	Diesel	16,787.50	3,357.50	20,145.00	21,055.00	83.37	108	18E
SRI PREMIUM									
1.2 (100PS) Turbo	AS48 EM6M	Petrol	16,583.34	3,316.66	19,900.00	20,830.00	96.13	126	17E
1.5 (102PS) Turbo D	AS48 HQ6M	Diesel	17,591.67	3,518.33	21,110.00	22,020.00	90.87	110	18E
SRI NAV PREMIUM									
1.2 (100PS) Turbo	AS48 EM6Q	Petrol	17,000.00	3,400.00	20,400.00	21,330.00	98.47	126	17E
1.5 (102PS) Turbo D	AS48 HQ6Q	Diesel	18,008.33	3,601.67	21,610.00	22,520.00	92.95	110	19E
ELITE NAV									
1.2 (100PS) Turbo	AE48 EM6R	Petrol	15,604.17	3,120.83	18,725.00	19,655.00	90.63	125	17E
1.2 (100PS) Turbo auto	AE48 EE8R	Petrol	17,045.83	3,409.17	20,455.00	21,425.00	102.23	133	17E
1.5 (102PS) Turbo D	AE48 HQ6R	Diesel	16,612.50	3,322.50	19,935.00	20,845.00	82.53	108	19E
ELITE NAV PREMIUM									
1.2 (100PS) Turbo	AE48 EM6T	Petrol	16,737.50	3,347.50	20,085.00	21,015.00	96.98	126	17E
1.2 (100PS) Turbo auto	AE48 EE8T	Petrol	18,179.17	3,635.83	21,815.00	22,785.00	108.82	134	17E
1.5 (102PS) Turbo D	AE48 HQ6T	Diesel	17,745.84	3,549.16	21,295.00	22,205.00	87.97	109	19E
ULTIMATE NAV									
1.2 (100PS) Turbo auto	AE48 EE8X	Petrol	21,437.50	4,287.50	25,725.00	26,695.00	127.72	134	17E

Corsa's petrol and diesel engines meet the Real Driving Emissions Step 2 (RDE2) standards.

WLTP Combined CO₂ (g/km) figures, valid 3 March 2020, are based on a configured vehicle as per pack code for UK with no options fitted.

*Fuel consumption and CO₂ figures are determined according to the WLTP test cycle. CO₂ figures, BiK values and RRP pricing shown above are for a standard vehicle without any additional optional equipment. CO₂ figures are used to calculate Vehicle Excise Duty (VED) for the first registration of the vehicle and BiK. The addition of optional extras could increase the certified CO₂ emission output. This in turn may affect the amount of VED payable upon registration, and, for company car drivers, the P11D value and the amount of Benefit in Kind (BiK) tax payable. Figures shown are for comparison purposes and should only be compared to the fuel consumption and CO₂ values of other cars tested to the same technical standard. The fuel consumption achieved, and CO₂ produced, in real world conditions will depend upon a number of factors including, but not limited to: the accessories fitted (pre and post registration); variations in weather; driving styles and vehicle load. The WLTP (Worldwide Harmonised Light Vehicles Test Procedure) is used to measure fuel consumption and CO₂ figures. Full data relating to WLTP test cycles can be found at: www.vauxhall.co.uk/wltp

Please note: On-the-road recommended retail prices (RRP) include number plates and delivery to Retailer of £700.00 (inc. £116.67 VAT), 12 months' Vehicle Excise Duty and new vehicle first registration fee of £55.00. Excludes fuel and insurance. Company Car Benefit in Kind (BiK) rates are monthly based on the standard paint price.

ALL-NEW CORSA-E PRICES

	Pack Code	Price (£)	VAT (£)	Total (£)	On-the-road RRP before PiCG (£)	On-the-road RRP after PiCG (£)	BiK 20% (£)	WLTP Combined CO ₂ (g/km) [#] - pack code	Insurance groups
SE NAV 7.4kW									
Electric Propulsion (136PS)	9AD48 9CQA	24,925.00	4,985.00	29,910.00	30,665.00	27,665.00	Zero [#]	0	24E
SE NAV 11kW*									
Electric Propulsion (136PS)	9AD48 9CQC	25,633.33	5,126.67	30,760.00	31,515.00	28,515.00	Zero [#]	0	24E
ELITE NAV 7.4kW									
Electric Propulsion (136PS)	9AF48 9CQP	27,129.17	5,425.83	32,555.00	33,310.00	30,310.00	Zero [#]	0	25E
ELITE NAV 11kW*									
Electric Propulsion (136PS)	9AF48 9CQR	27,837.50	5,567.50	33,405.00	34,160.00	31,160.00	Zero [#]	0	25E

WLTP Combined CO₂ (g/km) figures, valid 3 March 2020, are based on a configured vehicle as per pack code for UK with no options fitted.

[#]Zero BiK applies to vehicles registered from 6 April 2020. Corsa-e registrations prior to this date will be 16% BiK.

Please note: On-the-road recommended retail prices (RRP) include number plates and delivery to Retailer of £700.00 (inc. £116.67 VAT), 12 months' Vehicle Excise Duty and new vehicle first registration fee of £55.00. Excludes fuel and insurance. Company Car Benefit in Kind (BiK) rates are monthly based on the standard paint price. Price has been calculated using manufacturer estimates and includes a £3,000.00 OLEV grant which has been deducted from the price of the vehicle (OLEV Grant not available in the Isle of Man). The grant is a government incentive and is subject to withdrawal prior to delivery of your vehicle. Retailers may be required to carry out more than one credit check during the course of the order process. You may be required to place a deposit when placing your order with your supplying Retailer. In the event of a price change, deposit refunds will be governed by your supplying Retailer's policy and as such must be discussed with the supplying Retailer.

*Please note, 11kW models are not due to become available until late 2020.

Corsa-e is not covered by our Price Protection Guarantee. See 'Further Information' page for details.

SAFETY

STANDARD FEATURES – The following features are standard across the entire all-new Corsa range.

Airbags

- Driver's airbag
- Front passenger's airbag
- Front seat side-impact airbags
- Full-size curtain airbags

Seating

- Height-adjustable head restraints

Seatbelts

- Inertia-reel lap and diagonal seatbelts
- 'Seatbelt unfastened' audible warning and warning light

Braking

- Automatic emergency city braking – The system works automatically in conjunction with forward collision alert, at speeds between 3mph and 53mph, and detects both vehicles and pedestrians. If no avoiding action is taken by the driver, at speeds below 19mph the system automatically slows the vehicle to a full stop with emergency braking of 0.9g. At speeds from 19mph to 53mph it brakes automatically to reduce speed by a maximum of 14mph – to reduce speed even further the driver must brake him/herself.

- Anti-lock Braking System (ABS)
- Emergency brake assist – When emergency braking is detected the vehicle automatically applies the maximum possible braking assistance.
- Electronic brakeforce distribution – Automatically apportions the optimum braking force to each wheel.
- Hill start assist – Briefly maintains rear brake pressure to stop the vehicle rolling back when pulling away on an incline.

Child Safety

- Deactivation switch for front passenger's airbag
- ISOFIX child seat mountings incorporating top tether anchor points located on outer rear seats (does not include child seat) – Allows ISOFIX child safety seats to be securely fixed into the car. The ISOFIX mounting system reduces forward movement in an accident and makes the child seat easier to install.
- Child-proof locks on rear doors
- Bonnet/headlight/wiper structure – Designed to reduce pedestrian head and upper body injuries.
- Upper and lower bumper design – Reduces upper and lower leg injuries.

Stability

- Electronic Stability Programme (ESP)
ESP monitors many different inputs to determine when the car starts to lose traction, it can then immediately respond by varying the brake pressure between up to three wheels and adjust the engine output to help correct the loss of traction and improve stability.

Additional ESP features

- Traction control
- Cornering brake control
- Straight line stability control
- Drag torque control – Maintain stability on slippery roads when lifting off the accelerator or changing gear.

Tyre pressure

- Tyre pressure monitoring system.

Vauxhall driver assistance systems are intended to support the driver within the system-imminent limitations. The driver remains responsible for the driving task at all times.

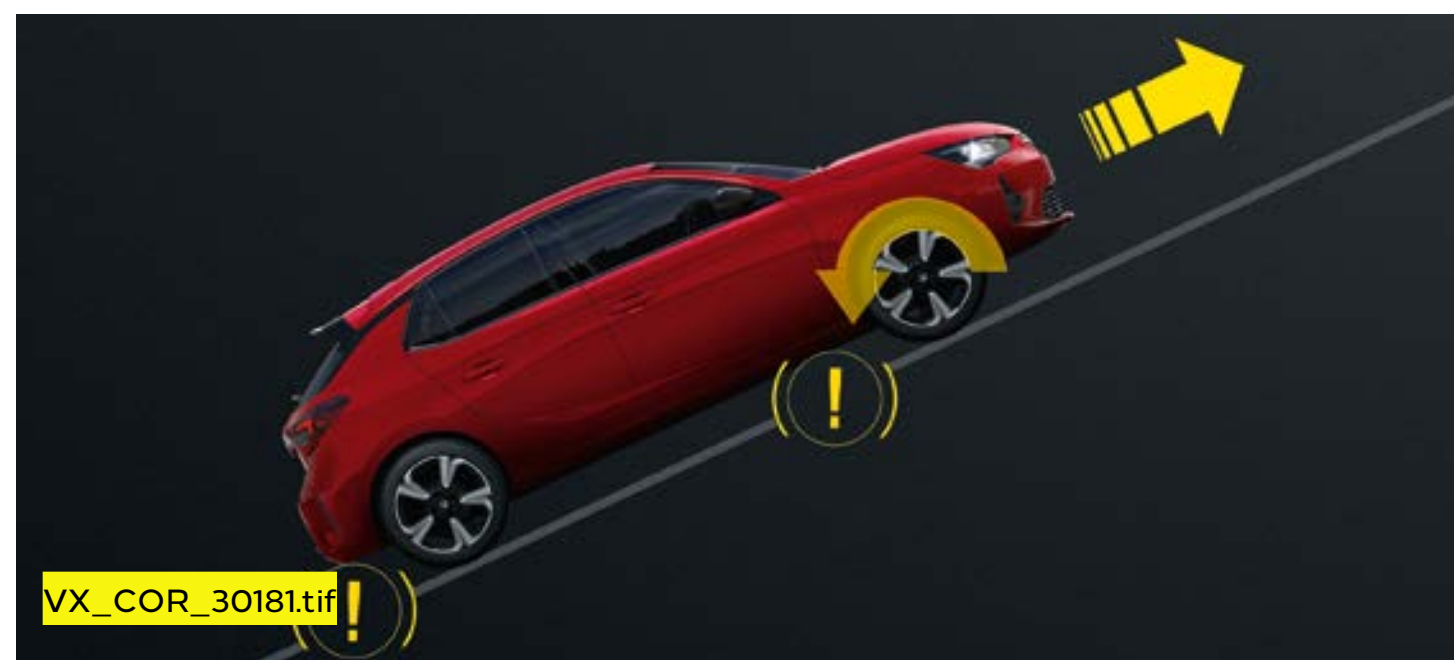

Hill start assist.



ISOFIX child seat mountings.



Automatic emergency city braking.

DRIVER ASSISTANCE

STANDARD FEATURES

The following features are standard across the entire all-new Corsa range. Specific features by model are outlined in the separate tabular information.

Cruise control with speed limiter

With steering wheel mounted controls. Enables you to maintain a constant speed, making it ideal for economical motorway driving.

Front camera system

A range of class-leading driver assistance and safety features are controlled by the front camera system.

Forward collision alert

The system operates automatically from 3mph and gives an audible warning as well as a visual warning when approaching another vehicle too quickly.

Lane departure warning with lane assist

If the driver has not actively steered or signalled, the lane departure warning system provides gentle steering correction and warns when the car moves outside of lane markings at speeds above 40mph.

- Warning light in instrument cluster
- Facia on/off switch

Driver drowsiness system

The system monitors driving time and driving behaviour to help prevent accidents caused by tiredness.

Speed sign recognition

Detects and then displays speed limits, reducing uncertainty and the risk of speeding.

- Recognises different speed signs, including temporary speed restrictions
- Displays reminder in the instrument cluster
- Works in conjunction with the cruise control/speed limiter to help the driver adapt to the recognised speed limit

MODEL SPECIFIC FEATURES

	SE/ SE Nav	SE Premium/ SE Nav Premium	SRI/ SRI Nav	SRI Premium/ SRI Nav Premium	Elite Nav	Elite Nav Premium	Ultimate Nav	Corsa-e SE Nav	Corsa-e Elite Nav
Rain-sensitive windscreen wipers		●		●	●	●	●	●	●
Automatic anti-dazzle rear-view mirror		●		●	●	●	●	●	●
Rear parking distance sensors		●	●	●	●	●	●	●	●
Front and rear parking distance sensors					●	●	●		●
Panoramic rear-view camera					●	●	●		●
Electrically folding door mirrors					●	●	●		●
Side blind spot alert and flank guard					●	●	●		●
Adaptive cruise control							●		
Lane positioning assistant – identifies lane markings and steers the vehicle inside this lane to keep it in the lateral position chosen by the driver.							●		
Electric parking brake – Centre console switch in lieu of handbrake lever	Auto only	Auto only		●	Auto only	●	●	●	●

DRIVER INFORMATION AND SECURITY

STANDARD FEATURES

The following features are standard across the entire all-new Corsa range. Specific features by model are outlined in the separate tabular information.

Driver Information

Instrumentation

- Speedometer and rev counter
- Fuel gauge with low fuel level warning light
- Water temperature gauge with warning light
- Shift-up indication light (manual models only)
 - indicates when to change gear for optimum fuel economy.

Driver information display

(centrally located in instrument cluster)

- Service-due indicator
- Deflation detection system

Multi-function trip computer

(displayed on driver information display)

- Trip mileage
- Vehicle range based on remaining fuel
- Average speed
- Average fuel economy
- Instantaneous fuel economy

Central facia display

(format dependent on infotainment unit)

- Audio information
- Digital clock with automatic RDS time adjustment
- Outside air temperature with ice warning function
- Additional features dependent on infotainment unit (see infotainment for details)

Security

- Electronic engine deadlock immobiliser
- Steering column lock
- Lockable fuel filler flap
- Remote control central door locking
- Two keys – One folding with integral remote

MODEL SPECIFIC FEATURES

	SE/ SE Nav	SE Premium/ SE Nav Premium	SRI/ SRI Nav	SRI Premium/ SRI Nav Premium	Elite Nav	Elite Nav Premium	Ultimate Nav	Corsa-e SE Nav	Corsa-e Elite Nav
DRIVER INFORMATION									
3.5-inch colour instrument cluster	●	●							
7-inch digital instrument cluster			●	●	●	●	●	●	●
SECURITY									
Remote control security alarm system			●	●	●	●	●	●	●
Keyless start								●	
Keyless entry and start				●		●	●		●

CONVENIENCE

STANDARD FEATURES

The following features are standard across the entire all-new Corsa range. Specific features by model are outlined in the separate tabular information.

Interior Convenience

- 12-volt electrical accessory socket
- Driver's and front passenger's sunvisors incorporating vanity mirrors with covers
- Illuminated glovebox with lid

- Interior courtesy light and front map reading lights
- Luggage compartment lighting
- Two-litre open door pockets

Heating and Ventilation

- Air conditioning with air recirculation facility
- Cabin particulate filter – removes dust, airborne particles and pollen
- Four-speed fan with illuminated controls
- Four adjustable facia vents
- Windscreen and side window demist vents

Exterior Convenience

- Solar heat-absorbing windscreen and windows
- Two-speed windscreen wipers with variable intermittent wipe
- Electrically operated front windows with safety autoreverse and one-touch facility
- Glazed tailgate with heated window and wash/wipe facility
- Twin electrically adjustable/heated door mirrors
- Remote control central door locking

MODEL SPECIFIC FEATURES

	SE/ SE Nav	SE Premium/ SE Nav Premium	SRI/ SRI Nav	SRI Premium/ SRI Nav Premium	Elite Nav	Elite Nav Premium	Ultimate Nav	Corsa-e SE Nav	Corsa-e Elite Nav
INTERIOR CONVENIENCE									
Front centre armrest with storage				●		●	●		●
LED ambient lighting					●	●	●		●
HEATING AND VENTILATION									
Electronic climate control				●		●	●	●	●
Heated front seats		●		●	●	●	●		●
Heated steering wheel (excluding auto models)		●		●	●	●	●		●
EXTERIOR CONVENIENCE									
Electrically operated rear windows			●	●	●	●	●		●

EXTERIOR STYLE AND LIGHTING

STANDARD FEATURES

The following features are standard across the entire all-new Corsa range. Specific features by model are outlined in the separate tabular information.

Exterior Styling

- Body-colour front and rear bumpers
- Body-colour door handles and mirror housings

- Chrome logo bar
- Integrated tailgate spoiler

Exterior Lighting

- LED headlights
- High beam assist
- Lights-on audible warning

- LED daytime running lights
- Headlight levelling system
- Rear fog light
- Rear reversing light
- Centre rear brake light
- Hazard warning lights

MODEL SPECIFIC FEATURES

	SE/ SE Nav	SE Premium/ SE Nav Premium	SRI/ SRi Nav	SRi Premium/ SRi Nav Premium	Elite Nav	Elite Nav Premium	Ultimate Nav	Corsa-e SE Nav	Corsa-e Elite Nav
EXTERIOR STYLING									
High gloss black B-pillars			●	●	●	●	●		●
Black roof and A-pillars			●	●	●	●	●		●
Body-colour roof and A-pillars	●	●	No-cost option	No-cost option	No-cost option	No-cost option	No-cost option	●	No-cost option
Black lower side window mouldings	●	●	●	●				●	
Chrome-effect lower side window trim					●	●	●		●
Sports front and rear body styling			●	●					
Sports tailgate spoiler – auto models only	●	●			●	●	●	●	●
Dark-tinted rear side and tailgate windows			●	●	●	●	●		●
Chrome-effect exhaust tailpipe extension			●	●					
EXTERIOR LIGHTING									
Automatic lighting control		●		●	●	●	●		●
LED front fog lights			●	●	●	●	●		●
Automatic headlight levelling system							●		●
IntelliLux LED® Matrix headlights							●		●
LED tail lights			●	●			●		●

INTERIOR STYLING AND COMFORT

SE MODELS



Steering wheel:

- Three-spoke design
- Flat-bottomed
- Leather-covered
- Satin chrome-effect bezel
- Reach and rake adjustable

Facia and door trim:

- Mistral facia
- Jet Black door panels
- Chrome-effect interior door handles

Seat trim:

- Fresez Marvel Black fabric seat trim inserts
- Mistral fabric side bolsters and surrounds

Seating:

- Comfort front seats
- Driver's seat (six-way adjustable):
 - Height (up/down)
 - Reach (fore/aft)
 - Backrest (upright/recline)
- Front passenger's seat (four-way adjustable):
 - Reach (fore/aft)
 - Backrest (upright/recline)
- 60/40 split folding rear seats

SE model illustrated.

SRI MODELS



Steering wheel:

- Three-spoke design
- Flat-bottomed
- Leather-covered
- Satin chrome-effect bezel

Facia and door trim:

- Liquid Palladium facia with Hot Red accents
- Liquid Palladium cloth inserts
- Chrome-effect interior door handles

Seat trim:

- Banda Marvel Black fabric seat trim inserts
- Mistral fabric side bolsters and surrounds
- Signal Red and Dark Titanium seat stitching

Seating:

- Sports-style front seats
- Driver's seat (six-way adjustable):
 - Height (up/down)
 - Reach (fore/aft)
 - Backrest (upright/recline)
- Front passenger's seat (four-way adjustable):
 - Reach (fore/aft)
 - Backrest (upright/recline)
- 60/40 split folding rear seats

SRI model illustrated.

INTERIOR STYLING AND COMFORT

ELITE NAV MODELS



Steering wheel:

- Three-spoke design
- Leather-covered
- Satin chrome-effect bezel
- Reach and rake adjustable

Facia and door trim:

- Silent Black facia with Galvano Chrome inserts
- Silent Black door panels
- Chrome-effect interior door handles

Seat trim:

- Deep Blue/Mistral fabric seat trim inserts
- Premium leather-effect side bolsters and surrounds

Seating:

- Comfort front seats
- Driver's seat (six-way adjustable):
 - Height (up/down)
 - Reach (fore/aft)
 - Backrest (upright/recline)
- Front passenger's seat (six-way adjustable):
 - Height (up/down)
 - Reach (fore/aft)
 - Backrest (upright/recline)
- 60/40 split folding rear seats

Elite Nav Premium model illustrated.

ULTIMATE NAV MODELS



Steering wheel:

- Three-spoke design
- Leather-covered
- Satin chrome-effect bezel
- Reach and rake adjustable

Facia and door trim:

- Jet Black facia with Galvano Chrome inserts
- Jet Black door panels
- Chrome-effect interior door handles

Seat trim:

- Mistral perforated leather seat trim inserts
- Mistral premium leather-effect side bolsters and surrounds

Seating:

- Driver's seat with electrical adjustment and massage function
- Driver's seat (six-way adjustable):
 - Height (up/down)
 - Reach (fore/aft)
 - Backrest (upright/recline)
- Front passenger's seat (six-way manual adjustable):
 - Height (up/down)
 - Reach (fore/aft)
 - Backrest (upright/recline)
- 60/40 split folding rear seats

INFOTAINMENT

STANDARD FEATURES

MULTIMEDIA

STANDARD ON SE, SE PREMIUM,
SRi AND SRi PREMIUM MODELS

Onboard features:

- 7-inch colour touchscreen
- DAB Digital radio
- RDS with Traffic Programme
- AM/FM stereo radio with 25 station presets
- Six speakers
- 20 watts per channel output

Media connections:

- USB connection with iPod control
- Bluetooth® A2DP audio streaming (Advanced Audio Distribution Profile)

Mobile phone portal:

- Bluetooth® connectivity
- Vehicle microphone
- Handsfree calls via steering wheel controls
- Phone book access – Contacts/last calls/missed calls etc. are mirrored on the display and are easily navigated using the touchscreen (features dependent on mobile phone).

Smartphone interface:

- Apple CarPlay™
- Android Auto™
- Smartphone projection that allows operations via voice command, touchscreen and buttons to control apps and music playback.

Additional features:

- Steering wheel-mounted audio controls
- Flexible roof-mounted aerial



Please note, Apple CarPlay screen illustrated on 10-inch colour touchscreen.

INFOTAINMENT

NAV MODEL FEATURES

MULTIMEDIA NAVI WITH 7-INCH TOUCHSCREEN

STANDARD ON SE NAV, SE NAV PREMIUM, SRi NAV, SRi NAV PREMIUM AND ELITE NAV MODELS
STANDARD ON CORSA-E SE NAV MODELS

Features as Multimedia, with the addition of navigation features:

Onboard features:

- 7-inch colour touchscreen

Navigation features:

- Satellite navigation system
- 2D/3D street level mapping
- European coverage
- Points-of-interest search
- Map updates via USB

VAUXHALL CONNECT*

e-Call and b-Call:

Help when you need it, 24/7, 365 days a year, that's what you get with new Vauxhall Connect. In an emergency or breakdown, you'll be put in touch with a trained advisor, with just the touch of a button.

MULTIMEDIA NAVI PRO WITH 10-INCH TOUCHSCREEN

STANDARD ON ELITE NAV PREMIUM AND ULTIMATE NAV MODELS

STANDARD ON CORSA-E ELITE NAV MODELS

Onboard features:

- 10-inch colour touchscreen

Navigation features:

- Satellite navigation system
- 2D/3D street level mapping
- European coverage
- Points-of-interest search
- Map updates via USB

Live navigation and more:

You can also access live navigation services, receive regular vehicle diagnostic info plus there's a host of remote convenience features available through the MyVauxhall app.**

- **Peace of mind:** emergency call, breakdown call and regular vehicle status and information
- **Convenience:** remote functions (e.g. lock/unlock the door).
- **Our additional services for electric vehicles:** trip planning, remote settings or public charging solutions – we keep you going!
- **Smart driving:** enjoy a relaxed ride thanks to live navigation and trip management



VX_COR_30146.tif



VX_COR_e_29955.tif

*Services may require a subscription/fee and are subject to mobile network coverage and availability. Live navigation services are included for 3 years and thereafter are subject to an additional subscription fee.

**Progressively available from January 2020, ask your Retailer for details.

EXTERIOR COLOURS

Navy Blue (G4B)*
Two-coat metallic paint



VX_COR_30164.psd

Summit White (GAZ)**
Brilliant paint £320



VX_COR_30169.psd

Quartz Grey (G4i)**
Two-coat metallic paint £550



VX_COR_30165.psd

Moonstone Grey (G4o)**
Two-coat metallic paint £550



VX_COR_30166.psd

Voltaic Blue (G6L)**
Two-coat metallic paint £550



VX_COR_30167.psd

Diamond Black (G7o)**
Two-coat metallic paint £550



VX_COR_30168.psd

Power Orange (GPQ)**
Two-coat premium paint £650



VX_COR_30170.psd

Hot Red (G1R)**
Two-coat premium paint £650







VX_COR_30163.psd

The colours reproduced may vary slightly from the actual paint colour. As a result they should be used as a guide only. Your Vauxhall Retailer has a comprehensive display of our paint samples.



*Standard exterior paint. **Optional at extra cost.

WHEELS AND TYRES

	SE/ SE Nav	SE Premium/ SE Nav Premium	SRI/ SRI Nav	SRI Premium/ SRI Nav Premium	Elite Nav	Elite Nav Premium	Ultimate Nav
 <p>16-inch silver 4-twinspoke alloy wheels 195/55 R 16 ultra low rolling resistance tyres. Emergency tyre inflation kit (in lieu of spare wheel).</p>	●	●					
 <p>16-inch silver Hurricane 4-twinspoke alloy wheels 195/55 R 16 ultra low rolling resistance tyres. Emergency tyre inflation kit (in lieu of spare wheel).</p>			●				
 <p>17-inch black Hurricane 4-twinspoke alloy wheels 205/45 R 17 tyres. Emergency tyre inflation kit (in lieu of spare wheel).</p>				●			
 <p>16-inch silver 8-spoke alloy wheels 195/55 R 16 tyres. Emergency tyre inflation kit (in lieu of spare wheel).</p>					●		
 <p>17-inch diamond-cut gloss black 5-twinspoke alloy wheels 205/45 R 17 tyres. Emergency tyre inflation kit (in lieu of spare wheel).</p>						●	●
<p>Emergency 15-inch steel spare wheel*</p>	£110	£110	£110	£110	£110	£110	£110

*Not available on Corsa-e electric models.

WHEELS AND TYRES

		Corsa-e SE Nav	Corsa-e Elite Nav
 VX_COR_30174.tif	16-inch silver bi-colour alloy wheels 195/55 R 16 ultra low rolling resistance tyres. Emergency tyre inflation kit (in lieu of spare wheel).	●	
 VX_COR_30178.tif	17-inch bi-colour alloy wheels 205/45 R 17 tyres. Emergency tyre inflation kit (in lieu of spare wheel).		●

PETROL ENGINES

	1.2 (75PS) Start/Stop	1.2 (100PS) Turbo Start/Stop
Capacity	1199cc	1199cc
Maximum power	75PS (55kW) @ 5750rpm	100PS (74kW) @ 5500rpm
Maximum torque	118Nm (87 lb.ft.) @ 2750rpm	205Nm (151 lb.ft.) @ 1750rpm
Configuration	3 cylinders, 4 valves per cylinder, double overhead camshafts	3 cylinders, 4 valves per cylinder, double overhead camshafts
Fuel/induction system	Naturally aspirated with Variable Valve Timing. Multi-point sequential fuel injection	Turbocharger. Multi-point sequential fuel injection
Emission compliance	Euro 6d	Euro 6d
Service interval	12,500 miles or 1 year (whichever occurs sooner)	12,500 miles or 1 year (whichever occurs sooner)

DIESEL ENGINE

	1.5 (102PS) Turbo D Start/Stop BlueInjection
Capacity	1499cc
Maximum power	102PS (75kW) @ 3500rpm
Maximum torque	250Nm (184lb.ft.) @ 1750rpm
Configuration	4 cylinders, 4 valves per cylinder, double overhead camshafts
Fuel/induction system	Turbocharger with intercooler. Variable Valve Timing. Multi-point sequential fuel injection
Emission compliance	Euro 6d
Service interval	20,000 miles or 1 year (whichever occurs sooner)

PERFORMANCE, FUEL ECONOMY AND EMISSIONS

	Performance (manufacturer's figures)		Fuel economy mpg (litres/100km)#		CO ₂ emissions g/km#		Vehicle Excise Duty*		BiK rates from - 2020/21 tax year
	Maximum speed (mph)	Acceleration 0-60mph (sec)	Combined Low	Combined High	Combined Low	Combined High	First year rate	Standard rate	
1.2 (75PS)	108	12.4	47.8 (5.9)	53.3 (5.3)	125	133	£175	£145	28%
1.2 (100PS) Turbo	121	9.3	47.9 (5.9)	52.3 (5.4)	125	134	£175	£145	28%
1.5 (102PS) Turbo D	117	9.6	62.8 (4.5)	70.6 (4.0)	108	117	£155	£145	24%
1.2 (100PS) Turbo automatic	119	10.2	45.6 (6.2)	48.7 (5.8)	133	140	£215	£145	29%

WEIGHTS AND TOWING DATA^{kg}

	Gross vehicle weight	Maximum towing weights Trailer with brakes (without brakes)
1.2 (75PS)	1550	500 (500)
1.2 (100PS) Turbo	1620	1200 (580)
1.5 (102PS) Turbo D	1660	1200 (580)
1.2 (100PS) Turbo automatic	1645	1200 (580)

#Figures shown are for comparison purposes and should only be compared to the fuel consumption and CO₂ values of other cars tested to the same technical standard. The fuel consumption achieved, and CO₂ produced, in real world conditions will depend upon a number of factors including, but not limited to: the accessories fitted (pre and post registration); variations in weather; driving styles and vehicle load. The WLTP (Worldwide Harmonised Light Vehicles Test Procedure) is used to measure fuel consumption and CO₂ figures. The CO₂ figures display a range to reflect the highest value for the highest emitting version with all available options added, through to a minimum value to represent the lowest emitting version in standard specification.

*Correct at time of publication.

Please note: Gross vehicle weight is the total permissible weight of the vehicle including passengers and their luggage. The maximum roof rack loading should not exceed 70kg. The maximum towing weights are based on the ability of the car, with two occupants of 75kg each, to restart on a 12% gradient, which is approximately 1 in 8.3, at sea level. The permitted trailer load applies up to the specified incline and up to an altitude of 1000 metres above sea level. The permissible gross train weight decreases by 10% for every 1000 metres of additional altitude. At altitudes above 1500 metres, the engine output may drop with a corresponding reduction in towing capability. Any extra weight, such as luggage or additional passengers, should be deducted from the maximum towing weight. With a trailer fully loaded, maximum noseweight should not exceed 55kg. Always fit Vauxhall towing attachments and accessories available from your Vauxhall Retailer. They are designed specifically for Vauxhall models and carry a 12-month guarantee. With a trailer fully loaded, maximum noseweight should not exceed 75kg. Always fit Vauxhall towing attachments and accessories available from your Vauxhall Retailer. They are designed specifically for Vauxhall models and carry a 12-month guarantee. During trailer towing do not exceed a maximum speed of 60mph. This speed limit is also applicable in countries with higher permitted speeds for trailer-vehicle combinations. Pay attention to the local speed limits. For trailers with low driving stability and caravans the use of an oscillation damper is strongly recommended.

SPECIFICATIONS

Transmission

- Front-wheel drive
- Five-speed manual gearbox
 - Available on 1.2 (75PS) models.
- Six-speed manual gearbox
 - Available on 1.2 (100PS) Turbo/1.5 (102PS) Turbo D models.
- Eight-speed automatic transmission
 - Available on 1.2 (100PS) Turbo models.

Steering

- Speed-sensitive power-assisted steering

Brakes

- Anti-lock Braking System (ABS)
- Electronic brakeforce distribution
- Emergency brake assist
- Cornering brake control
- Straight line stability control

1.2i (75PS)

Front ventilated discs: 356mm diameter

Rear drums: 203mm diameter

1.2i (100PS)/1.5 (102PS) Turbo D

Front ventilated discs: 381mm diameter

Rear discs: 356mm diameter

Fuel tank capacity

- 1.2 (75PS) 40 litres
- 1.2 (100PS) Turbo 44 litres
- 1.5 (102PS) Turbo D 41 litres

Start/Stop technology

New Corsa's Start/Stop system offers real benefits by improving fuel economy and reducing CO₂ emissions, particularly in town. It does this by automatically stopping the engine when you come to a standstill, and then restarting as you prepare to move off.

Before automatically stopping the engine a number of system checks are carried out to ensure that it is both safe and practical to do so. To ensure safety, the driver must depress the clutch pedal, shift in to neutral, and then release the clutch pedal.

System checks carried out before Auto Stop activates include:

- Start/Stop system is not manually deactivated via the facia button
- Sufficient brake vacuum is available to prevent the car rolling down an incline
- Battery is in good condition and charged
- Outside air temperature and engine temperature are above specified minima
- Electronic climate control (where fitted) is not in maximum heating or maximum cooling mode
- Self-cleaning function of the diesel particulate filter is not active

If all of these conditions are satisfied then the vehicle will Auto Stop.

When you are ready to pull away from standstill, Auto Restart is activated by depressing the clutch pedal.

Whilst at a standstill the vehicle is continually monitored. If necessary, the engine will automatically be restarted. Conditions that would initiate an Auto Restart include:

- Low battery level
- Brake vacuum below specified minimum
- Start/Stop system is manually deactivated
- Stationary for 5.5 minutes

Insurance Groups	All SE	SE Nav Premium	All SRi	SRi Nav Premium	All Elite Nav	Ultimate Nav
1.2 (75PS)	10E	10E	-	-	-	-
1.2 (100PS) Turbo	16E	17E	17E	17E	17E	17E
1.5 (102PS) Turbo D	TBA	TBA	18E	19E	18E	-

CORSA-E SPECIFICATIONS

Single-speed electronic drive selector

As the motor is an all-electric single-speed drive unit, there is no need for multiple gears. Instead, the shifter lets the driver select from the following:

- Park
- Reverse
- Neutral
- Drive
- Braking (for increased regenerative braking)

Drive Mode Selector

The driver can determine the driving style through selecting one of the following modes:

- **Sport:** for a dynamic drive with a responsive throttle and the highest top speed and torque.
- **Normal:** for a balanced drive that offers a compromise between performance and energy efficiency
- **ECO:** for maximum range and energy efficiency. The ECO mode deactivates all unnecessary energy-consuming features and reduces the top speed, torque and overall performance

Drivetrain	Corsa-e
CO ₂ emissions	0g/km
Maximum power kW/PS	100/136
Maximum torque Nm/lb. ft.	260/192
Acceleration 0-60mph (sec)	7.6
Maximum speed mph	93
Transmission	Automatic electric drive with fixed gear ratio
Service interval	Initial service at 8,000 miles/1 year (whichever comes sooner). Thereafter 16,000 miles/2 years (whichever comes sooner)

CORSA-E SPECIFICATIONS*

Charging

Corsa-e comes fitted with a 7.4kW on-board charger as standard together with a Mode 3, 7.4kW cable.

There are also variants equipped with alternative 11kW on-board chargers. However, availability of these variants is strictly limited and deliveries are not expected until late-2020 at best.

The charging flap's Padlock LED lights up when the cable is correctly plugged in and locked and then acts as a user interface to show the charging status via coloured LED lights:

- **White:** welcome light that helps to light up the area, especially useful in dark conditions
- **Flashing green:** charging in progress
- **Solid green:** charging complete
- **Solid blue:** delayed charging toggled; changes to flashing green when charging commences
- **Solid red:** malfunction

The driver may also choose from two settings:

- **Immediate charging (the standard setting):** Starts charging as soon as the vehicle is docked for charging
- **Delayed charging:** This is especially useful for when cheaper electric rates are desired, e.g. charging at night. Simply enter a charging start time

Battery	On-board charger 7.4kW	On-board charger 11kW
Battery energy kWh	50	
EV Range (WLTP High)	209 miles	
Battery consumption (Combined low/high)	16.5-16.8kWh/100km	
Battery warranty	8 years/100,000 miles/70% capacity	
Time to charge		
Domestic Wallbox – Accelerated charger 7kW	7 h 30 min (0-100% battery capacity)	7 h 30 min (0-100% battery capacity)
Public Charging – Accelerated charger 22kW	5 h (15-80%)	3h 20 min (15-80%)
Rapid Charger 50kW**	45 min (15-80%) [†]	45 min (15-80%) [†]
Rapid Charger 100kW**	30 min (15-80%) [†]	30 min (15-80%) [†]



VX_COR_e_30328.tif

The Corsa-e is a battery electric vehicle requiring mains electricity for charging. Range data given has been determined according to WLTP test procedure methodology. The figures shown are intended for comparability purposes only and should only be compared other cars tested to the same technical standard. The range you achieve under real world driving conditions will depend upon a number of factors, including but not limited to: the accessories fitted (pre and post registration); charging frequency; personal driving style; vehicle load and route characteristics; variations in weather; heating/air conditioning; pre-conditioning and battery condition. For more information, contact your local Vauxhall Retailer.

*Provisional data. **You can obtain 15-80% of the vehicle charge in 30 minutes from a 100kW rapid charging station. You can obtain 15-80% of the vehicle charge in 45 minutes from a 50kW rapid charging station. Rapid charging stations are widely available across the UK at various locations and their power rating varies, typically from 50kW and sometimes up to 350kW. [†]The charging time may vary according to the type and power of the charging station, the outside temperature at the charging point and the battery temperature.

DIMENSIONS AND CAPACITIES

All measurements in mm (inches) unless stated otherwise.

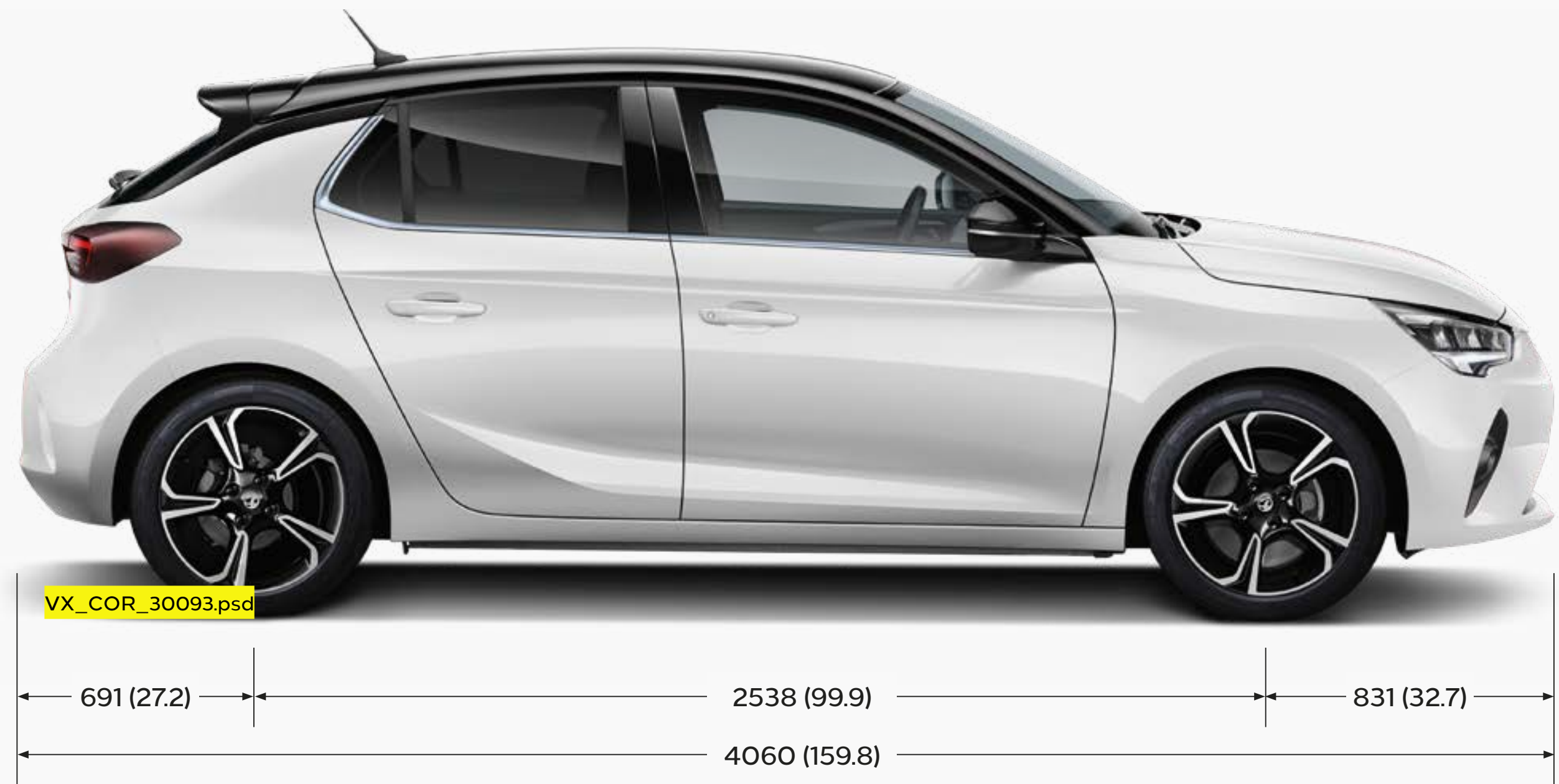

LOADSPACE DIMENSIONS mm (in)	
Maximum length behind rear seats	885 (34.8)
Maximum length rear seats folded	1697 (66.8)
Maximum width	867 (34.1)
Maximum height	574 (22.5)

LUGGAGE CAPACITIES Litres (cu.ft.)	
Rear seats up (under luggage compartment cover)	309 (10.9)
Rear seats folded (to roof)	1118 (39.4)

ACCESSORIES

CHILD SEATS ¹	Total (inc. VAT)
Age Group 0 – up to 13kg/approx. 24 months	£208.00
– ISOFIX Base for Age Group 0	£263.00
Age Group 1 – 9-18kg/approx. 1-3.5 years	£582.00
Age Group 2/3 – 15-36kg/approx. 3-12 years ²	£212.00

SAFETY	
Privacy shades - rear and rear side windows	£131
Parking sensors	
– Rear	£375
– Front	£413
Rear view camera	£595
Alarm system	£430
Safety Pack – first aid kit, hi-visibility vest and small warning triangle	£30
Warning triangle – Small	£12
Warning triangle – Large	£20
First aid kit	£15
Hi-visibility vest	£9
Fire extinguisher with strap – 1kg	£30
Under seat bracket for fire extinguisher	£45
Puncture repair kit	£94
Emergency seat belt cutter and hammer	£17
Philips ADR620 Dash Cam	£95

FLEXCONNECT RANGE	
FlexConnect bracket	£22
FlexConnect hook	£32
FlexConnect coat hanger	£34
FlexConnect folding table	£77
FlexConnect iPad Mini cradle	£109
FlexConnect iPad (2,3 and 4) cradle	£118
FlexConnect iPad Air (1 and 2) cradle	£117
FlexConnect Samsung Galaxy Tab 10.1 cradle	£107

PRACTICAL	Total (inc. VAT)
Rear seat cup holder	£50
Foldable front armrest with storage	£122
Wind deflectors – Front	£71
Boot organiser	£56
Wireless phone charger	tba
Fragrance diffuser	£22
Fragrance cartridge	£17

PROTECTION	
Carpet floor mats – set of four	£30
Rubber floor mats – set of four	£48
Velour floor mats – set of four	£69
Boot liner – Rubber	£49
Boot Liner – Reversible (carpet/rubber)	£70
Rear bumper protection film	tba
Splash Guards – front and rear set ³	£98
Rear seat cover	£37
Boot area cover	£49

TRANSPORT SYSTEMS	Total (inc. VAT)
Roof base carrier ⁴	£145
Roof carriers (requires base carrier)	
Bike roof carrier – Thule Freeride 532	£75
Bike roof carrier – Thule Expert 298	£125
Ski roof carrier (up to 4 pairs)	
– Thule Deluxe 7324	£134
Ski roof carrier (up to 6 pairs)	
– Thule 7326	£176
Hard shell roof boxes (requires base carrier)	
Thule Ocean 80 (320 litre/1330 x 860 x 370mm)	£246
Thule Ocean 200 (450 litre/1750 x 820 x 450mm)	£374
Thule Motion 800 (460 litre/2050 x 840 x 450mm)	from £622
Thule Touring 200 (400 litre/1750 x 820 x 450mm)	£428
Thule Touring 700 (430 litre/2320 x 700 x 420mm)	£492
Tow bar carrier system	
Tow bar with removable tow ball ⁵	£383

STYLING	Total (inc. VAT)
Decal kit – roof and bonnet racing stripes, black or white	£200
Sport pedal covers	
– Manual	£58
– Auto	£41
Body styling kit ⁵ – front and rear bumper attachments and side skirts	£1289
Available in Gloss Black, Summit White, Hot Red, Voltaic Blue or Carbon fibre-effect	
– Exterior door mirror covers ⁷	£115
– Grille bar	£139
– Wheel inserts ³	
Each	£11
Set of four	£33
– Interior rear-view mirror covers ^{3,6,7}	£54
– Interior facia inserts ⁷	£146
– Manual gear knobs ⁸	£75

CHARGING	
Mode 2 Emergency Charging Cable	
– Type G	£584
Mode 3 Charging Cable 7.4 kW	£331
Mode 3 Charging Cable 11 kW	£371
Mode 3 Charging Cable 22 kW	£438
Cable Bag – Mode 2/3	£49
Mode 2 Universal Charger UK Kit 22 kW	£1,087
Universal Charger – Wall Bracket	£110
Universal Charger – Bag	£27
Universal Charger – Safety Lock	£36
Universal Charger – Adapter Type 2	£223
Universal Charger – Adapter Type 3c	£251
Universal Charger – Adapter (various)	£84

Please note: Prices shown are fully fitted and painted, where applicable and include VAT. Please check with your local Vauxhall Retailer for details. It is advisable to ensure your insurance policy is adequate to cover additional fitted accessories. Prices correct at time of publication. Some products may not be available immediately.

¹Restrictions apply to the use of child seats, please consult your Vauxhall Retailer. ²Without transponder. ³Available on petrol and diesel models only. ⁴T-Track adapters may be required for certain Thule roof attachments. Please consult your Vauxhall Retailer for details.

⁵Not compatible with SRi models. ⁶Not available in Gloss Black. ⁷Not available in Carbon fibre-effect. ⁸Available in red and blue only.

COMPANY CAR DRIVER AND FLEET INFORMATION

Benefit in kind company car taxation*

The car benefit charge will be the car's list price (including VAT, options and accessories fitted, delivery to Retailer and number plates, but excluding Vehicle Excise Duty and new vehicle first registration fee) multiplied by the percentage charge for the CO₂ emissions band in which the car falls (see table opposite). Multiply this figure by your personal income tax rate (20%** for Basic Rate, 40%** for Higher Rate) to calculate your annual benefit in kind tax liability.

Example:

Corsa SE 1.5 (102PS) Turbo D Start/Stop (CO₂ emissions 109g/km)

On-the-road RRP	£18,405.00
Deduct: Vehicle Excise Duty	(£155.00)
New vehicle first registration fee	(£55.00)
Effective list price	£18,195.00
Add: Optional two-coat metallic paint	£550.00
List price for tax purposes (P11D value)	£18,745.00
Car benefit charge 2020-21 tax year (24%)	£4,499.00
Benefit in kind tax liability (2020-21 tax year)	
Basic Rate (20%) tax payer	£899.80
Higher Rate (40%) tax payer	£1,799.60

*Lease note this Price Guide provides taxation information as a guide only. Vauxhall does not provide taxation guidance. Drivers should always take professional advice on their own tax position.

BIK FOR SCOTTISH RESIDENTS

Effective 6 April 2018 the Scottish Government have introduced their own BiK taxation structure. This only applies to Company Car Drivers that are Scottish taxpayers. HMRC will determine whether or not an individual is a Scottish taxpayer based on where their main place of residence is.

The BiK rates for Scotland are:

- Over £12,500-£14,549 Starter Rate 19%
- Over £14,549-£24,994 Basic Rate 20%
- Over £24,994-£43,430 Intermediate Rate 21%
- Over £43,430-£150,000 Higher Rate 41%
- Above £150,000 Top Rate 46%

CO ₂ emissions in grams per kilometre	Percentage of cars price to be taxed	
	Non-Diesel† 2020-21 tax year	Diesel†† 2020-21 tax year
Up to 50	12%	-
51-54	13%	-
55-59	14%	-
60-64	15%	-
65-69	16%	-
70-74	17%	-
75-79	18%	22%
80-84	19%	23%
85-89	20%	24%
90-94	21%	25%
95-99	22%	26%
100-104	23%	27%
105-109	24%	28%
110-114	25%	29%
115-119	26%	30%
120-124	27%	31%
125-129	28%	32%
130-134	29%	33%
135-139	30%	34%
140-144	31%	35%
145-149	32%	36%
150-154	33%	37%
155-159	34%	37%
160-164	35%	37%
165-169	36%	37%
170+	37%	37%

CO ₂ emissions in grams per kilometre	Electric range (miles)	Petrol, Electric, RDE2 Diesel††
0	-	0%
1-50	130+	0%
1-50	70-129	3%
1-50	40-69	6%
1-50	30-39	10%
1-50	<30	12%

†Also applies to diesel vehicles that meet the Real Driving Emissions Step 2 (RDE2). ††Applies to vehicles that do not meet the Real Driving Emissions Step 2 (RDE2).

To calculate your own personal liability, search: **Vauxhall BiK**, or click the link below: [Vauxhall BiK Tool](#)

Company Car Driver Free 3 Day Test Drive

Our free[‡] 3 Day Test Drive programme is open to all Company Car Drivers which allows you to choose any model in the current Vauxhall line-up (exclusions apply). With full insurance cover provided, it gives you a meaningful length of time to make an informed decision about your next company car.

Search Vauxhall 3DTD to book your FREE[‡] test drive or click the link the below:

[Vauxhall 3 Day Test Drive](#)

[‡]The free 3 Day Test Drive programme is open to Company Car Drivers and Fleet Decision Makers. Available for UK Mainland only. Terms and conditions apply. Full terms and conditions can be found at vauxhallfleet.co.uk/testdrive/index/terms.

Fleet Toolbox

Discover the facts in our online Toolbox for both Company Car Drivers and Fleet Decision Makers. The Fleet Toolbox has a host of useful calculators, comparators, interactive listings and information. Search Vauxhall Fleet Tools or click the link below:

[Vauxhall Fleet Tool Box](#)

Contact Vauxhall Fleet

Please contact one of our dedicated sales teams who will be happy to help with your particular enquiry.

Company Car Drivers

Call: 0345 111 2020

Email: company-car@vauxhallinfo.co.uk

Telephone lines are open

- Monday to Friday 8:00am-9:00pm

- Saturday and Sunday 9:00am-6:00pm

Fleet Decision Makers

Depending on the size of your fleet of vehicles, we have a dedicated team to handle your enquiries. The lines are open Monday to Friday excluding Bank Holidays.

1-24 vehicles

Call: 0845 076 2254 (8:30am-5:00pm)

25+ vehicles

Call: 0330 587 8222 (8:30am-5:00pm)

Email: vauxhallfleet@vauxhall.co.uk

Special Vehicles (Police, Fire and Ambulance)

Call: 01582 409999 (8:30am-5:00pm)

Email: vauxhallspecialvehicles@vauxhall.co.uk

For more information visit www.vauxhall.co.uk/fleet

FURTHER INFORMATION

On-the-road prices

To eliminate uncertainty about hidden costs when buying a new car, Vauxhall publishes on-the-road recommended retail prices (RRP) and these are shown in the pricing tables within this price guide. These prices include VAT, number plates and delivery to Retailer of £700.00 (including £116.67 VAT), 12 months' Government Vehicle Excise Duty (see opposite for details) and the DVLA new vehicle first registration fee of £55.00.*

Please note: The on-the-road recommended retail price (RRP) does not include fuel supplied by the Retailer, motor insurance or any other goods or services supplied by agreement between the Retailer and the customer.

Price protection

Order a new Vauxhall for build in the current model year (as confirmed by your Retailer) for delivery no more than three months in advance and the price you are quoted is the price you pay. This is irrespective of any subsequent price rises between placing your order and delivery of your new car, but you must take delivery as soon as the car is available.

Please note: Price protection does not apply to Corsa-e/Grandland X hybrid models. Vauxhall Motors Limited is not liable for price adjustments caused by Government changes in the rate of VAT (currently 20%), Vehicle Excise Duty, DVLA new vehicle first registration fee or by any other applicable legislation or regulations.

In the event of an accident

Vauxhall Accident Management helps keep you mobile following an accident. Benefits include vehicle recovery, Vauxhall-approved repairs and contacting your insurer. For more details, visit www.vauxhall.co.uk/AccidentManagement

Free2Move Lease

Whether you're a big company or a small business looking for vehicle financing, Free2Move Lease, our business finance specialists, can deliver exactly what you need.

Free2Move Lease is one of the UK's largest leasing companies and is also a member of the British Vehicle Rental and Leasing Association (BVRLA).

With over 60,000 vehicles in the Free2Move Lease portfolio, Free2Move Lease is able to offer competitive vehicle solutions. In addition, Free2Move Lease also offer innovative connected management of servicing and maintenance.

For further information, please contact your local Vauxhall Retailer or visit www.vauxhall.co.uk/offers-finance/business-leasing.html

Vehicle Excise Duty

The amount of Vehicle Excise Duty (road fund licence) payable on new cars varies depending on the level of carbon dioxide (CO₂) emissions produced by the vehicle. CO₂ emissions are measured in grams per kilometre (g/km) travelled and divided into 13 charging bands shown in the table opposite.

A 'first year rate' of Vehicle Excise Duty is payable on all new cars and in subsequent years the amount payable reverts to the 'standard rate'. From 1 April 2017 the breakpoints for each of these bands have been revised. Also, for vehicles with a list price over £40,000, including factory-fitted options, an additional £320 is payable for the first five years of standard rate payments.

Vehicle Excise Duty*

Band	CO ₂ emissions in grams per kilometre	First year rate		Standard rate	Standard rate
		Petrol [#]	Diesel [†]		Electric
A	0	£0	£0	£0	£0
B	1-50	£10	£25	£145	£0
C	51-75	£25	£110	£145	£0
D	76-90	£110	£135	£145	£0
E	91-100	£135	£155	£145	£0
F	101-110	£155	£175	£145	£0
G	111-130	£175	£215	£145	£0
H	131-150	£215	£540	£145	£0
I	151-170	£540	£870	£145	£0
J	171-190	£870	£1,305	£145	£0
K	191-225	£1,305	£1,850	£145	£0
L	226-255	£1,850	£2,175	£145	£0
M	Over 255	£2,175	£2,175	£145	£0

*Correct at time of issue.

[#]Also applies to diesel vehicles that meet the Real Driving Emissions Step 2 (RDE2).

[†]Applies to vehicles that do not meet the Real Driving Emissions Step 2 (RDE2).

FURTHER INFORMATION

Customer Care Commitment

For added peace of mind, Vauxhall has an innovative Customer Care Commitment that offers the following:

- Three-year vehicle warranty consisting of a one-year/unlimited mileage manufacturer's warranty and a second and third year manufacturer's warranty with a 60,000 miles limitation
- Vauxhall Assistance for 12 months from first registration
- Six years' body panel anti-perforation warranty

Please note: Warranty is only available on vehicles sourced from Vauxhall Motors Limited. Terms and conditions apply – please see your Vauxhall Retailer for details.

Vauxhall Assistance

Vauxhall Assistance is provided automatically with every new Vauxhall for 12 months from first registration and covers everything from accident assistance, roadside recovery and 'at home' service to flat tyres. For even more peace of mind, on Corsa-e models the cover is extended* to 8 years or 100,000 miles, whichever comes first. Even more reason for you to stay calm and let us take care of everything should the need arise. With Vauxhall Assistance help is literally just a free** phone call away, 24 hours a day, 365 days a year!

Protecting the environment

Vauxhall's commitment to the environment is demonstrated by our products' many environmental awards. For even more information on Vauxhall's efforts to achieve an environmentally sustainable future, and how to dispose of your end-of-life vehicle, see www.vauxhall.co.uk/recycling

Vauxhall Care

This all-inclusive service package is available on Vauxhalls under 10 months old (from date of first registration).

This package offers complete peace of mind for the first 3 years of your Vauxhall's life with fixed monthly payments for the plan duration.

- **3 years' Vauxhall servicing** – covers first, second and third annual services. Including a brake-fluid change in the second service
- **2 years' Vauxhall Roadside Assistance** – first year from us
- **First years' MOT[†]** – free of charge by your local Vauxhall Retailer

For full terms and conditions and to sign up, visit: vauxhall.co.uk/vauxhallcare

Vauxhall Service Club

Vauxhall Service Club is available for all Vauxhall owners, and it's free to join. Members benefit from the following:

- 15% off Vauxhall Approved Accessories
- Vauxhall's aged 2-3 Years = 15% off parts and labour
- Vauxhall's aged over 3 Years = 25% off parts and labour
- Half price MOT's (NI excluded)
- Free pre-MOT test inspection (NI only)
- Fixed price AdBlue Refills
 - Car = £14.99
 - Van = £24.99
- Access to the Vauxhall Accident Management Programme
- Online service booking available 24/7 with servicing appointments available within 3 days – [Book Online](#)
- Collection and delivery/onward mobility options
- Complimentary 'Wash and Vac' with all routine services^{††}
- Vauxhall trained technicians
- Genuine Vauxhall parts
- Minimum 12 months warranty on parts and labour
- Regular newsletters with exclusive offers, discounts and competitions

Terms and conditions apply. To join visit: vauxhall.co.uk/serviceclub

Vauxhall Insurance with added reassurance

Comprehensive cover – Summary of benefits

- Competitive premiums
- Repairs by a Vauxhall-trained technician
- Genuine Vauxhall parts, guaranteed for five years when we repair your car within our Approved Repairer Network
- Free courtesy car as standard when using an Approved Repairer[‡]
- 24 hour claims helpline
- Personal Accident benefit
- Cover for audio equipment
- Windscreen cover

Call for a quote on 0330 678 1130^{##}

For more product information

For further information on the Vauxhall range or location of your nearest Vauxhall Retailer please call **0345 600 1500**. Alternatively, details can be found on our website at vauxhall.co.uk

* Terms and conditions apply. Please click [here](#) for full terms and conditions

**Mobile phone users will be charged at their standard tariff.

[†]First years' MOT is not available for Northern Ireland.

^{††}Participating Retailers only.

[‡]Should your car need repairing following an accident we provide a courtesy car (subject to availability) for the duration of the repair. Only genuine Vauxhall parts are used. Terms and conditions apply.

^{##}Calls may be recorded. Vauxhall Insurance Services is a trading name of Europa Group Limited which is authorised and regulated by the Financial Conduct Authority. Europa Group Limited's Financial Services Register number 309794. Registered as a limited company in England and Wales No 03279177. Registered Office: Europa House, Midland Way, Thornbury, Bristol, BS35 2JX.

TRUST VAUXHALL

Company Car Driver Free 3 Day Test Drive:

Our free* 3 Day Test Drive programme is open to all Company Car Drivers. It allows you to choose most models in the current Vauxhall line-up (exclusions apply). With full insurance cover provided, it gives you a meaningful length of time to make an informed decision about your next company car. To book your free* test drive just log on to vauxhall3dtd.co.uk or call 0330 587 8221**.

Fleet Customer Services:

Our dedicated support services for fleet decision-makers include factory demonstrators and information on whole life costs, company car taxation and finance. For further information please call 0330 587 8222.

For More Product Information:

For further information on the Vauxhall range or location of your nearest Vauxhall Retailer please call 0345 600 1500.

TAKE THE NEXT STEP



JOIN US ONLINE

Discover the full Vauxhall range at vauxhall.co.uk >

*The free 3 Day Test Drive programme is open to Company Car Drivers and Fleet Decision-Makers. Available for UK Mainland only. Terms and Conditions apply. Full terms and conditions can be found at vauxhallfleet.co.uk/testdrive/index/terms. **Telephone lines open Monday-Friday 9.00am to 5.00pm excluding Bank Holidays. Calls may be recorded or monitored for quality and/or training purposes.

Privacy Policy: For full details please visit vauxhall.co.uk/privacy

The invoice price, including delivery to Retailer, factory-fitted options, accessories fitted by the Retailer and number plates, is subject to VAT. Some feature descriptions in this guide may refer to, and some illustrations may show, optional equipment not included in the standard delivery. The information contained in this guide was accurate at the time of publication. We reserve the right to make changes in design and equipment. Please note that Vauxhall Retailers are not the agents of Vauxhall Motors Limited and are not authorised to bind Vauxhall Motors Limited by any specific or implied undertaking or representation. It is advisable to ensure that your motor insurance policy provides adequate cover for additional fitted options and accessories. The colours in this guide are only approximate actual colours. Illustrated optional equipment is available at extra charge. Availability, technical features and equipment provided on our vehicles can vary by model. For precise information on the equipment provided on our vehicles, please contact your local Vauxhall Retailer.

NEW ASTRA

Price and Specification Guide | 7 April 2020 | Model Year 2020.5



CONTENTS

To find the information you want use the links below to navigate around the guide:

[RANGE HIGHLIGHTS >](#)

Explore the New Astra range and find your perfect model.

[MODELS >](#)

Find all the information you need about your chosen model.

[PRICES >](#)

Find on-the-road recommended retail prices.

[FEATURES/OPTIONS >](#)

Tailor your chosen model to suit your needs with everything from satellite navigation to rear-view camera and parking sensors.

[EXTERIOR COLOURS >](#)

Add some sparkle to your car with a metallic paint.

[WHEELS AND TYRES >](#)

Why not upgrade to a set of distinctive alloy wheels to give your car more presence.

[PERFORMANCE, FUEL ECONOMY AND EMISSIONS >](#)

Know how many miles you will get around town, the CO₂ figures and the 0-60 time.

[DIMENSIONS >](#)

Ensure your car will fit in the garage and know how much luggage you can take for a long weekend away.

[SPECIFICATIONS >](#)

Towing weights, engine details and other useful details you may need to know.

[ACCESSORIES >](#)

Add some practical touches to your car with our range of quality accessories.

[COMPANY CAR INFORMATION >](#)

Benefit in Kind company car tax, 3 day test drives and P11D.

[FURTHER INFORMATION >](#)

Price protection, vehicle excise duty, our range of additional products and much more.

NEW ASTRA RANGE HIGHLIGHTS



VX_AST_30204.psd

SE	OTR from £19,090
Standard features include:	
Infotainment:	
<ul style="list-style-type: none"> • Multimedia system <ul style="list-style-type: none"> - 7-inch colour touchscreen - AM/FM/DAB digital radio - Bluetooth® audio streaming - Bluetooth® mobile phone portal - Apple CarPlay™/Android Auto™ - USB audio connection • Six speakers 	
Interior convenience/styling:	
<ul style="list-style-type: none"> • Air conditioning • Multi-function trip computer • Cruise control with speed limiter • Steering wheel audio/phone/cruise controls • Steering column adjustable for reach/rake 	
Exterior convenience/styling:	
<ul style="list-style-type: none"> • 16-inch alloy wheels • Dark-tinted rear windows • Automatic lighting control • Electrically operated front/rear windows • Remote control central locking • Electrically adjustable/heated door mirrors • Black roof rails (Sports Tourer) 	
Safety/security:	
<ul style="list-style-type: none"> • Electronic Stability Programme (ESP) • Anti-lock Braking System (ABS) • Six airbags • Hill start assist • ISOFIX child seat mounting points on outer rear seats • Door-to-door illumination • LED daytime running lights • Electronic engine deadlock immobiliser 	



VX_AST_30205.psd

BUSINESS EDITION NAV	OTR from £19,790
Features over SE:	
Infotainment:	
<ul style="list-style-type: none"> • Multimedia Navi system <ul style="list-style-type: none"> - Fully integrated European sat nav system 	
Interior convenience/styling:	
<ul style="list-style-type: none"> • Leather-covered steering wheel • Adjustable front armrest 	



VX_AST_30206.psd

SRi	OTR from £22,100
Features over SE:	
Interior convenience/styling:	
<ul style="list-style-type: none"> • Leather-covered steering wheel • Sports-style front seats • Driver's ergonomic active seat • Front centre armrest • Storage pockets on front seat backs 	
Exterior convenience/styling:	
<ul style="list-style-type: none"> • 17-inch five twin-spoke alloy wheels • Chrome-effect upper window surround • LED headlights • Rain-sensitive windscreen wipers • Automatic lighting control with tunnel detection • Automatic anti-dazzle rear-view mirror • Silver-effect roof rails (Sports Tourer) 	
Safety/security:	
<ul style="list-style-type: none"> • Driving Assistance Pack One featuring intelligent front camera system • Remote control alarm system 	
SRi NAV	OTR from £22,800
SRi Nav models additionally feature:	
<ul style="list-style-type: none"> • Multimedia Navi system <ul style="list-style-type: none"> - Fully integrated European sat nav system 	
<p>Please note: New Astra SRi does not feature dark-tinted rear windows.</p>	

NEW ASTRA RANGE HIGHLIGHTS



VX_AST_30204.psd

SE OTR from £19,090

Standard features include:

Infotainment:

- Multimedia system
 - 7-inch colour touchscreen
 - AM/FM/DAB digital radio
 - Bluetooth® audio streaming
 - Bluetooth® mobile phone portal
 - Apple CarPlay™/Android Auto™
 - USB audio connection
- Six speakers

Interior convenience/styling:

- Air conditioning
- Multi-function trip computer
- Cruise control with speed limiter
- Steering wheel audio/phone/cruise controls
- Steering column adjustable for reach/rake

Exterior convenience/styling:

- 16-inch alloy wheels
- Dark-tinted rear windows
- Automatic lighting control
- Electrically operated front/rear windows
- Remote control central locking
- Electrically adjustable/heated door mirrors
- Black roof rails (Sports Tourer)

Safety/security:

- Electronic Stability Programme (ESP)
- Anti-lock Braking System (ABS)
- Six airbags
- Hill start assist
- ISOFIX child seat mounting points on outer rear seats
- Door-to-door illumination
- LED daytime running lights
- Electronic engine deadlock immobiliser



VX_AST_30207.psd

SRI VX-LINE NAV OTR from £24,400

Features over SE:

Infotainment:

- Multimedia Navi system
 - Fully integrated European sat nav system

Interior convenience/styling:

- Leather-covered steering wheel
- Sports-style front seats
- Driver's ergonomic active seat
- Front centre armrest
- Storage pockets on front seat backs

Exterior convenience/styling:

- 18-inch bi-colour alloy wheels
- High gloss black effect upper window surround
- Front fog lights
- Dark-tinted rear windows
- LED headlights
- Rain-sensitive windscreen wipers
- Automatic lighting control with tunnel detection
- Automatic anti-dazzle rear-view mirror

Safety/security:

- Driving Assistance Pack One featuring intelligent front camera system
- Remote control alarm system



VX_AST_30208.psd

ELITE NAV OTR from £24,160

Features over SE:

Infotainment:

- Multimedia Navi Pro system
 - Fully integrated European sat nav system
 - 8-inch colour touchscreen
- 8-inch colour digital instrument display

Interior convenience/styling:

- Leather seat trim
- Electronic dual-zone climate control
- Heated leather-covered steering wheel
- Heated front/outer rear seats
- Sports-style front seats
- Four-way electrical lumbar adjustment
- Front centre armrest
- Storage pockets on front seat backs
- Electric parking brake
- Two rear USB charging points

Exterior convenience/styling:

- 17-inch multi-spoke alloy wheels
- LED headlights
- Chrome-effect upper window surround
- Rain-sensitive windscreen wipers
- Automatic lighting control with tunnel detection
- Automatic anti-dazzle rear-view mirror

Safety/security:

- Driving Assistance Pack One featuring intelligent front camera system
- Remote control alarm system

Please note: New Astra Elite Nav does not feature dark-tinted rear windows.



VX_AST_30209.psd

ULTIMATE NAV OTR from £26,960

Features over SE:

Infotainment:

- Multimedia Navi Pro system
 - Fully integrated European sat nav system
 - 8-inch colour touchscreen
- Bose premium sound system
- 8-inch colour digital instrument display

Interior convenience/styling:

- Perforated leather seat trim
- Electronic dual-zone climate control
- Heated leather-covered steering wheel
- Heated front/outer rear seats
- Driver's Ergonomic Active Seat with Wellness Functions
- Electric parking brake
- Two rear USB charging points
- Heated windscreen
- Wireless charger for mobile devices

Exterior convenience/styling:

- 18-inch bi-colour alloy wheels
- IntelliLux LED Matrix headlights
- Parking Pack: Front and rear parking distance sensors/Advance park assist/Rear-view camera/Side blind spot alert
- High gloss black effect upper window surround
- Rain-sensitive windscreen wipers
- Automatic lighting control with tunnel detection
- Automatic anti-dazzle rear-view mirror

Safety/security:

- Remote control alarm system

SE



VX_AST_30204.psd



VX_AST_30212.tif

SE ON-THE-ROAD PRICES

	Hatchback		Sports Tourer		Insurance Group
	OTR RRP	CO ₂ (g/km)	OTR RRP	CO ₂ (g/km)	
Petrol					
1.2 (110PS) Turbo	£19,090	120	£20,540	123	16E
1.2 (130PS) Turbo	£19,390	119	-	-	19A
1.4 (145PS) Turbo stepless auto	£21,090	129	-	-	19A
Diesel					
1.5 (105PS) Turbo D	£20,110	113	£21,560	114	16E
1.5 (122PS) Turbo D	£20,535	115	-	-	20A
1.5 (122PS) Turbo D auto	£22,190	131	-	-	20A

Please note: On-the-road recommended retail prices (RRP) include VAT at 20%, number plates and delivery to Retailer of £700.00 (inc. £116.67 VAT), 12 months' Vehicle Excise Duty and new vehicle first registration fee of £55.00. Excludes fuel and insurance.

All diesel models feature BlueInjection, see www.vauxhall.co.uk/adblue

FEATURES

Infotainment:

- Multimedia system
 - 7-inch colour touchscreen
 - AM/FM/DAB digital radio
 - Bluetooth® audio streaming
 - Bluetooth® mobile phone portal
 - Apple CarPlay™/Android Auto™
 - USB audio connection
- Six speakers

Interior convenience/styling:

- Air conditioning
- Multi-function trip computer
- Cruise control with speed limiter
- Steering wheel audio/phone/cruise controls
- Steering column adjustable for reach/rake

Exterior convenience/styling:

- 16-inch alloy wheels
- Automatic lighting control
- Electrically operated front/rear windows
- Remote control central locking
- Electrically adjustable/heated door mirrors
- Black roof rails (Sports Tourer)
- Dark-tinted rear windows

Safety/security:

- Electronic Stability Programme (ESP)
- Anti-lock Braking System (ABS)
- Six airbags
- Hill start assist
- ISOFIX child seat mounting points on outer rear seats
- Tyre pressure monitoring system
- Door-to-door illumination
- LED daytime running lights
- Electronic engine deadlock immobiliser

BUSINESS EDITION NAV



BUSINESS EDITION NAV ON-THE-ROAD PRICES

	Hatchback		Sports Tourer		Insurance Group
	OTR RRP	CO ₂ (g/km)	OTR RRP	CO ₂ (g/km)	
Petrol					
1.2 (110PS) Turbo	£19,790	120	-	-	16E
1.2 (130PS) Turbo	£20,090	120	£21,540	122	19A
1.4 (145PS) Turbo stepless auto	£21,790	129			19A
Diesel					
1.5 (105PS) Turbo D	£20,810	113	-	-	16E
1.5 (122PS) Turbo D	£21,235	116	£22,685	117	20A
1.5 (122PS) Turbo D auto	£22,895	131	-	-	20A

Please note: On-the-road recommended retail prices (RRP) include VAT at 20%, number plates and delivery to Retailer of £700.00 (inc. £116.67 VAT), 12 months' Vehicle Excise Duty and new vehicle first registration fee of £55.00. Excludes fuel and insurance.

All diesel models feature BlueInjection, see www.vauxhall.co.uk/adblue

FEATURES

Infotainment:

- Multimedia Navi system
 - Fully integrated European sat nav system
 - 7-inch colour touchscreen
 - AM/FM/DAB digital radio
 - Bluetooth® audio streaming
 - Bluetooth® mobile phone portal
 - Apple CarPlay™/Android Auto™
 - USB audio connection
- Six speakers

Interior convenience/styling:

- Air conditioning
- Multi-function trip computer
- Cruise control with speed limiter
- Leather-covered steering wheel
- Front centre armrest
- Steering wheel audio/phone/cruise controls
- Steering column adjustable for reach/rake

Exterior convenience/styling:

- 16-inch alloy wheels
- Automatic lighting control
- Electrically operated front/rear windows
- Remote control central locking
- Electrically adjustable/heated door mirrors
- Black roof rails (Sports Tourer)
- Dark-tinted rear windows

Safety/security:

- Electronic Stability Programme (ESP)
- Anti-lock Braking System (ABS)
- Six airbags
- Hill start assist
- ISOFIX child seat mounting points on outer rear seats
- Tyre pressure monitoring system
- Door-to-door illumination
- LED daytime running lights
- Electronic engine deadlock immobiliser

SRI



VX_AST_30206.psd



VX_AST_30236.tif

SRI ON-THE-ROAD PRICES

	Hatchback		Sports Tourer		Insurance Group
	OTR RRP	CO ₂ (g/km)	OTR RRP	CO ₂ (g/km)	
Petrol					
1.2 (110PS) Turbo	£22,100	121	-	-	14E
1.2 (145PS) Turbo	£22,650	121	-	-	17E
1.4 (145PS) Turbo stepless auto	£24,140	131	-	-	16E
Diesel					
1.5 (105PS) Turbo D	£23,120	114	-	-	14E
1.5 (122PS) Turbo D	£23,545	117	-	-	17E
1.5 (122PS) Turbo D auto	£25,205	133	-	-	17E

SRI NAV ON-THE-ROAD PRICES

Petrol					
1.2 (110PS) Turbo	£22,800	121	-	-	14E
1.2 (145PS) Turbo	£23,350	121	£24,800	124	17E
1.4 (145PS) Turbo stepless auto	£24,840	131	£26,290	134	16E
Diesel					
1.5 (105PS) Turbo D	£23,820	114	-	-	14E
1.5 (122PS) Turbo D	£24,245	117	£25,695	118	17E
1.5 (122PS) Turbo D auto	£25,905	133	-	-	17E

Please note: On-the-road recommended retail prices (RRP) include VAT at 20%, number plates and delivery to Retailer of £700.00 (inc. £116.67 VAT), 12 months' Vehicle Excise Duty and new vehicle first registration fee of £55.00. Excludes fuel and insurance. All diesel models feature BlueInjection, see www.vauxhall.co.uk/adblue

FEATURES

Infotainment:

- Multimedia system
 - 7-inch colour touchscreen
 - AM/FM/DAB digital radio
 - Bluetooth® audio streaming
 - Bluetooth® mobile phone portal
 - Apple CarPlay™/Android Auto™
 - USB audio connection
- Six speakers

Interior convenience/styling:

- Air conditioning • Multi-function trip computer
- Sports-style front seats
- Driver's ergonomic active seat
- Front centre armrest
- Storage pockets on front seat backs
- Cruise control with speed limiter
- Steering wheel audio/phone/cruise controls
- Steering column adjustable for reach/rake

Exterior convenience/styling:

- 17-inch five twin-spoke alloy wheels
- Chrome-effect upper window surround
- LED headlights • Rain-sensitive windscreen wipers
- Automatic lighting control with tunnel detection
- Automatic anti-dazzle rear-view mirror
- Remote control central locking
- Electrically operated front/rear windows
- Electrically adjustable/heated door mirrors
- Silver-effect roof rails (Sports Tourer)

Safety/security:

- Driving Assistance Pack One featuring intelligent front camera system
- Electronic Stability Programme (ESP)
- Anti-lock Braking System (ABS)
- Six airbags
- Hill start assist
- ISOFIX child seat mounting points on outer rear seats
- Tyre pressure monitoring system
- LED daytime running lights
- Remote control alarm system
- Electronic engine deadlock immobiliser

SRI NAV MODELS

ADDITIONALLY FEATURE

Infotainment:

- Multimedia Navi system
 - Fully integrated European sat nav system

SRI VX-LINE NAV



VX_AST_30207.psd



VX_AST_30236.tif

SRI VX-LINE NAV ON-THE-ROAD PRICES

	Hatchback		Insurance Group
	OTR RRP	CO ₂ (g/km)	
Petrol			
1.2 (145PS) Turbo	£24,400	123	17E
1.4 (145PS) Turbo stepless auto	£25,890	133	16E
Diesel			
1.5 (122PS) Turbo D	£25,295	118	17E
1.5 (122PS) Turbo D auto	£26,950	134	17E

Please note: On-the-road recommended retail prices (RRP) include VAT at 20%, number plates and delivery to Retailer of £700.00 (inc. £116.67 VAT), 12 months' Vehicle Excise Duty and new vehicle first registration fee of £55.00. Excludes fuel and insurance.

All diesel models feature BlueInjection, see www.vauxhall.co.uk/adblue

FEATURES

Infotainment:

- Multimedia Navi system
 - Fully integrated European sat nav system
 - 7-inch colour touchscreen
 - AM/FM/DAB digital radio
 - Bluetooth® audio streaming
 - Bluetooth® mobile phone portal
 - Apple CarPlay™/Android Auto™
 - USB audio connection
- Six speakers

Interior convenience/styling:

- Air conditioning
- Multi-function trip computer
- Sports-style front seats
- Driver's ergonomic active seat
- Front centre armrest
- Storage pockets on front seat backs
- Cruise control with speed limiter
- Steering wheel audio/phone/cruise controls
- Steering column adjustable for reach/rake

Exterior convenience/styling:

- 18-inch bi-colour alloy wheels
- LED headlights
- Front fog lights
- Dark-tinted rear windows
- High gloss black effect upper window surround
- Rain-sensitive windscreen wipers
- Automatic lighting control with tunnel detection
- Automatic anti-dazzle rear-view mirror
- Remote control central locking
- Electrically operated front and rear windows
- Electrically adjustable/heated door mirrors

Safety/security:

- Driving Assistance Pack One featuring intelligent front camera system
- Electronic Stability Programme (ESP)
- Anti-lock Braking System (ABS)
- Six airbags
- Hill start assist
- ISOFIX child seat mounting points on outer rear seats
- Tyre pressure monitoring system
- LED daytime running lights
- Remote control alarm system
- Electronic engine deadlock immobiliser

ELITE NAV



VX_AST_30208.psd



VX_AST_30419.tif

ELITE NAV ON-THE-ROAD PRICES

	Hatchback		Insurance Group
	OTR RRP	CO ₂ (g/km)	
Petrol			
1.2 (145PS) Turbo	£24,160	121	17E
1.4 (145PS) Turbo stepless auto	£25,650	131	16E
Diesel			
1.5 (122PS) Turbo D	£25,055	117	17E
1.5 (122PS) Turbo D auto	£26,715	132	17E

Please note: On-the-road recommended retail prices (RRP) include VAT at 20%, number plates and delivery to Retailer of £700.00 (inc. £116.67 VAT), 12 months' Vehicle Excise Duty and new vehicle first registration fee of £55.00. Excludes fuel and insurance.

All diesel models feature BlueInjection, see www.vauxhall.co.uk/adblue

FEATURES

Infotainment:

- Multimedia Navi Pro system
 - Fully integrated European sat nav system
 - 8-inch colour touchscreen
 - AM/FM/DAB digital radio
 - Bluetooth® audio streaming
 - Bluetooth® mobile phone portal
 - Apple CarPlay™/Android Auto™
 - USB audio connection
- Six speakers
- 8-inch colour digital instrument display

Interior convenience/styling:

- Leather seat trim
- Electronic dual-zone climate control
- Heated leather-covered steering wheel
- Heated front/outer rear seats
- Sports-style front seats
- Four-way electrical lumbar adjustment
- Front centre armrest
- Multi-function trip computer
- Steering wheel audio/phone/cruise controls
- Electric parking brake
- Cruise control with speed limiter
- Two rear USB charging points

Exterior convenience/styling:

- 17-inch multi-spoke alloy wheels
- Chrome-effect upper window surround
- LED headlights
- Rain-sensitive windscreen wipers
- Automatic lighting control with tunnel detection
- Automatic anti-dazzle rear-view mirror
- Remote control central locking
- Electrically operated front/rear windows
- Electrically adjustable/heated door mirrors

Safety/security:

- Driving Assistance Pack One featuring intelligent front camera system
- Electronic Stability Programme (ESP)
- Anti-lock Braking System (ABS)
- Six airbags
- Remote control alarm system
- Hill start assist
- ISOFIX child seat mounting points on outer rear seats
- Electronic engine deadlock immobiliser
- Tyre pressure monitoring system
- Door-to-door illumination
- LED daytime running lights

ULTIMATE NAV



VX_AST_30209.psd



VX_AST_30420.tif

ULTIMATE NAV ON-THE-ROAD PRICES

	Hatchback		Insurance Group
	OTR RRP	CO ₂ (g/km)	
Petrol			
1.2 (145PS) Turbo	£26,960	124	18E
1.4 (145PS) Turbo stepless auto	£28,450	134	18E
Diesel			
1.5 (122PS) Turbo D	£27,855	119	19E
1.5 (122PS) Turbo D auto	£29,515	135	19E

Please note: On-the-road recommended retail prices (RRP) include VAT at 20%, number plates and delivery to Retailer of £700.00 (inc. £116.67 VAT), 12 months' Vehicle Excise Duty and new vehicle first registration fee of £55.00. Excludes fuel and insurance.

All diesel models feature BlueInjection, see www.vauxhall.co.uk/adblue

FEATURES

Infotainment:

- Multimedia Navi Pro system
 - Fully integrated European sat nav system
 - 8-inch colour touchscreen
 - AM/FM/DAB digital radio
 - Bluetooth® audio streaming
 - Bluetooth® mobile phone portal
 - Apple CarPlay™/Android Auto™
 - USB audio connection
- Bose premium sound system
- 8-inch colour digital instrument display

Interior convenience/styling:

- Perforated leather seat trim
- Electronic dual-zone climate control
- Heated leather-covered steering wheel
- Heated front/outer rear seats
- Sports-style front seats
- Driver's Ergonomic Active Seat with Wellness Functions
- Heated windscreen
- Wireless charger for mobile devices
- Multi-function trip computer
- Steering wheel audio/phone/cruise controls
- Electric parking brake
- Cruise control with speed limiter
- Two rear USB charging points

Exterior convenience/styling:

- 18-inch bi-colour alloy wheels
- High gloss black effect upper window surround
- Rain-sensitive windscreen wipers
- Automatic lighting control with tunnel detection
- Automatic anti-dazzle rear-view mirror
- IntelliLux LED Matrix headlights
- Parking Pack
 - Front and rear parking distance sensors
 - Advance park assist
 - Side blind spot alert
 - Rear-view camera
- Remote control central locking
- Electrically operated front/rear windows
- Electrically adjustable/heated/folding door mirrors
- Dark-tinted rear windows

Safety/security:

- Driving Assistance Pack One featuring intelligent front camera system
- Electronic Stability Programme (ESP)
- Anti-lock Braking System (ABS) • Six airbags
- Remote control alarm system • Hill start assist
- ISOFIX child seat mounting points on outer rear seats
- Electronic engine deadlock immobiliser
- Tyre pressure monitoring system
- Door-to-door illumination
- LED daytime running lights • LED tail lights

NEW ASTRA HATCHBACK PRICES

	Pack Code	Fuel Type	Price (£)	VAT (£)	Total (£)	On-the-road RRP (£)	Financial Year 2020/21 BiK 20% (£)	WLTP Combined CO ₂ (g/km)# - pack code	Insurance Groups
SE									
	9BD68 EJ6L	Petrol	15,133.33	3,026.67	18,160.00	19,090.00	84.87	120	16E
	9BD68 EN6L	Petrol	15,383.33	3,076.67	18,460.00	19,390.00	83.02	119	19A
	9BD68 FAET	Petrol	16,800.00	3,360.00	20,160.00	21,090.00	97.33	129	19A
	9BD68 HO6L	Diesel	15,983.33	3,196.67	19,180.00	20,110.00	82.82	113	16E
	9BD68 HP6L	Diesel	16,337.50	3,267.50	19,605.00	20,535.00	87.98	115	20A
	9BD68 HA9L	Diesel	17,683.33	3,536.67	21,220.00	22,190.00	105.93	131	20A
BUSINESS EDITION NAV									
	9BD68 EJ6N	Petrol	15,716.67	3,143.33	18,860.00	19,790.00	88.02	120	16E
	9BD68 EN6N	Petrol	15,966.67	3,193.33	19,160.00	20,090.00	89.37	120	19A
	9BD68 FAEN	Petrol	17,383.33	3,476.67	20,860.00	21,790.00	100.60	129	19A
	9BD68 HO6N	Diesel	16,566.67	3,313.33	19,880.00	20,810.00	85.73	113	16E
	9BD68 HP6N	Diesel	16,920.83	3,384.17	20,305.00	21,235.00	91.02	116	20A
	9BD68 HA9N	Diesel	18,270.83	3,654.17	21,925.00	22,895.00	109.35	131	20A
SRI									
	9BF68 EJ6S	Petrol	17,641.67	3,528.33	21,170.00	22,100.00	98.40	121	14E
	9BF68 ES6S	Petrol	18,100.00	3,620.00	21,720.00	22,650.00	100.88	121	17E
	9BF68 FAES	Petrol	19,308.33	3,861.67	23,170.00	24,140.00	115.37	131	16E
	9BF68 HO6S	Diesel	18,491.67	3,698.33	22,190.00	23,120.00	95.37	114	14E
	9BF68 HP6S	Diesel	18,845.83	3,769.17	22,615.00	23,545.00	101.02	117	17E
	9BF68 HA9S	Diesel	20,195.83	4,039.17	24,235.00	25,205.00	120.52	133	17E

New Astra's petrol and diesel engines meet the Real Driving Emissions Step 2 (RDE2) standards.

WLTP Combined CO₂ (g/km) figures, valid 3 March 2020, are based on a configured vehicle as per pack code for UK with no options fitted.

#Fuel consumption and CO₂ figures are determined according to the WLTP test cycle. CO₂ figures, BiK values and RRP pricing shown above are for a standard vehicle without any additional optional equipment. CO₂ figures are used to calculate Vehicle Excise Duty (VED) for the first registration of the vehicle and BiK. The addition of optional extras could increase the certified CO₂ emission output. This in turn may affect the amount of VED payable upon registration, and, for company car drivers, the P11D value and the amount of Benefit in Kind (BiK) tax payable. Figures shown are for comparison purposes and should only be compared to the fuel consumption and CO₂ values of other cars tested to the same technical standard. The fuel consumption achieved, and CO₂ produced, in real world conditions will depend upon a number of factors including, but not limited to: the accessories fitted (pre and post registration); variations in weather; driving styles and vehicle load. The WLTP (Worldwide Harmonised Light Vehicles Test Procedure) is used to measure fuel consumption and CO₂ figures. Full data relating to WLTP test cycles can be found at: www.vauxhall.co.uk/wltp

Please note: On-the-road recommended retail prices (RRP) include number plates and delivery to Retailer of £700.00 (inc. £116.67 VAT), 12 months' Vehicle Excise Duty and new vehicle first registration fee of £55.00. Excludes fuel and insurance. Company Car Benefit in Kind (BiK) rates are monthly based on the standard paint price.

NEW ASTRA HATCHBACK PRICES

	Pack Code	Fuel Type	Price (£)	VAT (£)	Total (£)	On-the-road RRP (£)	Financial Year 2020/21 BiK 20% (£)	WLTP Combined CO ₂ (g/km)# - pack code	Insurance Groups
SRI NAV									
1.2 (110PS) Turbo	9BF68 EJ6T	Petrol	18,225.00	3,645.00	21,870.00	22,800.00	101.55	121	14E
1.2 (145PS) Turbo	9BF68 ES6T	Petrol	18,683.33	3,736.67	22,420.00	23,350.00	104.03	121	17E
1.4 (145PS) Turbo stepless auto	9BF68 FAEY	Petrol	19,891.67	3,978.33	23,870.00	24,840.00	118.75	131	16E
1.5 (105PS) Turbo D	9BF68 HO6T	Diesel	19,075.00	3,815.00	22,890.00	23,820.00	98.28	114	14E
1.5 (122PS) Turbo D	9BF68 HP6T	Diesel	19,429.17	3,885.83	23,315.00	24,245.00	104.05	117	17E
1.5 (122PS) Turbo D auto	9BF68 HA9T	Diesel	20,779.17	4,155.83	24,935.00	25,905.00	123.90	133	17E
SRI VX-LINE NAV									
1.2 (145PS) Turbo	9BF68 ES6Y	Petrol	19,558.33	3,911.67	23,470.00	24,400.00	108.75	123	17E
1.4 (145PS) Turbo stepless auto	9BF68 FAEY	Petrol	20,766.67	4,153.33	24,920.00	25,890.00	123.82	133	16E
1.5 (122PS) Turbo D	9BF68 HP6Y	Diesel	20,304.17	4,060.83	24,365.00	25,295.00	108.60	118	17E
1.5 (122PS) Turbo D auto	9BF68 HA9Y	Diesel	21,650.00	4,330.00	25,980.00	26,950.00	128.95	134	17E
ELITE NAV									
1.2 (145PS) Turbo	9BE68 ES6E	Petrol	19,358.33	3,871.67	23,230.00	24,160.00	107.68	121	17E
1.4 (145PS) Turbo stepless auto	9BE68 FAE E	Petrol	20,566.67	4,113.33	24,680.00	25,650.00	122.67	131	16E
1.5 (122PS) Turbo D	9BE68 HP6E	Diesel	20,104.17	4,020.83	24,125.00	25,055.00	107.57	117	17E
1.5 (122PS) Turbo D auto	9BE68 HA9E	Diesel	21,454.17	4,290.83	25,745.00	26,715.00	127.82	132	17E
ULTIMATE NAV									
1.2 (145PS) Turbo	9BE68 ES6U	Petrol	21,691.67	4,338.33	26,030.00	26,960.00	120.28	124	18E
1.4 (145PS) Turbo stepless auto	9BE68 FAEU	Petrol	22,900.00	4,580.00	27,480.00	28,450.00	136.20	134	18E
1.5 (122PS) Turbo D	9BE68 HP6U	Diesel	22,437.50	4,487.50	26,925.00	27,855.00	119.70	119	19E
1.5 (122PS) Turbo D auto	9BE68 HA9U	Diesel	23,787.50	4,757.50	28,545.00	29,515.00	146.22	135	19E

New Astra's petrol and diesel engines meet the Real Driving Emissions Step 2 (RDE2) standards.

WLTP Combined CO₂ (g/km) figures, valid 3 March 2020, are based on a configured vehicle as per pack code for UK with no options fitted.

#Fuel consumption and CO₂ figures are determined according to the WLTP test cycle. CO₂ figures, BiK values and RRP pricing shown above are for a standard vehicle without any additional optional equipment. CO₂ figures are used to calculate Vehicle Excise Duty (VED) for the first registration of the vehicle and BiK. The addition of optional extras could increase the certified CO₂ emission output. This in turn may affect the amount of VED payable upon registration, and, for company car drivers, the P11D value and the amount of Benefit in Kind (BiK) tax payable. Figures shown are for comparison purposes and should only be compared to the fuel consumption and CO₂ values of other cars tested to the same technical standard. The fuel consumption achieved, and CO₂ produced, in real world conditions will depend upon a number of factors including, but not limited to: the accessories fitted (pre and post registration); variations in weather; driving styles and vehicle load. The WLTP (Worldwide Harmonised Light Vehicles Test Procedure) is used to measure fuel consumption and CO₂ figures. Full data relating to WLTP test cycles can be found at: www.vauxhall.co.uk/wltp

Please note: On-the-road recommended retail prices (RRP) include number plates and delivery to Retailer of £700.00 (inc. £116.67 VAT), 12 months' Vehicle Excise Duty and new vehicle first registration fee of £55.00. Excludes fuel and insurance. Company Car Benefit in Kind (BiK) rates are monthly based on the standard paint price.

NEW ASTRA SPORTS TOURER PRICES

	Pack Code	Fuel Type	Price (£)	VAT (£)	Total (£)	On-the-road RRP (£)	Financial Year 2020/21 BiK 20% (£)	WLTP Combined CO ₂ (g/km)# - pack code	Insurance Groups
SE									
1.2 (110PS) Turbo	9BD35 EJ6L	Petrol	16,341.67	3,268.33	19,610.00	20,540.00	91.38	123	16E
1.5 (105PS) Turbo D	9BD35 HO6L	Diesel	17,191.67	3,438.33	20,630.00	21,560.00	88.87	114	16E
BUSINESS EDITION NAV									
1.2 (130PS) Turbo	9BD35 EN6N	Petrol	17,175.00	3,435.00	20,610.00	21,540.00	95.88	122	19A
1.5 (122PS) Turbo D	9BD35 HP6N	Diesel	18,129.17	3,625.83	21,755.00	22,685.00	97.30	117	20A
SRI NAV									
1.2 (145PS) Turbo	9BF35 ES6T	Petrol	19,891.67	3,978.33	23,870.00	24,800.00	110.55	124	17E
1.4 (145PS) Turbo stepless auto	9BF35 FAET	Petrol	21,100.00	4,220.00	25,320.00	26,290.00	125.75	134	16E
1.5 (122PS) Turbo D	9BF35 HP6T	Diesel	20,637.50	4,127.50	24,765.00	25,695.00	110.33	118	17E

New Astra's petrol and diesel engines meet the Real Driving Emissions Step 2 (RDE2) standards.

WLTP Combined CO₂ (g/km) figures, valid 3 March 2020, are based on a configured vehicle as per pack code for UK with no options fitted.

#Fuel consumption and CO₂ figures are determined according to the WLTP test cycle. CO₂ figures, BiK values and RRP pricing shown above are for a standard vehicle without any additional optional equipment. CO₂ figures are used to calculate Vehicle Excise Duty (VED) for the first registration of the vehicle and BiK. The addition of optional extras could increase the certified CO₂ emission output. This in turn may affect the amount of VED payable upon registration, and, for company car drivers, the P11D value and the amount of Benefit in Kind (BiK) tax payable. Figures shown are for comparison purposes and should only be compared to the fuel consumption and CO₂ values of other cars tested to the same technical standard. The fuel consumption achieved, and CO₂ produced, in real world conditions will depend upon a number of factors including, but not limited to: the accessories fitted (pre and post registration); variations in weather; driving styles and vehicle load. The WLTP (Worldwide Harmonised Light Vehicles Test Procedure) is used to measure fuel consumption and CO₂ figures. Full data relating to WLTP test cycles can be found at: www.vauxhall.co.uk/wltp

Please note: On-the-road recommended retail prices (RRP) include number plates and delivery to Retailer of £700.00 (inc. £116.67 VAT), 12 months' Vehicle Excise Duty and new vehicle first registration fee of £55.00. Excludes fuel and insurance. Company Car Benefit in Kind (BiK) rates are monthly based on the standard paint price.

STANDARD FEATURES

ALL MODELS

Driver/passenger airbags

- Driver's airbag • Front passenger's airbag • Two front seat side-impact airbags
 - Full-size curtain airbags for driver and front and outer rear seat passengers
-

Seating

- Height-adjustable front seat head restraints • Three height adjustable rear seat head restraints
 - Anti-submarining ramps in all seats – Prevents occupants sliding underneath the lap belt during a collision.
-

Seatbelts

- Height adjustable front inertia-reel lap and diagonal seatbelts
 - Three inertia-reel lap and diagonal rear seatbelts • Front seatbelts with crash locking tongues
 - Outer rear seatbelt pretensioner system – Pretensioners tighten the seatbelt in the event of an accident limiting forward movement.
 - Front and outer rear seatbelt force limiters – Reduces potential upper body injuries during a frontal impact.
 - Front and rear 'seatbelt unfastened' audible warning and warning light
-

Child safety

- Deactivation switch for front passenger's airbag – Permits the safe use of a child seat in the front passenger seat.
 - ISOFIX child seat mountings incorporating top tether anchor points located on outer rear seats (does not include child seat) – Allows ISOFIX child safety seats to be securely fixed into the car. The ISOFIX mounting system reduces forward movement in an accident and makes the child seat easier to install.
 - Child-proof locks on rear doors
-

Driver/passenger safety

- Energy-absorbing steering column • Pedal release system – Reduces potential injury to the driver's legs and feet during a severe frontal impact.
 - Laminated windscreen • Side-impact protection beams • Reinforced passenger safety cell
 - Deformation zones front and rear • Burst-proof door locks and anti-jam door design
-

Pedestrian safety

- Bonnet/headlight/wiper structure – Designed to reduce pedestrian head and upper body injuries.
 - Upper and lower bumper design – Reduces upper and lower leg injuries.
-

Stability

- Electronic Stability Programme (ESP) – Works in conjunction with the vehicle's electronic braking and engine systems to keep the car stable in many different situations. ESP monitors many different inputs to determine when the car starts to lose traction, it can then immediately respond by varying the brake pressure between up to three wheels and adjust the engine output to help correct the loss of traction and improve stability.

Additional ESP features:

- Traction control • Cornering brake control • Straight line stability control • Rollover mitigation
 - Drag torque control – Maintain stability on slippery roads when lifting off the accelerator or changing gear.
-

Braking

- Anti-lock Braking System (ABS) – Prevents the vehicle's wheels from locking up under heavy braking by momentarily reducing brake pressure at the appropriate wheel, ensuring that you can maintain control of the steering.

Additional ESP features:

The same electronic systems used in the ABS and ESP also deliver exceptional braking performance.

- Emergency brake assist – When emergency braking is detected the vehicle automatically applies the maximum possible braking assistance.
 - Hazard warning lights • Fading brake support – Compensates for the effects of brake fade.
 - Electronic brakeforce distribution – Automatically apportions the optimum braking force to each wheel.
 - Adaptive brake lights – Automatically warns other road users of heavy braking.
 - Hill start assist – Briefly maintains rear brake pressure to stop the vehicle rolling back on an incline.
-

Tyre pressure

- Deflation detection system
-

STANDARD FEATURES

ALL MODELS

Cruise control with speed limiter

Cruise control enables you to maintain a constant speed – making it ideal for economical motorway driving. The speed limiter function can be set to ensure that you do not exceed the speed limit and can be easily overridden if required.

- Steering wheel mounted controls
-

Steering

- Speed sensitive electrically assisted power steering
-

Security features

- ‘Key left in ignition’ audible warning
 - Electronically protected audio equipment
 - Engine deadlock immobiliser
 - Visible Vehicle Identification Number (VIN)
 - Locking wheel bolts for alloy wheels
 - Freewheeling door locks
-

Remote control central locking

- Operates on doors, tailgate and fuel filler flap
 - Deadlocking
 - Central locking activation switch on facia
 - One folding key/one static key each with integral remote control function
-

Instrumentation

- Speedometer
 - Rev counter
 - Digital fuel gauge with low fuel level warning light
 - Digital water temperature gauge with warning light
 - Shift-up/down indication light – Indicates when to change gear for optimum fuel economy.
-

Driver information display (centrally located in instrument cluster)

- Monochrome display (upgraded to colour on Elite Nav and Ultimate Nav models)
 - Displays trip computer data
 - Total mileage
 - Service-due indicator
 - Oil life
 - Tyre pressure monitoring system
-

Multi-function trip computer (displayed on driver information display)

- Trip mileage
 - Vehicle range based on remaining fuel
 - Average speed
 - Average fuel economy
 - Instantaneous fuel economy
 - Driving time
-

Central facia display (format dependent on infotainment unit)

- Digital clock with automatic RDS time adjustment
 - Outside air temperature with ice warning function
 - Audio information
 - Additional features dependent on infotainment unit (see infotainment for details)
-

Seating and comfort

- Reach and rake adjustable steering
 - Steering wheel mounted audio controls
 - Three person layout
 - Three height-adjustable and removable head restraints
 - ISOFIX child seat mountings incorporating top tether anchor points located on outer rear seats (does not include child seat) – Allows ISOFIX child safety seats to be securely fixed into the car. The ISOFIX mounting system reduces forward movement in an accident and makes the child seat easier to install.
 - Child-proof locks on rear doors
-

Heating and ventilation

- Four adjustable facia vents
 - Windscreen demist vents
 - Side window demist vents
 - Heated rear screen with timed cut-off
-

Convenience features

- Front 12-volt electrical accessory socket
 - Driver’s and front passengers sunvisors
 - Front passenger vanity mirror
 - Dipping rear-view mirror
-

Interior lighting

- Central front courtesy light
 - Central rear courtesy light
 - Fade up/fade down
-

Interior storage

- Fold out storage box on driver’s side lower facia
 - Glovebox with lid
 - Front door pockets
 - Two drinks holders in centre console
 - Rear door pockets
 - Storage compartment in centre console
-

Luggage area

- Luggage compartment cover (Hatchback only)
 - Luggage compartment retractable cover (Sports Tourer only)
 - Illuminated load area
 - Fully carpeted load area
 - Interior tailgate handle
 - Four load restraint lashing eyes
 - Twin gas-assisted tailgate struts
-

STANDARD FEATURES

ALL MODELS

Exterior lighting features

- LED daytime running lights
 - Automatic lighting control: When the automatic lighting control is switched on, the system switches between daytime running lights and headlights automatically depending on external lighting conditions.
 - LED side repeat indicators
 - Lights-on audible warning – When keys are removed and driver door opened an audible warning sounds to alert the lights have been left on.
 - Manual headlight beam levelling – Use to adapt headlight range to the vehicle load to prevent dazzling.
 - High-level LED centre rear brake light • Rear fog light • Reversing light • Hazard warning lights
 - Door-to-door illumination: Headlights illuminate the area for an adjustable time after leaving the vehicle.
-

Windscreen wipers

- Two-speed windscreen wipers with variable intermittent wipe • Intermittent rear window wash/wipe
-

Windows

- Electrically operated front and rear windows with safety autoreverse and one-touch up/down facility
 - Heated rear window • Solar heat-absorbing windscreen • Tinted windows
-

Body styling

- Chrome-effect headlight detail • Body-colour door handles • Body-colour door mirrors
 - Body-colour rear roof spoiler
-

FEATURES/OPTIONS

DRIVER ASSISTANCE

	SE	Business Edition Nav	SRI	SRI VX-Line Nav	Elite Nav	Ultimate Nav	Price (£) exc. VAT	Price (£) inc. VAT
Front and rear parking distance sensors • Front and rear parking distance sensors • Audible warning • Distance warning graphic shown in driver information display	○	○	○	○	○		400.00	480.00
Parking Pack (includes front and rear parking distance sensors) Intelligent ultrasonic sensors form part of the solution for today's crowded roads and car parks – delivering exceptional assistance both when parking and protecting you on the open road. Advanced park assist Advanced park assist not only detects suitable parking spaces but also expertly steers into them for you. All you have to do is to drive forward or reverse and apply the brakes. The system works with both parallel and bay parking. • Ultrasonic side sensors with four-metre range • Ultrasonic front and rear parking sensors with a two-metre range • Fully automated steering • Detailed forward/reverse instructions are shown in the instrument cluster Side blind spot alert Side blind spot alert helps prevent potential collisions with other vehicles 'hidden' in the vehicle's side blind spots. If a vehicle enters one of the blind spots a warning light illuminates in the relevant door mirror. • Ultrasonic side sensors with three-metre range • LED warning light in door mirrors • Audible warning is sounded if the indicators are used and the system has detected another vehicle • Electrically folding door mirrors Rear-view camera The rear-view camera gives a clear view of the area behind your car and helps place the car perfectly, without needing to strain your neck. • Activated when reverse gear selected • Camera view appears in infotainment screen • Rear bumper and one-metre grid lines shown as reference points						●		
Electric parking brake • Centre console switch in lieu of handbrake lever • Premium centre console featuring adjustable armrest					●	●		

● = Standard equipment. ○ = Optional at extra cost.

FEATURES/OPTIONS

DRIVER ASSISTANCE CONTINUED

	SE	Business Edition Nav	SRI	SRI VX-Line Nav	Elite Nav	Ultimate Nav	Price (£) exc. VAT	Price (£) inc. VAT
<p>Driving Assistance Pack One</p> <p>A wide range of class-leading driver assistance and safety features are controlled by the front camera system.</p> <p>Forward collision alert with automatic city emergency braking (includes pedestrian protection on Ultimate Nav models) In certain circumstances and at speeds above 5mph warns when approaching another vehicle too quickly. At speeds above 5mph and up to 53mph the system provides additional braking support to help the driver brake more quickly and effectively in an emergency situation. At speeds above 5mph and up to 37mph if no avoiding action is taken by the driver, the system automatically slows the vehicle with emergency braking.</p> <ul style="list-style-type: none"> • Visual warnings – shown in the instrument cluster. • Audible warning • Additional braking support • Low speed collision mitigation braking <p>Following distance indicator Indicates how many seconds you are behind the vehicle in front – helping you maintain a safe distance.</p> <ul style="list-style-type: none"> • Timings are shown in the driver information centre <p>Lane departure warning with lane assist If the driver has not actively steered or signalled, the lane departure warning system warns when the car moves outside of lane markings at speeds above 35mph. The lane keep assist function additionally provides gentle steering correction to help drivers keep in their lane if no active inputs are made.</p> <ul style="list-style-type: none"> • Warning light in the instrument cluster • Audible warning • Steering wheel ‘nudge’ warning • Facia on/off switch • Both systems switch to standby when in road works or when road markings are confused 			●	●	●	●		
<p>Traffic Sign Recognition and Pedestrian Detection</p> <p>Traffic Sign Recognition detects and then displays speed limits, reducing uncertainty and the risk of speeding.</p> <ul style="list-style-type: none"> • Recognises different road signs, including temporary speed restrictions • Displays reminder in the driver information centre <p>Pedestrian Detection uses the camera to detect foreign objects and pedestrians and slows down or brakes the vehicle.</p>			○	○	○	●	229.17	275.00

● = Standard equipment. ○ = Optional at extra cost.

FEATURES/OPTIONS

SECURITY

	SE	Business Edition Nav	SRI	SRI VX-Line Nav	Elite Nav	Ultimate Nav	Price (£) exc. VAT	Price (£) inc. VAT
Remote control ultrasonic security alarm system • Remote control (operates in conjunction with central locking) • Ultrasonic interior sensors • Tilt sensor • Thatcham approved Includes the following: • Twin front reading lights with illuminated switches • Twin rear reading lights with illuminated switches • Ambient LED facia/centre console downlighter • Driver's and front passenger's illuminated vanity mirrors with flip-up covers	○	○	●	●	●	●	216.67	260.00

INTERIOR STYLING

SE interior décor Steering wheel: • Three-spoke design • Satin chrome-effect bezel Facia and door trim: • Black facia with Antelao Sand trim inserts • Instrument panel bar Polar Silver • Black door panels with black Atlantis cloth inserts • Antelao Sand trim inserts on front doors • Chrome-effect interior door handles Seat trim: • Talino fabric seat trim inserts • Plain black fabric side bolsters and surrounds Headlining: • Titanium roof lining	●							
Business Edition Nav interior décor Steering wheel: • Three-spoke design • Leather-covered with accent stitching • Satin chrome-effect bezel Facia and door trim: • Black facia with Antelao Sand trim inserts • Instrument panel bar Polar Silver • Black door panels with black Atlantis cloth inserts • Antelao Sand trim inserts on front doors • Chrome-effect interior door handles Seat trim: • Talino fabric seat trim inserts • Plain black fabric side bolsters and surrounds Headlining: • Titanium roof lining		●						

● = Standard equipment. ○ = Optional at extra cost.

FEATURES/OPTIONS

INTERIOR STYLING CONTINUED

	SE	Business Edition Nav	SRI	SRI VX-Line Nav	Elite Nav	Ultimate Nav	Price (£) exc. VAT	Price (£) inc. VAT
<p>SRI/SRI VX-Line Nav interior décor</p> <p>Steering wheel:</p> <ul style="list-style-type: none"> • Three-spoke design • Leather-covered with accent stitching • Satin chrome-effect bezel <p>Facia and door trim:</p> <ul style="list-style-type: none"> • Black facia with Liquid Palladium trim inserts • Instrument panel bar Piano Black • Silver air vent surrounds • Black door panels with black Atlantis cloth inserts • Liquid Palladium trim inserts on front doors • Chrome-effect interior door handles <p>Seat trim:</p> <ul style="list-style-type: none"> • Formula fabric seat trim inserts • Plain black fabric side bolsters and surrounds <p>Headlining:</p> <ul style="list-style-type: none"> • Titanium roof lining 			●	●				
<p>Elite Nav/Ultimate Nav interior décor with Siena leather seat trim</p> <p>Steering wheel:</p> <ul style="list-style-type: none"> • Three-spoke design • Leather-covered with accent stitching • Satin chrome-effect bezel <p>Facia and door trim:</p> <ul style="list-style-type: none"> • Black facia with Piano black trim inserts • Instrument panel bar Satin Chrome • Silver air vent surrounds • Black door panels with black Leather-effect inserts • Piano black trim inserts on front doors • Chrome-effect interior door handles <p>Seat trim:</p> <ul style="list-style-type: none"> • Black Siena leather seat trim inserts • Black leather-effect side bolsters and surrounds <p>Headlining:</p> <ul style="list-style-type: none"> • Titanium roof lining 					●	●		

● = Standard equipment.

FEATURES/OPTIONS

SEATING AND COMFORT

	SE	Business Edition Nav	SRi	SRi VX-Line Nav	Elite Nav	Ultimate Nav	Price (£) exc. VAT	Price (£) inc. VAT
Comfort front seats Driver's seat (eight way adjustable): • Height (up/down) • Reach (fore/aft) • Backrest recline (upright/incline) • Head restraint (up/down) Front passenger's seat (six way adjustable): • Reach (fore/aft) • Backrest (upright/recline) • Head restraint (up/down)	●	●						
Driver's ergonomic active seat – AGR certified* with sports-style front passenger seat Driver's seat (16-way adjustable): • Height (up/down) • Reach (fore/aft) • Tilt (fore/aft) • Backrest (upright/recline) • Seat cushion extension (fore/aft) • Lumbar adjustment (four-way electrical) • Head restraint (up/down) Front passenger's seat (six way adjustable): • Reach (fore/aft) • Backrest (upright/recline) • Head restraint (up/down)	○	○	●	●			216.67	260.00
Sports-style front seats featuring Siena Leather Driver's and front passenger's seat (12-way adjustable): • Height (up/down) • Reach (fore/aft) • Backrest (upright/recline) • Lumbar adjustment (four-way electrical) • Head restraint (up/down)					●			
• Heated front and outer rear seats					●			
• Heated front and outer rear seats • Centre rear armrest						●		

*AGR (The Campaign for Healthier Backs) is an independent centre of excellence for ergonomics, based in Germany.

● = Standard equipment. ○ = Optional at extra cost.

FEATURES/OPTIONS

SEATING AND COMFORT CONTINUED

	SE	Business Edition Nav	SRI	SRI VX-Line Nav	Elite Nav	Ultimate Nav	Price (£) exc. VAT	Price (£) inc. VAT
Driver's and front passenger's ergonomic active seats – AGR certified* Driver's and front passenger's seat (16-way adjustable): • Height (up/down) • Reach (fore/aft) • Tilt (fore/aft) • Backrest (upright/recline) • Seat cushion extension (fore/aft) • Lumbar adjustment (four-way electrical) • Head restraint (up/down)						●		
Driver's Ergonomic Active Seat with Wellness Functions – AGR certified* Driver's seat additional features: • Massage function via three air cushions • Active ventilation backrest/seat cushion • Electrically operated adjustment with seat memory function • Pneumatically adjustable backrest side bolsters Front passenger's seat additional feature: • Active ventilation backrest/seat cushion						●		
Rear seating • 60/40 split-folding rear seat back	●	●	●	●	●			
• 40/20/40 split-folding rear seat back • FlexFold rear seats with remote electrical release (Sports Tourer only) • Leather trim only						●		

*AGR (The Campaign for Healthier Backs) is an independent centre of excellence for ergonomics, based in Germany.

● = Standard equipment.

FEATURES/OPTIONS

INFOTAINMENT

	SE	Business Edition Nav	SRI	SRI VX-Line Nav	Elite Nav	Ultimate Nav	Price (£) exc. VAT	Price (£) inc. VAT
<p>Multimedia touchscreen infotainment system</p> <p>For use with MP3 players, USB memory sticks, mobile phones and smartphone apps.</p> <p>Onboard features:</p> <ul style="list-style-type: none"> • 7-inch colour touchscreen • DAB digital radio/AM/FM stereo radio with 36 station presets • RDS with Traffic Programme <p>Media connections:</p> <ul style="list-style-type: none"> • USB connection with iPod control • Bluetooth® A2DP audio streaming (Advanced Audio Distribution Profile) <p>Mobile phone portal:</p> <ul style="list-style-type: none"> • Bluetooth® connectivity • Handsfree calls via steering wheel controls • Vehicle microphone • Phone book access – Contacts/last calls/missed calls etc. are mirrored on IntelliLink's display and are easily navigated using the touchscreen (features dependent on mobile phone). <p>Smartphone interface:</p> <ul style="list-style-type: none"> • Apple CarPlay™ • Android Auto™ – Smartphone projection that allows operations via voice command, touchscreen and buttons to control apps and music playback. 	●		●					
<p>Multimedia Navi touchscreen navigation and infotainment system</p> <p>For use with MP3 players, USB memory sticks, mobile phones and smartphone apps.</p> <p>Onboard features:</p> <ul style="list-style-type: none"> • 7-inch colour touchscreen • DAB digital radio/AM/FM stereo radio with 36 station presets • RDS with Traffic Programme <p>Navigation features:</p> <ul style="list-style-type: none"> • Satellite navigation system <p>Media connections:</p> <ul style="list-style-type: none"> • USB connection with iPod control • Bluetooth® A2DP audio streaming (Advanced Audio Distribution Profile) <p>Mobile phone portal:</p> <ul style="list-style-type: none"> • Bluetooth® connectivity • Handsfree calls via steering wheel controls • Vehicle microphone • Phone book access – Contacts/last calls/missed calls etc. are mirrored on IntelliLink's display and are easily navigated using the touchscreen (features dependent on mobile phone). <p>Smartphone interface:</p> <ul style="list-style-type: none"> • Apple CarPlay™ • Android Auto™ – Smartphone projection that allows operations via voice command, touchscreen and buttons to control apps and music playback. 		●	▲	●				

● = Standard equipment. ▲ = Standard on Nav models, see pricing page for details.

FEATURES/OPTIONS



INFOTAINMENT CONTINUED

	SE	Business Edition Nav	SRi	SRi VX-Line Nav	Elite Nav	Ultimate Nav	Price (£) exc. VAT	Price (£) inc. VAT
<p>Multimedia Navi Pro touchscreen navigation and infotainment</p> <p>Onboard features:</p> <ul style="list-style-type: none"> • 8-inch colour touchscreen featuring tablet-like controls including swipe gestures • DAB digital radio/AM/FM stereo radio • RDS with Traffic Programme • 60 configurable favourites including contacts, addresses, playlists and radio stations • Voice control for audio, phone and navigation functions • Stores up to 5 user profiles for simple retrieval <p>Navigation features:</p> <ul style="list-style-type: none"> • Satellite navigation system • Integrated 3D European navigation with Traffic Message Channel TMC/TPEG <p>Media connections:</p> <ul style="list-style-type: none"> • USB connection with iPod control in front centre armrest • Bluetooth® A2DP audio streaming (Advanced Audio Distribution Profile) <p>Mobile phone portal:</p> <ul style="list-style-type: none"> • Bluetooth® connectivity • Handsfree calls via steering wheel controls • Voice control support from connected phone • Phone book access – Contacts/last calls/missed calls etc. are mirrored on Multimedia display and are easily navigated using the touchscreen (features dependent on mobile phone). • SMS read out and reply <p>Instrumentation:</p> <ul style="list-style-type: none"> • 8-inch colour display incorporating speedometer and supplementary audio, phone and navigation information <p>Smartphone interface:</p> <ul style="list-style-type: none"> • Apple CarPlay™ • Android Auto™ 					●	●		
<p>Vauxhall Connect</p> <p>e-Call: Help when you need it, 24/7, 365 days a year, that's what you get with new Vauxhall Connect. In an emergency, you'll be put in touch with a trained advisor, with just the touch of a button.</p>	○	○	○	○	○	○	345.83	415.00
Wireless charger for mobile devices						●		
<p>Bose® Premium Sound System</p> <ul style="list-style-type: none"> • 4x45w channels • Bose® digital amplifier with six channels of customised equalisation • 7 premium speakers • Subwoofer 						●		
Six speakers	●	●	●	●	●			
Twin USB power sockets for rear seat passengers					●	●		

● = Standard equipment. ○ = Optional at extra cost.

FEATURES/OPTIONS

HEATING AND VENTILATION

	SE	Business Edition Nav	SRI	SRI VX-Line Nav	Elite Nav	Ultimate Nav	Price (£) exc. VAT	Price (£) inc. VAT
Air conditioning • Air recirculation facility • Cabin particulate filter – Removes dust, airborne particles and pollen. • Multi-speed fan • Illuminated controls	●	●	●	●				
Electronic climate control including air conditioning • Dual-zone control – Allowing different temperature settings for driver and front passenger. • Advanced predictive logic control system using sun and humidity sensors • Partial air recirculation – Faster warm up/cool down. • Cabin particulate filter – Removes dust, airborne particles and pollen. • Automatic air direction and fan speed with manual override • LCD temperature display • Illuminated controls					●	●		
Winter Pack  • Heated leather-covered steering wheel • Heated front seats – Three temperature settings. • Rear floor heating ducts					●	●		
Climate Pack  • Electronic climate control • Heated windscreen • Winter Pack: including • Heated leather-covered steering wheel • Heated front seats • Rear floor heating ducts			○	○			550.00	660.00

INTERIOR CONVENIENCE/LIGHTING

Automatically dimming anti-dazzle rear-view mirror			●	●	●	●		
Front centre armrest with storage		●	●	●	●	●		
Twin USB power sockets for rear seat passengers – each socket provides 2.1 amps at 5 volts					●	●		
Premium lighting • Twin front reading lights with illuminated switches • Twin rear reading lights with illuminated switches • Ambient LED facia/centre console downlighter • Driver's and front passenger's illuminated vanity mirrors with flip-up covers			●	●	●	●		
• Ambient LED lighting in front doors					●	●		
Interior storage • Storage pockets on front seat backs			●	●	●	●		

● = Standard equipment. ○ = Optional at extra cost.

FEATURES/OPTIONS

EXTERIOR LIGHTING

	SE	Business Edition Nav	SRI	SRI VX-Line Nav	Elite Nav	Ultimate Nav	Price (£) exc. VAT	Price (£) inc. VAT
LED headlights			●	●	●	●		
Standard lighting features • Automatic lighting control with tunnel detection			●	●	●	●		
IntelliLux LED Matrix headlights IntelliLux LED Matrix headlights work with the Driving Assistance Pack One incorporating front camera system, to provide outstanding lighting performance and enhanced safety. Each headlight features a matrix of eight individual LED lights. These lights replace the main beam function and supplement the dipped beam function. Each LED illuminates a separate part of the road ahead meaning that by automatically switching lights on and off, illumination is varied to suit traffic and road conditions. The IntelliLux system calculates which LED lights are activated and deactivated using additional data such as ambient light conditions, vehicle speed, steering angle and when the indicators are used. For example, when the front camera system detects an oncoming vehicle, the individual LED lights that would dazzle the oncoming driver are automatically switched off and then switched back on once the vehicle has passed. All other areas remain fully illuminated. Studies show that the enhanced roadside illumination of IntelliLux LED Matrix headlights give the driver an extra 1.5 seconds of reaction time at 50mph. • Dipped beam, main beam and dynamic lighting: 16 electronically controlled LED lights (eight per headlight) • Driving Assistance Pack One incorporating front camera system • Intelligent main beam control • Automatic headlight levelling • LED tail lights						●		
Every type of driving environment has been considered: • Urban light – With street lighting and speeds up to 34mph, the system automatically enhances the dipped beam function. • Highway light – The system recognises when the car is on a dual carriageway or motorway. At higher speeds the light distribution on the right is reduced to minimise glare from the crash barriers. • Country light – As speeds increase, so does the lighting’s performance. • Static Cornering light – At lower speeds corners and bends are illuminated to match steering inputs. • Parking light – When reversing, additional side-facing lights are activated in the headlights. • Energy saving mode – On Start/Stop models, the IntelliLux LED Matrix system goes into Energy saving mode when the engine is automatically stopped.								
LED tail lights: (standard with IntelliLux LED Matrix headlights)						●		
Front fog lights			○	●	○	○	150.00	180.00

● = Standard equipment. ○ = Optional at extra cost.







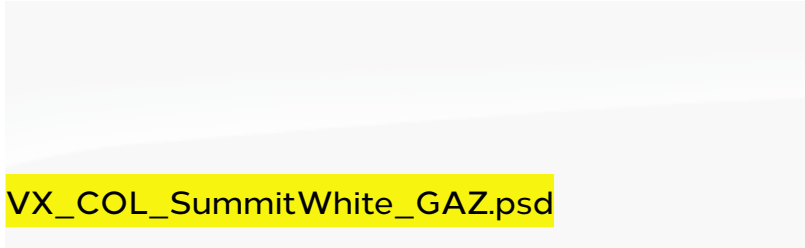

FEATURES/OPTIONS

EXTERIOR CONVENIENCE/STYLING

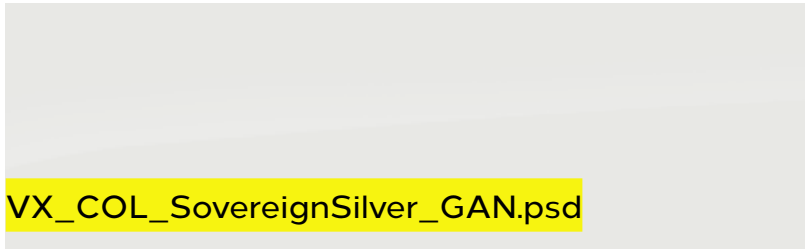
	SE	Business Edition Nav	SRi	SRi VX-Line Nav	Elite Nav	Ultimate Nav	Price (£) exc. VAT	Price (£) inc. VAT
Windscreen wipers • Rain-sensitive windscreen wipers			●	●	●	●		
Door mirrors • Twin electrically adjustable/heated door mirrors • Manually folding door mirrors	●	●	●	●	●			
• Electrically folding door mirrors						●		
Heated windscreen			□	□	○	●	266.67	320.00
Windows • Dark-tinted rear windows	●	●		●		●		
Roof rails (Sports Tourer only) • Black	●	●						
• Silver-effect			●					
Body styling • Chrome-effect upper window surround			●		●			
• Matt black B-pillars • Gloss black C-pillars	●	●						
• Gloss black B-pillars • Gloss black C-pillars			●	●	●	●		
High Gloss Black Pack • High gloss black upper window surround • High gloss black fog light insert (SRi VX Line Nav models only) • High gloss black front grille bar (Ultimate Nav models only)				●		●		

● = Standard equipment. ○ = Optional at extra cost. □ = Available as part of an extra-cost option pack.

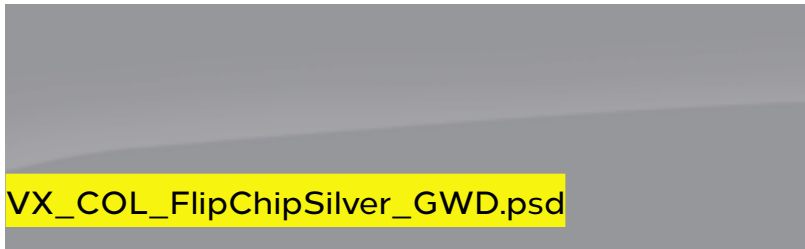

EXTERIOR COLOURS

				SE	Business Edition Nav	SRI	SRI VX-Line Nav	Elite Nav	Ultimate Nav	Price (£) exc. VAT	Price (£) inc. VAT
Solid	 VX_COL_AegeanBlue_G71.psd	Aegean Blue		●	●	●	●	●	●		
Brilliant	 VX_COL_SummitWhite_GAZ.psd	Summit White	 VX_COL_LavaRed_GG2_GG7.psd	Lava Red	○	○	○	○	○	266.67	320.00
Two-coat	 VX_COL_SovereignSilver_GAN.psd	Sovereign Silver metallic	 VX_COL_MineralBlack_GBO_GB9.psd	Mineral Black metallic	○	○	○	○	○	458.33	550.00
	 VX_COL_CosmicGrey_GR5.psd	Cosmic Grey metallic	 VX_COL_NavyBlueG4B.psd	Navy Blue metallic							
Two-coat	 VX_COL_FlipChipSilver_GWD.psd	Flip Chip Silver premium	 VX_COL_HotRed_G1R.psd	Hot Red premium	○	○	○	○	○	541.67	650.00

The colours reproduced may vary slightly from the actual paint colour. As a result they should be used as a guide only. Your Vauxhall Retailer has a comprehensive display of our paint samples.



● = Standard equipment. ○ = Optional at extra cost.

WHEELS AND TYRES

	SE	Business Edition Nav	SRI	SRI VX-Line Nav	Elite Nav	Ultimate Nav	Price (£) exc. VAT	Price (£) inc. VAT
Steel emergency spare wheel (in lieu of emergency tyre inflation kit). Loadspace capacity is reduced.	○	○	○	○	○		91.67	110.00
Full-size 16-inch steel spare wheel (in lieu of emergency tyre inflation kit) Sports Tourer only.	○	○					91.67	110.00
 <p>16-inch alloy wheels</p> <ul style="list-style-type: none"> • 205/55 R 16 tyres • Emergency tyre inflation kit (in lieu of spare wheel) 	●	●						
 <p>17-inch five twin-spoke alloy wheels</p> <ul style="list-style-type: none"> • 225/45 R 17 tyres • Emergency tyre inflation kit (in lieu of spare wheel) 			●					

● = Standard equipment. ○ = Optional at extra cost.

WHEELS AND TYRES

	SE	Business Edition Nav	SRI	SRI VX-Line Nav	Elite Nav	Ultimate Nav	Price (£) exc. VAT	Price (£) inc. VAT
 <p>17-inch multi-spoke alloy wheels</p> <ul style="list-style-type: none"> • 225/45 R 17 tyres • Emergency tyre inflation kit (in lieu of spare wheel) 					●			
 <p>18-inch bi-colour alloy wheels</p> <ul style="list-style-type: none"> • 225/40 R 18 low rolling resistance tyres • Emergency tyre inflation kit (in lieu of spare wheel) 				●		●		

● = Standard equipment.

PERFORMANCE, FUEL ECONOMY AND EMISSIONS

	Performance (manufacturer's figures)		Fuel economy mpg (litres/100km)#		CO ₂ emissions g/km#		Vehicle Excise Duty*		BiK rates from - 2020/21 tax year
	Maximum speed (mph)	Acceleration 0-60mph (sec)	Combined Low	Combined High	Combined Low	Combined High	First year rate	Standard rate	
HATCHBACK									
1.2 (110PS) Turbo	124	10.2	51.4 (5.5)	54.3 (5.2)	120	126	£175	£145	27%
1.2 (130PS) Turbo	134	9.9	51.4 (5.5)	54.3 (5.2)	119	125	£175	£145	26%
1.2 (145PS) Turbo	137	9.7	51.4 (5.5)	54.3 (5.2)	121	126	£175	£145	27%
1.4 (145PS) Turbo auto	130	9.3	47.1 (6.0)	50.4 (5.6)	129	136	£175	£145	28%
1.5 (105PS) Turbo D	124	10.2	62.8 (4.5)	65.7 (4.3)	113	120	£175	£145	25%
1.5 (122PS) Turbo D	130	9.7	60.1 (4.7)	64.2 (4.4)	115	123	£175	£145	26%
1.5 (122PS) Turbo D auto	127	10.2	53.3 (5.3)	56.5 (5.0)	131	138	£215	£145	29%
SPORTS TOURER									
1.2 (110PS) Turbo	124	10.4	50.4 (5.6)	53.3 (5.3)	123	128	£175	£145	27%
1.2 (130PS) Turbo	134	10.1	50.4 (5.6)	53.3 (5.3)	122	128	£175	£145	27%
1.2 (145PS) Turbo	137	9.9	50.4 (5.6)	53.3 (5.3)	124	128	£175	£145	27%
1.4 (145PS) Turbo auto	130	9.5	46.3 (6.1)	48.7 (5.8)	134	139	£215	£145	29%
1.5 (105PS) Turbo D	124	10.4	61.4 (4.6)	65.7 (4.3)	114	120	£175	£145	25%
1.5 (122PS) Turbo D	130	9.9	60.1 (4.7)	64.2 (4.4)	117	123	£175	£145	26%

#Figures shown are for comparison purposes and should only be compared to the fuel consumption and CO₂ values of other cars tested to the same technical standard. The fuel consumption achieved, and CO₂ produced, in real world conditions will depend upon a number of factors including, but not limited to: the accessories fitted (pre and post registration); variations in weather; driving styles and vehicle load. The WLTP (Worldwide Harmonised Light Vehicles Test Procedure) is used to measure fuel consumption and CO₂ figures. The CO₂ figures display a range to reflect the highest value for the highest emitting version with all available options added, through to a minimum value to represent the lowest emitting version in standard specification.

*Correct at time of publication.

DIMENSIONS

Loadspace Dimensions	Hatchback	Sports Tourer
Load floor length (rear seats folded)	1575 (62.0)	1705 (67.1)
Load floor length (behind rear seats)	828 (32.5)	1065 (41.9)
Load area width	1001 (39.4)	1050 (41.3)
Load area height	841 (33.1)	822 (32.3)
Tailgate aperture width (maximum)	1015 (39.9)	1032 (40.6)
Tailgate aperture height	600 (23.6)	747 (29.4)
Luggage Capacities* litres (cu.ft.)		
Rear seat up (under luggage compartment cover)	370 (13.0)	540 (19.0)
Rear seat down (measured to roof)	1210 (42.7)	1630 (57.5)



HATCHBACK



SPORTS TOURER

All measurements are in mm (inches) unless stated otherwise.

*Measured using the ECIE method. When an optional spare wheel is specified loadspace capacity is reduced due to a raised luggage compartment floor.

SPECIFICATIONS

Transmission

Six-speed manual gearbox:

Petrol engines: 1.2 (110/130/145PS) Turbo models

Diesel engines: 1.5 (105/122PS) Turbo D models

Stepless automatic transmission:

The stepless automatic transmission is designed to offer seamless smooth and efficient switching that maximizes fuel economy. The LuK chain along with the Long Travel Torque Converter Damper improve the overall fuel economy, optimize the minimum turbine speed and offer improved isolation. The stepless automatic transmission is available on the 1.4 (145PS) Turbo.

9-Speed Automatic

Available on the new 1.5 (122PS) Turbo D, the new, first in segment 9-speed automatic transmission enables increased drive comfort and improved fuel economy. For extra reliability the transmission has been engineered with reducing the amount of splash losses, hydraulic losses and the amount of torsional vibrations.

Body

Aerodynamic drag co-efficient:

Hatchback – Cd 0.26

Sports Tourer – Cd 0.25

Fuel Tank Capacity

48 litres (10.5 gallons)

Braking and stability

- Electronic Stability Programme (ESP)
- Cornering brake control
- Straight line stability control
- Rollover mitigation
- Drag torque control
- Hill start assist
- Anti-lock Braking System (ABS)
- Emergency brake assist
- Fading brake support
- Electronic brakeforce distribution
- Adaptive brake lights

All models:

Front ventilated discs: 276mm diameter

Rear discs: 264mm diameter

Steering

- Power-assisted steering
- Turning circle (wall-to-wall): – 11.05m (36.2ft.)

Suspension

Front: Independent. Lightweight MacPherson struts with gas-pressure dampers and coil springs. Anti-roll bar.

Rear: Lightweight compound crank rear axle with one-piece, hollow cast trailing arms. Built-in anti-roll bar. Progressive-rate double conical mini-block springs and gas-pressure dampers.

Weights and Towing Data kg

	Gross vehicle weight		Maximum towing weights Trailer with brakes (without brakes)	
	Hatchback	Sports Tourer	Hatchback	Sports Tourer
1.2 (110PS) Turbo	1805	1870	1220 (620)	1100 (660)
1.2 (130PS) Turbo	1805	1870	1350 (620)	1250 (660)
1.2 (145PS) Turbo	1805	1870	1350 (620)	1250 (660)
1.4 (145PS) Turbo stepless auto	1845	1910	N/A	N/A
1.5 (105PS) Turbo D	1880	1945	1300 (660)	1300 (680)
1.5 (122PS) Turbo D	1880	1945	1450 (660)	1450 (680)
1.5 (122PS) Turbo D 9-speed auto	1920	1980	1350 (660)	1250 (680)

Gross vehicle weight is the total permissible weight of the vehicle including passengers and their luggage. The **maximum roof rack loading** should not exceed 75kg. The **maximum towing weights** are based on the ability of the car, with two occupants of 75kg each, to restart on a 12% gradient, which is approximately 1 in 8.3, at sea level. The permitted trailer load applies up to the specified incline and up to an altitude of 1000 metres above sea level. The permissible gross train weight decreases by 10% for every 1000 metres of additional altitude. At altitudes above 1500 metres, the engine output may drop with a corresponding reduction in towing capability. Any extra weight, such as luggage or additional passengers, should be deducted from the maximum towing weight. With a trailer fully loaded, **maximum noseweight** should not exceed 75kg. Always fit Vauxhall towing attachments and accessories available from your Vauxhall Retailer. They are designed specifically for Vauxhall models and carry a 12-month guarantee.

PETROL ENGINES

Engine	1.2 (110PS) Turbo with Start/Stop	1.2 (130PS) Turbo with Start/Stop	1.2 (145PS) Turbo with Start/Stop
Capacity	1199cc	1199cc	1199cc
Maximum power	110PS (81kW) @ 4500rpm	130PS (96kW) @ 5500rpm	145PS (107kW) @ 5500rpm
Maximum torque	195Nm (143lb.ft.) @ 2000-3500rpm	225Nm (165lb.ft.) @ 2000-3500rpm	225Nm (165lb.ft.) @ 2000-3500rpm
Configuration	3 cylinders, 4 valves per cylinder, double overhead camshafts	3 cylinders, 4 valves per cylinder, double overhead camshafts	3 cylinders, 4 valves per cylinder, double overhead camshafts
Fuel/induction system	Turbocharger. Variable Valve Timing (VVT). Spark ignited direct injection (SIDI)	Turbocharger. Variable Valve Timing (VVT). Spark ignited direct injection (SIDI)	Turbocharger. Variable Valve Timing (VVT). Spark ignited direct injection (SIDI)
Emission compliance	Euro 6d	Euro 6d	Euro 6d
Service interval	20,000 miles or 1 year (whichever occurs sooner)	20,000 miles or 1 year (whichever occurs sooner)	20,000 miles or 1 year (whichever occurs sooner)

Engine	1.4 (145PS) Turbo with Start/Stop stepless automatic transmission
Capacity	1342cc
Maximum power	145PS (107kW) @ 5000-6000rpm
Maximum torque	236Nm (174lb.ft.) @ 1500-3500rpm
Configuration	3 cylinders, 4 valves per cylinder, double overhead camshafts
Fuel/induction system	Turbocharger. Variable Valve Timing (VVT). Spark ignited direct injection (SIDI)
Emission compliance	Euro 6d
Service interval	20,000 miles or 1 year (whichever occurs sooner)

DIESEL ENGINES

Engine	1.5 (105PS) Turbo D with Start/Stop	1.5 (122PS) Turbo D with Start/Stop 6-speed manual	1.5 (122PS) Turbo D with Start/Stop 9-speed automatic
Capacity	1496cc	1496cc	1496cc
Maximum power	105PS (77kW) @ 3250rpm	122PS (90kW) @ 3500rpm	122PS (90kW) @ 3500rpm
Maximum torque	260Nm (191lb.ft.) @ 1500-2500rpm	300Nm (221lb.ft.) @ 1750-2500rpm	285Nm (210lb.ft.) @ 1500-2750rpm
Configuration	3 cylinders, 4 valves per cylinder, double overhead camshafts	3 cylinders, 4 valves per cylinder, double overhead camshafts	3 cylinders, 4 valves per cylinder, double overhead camshafts
Fuel/induction system	Turbocharger. Common rail fuel injection	Turbocharger. Common rail fuel injection	Turbocharger. Common rail fuel injection
Emission compliance	Euro 6d	Euro 6d	Euro 6d
Service interval	20,000 miles or 1 year (whichever occurs sooner)	20,000 miles or 1 year (whichever occurs sooner)	20,000 miles or 1 year (whichever occurs sooner)

ACCESSORIES

CHILD SEATS¹	Total (inc. VAT)
BABY-SAFE ² – 0-13kg/birth to 15 months	£152
– ISOFIX base	£263
DUO ISOFIX ² – 9-18kg/9 months to 4 years	
with top tether kit	£402
KID ² –15-36kg or 4 to 12 years	£182
INTERIOR	
PowerFlex bar	from £116
Smartphone holder ³	£51
Air freshener holder ³	£44
Air freshener refill	£13
Cupholder insert	
– Tissue	£17
– Notepad	£17
– Make-up	£17
Interior trim kit – Shaded Maori	£147
SAFETY	
Parking sensors	
– four fully flush front bumper mounted sensors	£343
– four fully flush rear bumper mounted sensors	£343
Safety Pack – first aid kit, warning triangle, hi-visibility vest, Vauxhall bag	£30
First aid kit	£15
Warning triangle – small	£12
Fire extinguisher – 2kg	£39
Hi-visibility vest	£9
Tyre repair kit	£156

FLEXCONNECT RANGE	Total (inc. VAT)
FlexConnect bracket	£22
FlexConnect hook	£32
FlexConnect coat hanger	£34
FlexConnect folding table	£77
FlexConnect iPad Mini cradle	£109
FlexConnect iPad (1-4) cradle	£118
FlexConnect iPad Air cradle	£117
FlexConnect Samsung Galaxy cradle	£107
PRACTICAL	
Spare bulb kit ⁴	£39
Stretch tow rope – 3000kg	£36
Privacy shades	
– rear window (Hatchback)	£98
– rear side windows (Hatchback)	£86
– rear window (Sports Tourer)	£97
– rear side windows (Sports Tourer)	£109
STYLING	
Door sill plates (Hatchback)	£43
Illuminated door sill plates	£151
Stainless steel pedal covers	
– manual	£160
– automatic	£21

PROTECTION	Total (inc. VAT)
Rubber floor mats – set of four	£60
Velour floor mats – set of four	£64
Economy floor mats – set of four	£30
Cargo liner ⁵	
– Hatchback	£106
– Sports Tourer	£103
Cargo net – horizontal	£22
Cargo net – sidewall	£18
Cargo net – vertical (Sports Tourer)	£80
Tyre valve covers with Vauxhall logo (set of 4)	£24
Load compartment storage tray	
– hatchback only ⁶	£79
Splash Guards	
– front	£50
– rear ⁷ (Hatchback)	£54
– rear (Sports Tourer)	£58
Dog guard (Sports Tourer)	£221
Door mirror caps	
– Black	£95
– White	£132
Bumper load protection foil	£61
ALLOY WHEELS	
(set of four with centre caps)⁸	
17-inch 10 V-spoke	£1,032
18-inch 10 double-spoke	£1,618

TRANSPORT SYSTEMS	Total (inc. VAT)
Roof base carrier	
– Hatchback	£221
– Sports Tourer	£233
Roof carriers (requires base carrier)	
Bike roof carrier – Thule Freeride 532	£78
Surf board roof carrier – Thule 833	£82
Kayak roof carrier – Thule 837	£172
Ski roof carrier – up to 4 pairs (400mm wide) – Thule 7324	£161
Ski roof carrier – up to 6 pairs (600mm wide) – Thule 7326	£190
Hard shell roof boxes (requires base carrier)	
Thule Ocean 80 (320 litre/1330 x 860 x 370mm)	£154
Thule Ocean 200 (450 litre/1750 x 820 x 450mm)	£323
Thule Motion 800 (460 litre/2050 x 840 x 450mm)	from £463
Thule Touring 200 (400 litre/1750 x 820 x 450mm)	£338
Thule Touring 700 (430 litre/2320 x 700 x 420mm)	£384
Tow bar carrier system	
Fixed tow bar ⁹ (Sports Tourer)	£768
Detachable tow bar	from £715

Please note: Prices shown are fully fitted and painted, where applicable and include VAT. Please check with your local Vauxhall Retailer for details. It is advisable to ensure your insurance policy is adequate to cover additional fitted accessories. Prices correct at time of publication.

¹Restrictions apply to the use of child seats, please consult your Vauxhall Retailer or request a copy of the Child seats brochure. ²Without transponder. ³Only for use with PowerFlex Bar. ⁴Excludes xenon headlight bulb for models with Adaptive Forward Lighting (AFL). ⁵On Hatchback – for vehicles with spare wheel. For vehicles without spare wheel, load compartment storage tray required to use cargo liner. ⁶For vehicles without spare wheel. ⁷Not available with certain exterior styling products. ⁸Different tyres and locking wheel bolts/nuts may be required at extra cost. Price excludes new tyres and locking wheel bolts/nuts, includes static wheel balancing. ⁹Available with 13-pin electrics. Sports Tourer only. Please consult your Vauxhall Retailers for details.

COMPANY CAR DRIVER AND FLEET INFORMATION

High spec, low P11D

As a business and company car driver, you'll find all of our models are seriously fit for fleet; we're talking very low P11D values, generous standard specification and high-tech engines designed for great fuel economy and low emissions – and that's just to get you started.

To get access to even more spec as standard, simply take a step up in the range – low P11D values will continue to apply.

Drivers and businesses all have unique requirements and by taking advantage of low whole-life costs and low company car driver taxation you can get in the driving seat with the spec to suit.

Company Car Driver Free 3 Day Test Drive

Our free* 3 Day Test Drive programme is open to all Company Car Drivers which allows you to choose any model in the current Vauxhall line-up (exclusions apply). With full insurance cover provided, it gives you a meaningful length of time to make an informed decision about your next company car.

Search Vauxhall 3DTD to book your FREE* test drive or click the link the below:

[Vauxhall 3 Day Test Drive](#)

*The free 3 Day Test Drive programme is open to Company Car Drivers and Fleet Decision Makers. Available for UK Mainland only. Terms and conditions apply. Full terms and conditions can be found at vauxhallfleet.co.uk/testdrive/index/terms.

Benefit in kind company car taxation**

The car benefit charge will be the car's list price (including VAT, options and accessories fitted, delivery to Retailer and number plates, but excluding Vehicle Excise Duty and new vehicle first registration fee) multiplied by the percentage charge for the CO₂ emissions band in which the car falls (see table opposite). Multiply this figure by your personal income tax rate (20%[†] for Basic Rate, 40%[†] for Higher Rate) to calculate your annual benefit in kind tax liability.

Example:

New Astra Business Edition Nav 1.5 (105PS) Turbo D 5-door hatchback (CO₂ emissions 113g/km)

On-the-road RRP	£20,810.00
Deduct: Vehicle Excise Duty	(£175.00)
New vehicle first registration fee	(£55.00)
Effective list price	£20,580.00
Add: Optional two-coat metallic paint	£550.00
List price for tax purposes (P11D value)	£21,130.00
Car benefit charge 2020–21 tax year (25%)	£5,283.00

Benefit in kind tax liability (2020–21 tax year)	
Basic Rate (20%) tax payer	£1,056.60
Higher Rate (40%) tax payer	£2,113.20

**Please note this Price Guide provides taxation information as a guide only. Vauxhall does not provide taxation guidance. Drivers should always take professional advice on their own tax position.

[†]Excludes residents of Scotland.

BIK FOR SCOTTISH RESIDENTS

Effective 6 April 2018 the Scottish Government have introduced their own BiK taxation structure. This only applies to Company Car Drivers that are Scottish taxpayers. HMRC will determine whether or not an individual is a Scottish taxpayer based on where their main place of residence is.

The BiK rates for Scotland are:

- Over £12,500–£14,549 Starter Rate 19%
- Over £14,549–£24,994 Basic Rate 20%
- Over £24,994–£43,430 Intermediate Rate 21%
- Over £43,430–£150,000 Higher Rate 41%
- Above £150,000 Top Rate 46%

CO ₂ emissions in grams per kilometre	Percentage of cars price to be taxed	
	Non-Diesel ^{††} 2020-21 tax year	Diesel [†] 2020-21 tax year
Up to 50	12%	–
51-54	13%	–
55-59	14%	–
60-64	15%	–
65-69	16%	–
70-74	17%	–
75-79	18%	22%
80-84	19%	23%
85-89	20%	24%
90-94	21%	25%
95-99	22%	26%
100-104	23%	27%
105-109	24%	28%
110-114	25%	29%
115-119	26%	30%
120-124	27%	31%
125-129	28%	32%
130-134	29%	33%
135-139	30%	34%
140-144	31%	35%
145-149	32%	36%
150-154	33%	37%
155-159	34%	37%
160-164	35%	37%
165-169	36%	37%
170+	37%	37%

Fleet Toolbox

Discover the facts in our online Toolbox for both Company Car Drivers and Fleet Decision Makers. The Fleet Toolbox has a host of useful calculators, comparators, interactive listings and information.

Search Vauxhall Fleet Tools or click the link below:

[Vauxhall Fleet Tool Box](#)

Contact Vauxhall Fleet

Please contact one of our dedicated sales teams who will be happy to help with your particular enquiry.

Company Car Drivers

Call: 0345 111 2020

Email: company-car@vauxhallinfo.co.uk

Telephone lines are open

– Monday to Friday 8:00am–9:00pm

– Saturday and Sunday 9:00am–6:00pm

Fleet Decision Makers

Depending on the size of your fleet of vehicles, we have a dedicated team to handle your enquiries. The lines are open Monday to Friday excluding Bank Holidays.

1-24 vehicles

Call: 0845 076 2254 (8:30am–5:00pm)

25+ vehicles

Call: 0330 587 8222 (8:30am–5:00pm)

Email: vauxhallfleet@vauxhall.co.uk

Special Vehicles (Police, Fire and Ambulance)

Call: 01582 409999 (8:30am–5:00pm)

Email: vauxhallspecialvehicles@vauxhall.co.uk

^{††}Also applies to diesel vehicles that meet the Real Driving Emissions Step 2 (RDE2). [†]Applies to vehicles that do not meet the Real Driving Emissions Step 2 (RDE2).

To calculate your own personal liability, search:

Vauxhall BiK, or click the link below:

[Vauxhall BiK Tool](#)

For more information visit www.vauxhall.co.uk/fleet

FURTHER INFORMATION

On-the-road prices

To eliminate uncertainty about hidden costs when buying a new car, Vauxhall publishes on-the-road recommended retail prices (RRP) and these are shown in the pricing tables within this price guide. These prices include VAT, number plates and delivery to Retailer of £700.00 (including £116.67 VAT), 12 months' Government Vehicle Excise Duty (see opposite for details) and the DVLA new vehicle first registration fee of £55.00.*

Please note: The on-the-road recommended retail price (RRP) does not include fuel supplied by the Retailer, motor insurance or any other goods or services supplied by agreement between the Retailer and the customer.

Price protection

Order a new Vauxhall for build in the current model year (as confirmed by your Retailer) for delivery no more than three months in advance and the price you are quoted is the price you pay. This is irrespective of any subsequent price rises between placing your order and delivery of your new car, but you must take delivery as soon as the car is available. Vauxhall Motors Limited is not liable for price adjustments caused by Government changes in the rate of VAT (currently 20%), Vehicle Excise Duty, DVLA new vehicle first registration fee or by any other applicable legislation or regulations.

In the event of an accident

Vauxhall Accident Management helps keep you mobile following an accident. Benefits include vehicle recovery, Vauxhall-approved repairs and contacting your insurer. For more details, visit www.vauxhall.co.uk/AccidentManagement

Free2Move Lease

Whether you're a big company or a small business looking for vehicle financing, Free2Move Lease, our business finance specialists, can deliver exactly what you need.

Free2Move Lease is one of the UK's largest leasing companies and is also a member of the British Vehicle Rental and Leasing Association (BVRLA).

With over 60,000 vehicles in the Free2Move Lease portfolio, Free2Move Lease is able to offer competitive vehicle solutions. In addition, Free2Move Lease also offer innovative connected management of servicing and maintenance.

For further information, please contact your local Vauxhall Retailer or visit www.vauxhall.co.uk/offers-finance/business-leasing.html

Vehicle Excise Duty

The amount of Vehicle Excise Duty (road fund licence) payable on new cars varies depending on the level of carbon dioxide (CO₂) emissions produced by the vehicle. CO₂ emissions are measured in grams per kilometre (g/km) travelled and divided into 13 charging bands shown in the table opposite.

A 'first year rate' of Vehicle Excise Duty is payable on all new cars and in subsequent years the amount payable reverts to the 'standard rate'. From 1 April 2017 the breakpoints for each of these bands have been revised. Also, for vehicles with a list price over £40,000, including factory-fitted options, an additional £320 is payable for the first five years of standard rate payments.

Vehicle Excise Duty*

Band	CO ₂ emissions in grams per kilometre	First year rate		Standard rate
		Petrol [#]	Diesel [†]	
A	0	£0	£0	£0
B	1-50	£10	£25	£145
C	51-75	£25	£110	£145
D	76-90	£110	£135	£145
E	91-100	£135	£155	£145
F	101-110	£155	£175	£145
G	111-130	£175	£215	£145
H	131-150	£215	£540	£145
I	151-170	£540	£870	£145
J	171-190	£870	£1,305	£145
K	191-225	£1,305	£1,850	£145
L	226-255	£1,850	£2,175	£145
M	Over 255	£2,175	£2,175	£145

*Correct at time of issue.

[#]Also applies to diesel vehicles that meet the Real Driving Emissions Step 2 (RDE2).

[†]Applies to vehicles that do not meet the Real Driving Emissions Step 2 (RDE2).

FURTHER INFORMATION

Customer Care Commitment

For added peace of mind, Vauxhall has an innovative Customer Care Commitment that offers the following:

- Three-year vehicle warranty consisting of a one-year/unlimited mileage manufacturer's warranty and a second and third year manufacturer's warranty with a 60,000 miles limitation
- Vauxhall Assistance for 12 months from first registration
- Six years' body panel anti-perforation warranty

Please note: Warranty is only available on vehicles sourced from Vauxhall Motors Limited. Terms and conditions apply – please see your Vauxhall Retailer for details.

Vauxhall Assistance

Vauxhall Assistance is provided automatically with every new Vauxhall for 12 months from first registration and covers everything from accident assistance, roadside recovery and 'at home' service to flat tyres. With Vauxhall Assistance help is literally just a free* phone call away, 24 hours a day, 365 days a year!

Protecting the environment

Vauxhall's commitment to the environment is demonstrated by our products' many environmental awards. For even more information on Vauxhall's efforts to achieve an environmentally sustainable future, and how to dispose of your end-of-life vehicle, see www.vauxhall.co.uk/recycling

Vauxhall Care

This all-inclusive service package is available on Vauxhalls under 10 months old (from date of first registration).

This package offers complete peace of mind for the first 3 years of your Vauxhall's life with fixed monthly payments for the plan duration.

- **3 years' Vauxhall servicing** – covers first, second and third annual services. Including a brake-fluid change in the second service
- **2 years' Vauxhall Roadside Assistance** – first year from us
- **First years' MOT**** – free of charge by your local Vauxhall Retailer

For full terms and conditions and to sign up, visit: vauxhall.co.uk/vauxhallcare

Vauxhall Service Club

Vauxhall Service Club is available for all Vauxhall owners, and it's free to join. Members benefit from the following:

- 15% off Vauxhall Approved Accessories
- Vauxhall's aged 2-3 Years = 15% off parts and labour
- Vauxhall's aged over 3 Years = 25% off parts and labour
- Half price MOT's (NI excluded)
- Free pre-MOT test inspection (NI only)
- Fixed price AdBlue Refills
 - Car = £14.99
 - Van = £24.99
- Access to the Vauxhall Accident Management Programme
- Online service booking available 24/7 with servicing appointments available within 3 days – [Book Online](#)
- Collection and delivery/onward mobility options
- Complimentary 'Wash and Vac' with all routine services[†]
- Vauxhall trained technicians
- Genuine Vauxhall parts
- Minimum 12 months warranty on parts and labour
- Regular newsletters with exclusive offers, discounts and competitions

Terms and conditions apply. To join visit: vauxhall.co.uk/serviceclub

Vauxhall Insurance with added reassurance

Comprehensive cover – Summary of benefits

- Competitive premiums
- Repairs by a Vauxhall-trained technician
- Genuine Vauxhall parts, guaranteed for five years when we repair your car within our Approved Repairer Network
- Free courtesy car as standard when using an Approved Repairer^{††}
- 24 hour claims helpline
- Personal Accident benefit
- Cover for audio equipment
- Windscreen cover

Call for a quote on **0330 678 1130**[‡]

For more product information

For further information on the Vauxhall range or location of your nearest Vauxhall Retailer please call **0345 600 1500**. Alternatively, details can be found on our website at vauxhall.co.uk

*Mobile phone users will be charged at their standard tariff.

**First years' MOT is not available for Northern Ireland.

[†]Participating Retailers only.

^{††}Should your car need repairing following an accident we provide a courtesy car (subject to availability) for the duration of the repair. Only genuine Vauxhall parts are used. Terms and conditions apply.

[‡]Calls may be recorded. Vauxhall Insurance Services is a trading name of Europa Group Limited which is authorised and regulated by the Financial Conduct Authority. Europa Group Limited's Financial Services Register number 309794. Registered as a limited company in England and Wales No 03279177. Registered Office: Europa House, Midland Way, Thornbury, Bristol, BS35 2JX.

Take the next step:



Join us online:

Discover the full Vauxhall range at [vauxhall.co.uk](https://www.vauxhall.co.uk) >

Privacy Policy: For full details please visit [vauxhall.co.uk/privacy](https://www.vauxhall.co.uk/privacy)

The invoice price, including delivery to Retailer, factory-fitted options, accessories fitted by the Retailer and number plates, is subject to VAT. Some feature descriptions in this guide may refer to, and some illustrations may show, optional equipment not included in the standard delivery. The information contained in this guide was accurate at the time of publication. We reserve the right to make changes in design and equipment. Please note that Vauxhall Retailers are not the agents of Vauxhall Motors Limited and are not authorised to bind Vauxhall Motors Limited by any specific or implied undertaking or representation. It is advisable to ensure that your motor insurance policy provides adequate cover for additional fitted options and accessories. The colours in this guide are only approximate actual colours. Illustrated optional equipment is available at extra charge. Availability, technical features and equipment provided on our vehicles can vary by model. For precise information on the equipment provided on our vehicles, please contact your local Vauxhall Retailer.

NEW INSIGNIA

Price and Specification Guide | 4 March 2020 | Model Year 2021



Range Highlights

Models

Prices

Features/Options

Interior Style and Comfort

Infotainment

Exterior Colours

Wheels and Tyres

Engines and Technical Data

Performance, Economy and Emissions

Specifications

Dimensions and Capacities

Accessories

Company Car Information

Further Information

NEW INSIGNIA RANGE HIGHLIGHTS

SE NAV

Standard features include:

- Multimedia Navi infotainment system
 - Fully integrated sat nav system
 - 7-inch colour touchscreen
 - AM/FM/DAB digital radio
 - Bluetooth® audio streaming
 - Bluetooth® mobile phone portal
 - Apple CarPlay™/Android Auto™
 - Twin front USB sockets and aux in
- Seven speakers (five front, two rear)
- Ergonomic active driver's seat (AGR-approved*)
- Dual zone electronic climate control
- Multi-function trip computer
- Cruise control with intelligent speed limiter
- Front and rear parking sensors
- Leather-covered steering wheel
- Front centre armrest
- Steering wheel audio/phone/cruise controls
- Steering column adjustable for reach/rake
- LED headlights and tail lights
- LED daytime running lights
- 17-inch silver, five twin-spoke alloy wheels
- Storage pockets on front seat backs
- Electrically operated front/rear windows
- Electrically adjustable/heated door mirrors
- 60/40 split-folding rear seat back
- Automatic emergency braking with pedestrian detection
- Forward collision alert
- Following distance indicator
- Lane departure warning with lane assist
- Electronic Stability Programme (ESP)
- Anti-lock Braking System (ABS)
- Six airbags • Hill start assist
- ISOFIX child seat mounting points, outer rear seats
- Tyre pressure monitoring system
- Remote control central locking
- Security alarm system
- Rain-sensitive windscreen wipers
- Auto-dimming rear-view mirror
- Automatic lighting control with tunnel detection
- High beam assist • Front fog lights
- Traffic sign recognition
- 3.5-inch monochrome information display

SRI NAV

Features over SE Nav models:

- Illuminated vanity mirrors
- LED ambient lighting
- Rear spoiler
- Gloss black lower side window trim
- Chrome-effect upper window trim
- Premium leather-effect side bolsters

SRI VX-LINE NAV

Features over SRI Nav models:

- Multimedia Navi Pro infotainment system
 - 8-inch colour touchscreen
 - On-board voice control
- IntelliLux LED® Pixel headlights with anti-glare high beam
- Leather seat facings
- Dark-tinted rear windows
- 20-inch bi-colour high gloss black, five twin-spoke alloy wheels
- Keyless entry and start
- Twin rear USB sockets
- FlexFold 40/20/40 split-folding rear seat back with one-touch release
- Wireless charger
- Sports-style front and rear bumpers
- Jet black headlining
- Alloy sports pedals
- VX-Line, heated, flat bottomed leather steering wheel
- 8-inch colour information display
- Shark fin aerial
- Ergonomic active front seats (AGR-approved*)
- Heated front seats
- Driver's seat massage functions

ULTIMATE NAV

Features over SE Nav models:

- Multimedia Navi Pro infotainment system
 - 8-inch colour touchscreen
 - On-board voice control
- IntelliLux LED® Pixel headlights with anti-glare high beam
- Heated front and outer rear seats
- Illuminated vanity mirrors
- LED ambient lighting
- Gloss black lower side window trim
- Chrome-effect upper window trim
- Door sill covers
- FlexFold 40/20/40 split-folding rear seat back with one-touch release
- 18-inch bi-colour high gloss black, multi-spoke alloy wheels
- Keyless entry and start
- Dark-tinted rear windows
- Electrically foldable door mirrors
- Jet black headlining
- Alloy sports pedals
- Heated, flat bottomed leather steering wheel
- 8-inch colour information display
- Shark fin aerial
- Electrically foldable door mirrors
- Ergonomic active front seats (AGR-approved*)
- Heated windscreen

GSi

Features over Ultimate Nav:

- Premium ergonomic active front seats (AGR-approved*)
- Driver's and front passenger's seat massage functions
- 20-inch bi-colour technical grey, multi-spoke diamond-cut alloy wheels
- Four-wheel drive
- Red brake calipers
- GS-Line Exterior Styling Pack
 - Sports-style front and rear bumpers
 - Side sills
 - Dual visible stainless steel exhaust tailpipes
- Leather seat facings
- Two additional rear side airbags
- FlexRide adaptive chassis
- Paddle shift
- GSi rear spoiler

Please note: GSi models do not feature front fog lights or heated windscreen.

SE NAV



VX_INS_30927

SE NAV

OTR from £23,330

Infotainment:

- Multimedia Navi system
 - Fully integrated European sat nav system
 - 7-inch colour touchscreen
 - AM/FM/DAB digital radio
 - Bluetooth® audio streaming
 - Bluetooth® mobile phone portal
 - Apple CarPlay™/Android Auto™
 - Twin front USB sockets and aux in
- Seven speakers (five front, two rear)

Interior convenience/styling:

- Ergonomic active driver's seat (AGR-approved*)
- Dual-zone electronic climate control
- Multi-function trip computer
- Cruise control with intelligent speed limiter
- Leather-covered steering wheel
- Front centre armrest
- Steering wheel audio/phone/cruise controls
- Steering column adjustable for reach/rake
- 3.5-inch monochrome information display
- 60/40 split-folding rear seat back

Exterior convenience/styling:

- 17-inch five twin-spoke alloy wheels
- Electrically operated front/rear windows
- Electrically adjustable/heated door mirrors
- Front and rear parking sensors
- LED headlights and tail lights
- Front fog lights
- Ambient LED lighting
- Sight and Light pack
 - Rain sensitive windscreen wipers
 - Auto-dimming rear-view mirror
 - Automatic lighting control with tunnel detection
 - High beam assist

Safety/security:

- Driving Assistance Pack
 - Automatic emergency braking with pedestrian detection
 - Forward collision alert
 - Following distance indicator
 - Lane departure warning with lane assist
- Electronic Stability Programme (ESP)
- Anti-lock Braking System (ABS)
- Six airbags
- Hill start assist
- ISOFIX child seat mounting points, outer rear seats
- Tyre pressure monitoring system
- LED daytime running lights
- Remote control central locking
- Security alarm system
- Traffic sign recognition
- Tyre inflation kit

*AGR (The Campaign for Healthier Backs) is an independent centre of excellence for ergonomics, based in Germany.

SRI NAV



VX_INS_30928

SRI NAV

OTR from £24,830

Infotainment:

- Multimedia Navi system
 - Fully integrated European sat nav system
 - 7-inch colour touchscreen
 - AM/FM/DAB digital radio
 - Bluetooth® audio streaming
 - Bluetooth® mobile phone portal
 - Apple CarPlay™/Android Auto™
 - Twin front USB sockets and aux in
- Seven speakers (five front, two rear)

Interior convenience/styling:

- Ergonomic active driver's seat (AGR-approved*)
- Dual-zone electronic climate control
- Multi-function trip computer
- Cruise control with intelligent speed limiter
- Leather-covered steering wheel
- Front centre armrest
- Steering wheel audio/phone/cruise controls
- Steering column adjustable for reach/rake
- Illuminated vanity mirrors
- Storage pockets on front seat backs
- LED ambient lighting
- 3.5-inch monochrome information display
- 60/40 split-folding rear seat back

Exterior convenience/styling:

- 17-inch five twin-spoke alloy wheels
- Front fog lights
- Gloss black side window trim
- Chrome-effect upper window trim
- Electrically operated front/rear windows
- Electrically adjustable/heated door mirrors
- Rear spoiler
- Front and rear parking sensors
- LED headlights and tail lights
- Sight and Light pack
 - Rain sensitive windscreen wipers
 - Auto-dimming rear-view mirror
 - Automatic lighting control with tunnel detection
 - High beam assist

Safety/security:

- Driving Assistance Pack
 - Automatic emergency braking with pedestrian detection
 - Forward collision alert
 - Following distance indicator
 - Lane departure warning with lane assist
- Electronic Stability Programme (ESP)
- Anti-lock Braking System (ABS)
- Six airbags
- Hill start assist
- ISOFIX child seat mounting points, outer rear seats
- Tyre pressure monitoring system
- LED daytime running lights
- Remote control central locking
- Security alarm system
- Traffic sign recognition
- Tyre inflation kit

*AGR (The Campaign for Healthier Backs) is an independent centre of excellence for ergonomics, based in Germany.

SRI VX-LINE NAV



VX_INS_30929

SRI VX-LINE NAV

OTR from
£27,830

Infotainment:

- Multimedia Navi Pro system
 - Fully integrated European sat nav system
 - 8-inch colour touchscreen
 - AM/FM/DAB digital radio
 - Bluetooth® audio streaming
 - Bluetooth® mobile phone portal
 - Apple CarPlay™/Android Auto™
 - Twin front USB sockets and aux in
- Seven speakers (five front, two rear)

Interior convenience/styling:

- Perforated leather seat facings
- Ergonomic active front seats (AGR-approved*)
- Dual-zone electronic climate control
- Heated front seats
- Multi-function trip computer
- Cruise control with intelligent speed limiter
- Steering wheel audio/phone/cruise controls
- Steering column adjustable for reach/rake
- Twin rear USB sockets
- Auto-dimming rear-view mirror
- Illuminated vanity mirrors
- LED ambient lighting
- Wireless charger
- 8-inch colour information display
- FlexFold 40/20/40 split-folding rear seat back with one-touch release
- Jet black headliner
- Alloy sports pedals
- VX-Line, heated, flat bottomed leather steering wheel
- Driver's seat massage functions

Exterior convenience/styling:

- 20-inch bi-colour high gloss black, five twin-spoke alloy wheels

- Sports-style front and rear bumpers
- Rear spoiler
- Gloss black side window trim
- Chrome-effect upper window trim
- Electrically operated front/rear windows
- Dark-tinted rear windows
- Front and rear parking sensors
- IntelliLux LED® Pixel headlights with anti-glare high beam
- LED tail lights
- Sight and Light pack
 - Rain sensitive windscreen wipers
 - Auto-dimming rear-view mirror
 - Automatic lighting control with tunnel detection
 - High beam assist
- Illuminated vanity mirrors
- Front fog lights
- Electrically adjustable/heated door mirrors
- Shark fin aerial

Safety/security:

- Driving Assistance Pack
 - Automatic emergency braking with pedestrian detection
 - Forward collision alert
 - Following distance indicator
 - Lane departure warning with lane assist
- Electronic Stability Programme (ESP)
- Anti-lock Braking System (ABS)
- Six airbags
- ISOFIX child seat mounting points, outer rear seats
- Tyre pressure monitoring system
- LED daytime running lights
- Keyless entry and start
- Security alarm system
- Traffic sign recognition
- Tyre inflation kit

*AGR (The Campaign for Healthier Backs) is an independent centre of excellence for ergonomics, based in Germany.

ULTIMATE NAV



VX_INS_30930

ULTIMATE NAV

OTR from
£27,830

Infotainment:

- Multimedia Navi Pro system
 - Fully integrated European sat nav system
 - 8-inch colour touchscreen
 - AM/FM/DAB digital radio
 - Bluetooth® audio streaming
 - Bluetooth® mobile phone portal
 - Apple CarPlay™/Android Auto™
 - Twin front USB sockets and aux in
- Seven speakers (five front, two rear)

Interior convenience/styling:

- Ergonomic active front seats (AGR-approved*)
- Dual-zone electronic climate control
- Multi-function trip computer
- Cruise control with intelligent speed limiter
- Front centre armrest
- Steering wheel audio/phone/cruise controls
- 8-inch colour information display
- Illuminated vanity mirrors
- LED ambient lighting
- Door sill covers
- Heated windscreen
- FlexFold 40/20/40 split-folding rear seat back with one-touch release
- Jet black headliner
- Alloy sports pedals
- Heated, flat bottomed leather steering wheel
- Heated front and outer rear seats

Exterior convenience/styling:

- 18-inch bi-colour high gloss black, multi-spoke diamond-cut alloy wheels

- Front fog lights
- Gloss black side window trim
- Chrome-effect upper window trim
- Dark-tinted rear windows
- Front and rear parking sensors
- IntelliLux LED® Pixel headlights with anti-glare high beam
- LED tail lights
- Sight and Light pack
 - Rain sensitive windscreen wipers
 - Auto-dimming rear-view mirror
 - Automatic lighting control with tunnel detection
 - High beam assist
- Electrically adjustable/heated and foldable door mirrors
- Shark fin aerial

Safety/security:

- Driving Assistance Pack
 - Automatic emergency braking with pedestrian detection
 - Forward collision alert
 - Following distance indicator
 - Lane departure warning with lane assist
- Electronic Stability Programme (ESP)
- Anti-lock Braking System (ABS)
- Six airbags
- Hill start assist
- ISOFIX child seat mounting points, outer rear seats
- Tyre pressure monitoring system
- Security alarm system
- Keyless entry and start
- Traffic sign recognition
- Tyre inflation kit

*AGR (The Campaign for Healthier Backs) is an independent centre of excellence for ergonomics, based in Germany.

GSi



VX_INS_30931

GSi

OTR £38,850

Infotainment:

- Multimedia Navi Pro system
 - Fully integrated European sat nav system
 - 8-inch colour touchscreen
 - AM/FM/DAB digital radio
 - Bluetooth® audio streaming
 - Bluetooth® mobile phone portal
 - Apple CarPlay™/Android Auto™
 - Twin front USB sockets and aux in
- Seven speakers (five front, two rear)

Interior convenience/styling:

- Perforated leather seat facings
- Premium ergonomic active front seats (AGR-approved*)
- Dual-zone electronic climate control
- Heated front seats
- Multi-function trip computer
- Cruise control with intelligent speed limiter
- Front centre armrest
- Steering wheel audio/phone/cruise controls
- 8-inch colour information display
- Illuminated vanity mirrors
- LED ambient lighting
- Door sill covers
- FlexFold 40/20/40 split-folding rear seat back with one-touch release
- Driver's and front passenger's seat massage functions
- Paddle shift
- Jet black headliner
- Alloy sports pedals
- Heated, flat bottomed leather steering wheel

Exterior convenience/styling:

- 20-inch bi-colour technical grey, multi-spoke alloy wheels

- GSi front and rear bumpers
- GSi side sills and rear spoiler
- Dual visible stainless steel exhaust tailpipes
- Red brake calipers
- Four-wheel drive sports chassis
- Gloss black side window trim
- Chrome-effect upper window trim
- Dark-tinted rear windows
- Front and rear parking sensors
- IntelliLux LED® Pixel headlights with anti-glare high beam
- LED tail lights
- Sight and Light pack
 - Rain sensitive windscreen wipers
 - Auto-dimming rear-view mirror
 - Automatic lighting control with tunnel detection
 - High beam assist
- Electrically adjustable/heated and foldable door mirrors
- Shark fin aerial

Safety/security:

- Driving Assistance Pack
 - Automatic emergency braking with pedestrian detection
 - Forward collision alert
 - Following distance indicator
 - Lane departure warning with lane assist
- Electronic Stability Programme (ESP)
- Anti-lock Braking System (ABS)
- Eight airbags
- Hill start assist
- Tyre pressure monitoring system
- Keyless entry and start
- Security alarm system
- Traffic sign recognition
- Tyre inflation kit
- FlexRide adaptive chassis

*AGR (The Campaign for Healthier Backs) is an independent centre of excellence for ergonomics, based in Germany.

NEW INSIGNIA PRICES

	Fuel Type	Price (£)	VAT (£)	Total (£)	On-the-road RRP (£)	Financial Year 2020/21 BiK 20% (£)	WLTP Combined CO ₂ (g/km) [#] – configured vehicle	Insurance Groups
SE NAV								
1.4 (145PS) Turbo*	Petrol	18,637.50	3,727.50	22,365.00	23,330.00	115.32	135	tba
1.4 (145PS) Turbo stepless auto*	Petrol	19,887.50	3,977.50	23,865.00	24,830.00	131.00	146	tba
1.5 (122PS) Turbo D	Diesel	19,054.17	3,810.83	22,865.00	23,790.00	106.03	121	tba
1.5 (122PS) Turbo D auto*	Diesel	20,470.83	4,094.17	24,565.00	25,320.00	tba	tba	tba
SRI NAV								
1.4 (145PS) Turbo*	Petrol	19,887.50	3,977.50	23,865.00	24,830.00	122.82	135	tba
1.4 (145PS) Turbo stepless auto*	Petrol	21,137.50	4,227.50	25,365.00	26,330.00	139.00	146	tba
1.5 (122PS) Turbo D	Diesel	20,304.17	4,060.83	24,365.00	25,290.00	112.78	121	tba
1.5 (122PS) Turbo D auto*	Diesel	21,720.83	4,344.17	26,065.00	26,820.00	tba	tba	tba
2.0 (174PS) Turbo D**	Diesel	22,470.83	4,494.17	26,965.00	27,720.00	tba	tba	tba
2.0 (174PS) Turbo D auto**	Diesel	23,887.50	4,777.50	28,665.00	29,420.00	tba	tba	tba
SRI VX-LINE NAV								
1.4 (145PS) Turbo*	Petrol	22,387.50	4,477.50	26,865.00	27,830.00	137.82	135	tba
1.4 (145PS) Turbo stepless auto*	Petrol	23,637.50	4,727.50	28,365.00	29,330.00	155.00	146	tba
2.0 (200PS) Turbo auto	Petrol	25,929.17	5,185.83	31,115.00	32,725.00	196.18	171	tba
1.5 (122PS) Turbo D	Diesel	22,804.17	4,560.83	27,365.00	28,290.00	126.28	121	tba
1.5 (122PS) Turbo D auto*	Diesel	24,220.83	4,844.17	29,065.00	29,820.00	tba	tba	tba
2.0 (174PS) Turbo D**	Diesel	24,970.83	4,994.17	29,965.00	30,720.00	tba	tba	tba
2.0 (174PS) Turbo D auto**	Diesel	26,387.50	5,277.50	31,665.00	32,420.00	tba	tba	tba
ULTIMATE NAV								
1.4 (145PS) Turbo*	Petrol	22,387.50	4,477.50	26,865.00	27,830.00	137.82	135	tba
1.4 (145PS) Turbo stepless auto*	Petrol	23,637.50	4,727.50	28,365.00	29,330.00	155.00	146	tba
2.0 (200PS) Turbo auto	Petrol	25,929.17	5,185.83	31,115.00	32,725.00	196.18	171	tba
1.5 (122PS) Turbo D	Diesel	22,804.17	4,560.83	27,365.00	28,290.00	126.28	121	tba
1.5 (122PS) Turbo D auto*	Diesel	24,220.83	4,844.17	29,065.00	29,820.00	tba	tba	tba
2.0 (174PS) Turbo D**	Diesel	24,970.83	4,994.17	29,965.00	30,720.00	tba	tba	tba
2.0 (174PS) Turbo D auto**	Diesel	26,387.50	5,277.50	31,665.00	32,420.00	tba	tba	tba
GSI								
2.0 (230PS) Turbo 4X4 auto	Petrol	30,679.17	6,135.83	36,815.00	38,850.00	231.33	193	tba

WLTP Combined CO₂ (g/km) figures, valid @ 3 March 2020, are based on a configured vehicle as per pack code for UK with no options fitted.

[#]Fuel consumption and CO₂ figures are determined according to the WLTP test cycle. CO₂ figures, BiK values and RRP pricing shown above are for a standard vehicle without any additional optional equipment. CO₂ figures are used to calculate Vehicle Excise Duty (VED) for the first registration of the vehicle and BiK. The addition of optional extras could increase the certified CO₂ emission output. This in turn may affect the amount of VED payable upon registration, and, for company car drivers, the P11D value and the amount of Benefit in Kind (BiK) tax payable. Figures shown are for comparison purposes and should only be compared to the fuel consumption and CO₂ values of other cars tested to the same technical standard. The fuel consumption achieved, and CO₂ produced, in real world conditions will depend upon a number of factors including, but not limited to: the accessories fitted (pre and post registration); variations in weather; driving styles and vehicle load. The WLTP (Worldwide Harmonised Light Vehicles Test Procedure) is used to measure fuel consumption and CO₂ figures. Full data relating to WLTP test cycles can be found at: www.vauxhall.co.uk/wltp

Please note: On-the-road recommended retail prices (RRP) include number plates and delivery to Retailer of £700.00 (inc. £116.67 VAT), 12 months' Vehicle Excise Duty and new vehicle first registration fee of £55.00. Excludes fuel and insurance. Company Car Benefit in Kind (BiK) rates are monthly based on the standard paint price. *Available late August 2020. **Available late June 2020.

SAFETY

STANDARD FEATURES – The following features are standard across the entire Insignia range.

Airbags

- Driver's airbag
- Front passenger's airbag
- Front seat side-impact airbags
- Full-size curtain airbags

Seating

- Height-adjustable front head restraints (excluding GSi models)
- Three height-adjustable rear seat head restraints

Seatbelts

- Inertia-reel lap and diagonal seatbelts
- 'Seatbelt unfastened' audible warning and warning light

Stability

- Electronic Stability Programme (ESP)
ESP monitors many different inputs to determine when the car starts to lose traction, it can then immediately respond by varying the brake pressure between up to three wheels and adjust the engine output to help correct the loss of traction and improve stability.

Additional ESP features

- Traction control
- Cornering brake control
- Straight line stability control
- Drag torque control – Maintain stability on slippery roads when lifting off the accelerator or changing gear.

Braking

- Automatic emergency city braking
- Anti-lock Braking System (ABS)
- Emergency brake assist – When emergency braking is detected the vehicle automatically applies the maximum possible braking assistance.
- Electronic brakeforce distribution – Automatically apportions the optimum braking force to each wheel.
- Hill start assist – Briefly maintains rear brake pressure to stop the vehicle rolling back on an incline.

Tyre pressure

- Tyre pressure monitoring system

Child safety

- Deactivation switch for front passenger's front and side-impact airbags
- ISOFIX child seat mountings incorporating top tether anchor points located on outer rear seats (does not include child seat) – Allows ISOFIX child safety seats to be securely fixed into the car. The ISOFIX mounting system reduces forward movement in an accident and makes the child seat easier to install.
- Child-proof locks on rear doors

Pedestrian safety

- Active bonnet/headlight/wiper structure – Designed to reduce pedestrian head and upper body injuries. The active bonnet travels backwards and upwards to help prevent impact between pedestrian's head and underbonnet components.
- Upper and lower bumper design – Reduces upper and lower leg injuries.

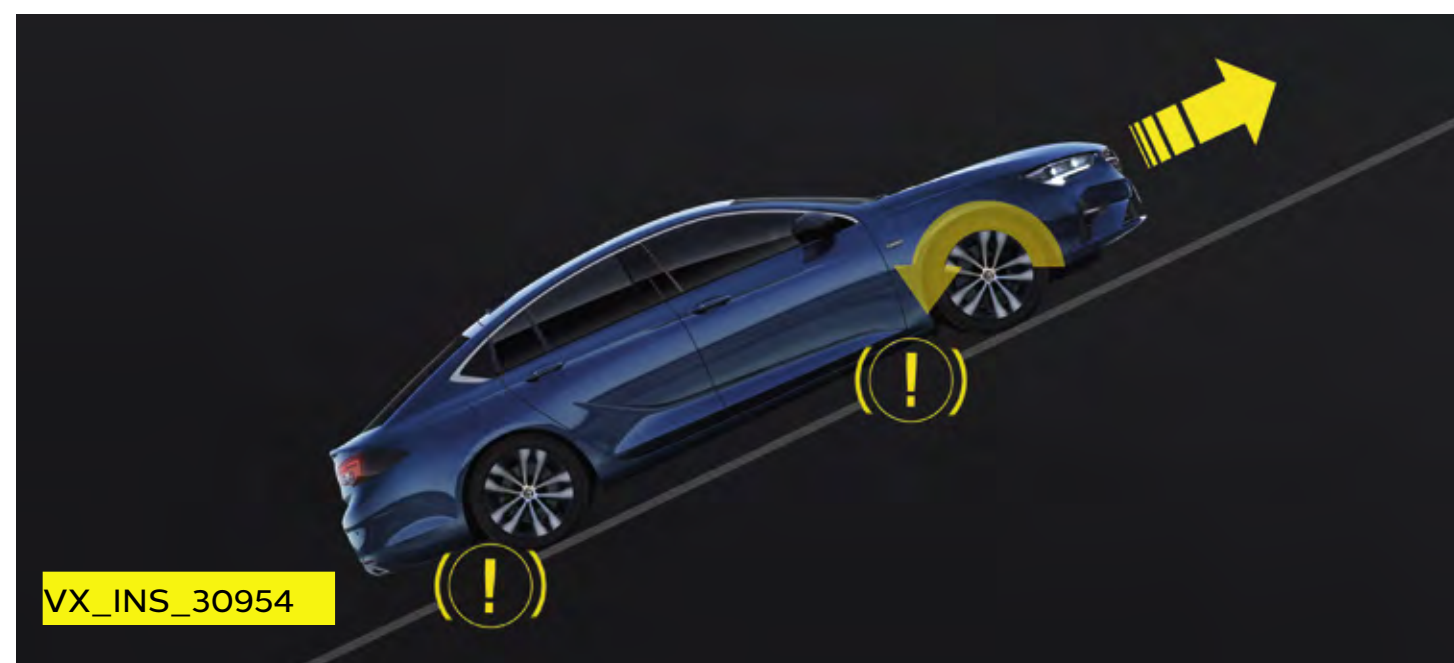

Hill start assist.



ISOFIX child seat mountings.



Automatic emergency braking.

DRIVER ASSISTANCE

STANDARD FEATURES – The following features are standard across the entire Insignia range. Specific features by Model are outlined in the separate tabular information

Cruise control with speed limiter

With steering wheel mounted controls. Enables you to maintain a constant speed, making it ideal for economical motorway driving.

Front camera system

A range of class-leading driver assistance and safety features are controlled by the front camera system.

Forward collision alert

Calculates the distance of vehicles ahead and pedestrians and warns the driver in case of a possible collision. The driver can choose the preferred distance.

- Visual warnings – Red LEDs projected onto windscreen and visual warning shown in the instrument cluster.
- Audible warning

Parking sensors

- Front and rear parking distance sensors

Lane departure warning with lane assist

If the driver has not actively steered or signalled, the lane departure warning system provides gentle steering correction and warns when the car moves outside of lane markings at speeds above 40mph.

- Warning light in instrument cluster
- Facia on/off switch

Automatic emergency braking with pedestrian detection

Uses either the camera or radar to detect foreign objects and pedestrians and slows down or brakes the vehicle.

Helps prevent fatal collisions at lower speeds and lets drivers drive with greater reassurance.

Traffic sign recognition

Uses the front camera to detect all types of road signs.

- Informs and reminds drivers of current speed limits, conditions and laws
- Displays country-specific signs for Europe

Following distance indicator

Indicates how many seconds you are behind the vehicle in front – Helping you maintain a safe distance.

- Timings are shown in the driver information display
- Warning light in the instrument cluster if the gap to the vehicle ahead is below that set by the driver

Electric parking brake

- Centre console switch in lieu of handbrake lever
- Premium centre console featuring adjustable armrest

Steering

- Dual pinion electrical power steering

Wipers

- Rain-sensitive windscreen wipers

Vauxhall driver assistance systems are intended to support the driver within the system-imminent limitations. The driver remains responsible for the driving task at all times.

MODEL SPECIFIC FEATURE/OPTIONS

	SE Nav	SRi Nav	SRi VX-Line Nav	Ultimate Nav	GSi
Intermittent rear window wash/wipe	No-cost option	No-cost option	No-cost option	No-cost option	No-cost option
Innovation Pack – Automatic cruise control with collision imminent braking/Head-up display				£2000	£2000
FlexRide – Enables the driver to choose from three distinct driving modes: Normal (default setting), Sport or Tour. Only available on 2.0 (200PS) Turbo and 2.0 (230PS) Turbo petrol engines.			●	●	●

DRIVER INFORMATION AND SECURITY

STANDARD FEATURES – The following features are standard across the entire Insignia range. Specific features by Model are outlined in the separate tabular information.

Driver Information

Instrumentation

- Speedometer and rev counter
- Digital fuel gauge with low fuel level warning light
- Digital water temperature gauge with warning light
- Shift-up/down indication light – Indicates when to change gear for optimum fuel economy.

Driver information display (centrally located in instrument cluster)

- Trip computer data
- Total mileage
- Service-due indicator
- Oil life
- Tyre pressure monitoring system

Multi-function trip computer (displayed on driver information display)

- Trip mileage
- Vehicle range based on remaining fuel
- Average speed
- Average fuel economy
- Instantaneous fuel economy
- Driving time

Central facia display (format dependent on infotainment unit)

- Audio information
- Digital clock with automatic RDS time adjustment
- Outside air temperature with ice warning function
- Additional features dependent on infotainment unit (see infotainment for details)

Security

- Electronically protected audio equipment
- Engine deadlock immobiliser
- Visible Vehicle Identification Number (VIN)
- Locking wheel bolts for alloy wheels
- Freewheeling door locks

Remote control central locking

- Operates on doors, tailgate and fuel filler flap
- Deadlocking
- Central locking activation switch on driver's door

Remote control ultrasonic security alarm system

- Remote control (operates in conjunction with central locking)
- Ultrasonic interior sensors
- Tilt sensor
- Independent power supply
- Thatcham approved (T1)

MODEL SPECIFIC FEATURES

	SE Nav	SRi Nav	SRi VX-Line Nav	Ultimate Nav	GSi
DRIVER INFORMATION					
Driver information display (centrally located in instrument cluster) – 3.5-inch monochrome display	●	●			
Driver information display (centrally located in instrument cluster) – 8-inch colour display incorporating speedometer and supplementary audio, phone and navigation information			●	●	●
SECURITY					
Keyless entry and start with two transmitter fobs			●	●	●

CONVENIENCE

STANDARD FEATURES – The following features are standard across the entire Insignia range. Specific features by Model are outlined in the separate tabular information.

Interior convenience

- Front 12-volt electrical accessory socket
- Driver's and front passenger's sunvisors with vanity mirrors
- Dipping rear-view mirror
- Reach and rake-adjustable steering
- Steering wheel audio/phone/cruise controls
- Automatically dimming anti-dazzle rear-view mirror

Heating and ventilation

- Dual zone electronic climate control
- Four adjustable facia vents
- Windscreen and side window demist vents

Interior storage

- Illuminated glovebox with lid
- Front door pockets with 1.5-litre bottle holder
- Two drinks holders in centre console
- Rear door pockets with 1-litre bottle holder
- Front centre adjustable armrest with 4-litre storage capacity (2.8 litres on SRi VX-Line Nav models)

Luggage area

- Luggage compartment cover
- Fully carpeted load area
- Interior tailgate handle
- Four load restraint lashing eyes
- Twin gas-assisted tailgate struts
- Storage tray in spare wheel well

Interior lighting

- Central front and rear courtesy lights
- Illuminated load area
- Twin rear reading lights
- Twin front reading lights with illuminated switches

Exterior Convenience

Door mirrors

- Twin electrically adjustable/heated door mirrors
- Manually folding door mirrors (Electrically foldable on Ultimate Nav/GSi)

Windows

- Electrically operated front and rear windows with safety autoreverse and one-touch up/down facility
- Heated rear window
- Solar heat-absorbing windscreen
- Tinted windows

MODEL SPECIFIC FEATURES

	SE Nav	SRi Nav	SRi VX-Line Nav	Ultimate Nav	GSi
INTERIOR CONVENIENCE					
Illuminated vanity mirrors		●	●	●	●
LED ambient lighting		●	●	●	●
Wireless charger for mobile devices (Maximum device dimensions 75.7 x 23.6mm) and twin rear USB sockets			●		
HEATING AND VENTILATION					
Heated steering wheel			●	●	●
Heated front seats			●	●	●
Heated rear seats				●	
Heated windscreen				●	

EXTERIOR STYLE

STANDARD FEATURES – The following features are standard across the entire Insignia range. Specific features by Model are outlined in the separate tabular information.

Exterior styling

- New front and rear bumper styling
- New front grille design
- Chrome-effect front grille bar
- Black door mirrors
- Body-colour door handles

MODEL SPECIFIC FEATURES

	SE Nav	SRI Nav	SRI VX-Line Nav	Ultimate Nav	GSi
EXTERIOR STYLING					
Gloss black lower side window trim		●	●	●	●
Chrome-effect upper side window trim		●	●	●	●
Chrome grille surround		●	●	●	
Rear spoiler		●	●		●
Dark-tinted rear windows			●	●	●
Sports-style front and rear bumpers/side sills			●		
Shark fin aerial			●	●	●
Dual decorative rear exhaust bezels (2.0 200PS Turbo/2.0 174PS Turbo D engines only)		●	●	●	
Door sill covers				●	●
GSi front/rear bumpers/side sills/satin chrome grille surround					●
Dual visible stainless steel exhaust tailpipes					●

EXTERIOR LIGHTING

STANDARD FEATURES – The following features are standard across the entire Insignia range. Specific features by Model are outlined in the separate tabular information.

Exterior lighting

- LED daytime running lights
- LED tail lights
- LED side repeat indicators
- Automatic lighting control with tunnel detection: When the automatic lighting control is switched on, the system switches between daytime running lights and headlights automatically depending on external lighting conditions.
- Lights-on audible warning: When driver's door is opened an audible warning sounds to alert the lights have been left on.
- Manual headlight beam levelling: Use to adapt headlight range to the vehicle load to prevent dazzling.
- High beam assist
- LED brake lights
- High-level LED centre rear brake light
- Rear fog light
- Reversing light
- Hazard warning lights
- Door-to-door illumination: Headlights illuminate the area for an adjustable time after leaving the vehicle.
- Welcome lighting: Headlights and tail lights illuminate when the vehicle is unlocked.

MODEL SPECIFIC FEATURES

	SE Nav	SRi Nav	SRi VX-Line Nav	Ultimate Nav	GSi
EXTERIOR LIGHTING					
Front fog lights	●	●	●	●	
LED headlights	●	●			
IntelliLux LED® Pixel headlights with anti-glare high beam			●	●	●



VX_INS_30963

LED headlight.



VX_INS_30964

IntelliLux LED Pixel headlight.



VX_INS_30965

LED tail lights.

INTERIOR STYLING AND COMFORT

SE NAV MODELS



Steering wheel:

- Three-spoke design
- Leather-covered
- Satin chrome-effect bezel

Facia and door trim:

- Black facia
- Black door panels with black Atlantis cloth inserts
- Parallax trim inserts
- Chrome-effect interior door handles

Seating:

- Ergonomic active driver's seat (AGR-approved*)

- Driver's seat (eight-way adjustable):
 - Height – Reach – Backrest
 - Seat cushion extension
 - Lumbar adjustment (four-way electrical)
 - Head restraint (four-way)

- Front passenger's seat (four-way adjustable):
 - Reach – Backrest
 - Head restraint (four-way)
- 60/40 split-folding rear seat back

Seat trim:

- Billy jet black cloth seat trim inserts
- Jet black fabric side bolsters

SRI NAV MODELS



Steering wheel:

- Three-spoke design
- Leather-covered
- Satin chrome-effect bezel

Facia and door trim:

- Black facia
- Black door panels with black premium leather-effect inserts
- Dark metallic Hexagon trim inserts
- Chrome-effect interior door handles

Seating:

- Ergonomic active driver's seat (AGR-approved*)

- Driver's seat (eight-way adjustable):
 - Height – Reach – Tilt – Backrest
 - Seat cushion extension
 - Lumbar adjustment (four-way electrical)
 - Head restraint (four-way)

- Front passenger's seat (four-way adjustable):
 - Reach – Backrest
 - Head restraint (four way)
- 60/40 split-folding rear seat back

Seat trim:

- Monita marvel black fabric seat trim inserts
- Jet black premium leather-effect side bolsters

INTERIOR STYLING AND COMFORT

SRI VX-LINE NAV MODELS



Steering wheel:

- Three-spoke design
- VX-Line, heated, flat bottomed, leather-covered steering wheel
- Satin chrome-effect bezel

Facia and door trim:

- Black facia
- Black door panels with black premium leather-effect inserts
- Dark metallic Hexagon trim inserts
- Chrome-effect interior door handles

Pedals:

- Sports, alloy-effect

Seating:

- Ergonomic active front seats (AGR-approved*)
- Driver's seat (eight-way adjustable):
 - Height (electrical) - Reach (electrical)
 - Tilt (electrical) - Backrest (electrical)
 - Seat cushion extension
 - Lumbar adjustment (four-way electrical)
 - Head restraint (four-way)
 - Active ventilation
 - Pneumatically adjustable backrest side bolsters
 - Massage functions
 - Seat memory function, including door mirrors
- Front passenger's seat (eight-way adjustable):
 - Height - Reach - Tilt - Backrest
 - Seat cushion extension
 - Lumbar adjustment (four-way electrical)
 - Head restraint (four-way)
- Heated front seats
- FlexFold 40/20/40 split-folding rear seat back with one-touch release

Seat trim:

- Black Sienna perforated leather seat trim inserts
- Black premium leather-effect side bolsters

VX_INS_30934

INTERIOR STYLING AND COMFORT

ULTIMATE NAV MODELS



Steering wheel:

- Three-spoke design
- Heated, flat bottomed, leather-covered steering wheel
- Satin chrome-effect bezel

Facia and door trim:

- Black facia
- Black door panels with black leather-effect inserts
- Brushed ice trim inserts

Pedals:

- Sports, alloy-effect

Seating:

- Ergonomic active sports front seats (AGR-approved*)
- Driver's and front passenger's seat (eight-way adjustable):
 - Height
 - Reach
 - Tilt
 - Backrest
 - Seat cushion extension
 - Lumbar adjustment (four-way electrical)
 - Head restraint (four-way)
- Heated front seats and outer rear seats
- FlexFold 40/20/40 split-folding rear seat back with one-touch release

Seat trim:

- Black Alcantara seat trim inserts
- Black premium leather effect side bolsters

VX_INS_30935

*AGR (The Campaign for Healthier Backs) is an independent centre of excellence for ergonomics, based in Germany.

INTERIOR STYLING AND COMFORT

GSi MODELS



Steering wheel:

- Heated, flat bottomed, leather-covered steering wheel
- Satin chrome-effect bezel
- Paddle shift

Facia and door trim:

- Black facia
- Black door panels with black leather-effect inserts
- Brushed ice trim inserts

Pedals:

- Sports, alloy-effect

Seating:

- Premium ergonomic active sports front seats (AGR-approved*)
- Driver's and front passenger's seat (eight-way adjustable):
 - Height (electrical)
 - Reach (electrical)
 - Tilt (electrical)
 - Backrest (electrical)
 - Seat cushion extension
 - Lumbar adjustment (four-way electrical)
 - Massage functions
 - Active ventilation
 - Pneumatically adjustable backrest side bolsters
 - Driver's seat memory function, including door mirrors
 - Heated front and outer rear seats
 - FlexFold 40/20/40 split-folding rear seat back

Seat trim:

- Black Siena perforated leather seat trim inserts
- Black premium leather-effect side bolsters

VX_INS_30936

*AGR (The Campaign for Healthier Backs) is an independent centre of excellence for ergonomics, based in Germany.

INFOTAINMENT

STANDARD FEATURES

MULTIMEDIA NAVI WITH 7-INCH TOUCHSCREEN

STANDARD ON SE NAV AND SRi NAV

Onboard features:

- 7-inch colour touchscreen
- DAB Digital radio
- RDS with Traffic Programme
- AM/FM stereo radio with 36 station presets
- Seven speakers
- 20 watts per channel output

Media connections:

- Twin front USB sockets and aux in
- Bluetooth® A2DP audio streaming (Advanced Audio Distribution Profile)

Mobile phone portal:

- Bluetooth® connectivity
- Vehicle microphone
- Handsfree calls via steering wheel controls
- Phone book access – Contacts/last calls/missed calls etc. are mirrored on the display and are easily navigated using the touchscreen (features dependent on mobile phone).

Smartphone interface:

- Apple CarPlay™ • Android Auto™
- Smartphone projection that allows operations via voice command, touchscreen and buttons to control apps and music playback

Navigation features:

- Satellite navigation system
- 2D/3D street level mapping
- European coverage
- Points-of-interest search
- Map updates via USB



VX_INS_30951

7-inch colour touchscreen.



VX_INS_30950

Smartphone projection.

INFOTAINMENT

STANDARD FEATURES

MULTIMEDIA NAVI PRO WITH 8-INCH TOUCHSCREEN

STANDARD ON SRI VX-LINE NAV, ULTIMATE NAV AND GSi MODELS

Features as Multimedia Navi, with the addition of the following features:

- 8-inch colour touchscreen
- 8-inch digital colour instrument display
- SD card slot
- Personalised profiles
- Shark fin aerial



8-inch colour touchscreen and digital information display.

OPTIONAL FEATURES

e-CALL

The optional e-Call system exclusive to Vauxhall can be specified for Insignia orders, automatically sending an emergency call if the seatbelt tensioners or airbags are deployed. Alternatively emergency help can be summoned by pressing the red e-Call button. Optional on all models at £490 including VAT.



e-Call button.

EXTERIOR COLOURS

Carbon Brown (G1S)*
Two-coat metallic paint



VX_INS_30938_Carbon_Brown_G1S

Summit White (GAZ)**
Brilliant paint £360



VX_INS_30937_SummitWhite_GAZ

Sovereign Silver (GAN)**
Two-coat metallic paint £600



VX_INS_30943_Sovereign_Silver_GAN

Satin Steel Grey (GF6)†
Two-coat metallic paint £600



VX_INS_30942_Satin_Steel_Grey_GF6

Mineral Black (GB9)**
Two-coat metallic paint £600



VX_INS_30940_Mineral_Black_GB9

Navy Blue (G4B)††
Two-coat metallic paint £600



VX_INS_30941_Navy_Blue_G4B

Hot Red (G1R)**
Two-coat premium paint £710



VX_INS_30939_Hot_Red_G1R

Abalone White (GP6)**
Tri-coat premium paint £870







VX_INS_30944_Abalone_White_GP6

The colours reproduced may vary slightly from the actual paint colour. As a result they should be used as a guide only. Your Vauxhall Retailer has a comprehensive display of our paint samples.

*Standard exterior paint. Not available on GSi models. **Optional at extra cost. †Optional at extra cost. Standard on GSi models. ††Optional at extra cost. Not available on GSi models.

WHEELS AND TYRES

		SE Nav	SRi Nav	SRi VX-Line Nav	Ultimate Nav	GSi
 <p>17-inch silver five-twinspoke alloy wheels</p> <ul style="list-style-type: none"> • 215/55 R 17 tyres. • Emergency tyre inflation kit (in lieu of spare wheel) 		●	●			
 <p>20-inch bi-colour high gloss black, five twin-spoke diamond-cut alloy wheels</p> <ul style="list-style-type: none"> • 245/45 R 20 tyres. • Emergency tyre inflation kit (in lieu of spare wheel) 				●		
 <p>18-inch bi-colour high gloss black, multi-spoke diamond-cut alloy wheels</p> <ul style="list-style-type: none"> • 245/55 R 18 tyres. • Emergency tyre inflation kit (in lieu of spare wheel) 					●	
 <p>20-inch bi-colour technical grey, multi-spoke diamond-cut alloy wheels</p> <ul style="list-style-type: none"> • 245/35 R 20 tyres. • Emergency tyre inflation kit (in lieu of spare wheel) 						●
	Steel emergency spare wheel offer 16-inch 1.4 (145PS) Turbo/ 1.5 (122PS) Turbo D manual	£160	£160			
	Steel emergency spare wheel offer 17-inch 1.5 (122PS) Turbo D auto/ 2.0 (174PS) Turbo D/2.0 (200PS) Turbo	£160	£160		£160	

PETROL ENGINES

	1.4 (145PS) Turbo*	2.0 (200PS) Turbo	2.0 (230PS) Turbo
Capacity	1342cc	1998cc	1998cc
Maximum power	145PS (107kW) @ 5000-6000rpm	200PS (149kW) @ 4000-5500rpm	230PS (169kW) @ 5000rpm
Maximum torque	236Nm (174 lb.ft.) @ 1500-3500rpm	350 Nm (258 lb.ft.) @ 1500-4000rpm	350 Nm (258 lb.ft.) @ 1500-4000rpm
Configuration	3 cylinders, 4 valves per cylinder, double overhead camshafts	4 cylinders, 4 valves per cylinder, double overhead camshafts	4 cylinders, 4 valves per cylinder, double overhead camshafts
Fuel/induction system	Turbocharger. Variable Valve Timing (VVT). Spark ignited direct injection (SIDI)	Twin scroll turbocharger. Variable camshaft control. Spark ignited direct injection (SIDI)	Twin scroll turbocharger. Variable camshaft control. Spark ignited direct injection (SIDI)
Emission compliance	Euro 6d (6.3)	Euro 6d (6.3)	Euro 6d (6.3)
Service interval	20,000 miles or 1 year (whichever occurs sooner)	20,000 miles or 1 year (whichever occurs sooner)	20,000 miles or 1 year (whichever occurs sooner)

DIESEL ENGINES

	1.5 (122PS) Turbo D with 6-speed manual	1.5 (122PS) Turbo D with 8 speed automatic*	2.0 (174PS) Turbo D**
Capacity	1496cc	1496cc	1995cc
Maximum power	122PS (90kW) @ 3500rpm	122PS (90kW) @ 3500rpm	174PS (128kW) @ 3500rpm
Maximum torque	300Nm (221lb.ft.) @ 1750-2500rpm	285Nm (210lb.ft.) @ 1500-2750rpm	381Nm (281 lb.ft.) @ 1500-2750rpm
Configuration	3 cylinders, 4 valves per cylinder, double overhead camshafts	3 cylinders, 4 valves per cylinder, double overhead camshafts	4 cylinders, 4 valves per cylinder, double overhead camshafts
Fuel/induction system	Variable geometry turbocharger with intercooler. Common rail fuel injection	Variable geometry turbocharger with intercooler. Common rail fuel injection	Variable geometry turbocharger with intercooler. Common rail fuel injection
Emission compliance	Euro 6d (6.3)	Euro 6d (6.3)	Euro 6d (6.3)
Service interval	20,000 miles or 1 year (whichever occurs sooner)	20,000 miles or 1 year (whichever occurs sooner)	20,000 miles or 1 year (whichever occurs sooner)

All diesel models feature BlueInjection. Vehicles with BlueInjection technology will need regular AdBlue® top-ups also between servicing requirements. An indicator integrated into the on-board computer will warn you when you need to top up. More information see www.vauxhall.co.uk/adblue
In accordance with regulations R (EC) No. 715/2007 and R (EC) No. 692/2008 (in the versions respectively applicable).

*Available late August 2020. **Available late June 2020.

PERFORMANCE, FUEL ECONOMY AND EMISSIONS*

	Performance (manufacturer's figures)		Fuel economy mpg (litres/100km)#		CO ₂ emissions g/km#		Vehicle Excise Duty** 2020/21		Benefit in kind company car taxation rates – 2020/21 tax year
	Maximum speed (mph)	Acceleration 0-60mph (sec)	Combined Low	Combined High	Combined Low	Combined High	First year rate	Standard rate	
1.4 (145PS) Turbo†	tba	tba	tba	tba	135	144	tba	tba	tba
1.4 (145PS) Turbo stepless auto†	tba	tba	tba	tba	146	153	tba	tba	tba
2.0 (200PS) Turbo	tba	tba	tba	tba	171	176	tba	tba	tba
2.0 (230PS) Turbo 4X4	tba	tba	tba	tba	193	198	tba	tba	tba
1.5 (122PS) Turbo D	tba	tba	tba	tba	121	130	tba	tba	tba
1.5 (122PS) Turbo D auto†	tba	tba	tba	tba	tba	tba	tba	tba	tba
2.0 (174PS) Turbo D††	tba	tba	tba	tba	tba	tba	tba	tba	tba
2.0 (174PS) Turbo D auto††	tba	tba	tba	tba	tba	tba	tba	tba	tba

*Figures shown are for comparison purposes and should only be compared to the fuel consumption and CO₂ values of other cars tested to the same technical standard. The fuel consumption achieved, and CO₂ produced, in real world conditions will depend upon a number of factors including, but not limited to: the accessories fitted (pre and post registration); variations in weather; driving styles and vehicle load. The WLTP (Worldwide Harmonised Light Vehicles Test Procedure) is used to measure fuel consumption and CO₂ figures. The CO₂ figures display a range to reflect the highest value for the highest emitting version with all available options added, through to a minimum value to represent the lowest emitting version in standard specification.

*Provisional data. **Correct at time of publication. †Available late August 2020. ††Available late June 2020.

WEIGHTS AND TOWING DATA ^{kg}

	Gross vehicle weight	Maximum towing weights Trailer with brakes (without brakes)
1.4 (145PS) Turbo*	tba	1500 (tba)
1.4 (145PS) Turbo stepless auto*	tba	tba (tba)
2.0 (200PS) Turbo	tba	2000 (tba)
2.0 (230PS) Turbo 4X4	tba	2000 (tba)
1.5 (122PS) Turbo D	tba	1500 (tba)
1.5 (122PS) Turbo D auto*	tba	1500 (tba)
2.0 (174PS) Turbo D**	tba	1950 (tba)
2.0 (174PS) Turbo D auto**	tba	1650 (tba)

Please note: Gross vehicle weight is the total permissible weight of the vehicle including passengers and their luggage. The maximum roof rack loading should not exceed 100kg on all models. The maximum towing weights are based on the ability of the car, with two occupants of 75kg each, to restart on a 12% gradient, which is approximately 1 in 8.3, at sea level. The permitted trailer load applies up to the specified incline and up to an altitude of 1000 metres above sea level. The permissible gross train weight decreases by 10% for every 1000 metres of additional altitude. Any extra weight, such as luggage or additional passengers, should be deducted from the maximum towing weight. Always fit Vauxhall towing attachments and accessories available from your Vauxhall Retailer. They are designed specifically for Vauxhall models and carry a 12-month guarantee. During trailer towing do not exceed a maximum speed of 60mph. This speed limit is also applicable in countries with higher permitted speeds for trailer-vehicle combinations. Pay attention to the local speed limits. For trailers with low driving stability and caravans the use of an oscillation damper is strongly recommended.

*Available late August 2020. **Available late June 2020.

SPECIFICATIONS

Transmission

Six-speed manual gearbox

Petrol engines: 1.4 (145PS) Turbo

Diesel engines: 1.5 (122PS) Turbo D and 2.0 (174PS) Turbo D

Stepless automatic transmission

The stepless automatic transmission is designed to offer seamless smooth and efficient switching that maximizes fuel economy. The LuK chain along with the Long Travel Torque Converter Damper improve the overall fuel economy, optimize the minimum turbine speed and offer improved isolation. The stepless automatic transmission is available on the 1.4 (145PS) Turbo.

Eight-speed Automatic transmission

Available on 1.5 (122PS) Turbo D and 2.0 (174PS) Turbo D.

Nine-speed Automatic transmission

Available on 2.0 (200PS) Turbo and 2.0 (230PS) Turbo. The new 9-speed automatic transmission enables increased drive comfort and improved fuel economy. For extra reliability the transmission has been engineered to help reduce the amount of splash losses, hydraulic losses and the amount of torsional vibrations.

Suspension

Front: Independent. Lightweight MacPherson struts with gas-pressure dampers and coil springs. Anti-roll bar.

Rear: Lightweight multi-link (FWD – 4-link; 4X4 – 5-link) with rising-rate mini-block coil springs and gas-pressure dampers. Anti-roll bar.

- GSi models feature an updated sports chassis with lower ride height and specially tuned dampers

GSi transmission/suspension

Performance Twinster® AWD system

The GKN Performance Twinster® AWD distributes torque across the axles using a twin clutch system for a dynamic yet safe and easy-to-manage driving experience. The GKN Performance Twinster® features:

- Lightweight compact design
- Up to a 100% of the available torque can be sent to rear wheels or distributed across all four wheels according to the situation
- Electronically controlled, hydraulically actuated wet clutches
- AWD system that monitors vehicle inputs from sensors 100 times per second

FlexRide (Adaptive Stability Technology) system

FlexRide offers drivers the choice of four distinct driving modes – Normal (default setting), Sport, Tour and Competition mode.

- Sport mode: This stiffens the car's suspension and sharpens steering and throttle responses. It also raises the threshold at which the ESP and traction control systems are activated, enhancing dynamic performance
- Tour mode: Ideal for long motorway journeys, the Tour mode adjusts the dampers to a softer setting to create a perceptibly smoother ride and further enhance Insignia's ride comfort
- Continuous damping control: Utilises data from up to 11 variables including acceleration, braking and cornering to constantly control the suspension for optimum stability, driver engagement and comfort. Operates in all three driving modes

Braking and stability

- Electronic Stability Programme (ESP)
- Cornering brake control
- Straight line stability control
- Rollover mitigation
- Drag torque control
- Hill start assist
- Anti-lock Braking System (ABS)
- Emergency brake assist
- Fading brake support
- Electronic brakeforce distribution
- Adaptive brake lights

Steering

- Dual pinion electrical power steering

Fuel Tank Capacity

62 litres (13.6 gallons)

Adblue Tank Capacity

15 litres (3.3 gallons)



Performance AWD system.

DIMENSIONS AND CAPACITIES

All measurements in mm (inches) unless stated otherwise.

LOADSPACE DIMENSIONS mm (in)	
Load floor length (rear seats folded)	1940 (76.4)
Load floor length (behind rear seats)	1133 (44.6)
Load area width	1030 (40.5)
Load area height	722 (28.4)
Tailgate aperture height	557 (21.9)

LUGGAGE CAPACITIES Litres (cu.ft.)	
Rear seat up (under luggage compartment cover)	490 (17.3)
Rear seat down (measured to roof)	1450 (51.1)

*Measured using the ECIE method. When a spare wheel is specified loadspace capacity is reduced due to a raised luggage compartment floor.

All models except GSi

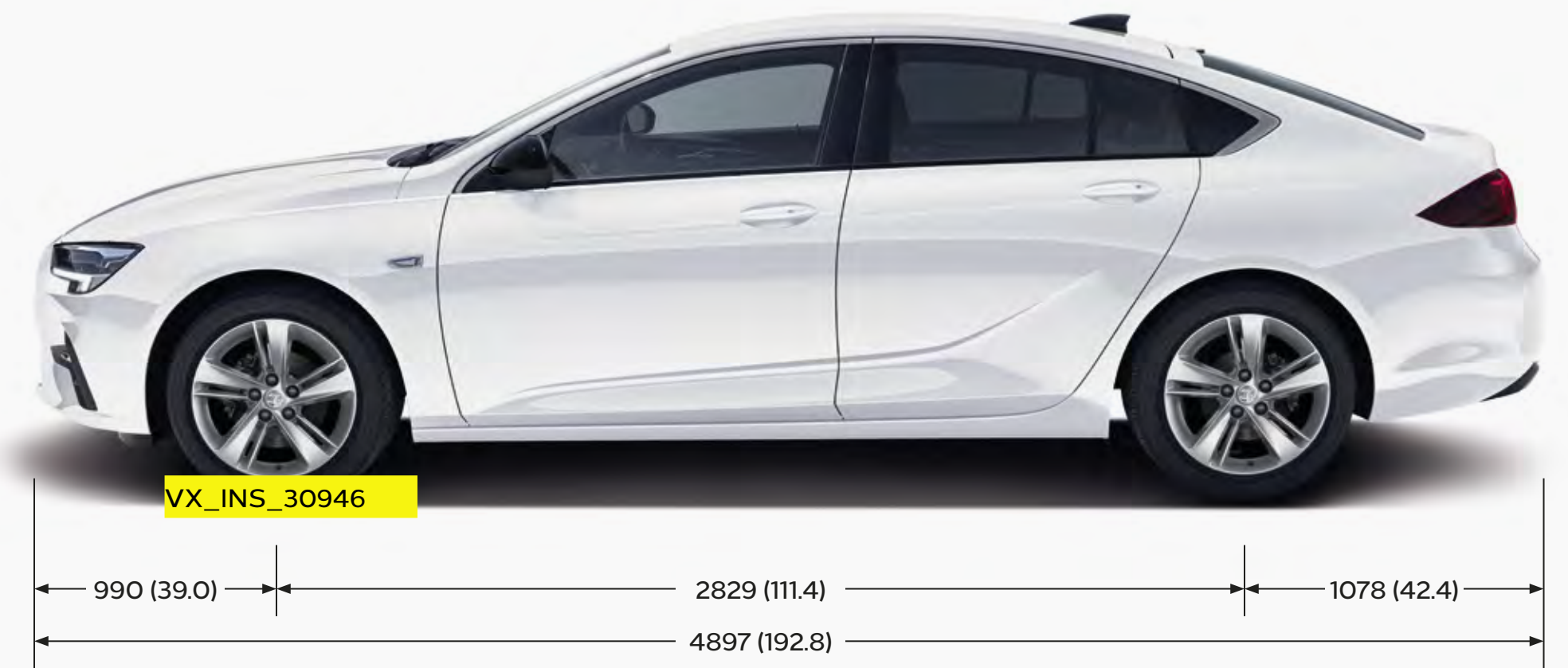

GSi

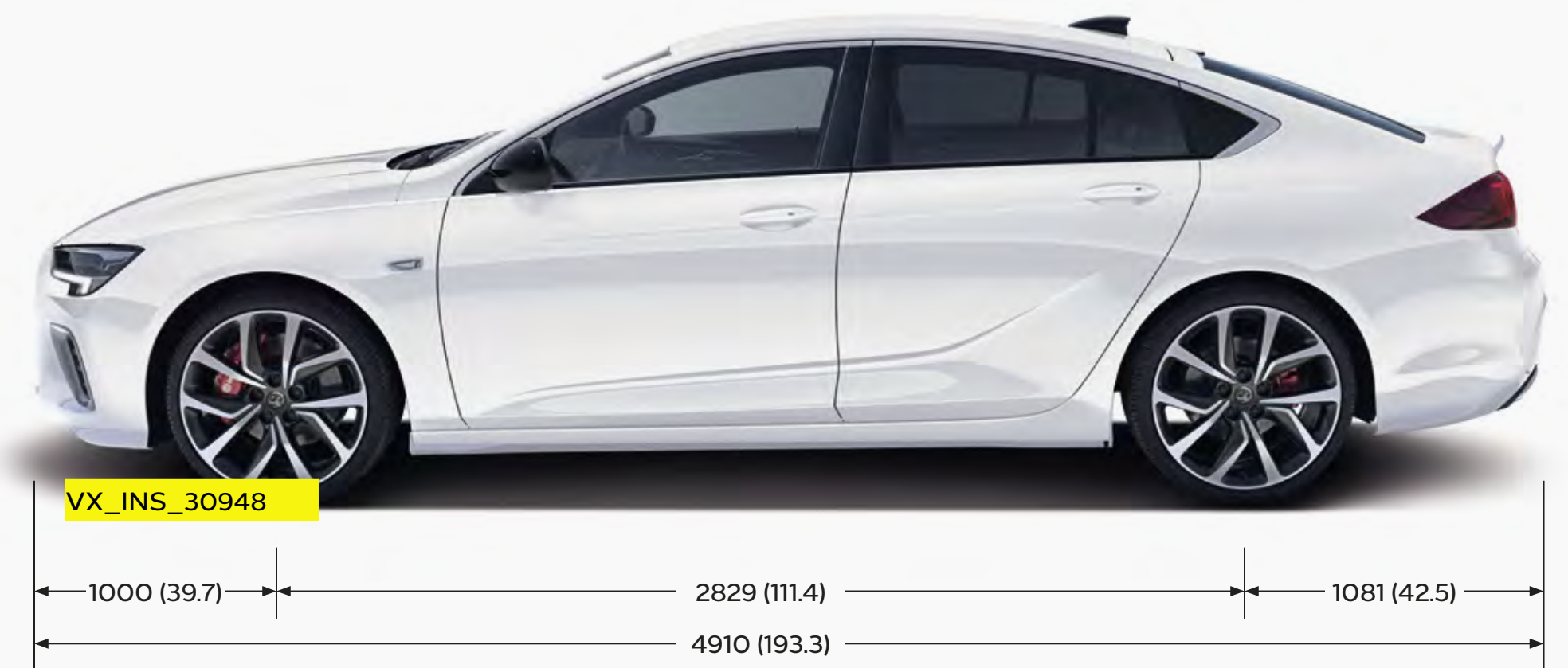

ACCESSORIES

CHILD SEATS¹ Total (inc. VAT)

BABY-SAFE ² – 0-13kg/birth to 15 months	£174
– ISOFIX base	£297
DUO ISOFIX ² – 9-18kg/9 months to 4 years	
with top tether kit	£454
KID ² – 15-36kg or 4 to 12 years	£205

INTERIOR

Cupholder insert	
– Tissue	£16
– Notepad	£16
– Make-up	£16

SAFETY

Parking sensors	
– four fully flush front bumper mounted sensors	£317
– four fully flush rear bumper mounted sensors	£353
Rear view camera	£289
Safety Pack – first aid kit, hi-visibility vest and small warning triangle	£30
Warning triangle – Small	£12
Warning triangle – Large	£20
First aid kit	£15
Hi-visibility vest	£9

PRACTICAL

Spare bulb kit ³	£41
Stretch tow rope – 3000kg	£36
Privacy Shades (rear and rear side windows)	
– Grand Sport	£94

FLEXCONNECT RANGE Total (inc. VAT)

FlexConnect bracket	£22
FlexConnect hook	£32
FlexConnect coat hanger	£34
FlexConnect folding table	£77
FlexConnect iPad Mini cradle	£109
FlexConnect iPad (1-4) cradle	£118
FlexConnect iPad Air cradle	£117
FlexConnect Samsung Galaxy cradle	£107

PROTECTION

Rubber floor mats – set of four	£51
Velour floor mats – set of four	£55
Economy floor mats – set of four	£45
Cargo liner – reversible	
– Grand Sport	£100
Cargo net – horizontal	
– Grand Sport	£46
Splash Guards	
– front	£51
– rear (Grand Sport)	£53
Door mirror caps	
– Carbon	£143
– Aluminium	£247
Bumper load protection film	
– Grand Sport	£98

TRANSPORT SYSTEMS Total (inc. VAT)

Roof base carrier	
– Grand Sport	£197
Roof carriers (requires base carrier)	
Bike roof carrier – Thule Freeride 532	£78
Bike roof carrier – Thule Expert 298	£114
Surf board roof carrier – Thule 833	£82
Kayak roof carrier – Thule 837	£172
Ski roof carrier – up to 4 pairs	
Thule 7324	£132
Ski roof carrier – up to 6 pairs	
Thule 7326	£239
Hard shell roof boxes (requires base carrier)	
Thule Ocean 80	
(320 litre/1330 x 860 x 370mm)	£154
Thule Ocean 200	
(450 litre/1750 x 820 x 450mm)	£323
Thule Motion 800	
(460 litre/2050 x 840 x 450mm)	from £463
Thule Touring 200	
(400 litre/1750 x 820 x 450mm)	£338
Thule Touring 700	
(430 litre/2320 x 700 x 420mm)	£384
Tow bar carrier system	
Fixed tow bar	£478
Detachable tow bar	£571

STYLING Total (inc. VAT)

Door sill plates	£43
Stainless steel pedal covers	
– manual	£23
– automatic	£21
Rear Spoiler Grand Sport	£266

ALLOY WHEELS (set of four with centre caps)⁴

18-inch High Gloss Black	£1,329
--------------------------	--------

Please note: Prices shown are fully fitted and painted, where applicable and include VAT. Please check with your local Vauxhall Retailer for details. It is advisable to ensure your insurance policy is adequate to cover additional fitted accessories. Prices correct at time of publication.

¹Restrictions apply to the use of child seats, please consult your Vauxhall Retailer. ²Without transponder. ³Excludes xenon headlight bulb for models with Adaptive Forward Lighting (AFL).

⁴Different tyres and locking wheel bolts/nuts may be required at extra cost. Price excludes new tyres and locking wheel bolts/nuts, includes static wheel balancing.

COMPANY CAR DRIVER AND FLEET INFORMATION

High spec, low P11D

As a business and company car driver, you'll find all of our models are seriously fit for fleet; we're talking very low P11D values, generous standard specification and high-tech engines designed for great fuel economy and low emissions – and that's just to get you started.

To get access to even more spec as standard, simply take a step up in the range – low P11D values will continue to apply.

Drivers and businesses all have unique requirements and by taking advantage of low whole-life costs and low company car driver taxation you can get in the driving seat with the spec to suit.

Company Car Driver Free 3 Day Test Drive

Our free* 3 Day Test Drive programme is open to all Company Car Drivers which allows you to choose any model in the current Vauxhall line-up (exclusions apply). With full insurance cover provided, it gives you a meaningful length of time to make an informed decision about your next company car.

Search Vauxhall 3DTD to book your FREE* test drive or click the link the below:

[Vauxhall 3 Day Test Drive](#)

*The free 3 Day Test Drive programme is open to Company Car Drivers and Fleet Decision Makers. Available for UK Mainland only. Terms and conditions apply. Full terms and conditions can be found at vauxhallfleet.co.uk/testdrive/index/terms.

Benefit in kind company car taxation**

The car benefit charge will be the car's list price (including VAT, options and accessories fitted, delivery to Retailer and number plates, but excluding Vehicle Excise Duty and new vehicle first registration fee) multiplied by the percentage charge for the CO₂ emissions band in which the car falls (see table opposite). Multiply this figure by your personal income tax rate (20%† for Basic Rate, 40%† for Higher Rate) to calculate your annual benefit in kind tax liability.

Example:

Insignia Grand Sport SE Nav 1.5 (122PS) Turbo D (CO₂ emissions 121g/km)	
On-the-road RRP	£23,790.00
Deduct: Vehicle Excise Duty	(£170.00)
New vehicle first registration fee	(£55.00)
Effective list price	£23,565.00
Add: Optional two-coat metallic paint	£600.00
List price for tax purposes (P11D value)	£24,165.00
Car benefit charge 2020-21 tax year (27%)	£6,525.00
Benefit in kind tax liability (2020-21 tax year)	
Basic Rate (20%) tax payer	£1,305.00
Higher Rate (40%) tax payer	£2,610.00

**Please note this Price Guide provides taxation information as a guide only. Vauxhall does not provide taxation guidance. Drivers should always take professional advice on their own tax position.

†Excludes residents of Scotland.

BIK FOR SCOTTISH RESIDENTS

Effective 6 April 2018 the Scottish Government have introduced their own BiK taxation structure. This only applies to Company Car Drivers that are Scottish taxpayers. HMRC will determine whether or not an individual is a Scottish taxpayer based on where their main place of residence is.

The BiK rates for Scotland are:

- Over £12,500-£14,549 Starter Rate 19%
- Over £14,549-£24,994 Basic Rate 20%
- Over £24,994-£43,430 Intermediate Rate 21%
- Over £43,430-£150,000 Higher Rate 41%
- Above £150,000 Top Rate 46%

CO ₂ emissions in grams per kilometre	Percentage of cars price to be taxed	
	Non-Diesel†† 2020-21 tax year	Diesel‡ 2020-21 tax year
Up to 50	12	-
51-54	13	-
55-59	14	-
60-64	15	-
65-69	16	-
70-74	17	-
75-79	18	22
80-84	19	23
85-89	20	24
90-94	21	25
95-99	22	26
100-104	23	27
105-109	24	28
110-114	25	29
115-119	26	30
120-124	27	31
125-129	28	32
130-134	29	33
135-139	30	34
140-144	31	35
145-149	32	36
150-154	33	37
155-159	34	37
160-164	35	37
165-169	36	37
170+	37	37

Fleet Toolbox

Discover the facts in our online Toolbox for both Company Car Drivers and Fleet Decision Makers. The Fleet Toolbox has a host of useful calculators, comparators, interactive listings and information. Search Vauxhall Fleet Tools or click the link below:

[Vauxhall Fleet Tool Box](#)

Contact Vauxhall Fleet

Please contact one of our dedicated sales teams who will be happy to help with your particular enquiry.

Company Car Drivers

Call: 0345 111 2020

Email: company-car@vauxhallinfo.co.uk

Telephone lines are open

- Monday to Friday 8:00am-9:00pm

- Saturday and Sunday 9:00am-6:00pm

Fleet Decision Makers

Depending on the size of your fleet of vehicles, we have a dedicated team to handle your enquiries. The lines are open Monday to Friday excluding Bank Holidays.

1-24 vehicles

Call: 0845 076 2254 (8:30am-5:00pm)

25+ vehicles

Call: 0330 587 8222 (8:30am-5:00pm)

Email: vauxhallfleet@vauxhall.co.uk

Special Vehicles (Police, Fire and Ambulance)

Call: 01582 409999 (8:30am-5:00pm)

Email: vauxhallspecialvehicles@vauxhall.co.uk

††Also applies to diesel vehicles that meet the Real Driving Emissions Step 2 (RDE2). ‡Applies to vehicles that do not meet the Real Driving Emissions Step 2 (RDE2).

To calculate your own personal liability, search: **Vauxhall BiK**, or click the link below:

[Vauxhall BiK Tool](#)

For more information visit www.vauxhall.co.uk/fleet

FURTHER INFORMATION

On-the-road prices

To eliminate uncertainty about hidden costs when buying a new car, Vauxhall publishes on-the-road recommended retail prices (RRP) and these are shown in the pricing tables within this price guide. These prices include VAT, number plates and delivery to Retailer of £700.00 (including £116.67 VAT), 12 months' Government Vehicle Excise Duty (see opposite for details) and the DVLA new vehicle first registration fee of £55.00.*

Please note: The on-the-road recommended retail price (RRP) does not include fuel supplied by the Retailer, motor insurance or any other goods or services supplied by agreement between the Retailer and the customer.

Price protection

Order a new Vauxhall for build in the current model year (as confirmed by your Retailer) for delivery no more than three months in advance and the price you are quoted is the price you pay. This is irrespective of any subsequent price rises between placing your order and delivery of your new car, but you must take delivery as soon as the car is available. Vauxhall Motors Limited is not liable for price adjustments caused by Government changes in the rate of VAT (currently 20%), Vehicle Excise Duty, DVLA new vehicle first registration fee or by any other applicable legislation or regulations.

In the event of an accident

Vauxhall Accident Management helps keep you mobile following an accident. Benefits include vehicle recovery, Vauxhall-approved repairs and contacting your insurer. For more details, visit www.vauxhall.co.uk/AccidentManagement

Free2Move Lease

Whether you're a big company or a small business looking for vehicle financing, Free2Move Lease, our business finance specialists, can deliver exactly what you need.

Free2Move Lease is one of the UK's largest leasing companies and is also a member of the British Vehicle Rental and Leasing Association (BVRLA).

With over 60,000 vehicles in the Free2Move Lease portfolio, Free2Move Lease is able to offer competitive vehicle solutions. In addition, Free2Move Lease also offer innovative connected management of servicing and maintenance.

For further information, please contact your local Vauxhall Retailer or visit www.vauxhall.co.uk/offers-finance/business-leasing.html

Vehicle Excise Duty

The amount of Vehicle Excise Duty (road fund licence) payable on new cars varies depending on the level of carbon dioxide (CO₂) emissions produced by the vehicle. CO₂ emissions are measured in grams per kilometre (g/km) travelled and divided into 13 charging bands shown in the table opposite.

A 'first year rate' of Vehicle Excise Duty is payable on all new cars and in subsequent years the amount payable reverts to the 'standard rate'. From 1 April 2017 the breakpoints for each of these bands have been revised. Also, for vehicles with a list price over £40,000, including factory-fitted options, an additional £320 is payable for the first five years of standard rate payments.

Vehicle Excise Duty*

Band	CO ₂ emissions in grams per kilometre	First year rate		Standard rate
		Petrol [#]	Diesel [†]	
A	0	£0	£0	£0
B	1-50	£10	£25	£145
C	51-75	£25	£110	£145
D	76-90	£110	£130	£145
E	91-100	£130	£150	£145
F	101-110	£150	£170	£145
G	111-130	£170	£210	£145
H	131-150	£210	£530	£145
I	151-170	£530	£855	£145
J	171-190	£855	£1,280	£145
K	191-225	£1,280	£1,815	£145
L	226-255	£1,815	£2,135	£145
M	over 255	£2,135	£2,135	£145

*Correct at time of issue.

[#]Also applies to diesel vehicles that meet the Real Driving Emissions Step 2 (RDE2).

[†]Applies to vehicles that do not meet the Real Driving Emissions Step 2 (RDE2).

FURTHER INFORMATION

Customer Care Commitment

For added peace of mind, Vauxhall has an innovative Customer Care Commitment that offers the following:

- Three-year vehicle warranty consisting of a one-year/unlimited mileage manufacturer's warranty and a second and third year manufacturer's warranty with a 60,000 miles limitation
- Vauxhall Assistance for 12 months from first registration
- Six years' body panel anti-perforation warranty

Please note: Warranty is only available on vehicles sourced from Vauxhall Motors Limited. Terms and conditions apply – please see your Vauxhall Retailer for details.

Vauxhall Assistance

Vauxhall Assistance is provided automatically with every new Vauxhall for 12 months from first registration and covers everything from accident assistance, roadside recovery and 'at home' service to flat tyres. With Vauxhall Assistance help is literally just a free* phone call away, 24 hours a day, 365 days a year!

Protecting the environment

Vauxhall's commitment to the environment is demonstrated by our products' many environmental awards. For even more information on Vauxhall's efforts to achieve an environmentally sustainable future, and how to dispose of your end-of-life vehicle, see www.vauxhall.co.uk/recycling

Vauxhall Care

This all-inclusive service package is available on Vauxhalls under 10 months old (from date of first registration).

This package offers complete peace of mind for the first 3 years of your Vauxhall's life with fixed monthly payments for the plan duration.

- **3 years' Vauxhall servicing** – covers first, second and third annual services. Including a brake-fluid change in the second service
- **2 years' Vauxhall Roadside Assistance** – first year from us
- **First years' MOT**** – free of charge by your local Vauxhall Retailer

For full terms and conditions and to sign up, visit: vauxhall.co.uk/vauxhallcare

Vauxhall Service Club

Vauxhall Service Club is available for all Vauxhall owners, and it's free to join. Members benefit from the following:

- 15% off Vauxhall Approved Accessories
- Vauxhall's aged 2-3 Years = 15% off parts and labour
- Vauxhall's aged over 3 Years = 25% off parts and labour
- Half price MOT's (NI excluded)
- Free pre-MOT test inspection (NI only)
- Fixed price AdBlue Refills
 - Car = £14.99
 - Van = £24.99
- Access to the Vauxhall Accident Management Programme
- Online service booking available 24/7 with servicing appointments available within 3 days – [Book Online](#)
- Collection and delivery/onward mobility options
- Complimentary 'Wash and Vac' with all routine services[†]
- Vauxhall trained technicians
- Genuine Vauxhall parts
- Minimum 12 months warranty on parts and labour
- Regular newsletters with exclusive offers, discounts and competitions

Terms and conditions apply. To join visit: vauxhall.co.uk/serviceclub

Vauxhall Insurance with added reassurance

Comprehensive cover – Summary of benefits

- Competitive premiums
- Repairs by a Vauxhall-trained technician
- Genuine Vauxhall parts, guaranteed for five years when we repair your car within our Approved Repairer Network
- Free courtesy car as standard when using an Approved Repairer^{††}
- 24 hour claims helpline
- Personal Accident benefit
- Cover for audio equipment
- Windscreen cover

Call for a quote on 0330 678 1130[‡]

For more product information

For further information on the Vauxhall range or location of your nearest Vauxhall Retailer please call **0345 600 1500**. Alternatively, details can be found on our website at vauxhall.co.uk

*Mobile phone users will be charged at their standard tariff.

**First years' MOT is not available for Northern Ireland.

[†]Participating Retailers only.

^{††}Should your car need repairing following an accident we provide a courtesy car (subject to availability) for the duration of the repair. Only genuine Vauxhall parts are used. Terms and conditions apply.

[‡]Calls may be recorded. Vauxhall Insurance Services is a trading name of Europa Group Limited which is authorised and regulated by the Financial Conduct Authority. Europa Group Limited's Financial Services Register number 309794. Registered as a limited company in England and Wales No 03279177. Registered Office: Europa House, Midland Way, Thornbury, Bristol, BS35 2JX.

TRUST VAUXHALL

Company Car Driver Free 3 Day Test Drive:

Our free* 3 Day Test Drive programme is open to all Company Car Drivers. It allows you to choose most models in the current Vauxhall line-up (exclusions apply). With full insurance cover provided, it gives you a meaningful length of time to make an informed decision about your next company car. To book your free* test drive just log on to vauxhall3dtd.co.uk or call 0330 587 8221**.

Fleet Customer Services:

Our dedicated support services for fleet decision-makers include factory demonstrators and information on whole life costs, company car taxation and finance. For further information please call 0330 587 8222

For More Product Information:

For further information on the Vauxhall range or location of your nearest Vauxhall Retailer please call 0345 600 1500.

TAKE THE NEXT STEP



JOIN US ONLINE

Discover the full Vauxhall range at vauxhall.co.uk >

*The free 3 Day Test Drive programme is open to Company Car Drivers and Fleet Decision-Makers. Available for UK Mainland only. Terms and Conditions apply. Full terms and conditions can be found at vauxhallfleet.co.uk/testdrive/index/terms. **Telephone lines open Monday-Friday 9.00am to 5.00pm excluding Bank Holidays. Calls may be recorded or monitored for quality and/or training purposes.

Privacy Policy: For full details please visit vauxhall.co.uk/privacy

The invoice price, including delivery to Retailer, factory-fitted options, accessories fitted by the Retailer and number plates, is subject to VAT. Some feature descriptions in this guide may refer to, and some illustrations may show, optional equipment not included in the standard delivery. The information contained in this guide was accurate at the time of publication. We reserve the right to make changes in design and equipment. Please note that Vauxhall Retailers are not the agents of Vauxhall Motors Limited and are not authorised to bind Vauxhall Motors Limited by any specific or implied undertaking or representation. It is advisable to ensure that your motor insurance policy provides adequate cover for additional fitted options and accessories. The colours in this guide are only approximate actual colours. Illustrated optional equipment is available at extra charge. Availability, technical features and equipment provided on our vehicles can vary by model. For precise information on the equipment provided on our vehicles, please contact your local Vauxhall Retailer.

CROSSLAND X

Price and Specification Guide | 5 June 2020 | Model Year 2020.5



VAUXHALL

CONTENTS

To find the information you want use the links below to navigate around the guide:

[RANGE HIGHLIGHTS >](#)

Explore the Crossland X range and find your perfect model.

[MODELS >](#)

Find all the information you need about your chosen model.

[PRICES >](#)

Find on-the-road recommended retail prices.

[FEATURES/OPTIONS >](#)

Tailor your chosen model to suit your needs with everything from satellite navigation to rear-view camera and parking sensors.

[EXTERIOR COLOURS >](#)

Add some sparkle to your car with a metallic paint.

[WHEELS AND TYRES >](#)

Why not upgrade to a set of distinctive alloy wheels to give your car more presence.

[PERFORMANCE, FUEL ECONOMY AND EMISSIONS >](#)

Know how many miles you will get around town, the CO₂ figures and the 0-60 time.

[DIMENSIONS >](#)

Ensure your car will fit in the garage and know how much luggage you can take for a long weekend away.

[SPECIFICATIONS >](#)

Towing weights, engine details and other useful details you may need to know.

[ACCESSORIES >](#)

Add some practical touches to your car with our range of quality accessories.

[COMPANY CAR INFORMATION >](#)

Benefit in Kind company car tax, 3 day test drives and P11D.

[FURTHER INFORMATION >](#)

Price protection, vehicle excise duty, our range of additional products and much more.

CROSSLAND X RANGE HIGHLIGHTS



VX_CRO_30756.psd

GRIFFIN OTR from £19,330

Standard features include:

Infotainment:

- R4.0 IntelliLink system
 - Smartphone projection
 - 7-inch colour touchscreen
 - AM/FM/digital radio
 - Bluetooth® audio streaming/mobile phone portal
 - USB connection with iPod control

Interior convenience/styling:

- Air conditioning
- Cruise control with speed limiter
- Leather-covered steering wheel with audio controls
- Steering column adjustable for reach and rake

Exterior convenience/styling:

- Black roof and door mirrors
- Alloy-effect protective front and rear skid plates
- Dark-tinted rear windows
- Chrome-effect side window trim
- 17-inch diamond-cut Titan gloss alloy wheels

Safety/security:

- Switchable electronic stability programme
- Anti-lock braking system
- Front camera system
- Hill start assist
- LED headlights

Unique to Griffin:

- Front and rear floor mats (front Griffin-branded)
- Griffin badge



VX_CRO_30753.psd

SRI NAV OTR from £20,480

Features over Griffin:

- Navi 5.0 IntelliLink system
 - Fully integrated European sat nav system
 - 8-inch colour touchscreen
 - Voice control
 - Second USB charging connection
- Vauxhall Connect



VX_CRO_30752.psd

BUSINESS EDITION NAV OTR from £19,640

Difference vs SRi Nav:

Interior convenience/styling:

- Dual-zone electronic climate control
- Ambient LED lighting

Exterior convenience/styling:

- 16-inch alloy wheels
- Auto lighting/windscreen wipers

Safety/security:

- Remote control security alarm system
- Rear parking distance sensors

Please note: Business Edition Nav models do not feature the Black roof and door mirrors as standard, they are optional.



VX_CRO_30114.psd

ELITE OTR from £20,390

Features over Griffin:

Interior convenience/styling:

- Dual-zone electronic climate control
- Ambient LED lighting

Exterior convenience/styling:

- 17-inch diamond-cut Technical Grey alloy wheels
- Front fog lights
- Auto lighting/windscreen wipers

Safety/security:

- Remote control security alarm system
- Rear parking distance sensors

ELITE NAV OTR from £21,440

Elite Nav models additionally feature:

- Navi 5.0 IntelliLink system
 - Fully integrated European sat nav system
 - 8-inch colour touchscreen
 - Voice control
 - Second USB charging connection
- Vauxhall Connect

Please note: Elite and Elite Nav models do not feature the Black roof and door mirrors as standard, they are optional.

GRIFFIN



VX_CRO_30756.psd



VX_CRO_30751.tif

GRIFFIN ON-THE-ROAD PRICES

	5-door SUV		Insurance Group
	OTR RRP	CO ₂ (g/km)	
Petrol			
1.2 (83PS)	£19,330	142	8E
1.2 (110PS) Turbo	£20,420	140	13E
1.2 (130PS) Turbo auto	£22,210	146	16E
Diesel			
1.5 (102PS) Turbo D	£21,140	126	14E
1.5 (120PS) Turbo D auto	£23,120	137	16E

Please note: On-the-road recommended retail prices (RRP) include VAT at 20%, number plates and delivery to Retailer of £700.00 (inc. £116.67 VAT), 12 months' Vehicle Excise Duty and new vehicle first registration fee of £55.00. Excludes fuel and insurance.

All diesel models feature BlueInjection, see www.vauxhall.co.uk/adblue

FEATURES

Infotainment:

- R4.0 IntelliLink system
 - Smartphone projection, Apple CarPlay™ and Android Auto™
 - 7-inch colour touchscreen
 - AM/FM/digital radio
 - Bluetooth® audio streaming
 - Bluetooth® mobile phone portal
 - USB connection with iPod control

Interior convenience/styling:

- Air conditioning
- Cruise control with speed limiter
- Multi-function trip computer
- Leather-covered steering wheel
- Front and rear floor mats (front Griffin-branded)
- Steering column adjustable for reach and rake
- Steering wheel mounted audio controls
- 60/40 split-folding rear seat

Exterior convenience/styling:

- 17-inch diamond-cut Titan Gloss alloy wheels
- Black roof and door mirrors
- Side-protection mouldings
- Electrically adjustable/heated door mirrors
- Electrically operated front and rear windows
- Remote control central locking
- Alloy-effect protective front and rear skid plates
- Dark-tinted rear windows
- Chrome-effect side window trim

Safety/security:

- Switchable electronic stability programme
- Anti-lock braking system
- Front camera system
- Traction control
- Hill start assist
- Tyre pressure monitoring system
- Six airbags
- Emergency tyre inflation kit in lieu of spare wheel
- LED headlights

SRI NAV



VX_CRO_30753.psd



VX_CRO_30751.tif

SRI NAV ON-THE-ROAD PRICES

	5-door SUV		Insurance
	OTR RRP	CO ₂ (g/km)	Group
Petrol			
1.2 (83PS)	£20,480	142	8E
1.2 (110PS) Turbo	£21,570	140	13E
1.2 (130PS) Turbo auto	£23,360	146	18E
Diesel			
1.5 (102PS) Turbo D	£22,290	126	14E
1.5 (120PS) Turbo D auto	£24,270	137	18E

Please note: On-the-road recommended retail prices (RRP) include VAT at 20%, number plates and delivery to Retailer of £700.00 (inc. £116.67 VAT), 12 months' Vehicle Excise Duty and new vehicle first registration fee of £55.00. Excludes fuel and insurance.

All diesel models feature BlueInjection, see www.vauxhall.co.uk/adblue

FEATURES

Infotainment:

- Navi 5.0 IntelliLink system
 - Fully integrated European sat nav system
 - Smartphone projection, Apple CarPlay™ and Android Auto™
 - 8-inch colour touchscreen
 - AM/FM/digital radio
 - Bluetooth® audio streaming
 - Bluetooth® mobile phone portal
 - Voice control
 - USB connection with iPod control
- Vauxhall Connect

Interior convenience/styling:

- Air conditioning
- Cruise control with speed limiter
- Multi-function trip computer
- Leather-covered steering wheel
- Steering column adjustable for reach and rake
- Steering wheel mounted audio controls
- 60/40 split-folding rear seat

Exterior convenience/styling:

- 17-inch diamond-cut Titan Gloss alloy wheels
- Black roof and door mirrors
- Side-protection mouldings
- Electrically adjustable/heated door mirrors
- Electrically operated front and rear windows
- Remote control central locking
- Alloy-effect protective front and rear skid plates
- Dark-tinted rear windows
- Chrome-effect side window trim

Safety/security:

- Switchable electronic stability programme
- Anti-lock braking system
- Front camera system
- Traction control
- Hill start assist
- Tyre pressure monitoring system
- Six airbags
- Emergency tyre inflation kit in lieu of spare wheel
- LED headlights

BUSINESS EDITION NAV



VX_CRO_30752.psd



VX_CRO_30111.tif

BUSINESS EDITION NAV ON-THE-ROAD PRICES

	5-door SUV		Insurance Group
	OTR RRP	CO ₂ (g/km)	
Petrol			
1.2 (83PS)	£19,640	141	8E
1.2 (110PS) Turbo	£20,730	139	13E
1.2 (130PS) Turbo	£21,480	136	17E
1.2 (130PS) Turbo auto	£22,770	146	17E
Diesel			
1.5 (102PS) Turbo D	£21,450	124	14E
1.5 (120PS) Turbo D auto	£23,430	136	17E

Please note: On-the-road recommended retail prices (RRP) include VAT at 20%, number plates and delivery to Retailer of £700.00 (inc. £116.67 VAT), 12 months' Vehicle Excise Duty and new vehicle first registration fee of £55.00. Excludes fuel and insurance.

All diesel models feature BlueInjection, see www.vauxhall.co.uk/adblue

FEATURES

Infotainment:

- Navi 5.0 IntelliLink system
 - Fully integrated European sat nav system
 - Smartphone projection, Apple CarPlay™ and Android Auto™
 - 8-inch colour touchscreen
 - AM/FM/digital radio
 - Bluetooth® audio streaming
 - Bluetooth® mobile phone portal
 - Voice control
 - USB connection with iPod control
- Vauxhall Connect

Interior convenience/styling:

- Dual-zone electronic climate control
- Cruise control with speed limiter
- Multi-function trip computer
- Leather-covered steering wheel
- Steering column adjustable for reach and rake
- Steering wheel mounted audio controls
- Auto anti-dazzle rear-view mirror
- 60/40 split-folding rear seat
- Ambient LED lighting

Exterior convenience/styling:

- 16-inch alloy wheels
- Alloy-effect protective front and rear skid plates
- Side-protection mouldings
- Auto lighting/windscreen wipers
- Electrically adjustable/heated door mirrors
- Electrically operated front and rear windows
- Remote control central locking
- Dark tinted rear windows
- Chrome-effect side window trim

Safety/security:

- Switchable electronic stability programme
- Anti-lock braking system
- Front camera system
 - Lane departure warning
 - Speed sign recognition
- Traction control
- Hill start assist
- Tyre pressure monitoring system
- Six airbags
- Remote control security alarm system
- Rear parking distance sensors
- Emergency tyre inflation kit in lieu of spare wheel
- LED headlights

ELITE



VX_CRO_30114.psd



VX_CRO_26695.tif

ELITE ON-THE-ROAD PRICES

	5-door SUV		Insurance Group
	OTR RRP	CO ₂ (g/km)	
Petrol			
1.2 (83PS)	£20,390	142	8E
1.2 (110PS) Turbo	£21,480	140	14E
1.2 (130PS) Turbo	£22,230	137	18E
1.2 (130PS) Turbo auto	£23,270	146	18E
Diesel			
1.5 (102PS) Turbo D	£22,200	126	14E
1.5 (120PS) Turbo D auto	£24,185	137	17E

ELITE NAV ON-THE-ROAD PRICES

Petrol			
1.2 (83PS)	£21,440	142	8E
1.2 (110PS) Turbo	£22,530	140	14E
1.2 (130PS) Turbo	£23,280	137	18E
1.2 (130PS) Turbo auto	£24,320	146	18E
Diesel			
1.5 (102PS) Turbo D	£23,250	126	14E
1.5 (120PS) Turbo D auto	£25,235	137	17E

Please note: On-the-road recommended retail prices (RRP) include VAT at 20%, number plates and delivery to Retailer of £700.00 (inc. £116.67 VAT), 12 months' Vehicle Excise Duty and new vehicle first registration fee of £55.00. Excludes fuel and insurance.

All diesel models feature BlueInjection, see www.vauxhall.co.uk/adblue

FEATURES

Infotainment:

- R4.0 IntelliLink system
 - Smartphone projection, Apple CarPlay™ and Android Auto™
 - 7-inch colour touchscreen
 - AM/FM/digital radio
 - Bluetooth® audio streaming
 - Bluetooth® mobile phone portal
 - USB connection with iPod control

Interior convenience/styling:

- Dual-zone electronic climate control
- Cruise control with speed limiter
- Multi-function trip computer
- Leather-covered steering wheel
- Steering column adjustable for reach and rake
- Steering wheel mounted audio controls
- Auto anti-dazzle rear-view mirror
- 60/40 split-folding rear seat
- Ambient LED lighting

Exterior convenience/styling:

- 17-inch diamond-cut Technical Grey alloy wheels
- Alloy-effect protective front and rear skid plates
- Side-protection mouldings
- Front fog lights
- Auto lighting/windscreen wipers

- Electrically adjustable/heated door mirrors
- Electrically operated front and rear windows
- Dark-tinted rear windows
- Chrome-effect side window trim

Safety/security:

- Switchable electronic stability programme
- Anti-lock braking system • Six airbags
- Front camera system
 - Lane departure warning
 - Speed sign recognition
- Traction control/hill start assist
- Tyre pressure monitoring system
- Remote control central locking/alarm system
- Rear parking distance sensors
- Emergency tyre inflation kit in lieu of spare wheel
- LED headlights

ELITE NAV MODELS ADDITIONALLY FEATURE

Infotainment:

- Navi 5.0 IntelliLink system
 - Fully integrated European sat nav system
 - 8-inch colour touchscreen
 - Voice control
 - Second USB charging connection
- Vauxhall Connect

CROSSLAND X PRICES

	Pack Code	Fuel Type	Price (£)	VAT (£)	Total (£)	On-the-road RRP (£)	Financial Year 2020/21 BiK 20% (£)	WLTP Combined CO ₂ (g/km)# - pack code	Insurance Groups
GRIFFIN									
1.2 (83PS)	GZ75 E1GG	Petrol	15,300.00	3,060.00	18,360.00	19,330.00	98.47	142	8E
1.2 (110PS) Turbo	GZ75 EL6G	Petrol	16,208.33	3,241.67	19,450.00	20,420.00	104.10	140	13E
1.2 (130PS) Turbo auto	GZ75 EGFG	Petrol	17,700.00	3,540.00	21,240.00	22,210.00	117.00	146	16E
1.5 (102PS) Turbo D	GZ75 HE6G	Diesel	16,841.67	3,368.33	20,210.00	21,140.00	97.57	126	14E
1.5 (120PS) Turbo D auto	GZ75 HAFG	Diesel	18,458.33	3,691.67	22,150.00	23,120.00	114.23	137	16E
SRI NAV									
1.2 (83PS)	GZ75 E1GF	Petrol	16,258.33	3,251.67	19,510.00	20,480.00	104.42	142	8E
1.2 (110PS) Turbo	GZ75 EL6F	Petrol	17,166.67	3,433.33	20,600.00	21,570.00	110.03	140	13E
1.2 (130PS) Turbo auto	GZ75 EGFF	Petrol	18,658.33	3,731.67	22,390.00	23,360.00	123.13	146	18E
1.5 (102PS) Turbo D	GZ75 HE6F	Diesel	17,800.00	3,560.00	21,360.00	22,290.00	102.93	126	14E
1.5 (120PS) Turbo D auto	GZ75 HAFF	Diesel	19,416.67	3,883.33	23,300.00	24,270.00	119.98	137	18E
BUSINESS EDITION NAV									
1.2 (83PS)	GH75 E1GR	Petrol	15,558.33	3,111.67	18,670.00	19,640.00	100.07	141	8E
1.2 (110PS) Turbo	GH75 EL6R	Petrol	16,466.67	3,293.33	19,760.00	20,730.00	102.28	139	13E
1.2 (130PS) Turbo	GH75 EK6R	Petrol	17,091.67	3,418.33	20,510.00	21,480.00	106.03	136	17E
1.2 (130PS) Turbo auto	GH75 EGFR	Petrol	18,166.67	3,633.33	21,800.00	22,770.00	119.98	146	17E
1.5 (102PS) Turbo D	GH75 HE6R	Diesel	17,100.00	3,420.00	20,520.00	21,450.00	95.48	124	14E
1.5 (120PS) Turbo D auto	GH75 HAFR	Diesel	18,716.67	3,743.33	22,460.00	23,430.00	115.78	136	17E

Crossland X's petrol and diesel engines meet the Real Driving Emissions Step 2 (RDE2) standards.

WLTP Combined CO₂ (g/km) figures, valid 3 March 2020, are based on a configured vehicle as per pack code for UK with no options fitted.

#Fuel consumption and CO₂ figures are determined according to the WLTP test cycle. CO₂ figures, BiK values and RRP pricing shown above are for a standard vehicle without any additional optional equipment. CO₂ figures are used to calculate Vehicle Excise Duty (VED) for the first registration of the vehicle and BiK. The addition of optional extras could increase the certified CO₂ emission output. This in turn may affect the amount of VED payable upon registration, and, for company car drivers, the P11D value and the amount of Benefit in Kind (BiK) tax payable. Figures shown are for comparison purposes and should only be compared to the fuel consumption and CO₂ values of other cars tested to the same technical standard. The fuel consumption achieved, and CO₂ produced, in real world conditions will depend upon a number of factors including, but not limited to: the accessories fitted (pre and post registration); variations in weather; driving styles and vehicle load. The WLTP (Worldwide Harmonised Light Vehicles Test Procedure) is used to measure fuel consumption and CO₂ figures. Full data relating to WLTP test cycles can be found at: www.vauxhall.co.uk/wltp

Please note: On-the-road recommended retail prices (RRP) include number plates and delivery to Retailer of £700.00 (inc. £116.67 VAT), 12 months' Vehicle Excise Duty and new vehicle first registration fee of £55.00. Excludes fuel and insurance. Company Car Benefit in Kind (BiK) rates are monthly based on the standard paint price.

CROSSLAND X PRICES

	Pack Code	Fuel Type	Price (£)	VAT (£)	Total (£)	On-the-road RRP (£)	Financial Year 2020/21 BiK 20% (£)	WLTP Combined CO ₂ (g/km)# - pack code	Insurance Groups
ELITE									
1.2 (83PS)	GH75 E1GJ	Petrol	16,183.33	3,236.67	19,420.00	20,390.00	103.95	142	8E
1.2 (110PS) Turbo	GH75 EL6J	Petrol	17,091.67	3,418.33	20,510.00	21,480.00	109.58	140	14E
1.2 (130PS) Turbo	GH75 EK6J	Petrol	17,716.67	3,543.33	21,260.00	22,230.00	109.78	137	18E
1.2 (130PS) Turbo auto	GH75 EGFJ	Petrol	18,583.33	3,716.67	22,300.00	23,270.00	122.65	146	18E
1.5 (102PS) Turbo D	GH75 HE6J	Diesel	17,725.00	3,545.00	21,270.00	22,200.00	102.52	126	14E
1.5 (120PS) Turbo D auto	GH75 HAFJ	Diesel	19,345.83	3,869.17	23,215.00	24,185.00	119.57	137	17E
ELITE NAV									
1.2 (83PS)	GH75 E1GN	Petrol	17,058.33	3,411.67	20,470.00	21,440.00	109.37	142	8E
1.2 (110PS) Turbo	GH75 EL6N	Petrol	17,966.67	3,593.33	21,560.00	22,530.00	115.00	140	14E
1.2 (130PS) Turbo	GH75 EK6N	Petrol	18,591.67	3,718.33	22,310.00	23,280.00	115.03	137	18E
1.2 (130PS) Turbo auto	GH75 EGFN	Petrol	19,458.33	3,891.67	23,350.00	24,320.00	128.25	146	18E
1.5 (102PS) Turbo D	GH75 HE6N	Diesel	18,600.00	3,720.00	22,320.00	23,250.00	107.42	126	14E
1.5 (120PS) Turbo D auto	GH75 HAFN	Diesel	20,220.83	4,044.17	24,265.00	25,235.00	124.82	137	17E

Crossland X's petrol and diesel engines meet the Real Driving Emissions Step 2 (RDE2) standards.

WLTP Combined CO₂ (g/km) figures, valid 3 March 2020, are based on a configured vehicle as per pack code for UK with no options fitted.

#Fuel consumption and CO₂ figures are determined according to the WLTP test cycle. CO₂ figures, BiK values and RRP pricing shown above are for a standard vehicle without any additional optional equipment. CO₂ figures are used to calculate Vehicle Excise Duty (VED) for the first registration of the vehicle and BiK. The addition of optional extras could increase the certified CO₂ emission output. This in turn may affect the amount of VED payable upon registration, and, for company car drivers, the P11D value and the amount of Benefit in Kind (BiK) tax payable. Figures shown are for comparison purposes and should only be compared to the fuel consumption and CO₂ values of other cars tested to the same technical standard. The fuel consumption achieved, and CO₂ produced, in real world conditions will depend upon a number of factors including, but not limited to: the accessories fitted (pre and post registration); variations in weather; driving styles and vehicle load. The WLTP (Worldwide Harmonised Light Vehicles Test Procedure) is used to measure fuel consumption and CO₂ figures. Full data relating to WLTP test cycles can be found at: www.vauxhall.co.uk/wltp

Please note: On-the-road recommended retail prices (RRP) include number plates and delivery to Retailer of £700.00 (inc. £116.67 VAT), 12 months' Vehicle Excise Duty and new vehicle first registration fee of £55.00. Excludes fuel and insurance. Company Car Benefit in Kind (BiK) rates are monthly based on the standard paint price.

STANDARD FEATURES

ALL MODELS

Driver/passenger airbags

- Driver's and front passenger's airbags with active-vent technology – Adapts the airbag pressure based on the position of the seat, reducing it the closer the seat is to the fascia.
 - Front seat side-impact airbags
 - Full-size curtain airbags for driver, front seat passenger and outer rear seat passengers
-

Seating

- Height-adjustable front seat head restraints • Height-adjustable outer rear seat head restraints
 - Anti-submarining ramps in front seats
-

Seatbelts

- Inertia-reel lap and diagonal seatbelts for all seats
 - Dual seatbelt pretensioners on front seats – These keep the pelvis better coupled to the vehicle in an impact; the pelvis and therefore the legs are allowed less forward movement, reducing the risk of hard knee contact with the fascia.
 - Pretensioners on outer rear seatbelt retractors • Load limiters on front and outer rear seatbelt retractors
 - Smart seatbelt reminder for front and rear seats – Warning lights and audible warning.
-

Child safety

- Deactivation switch for front passenger's front and side-impact airbags – Permits the safe use of a child seat in the front passenger seat.
 - ISOFIX child seat mountings incorporating top tether anchor points located on outer rear seats (does not include child seat) – Allows ISOFIX child safety seats to be securely fixed into the car. The ISOFIX mounting system reduces forward movement in an accident and makes the child seat easier to install.
 - Child-proof locks on rear doors
-

Driver/passenger safety

- Energy-absorbing steering column • Side-impact protection beams
 - Reinforced passenger safety cell • Deformation zones front and rear
-

Pedestrian safety

- Collapsible windscreen wiper system – Designed to reduce pedestrian head injuries.
 - Upper and lower bumper design – Reduces upper and lower leg injuries.
-

Braking and stability

- Switchable Electronic Stability Programme (ESP) • Anti-lock Braking System (ABS)
 - Corner stability control • Traction control • Hill start assist
 - Engine drag torque control – Improves directional stability by preventing the driven wheels from locking on slippery surfaces under the influence of engine braking.
 - Hydraulic brake assist • Hydraulic brake boost • Electronic brakeforce distribution
-

Tyre pressure

- Deflation detection system
-

STANDARD FEATURES

ALL MODELS

Steering

- Speed-sensitive power-assisted steering
 - Reach and rake adjustable steering
-

Cruise control with speed limiter and intelligent speed adaptation

Cruise control feature – enables you to maintain a constant speed – making it ideal for economical motorway driving. The speed limiter function – can be set to ensure that you do not exceed the speed limit and can be easily overridden if required. Working in conjunction with speed sign recognition, when a new speed limit is detected a message appears in the driver information display. You can then set the cruise control to the new speed limit with a simple press on a steering wheel button.

- Steering wheel mounted controls
-

Front camera system

A range of driver assistance and safety features are controlled by the front camera system.

Lane departure warning: If the driver has not actively steered or signalled, the lane departure warning system warns when the car moves outside of lane markings at speeds above 37mph.

- Warning light in instrument cluster
- Audible warning
- Facia on/off switch

Speed sign recognition: Detects and then displays speed limits, reducing uncertainty and the risk of speeding.

- Recognises different road signs, including temporary speed restrictions
 - Displays reminder in the instrument cluster
 - On Nav models, where the front camera system is unable to detect any speed signs the speed limit stored in the navigation database will be displayed
-

Security features

- Electronically protected audio equipment
 - Engine deadlock immobiliser
 - Visible Vehicle Identification Number (VIN)
 - Locking wheel bolts for alloy wheels
 - Luggage area cover
-

Remote control central locking

- Operates on doors, tailgate and fuel filler flap
 - Deadlocking
 - Driver's internal central locking activation switch
-

Instrumentation

- Speedometer
 - Rev counter
 - Fuel gauge with low fuel level warning light
 - Water temperature gauge with warning light
 - Shift-up indication light – Indicates when to change gear for optimum fuel economy
-

Driver information display (centrally located in instrument cluster)

- Displays trip computer data
 - Total mileage
 - Service-due indicator
 - Tyre pressure monitoring system
 - Monochrome display (non-Nav models)
 - 3.5-inch colour information display
-

Multi-function trip computer (displayed on driver information display)

- Trip mileage
 - Vehicle range based on remaining fuel
 - Average speed
 - Average fuel economy
 - Instantaneous fuel economy
-

Central facia display (format dependent on infotainment unit)

- Audio information
 - Digital clock with automatic RDS time adjustment
 - Outside air temperature with ice warning function
 - Additional features dependent on infotainment unit (see infotainment for details)
-

Audio features

- Six speakers (four front, two rear)
 - Steering wheel mounted audio controls
-

Rear seating

- Three-person layout
 - 60/40 split-folding rear seat
 - Height-adjustable and removable outer seat head restraints
-

Additional heating and ventilation features

- Four adjustable facia vents
 - Windscreen demist vents
 - Side window demist vents
 - Heated rear screen with timed cut-off
-

Convenience features

- Front 12-volt electrical accessory socket
 - Front and rear passenger assist handles
-

STANDARD FEATURES

ALL MODELS

Interior lighting

- Courtesy lighting operated by door switches
 - Rear courtesy light
-

Interior storage

- Glovebox with lid
 - Front door pockets with 1.5-litre bottle holder
 - Two drinks holders in centre console
 - Rear door pockets with 0.5-litre bottle holder
 - Open storage compartment in centre console
-

Luggage area

- Luggage compartment foldable cover
 - Illuminated luggage area
 - Fully carpeted luggage area
-

Exterior lighting features

- LED daytime running lights
 - LED headlights
 - Automatic lighting control
 - Lights-on audible warning
 - Manual headlight beam levelling
 - High-level LED centre rear brake light
 - Rear fog light
 - Reversing light
 - Hazard warning lights
 - Door-to-door illumination
 - Welcome lighting
-

Windscreen wipers

- Two-speed windscreen wipers with variable intermittent wipe
 - Intermittent rear window wash/wipe
-

Door mirrors

- Twin electrically adjustable/heated door mirrors (wide-angle on driver's side) with automatic timed cut-off
 - Manually foldable door mirrors
-

Windows

- Electrically operated front and rear windows with safety autoreverse and one-touch facility
 - Heated rear window
 - Solar heat-absorbing windscreen
 - Tinted windows
-

Body styling

- Side-protection mouldings
 - Chrome-effect front grille bar
 - Body-colour door handles
 - Rear spoiler
-

FEATURES/OPTIONS

DRIVER ASSISTANCE

	Griffin	SRi Nav	Business Edition Nav	Elite/ Elite Nav	Price (£) exc. VAT	Price (£) inc. VAT
<p>Safety Pack</p> <hr/> <p>Driver drowsiness system The system monitors driving time and driving behaviour to help prevent accidents caused by tiredness.</p> <hr/> <p>Forward collision alert The system operates automatically from 3mph and gives an audible warning as well as a visual warning when approaching another vehicle too quickly.</p> <hr/> <p>Automatic emergency braking with pedestrian detection The system works automatically in conjunction with forward collision alert, at speeds between 3mph and 53mph, and detects both vehicles and pedestrians. If no avoiding action is taken by the driver, at speeds below 19mph the system automatically slows the vehicle to a full stop with emergency braking of 0.9g. At speeds from 19mph to 53mph it brakes automatically to reduce speed by a maximum of 14mph – to reduce speed even further the driver must brake him/herself. The operational speed range of the system depends on the detected obstacle (mobile target: from 3 to 53mph; fixed target: from 3 to 50mph; pedestrian: from 3 to 37mph). Vauxhall driver assistance systems are intended to support the driver within the system-imminent limitations. The driver remains responsible for the driving task at all times.</p>			○	○	416.67	500.00
<p>Rear-view Camera Pack (available on non-Nav models only)</p> <hr/> <p>Rear-view camera The rear-view camera gives a clear view of the area behind your car and helps place the car perfectly, without needing to strain your neck. • Activated when reverse gear selected • Camera view appears in infotainment screen • Rear bumper and grid lines shown as reference points</p> <hr/> <p>Front and rear parking distance sensors An audible warning alerts you to obstacles in front of and behind you. A series of beeps are sounded as you approach the obstacle, increasing in frequency as the distance closes.</p>				○	279.17	335.00

○ = Optional at extra cost.

FEATURES/OPTIONS

DRIVER ASSISTANCE CONTINUED

	Griffin	SRi Nav	Business Edition Nav	Elite/ Elite Nav	Price (£) exc. VAT	Price (£) inc. VAT
<p>Rear-view Camera Pack Plus (available on Nav models)</p> <hr/> <p>Panoramic rear-view camera The rear-view camera gives a clear view of the area behind your car and helps place the car perfectly, without needing to strain your neck.</p> <ul style="list-style-type: none"> • The 180° panoramic view detects traffic coming from the side, helping you reverse out of perpendicular parking spaces more safely • Overhead view allows you to see clearly how close you are to obstacles behind you • Activated when reverse gear selected • Camera view appears in infotainment screen • Rear bumper and grid lines shown as reference points <hr/> <p>Front and rear parking distance sensors An audible warning alerts you to obstacles in front of and behind you. A series of beeps are sounded as you approach the obstacle, increasing in frequency as the distance closes.</p>			○	○	379.17	455.00
<p>Parking sensors</p> <ul style="list-style-type: none"> • Rear parking distance sensors – audible warning. 			●	●		
<ul style="list-style-type: none"> • Front and rear parking distance sensors • Audible warning 			○	○	200.00	240.00

● = Standard equipment. ○ = Optional at extra cost.

FEATURES/OPTIONS

SECURITY

	Griffin	SRi Nav	Business Edition Nav	Elite/Elite Nav	Price (£) exc. VAT	Price (£) inc. VAT
Remote control central locking • One folding key/one static key, each with integral remote control function	●	●				
Remote control central locking • Two folding keys, each with integral remote control function			●	●		
Remote control security alarm system • Remote control (operates in conjunction with central locking)			●	●		

INTERIOR STYLING

Griffin/SRi Nav interior décor Steering wheel: • Three-spoke design • Leather-covered • Satin chrome-effect bezel Facia and door trim: • White facia and door panel inserts • Black door panels with black Atlantis cloth inserts • Chrome-effect interior door handles Infotainment surround: • Black	●	●				
Business Edition Nav/Elite/Elite Nav interior décor Steering wheel: • Three-spoke design • Leather-covered • Satin chrome-effect bezel Facia and door trim: • Tioga grey facia and door panel inserts • Black door panels with medium grey premium leather-effect inserts • Chrome-effect interior door handles Infotainment surround: • Piano black			●	●		

● = Standard equipment.

FEATURES/OPTIONS

INFOTAINMENT

	Griffin	SRI Nav	Business Edition Nav	Elite	Elite Nav	Price (£) exc. VAT	Price (£) inc. VAT
<p>R4.0 IntelliLink touchscreen infotainment system – For use with media players, USB memory sticks, mobile phones and smartphone apps.</p> <p>Onboard features:</p> <ul style="list-style-type: none"> • 7-inch colour touchscreen • AM/FM stereo radio with 36 station presets • RDS with Traffic Programme <p>Media connections:</p> <ul style="list-style-type: none"> • USB connection with iPod control • Bluetooth® A2DP audio streaming (Advanced Audio Distribution Profile) <p>Mobile phone portal:</p> <ul style="list-style-type: none"> • Bluetooth® connectivity • Handsfree calls via steering wheel controls • Vehicle microphone • Phone book access – The majority of the phone’s functions – contacts/last calls/missed calls etc. are mirrored on IntelliLink’s display and are easily navigated using the touchscreen (features dependent on mobile phone). <p>Smartphone interface:</p> <ul style="list-style-type: none"> • Apple CarPlay™ • Android Auto™ 	●			●			
<p>Navi 5.0 IntelliLink touchscreen navigation and infotainment system – For use with media players, USB memory sticks, mobile phones and smartphone apps.</p> <p>Onboard features:</p> <ul style="list-style-type: none"> • 8-inch colour touchscreen • Digital radio/AM/FM stereo radio • RDS with Traffic Programme <p>Navigation features:</p> <ul style="list-style-type: none"> • Satellite navigation system • 3D street level mapping • European coverage <p>Media connections:</p> <ul style="list-style-type: none"> • 2 USB connections, upper with iPod control and smartphone projection functions • Bluetooth® A2DP audio streaming (Advanced Audio Distribution Profile) <p>Mobile phone portal:</p> <ul style="list-style-type: none"> • Bluetooth® connectivity • Handsfree calls via steering wheel controls • Vehicle microphone • Phone book access – The majority of the phone’s functions – contacts/last calls/missed calls etc. are mirrored on IntelliLink’s display and are easily navigated using the touchscreen (features dependent on mobile phone). <p>Smartphone interface:</p> <ul style="list-style-type: none"> • Apple CarPlay™ • Android Auto™ 		●	●		●		
<p>Vauxhall Connect</p> <p>e-Call and b-Call:</p> <p>Help when you need it, 24/7, 365 days a year, that’s what you get with new Vauxhall Connect. In an emergency or breakdown, you’ll be put in touch with a trained advisor, with just the touch of a button.</p> <p>– Additional Vauxhall Connect services will be introduced later in the model year. Sign up to MyVauxhall at Vauxhall.co.uk to be kept notified about the introduction of new Vauxhall Connect services.</p>		●	●	○	●	237.50	285.00

● = Standard equipment. ○ = Optional at extra cost.

FEATURES/OPTIONS

SEATING AND COMFORT

	Griffin	SRi Nav	Business Edition Nav	Elite/ Elite Nav	Price (£) exc. VAT	Price (£) inc. VAT
Comfort front seats Driver's seat (eight-way adjustable): • Height (up/down) • Reach (fore/aft) • Backrest (upright/recline) • Head restraint (up/down) Front passenger's seat (six-way adjustable): • Reach (fore/aft) • Backrest (upright/recline) • Head restraint (up/down)	●	●	●	●		
Seat trim: • Soul black fabric seat trim inserts • Medium grey fabric inner side bolsters • Black fabric outer side bolsters	●	●				
• Florey black fabric seat trim inserts • Medium grey fabric inner side bolsters • Black leather-effect outer side bolsters			●	●		
Ergonomic active front seats (AGR-approved)* Driver's and front passenger's seat (16-way adjustable): • Height • Reach • Tilt (electrical) • Backrest • Seat cushion extension • Lumbar adjustment (four-way electrical) • Head restraint Convenience features: • 12-volt power outlet behind front seats • Covered storage compartment in centre console Seat trim: • Florey black fabric seat trim inserts • Medium grey fabric inner side bolsters • Black leather-effect outer side bolsters			○	○	354.17	425.00
Siena leather seat trim with ergonomic active front seats (AGR-approved)* Seat trim: • Siena leather seat trim inserts and inner side bolsters • Black premium leather-effect outer side bolsters • Jet black stitching – Winter Pack and Versatility Pack added with Siena leather seat trim.			○	○	1,404.17	1,685.00
Centre rear seat head restraint Fitted in conjunction with Versatility Pack. Not available separately.			□	□		

*AGR (The Campaign for Healthier Backs) is an independent centre of excellence for ergonomics, based in Germany.

● = Standard equipment. ○ = Optional at extra cost. □ = Available as part of an extra-cost option pack.

FEATURES/OPTIONS

HEATING AND VENTILATION

	Griffin	SRi Nav	Business Edition Nav	Elite/ Elite Nav	Price (£) exc. VAT	Price (£) inc. VAT
Air conditioning • Air recirculation facility • Cabin particular filter – removes dust, airborne particles and pollen. • Multi-speed fan • Illuminated controls	●	●				
Electronic climate control with air conditioning • Dual-zone control – allows different temperature settings for driver and front passenger • Advanced predictive logic control system using a sun sensor • Charcoal filter – removes dust, airborne particles, pollen and unpleasant odours • Automatic air direction and fan speed with manual override • Illuminated controls			●	●		
Winter Pack  • Heated front seats • Electrically heated leather-covered steering wheel			○	○	295.83	355.00

INTERIOR CONVENIENCE

12-volt power outlet behind front seats – Fitted in conjunction with ergonomic active front seats. Not available separately.			□	□		
Front and rear floor mats (front Griffin-branded)	●					
Versatility Pack • Sliding 60/40 rear seat base • Centre rear seat armrest allowing access to luggage compartment • Adjustable rear seat backrest • 60/40 split-folding rear seat back • Centre rear seat head restraint			○	○	312.50	375.00

INTERIOR STORAGE

• Storage pocket on front seat backs			●	●		
• Flex Floor with under-floor divider			○	○	62.50	75.00

● = Standard equipment. ○ = Optional at extra cost. □ = Available as part of an extra-cost option pack.

FEATURES/OPTIONS

INTERIOR LIGHTING

	Griffin	SRi Nav	Business Edition Nav	Elite/ Elite Nav	Price (£) exc. VAT	Price (£) inc. VAT
Premium lighting • Ambient facia/centre console downlighter • Ambient LED lighting in front doors, facia and gear shift surround • Front map reading lights			●	●		

EXTERIOR LIGHTING

LED headlights	●	●	●	●		
Front fog lights				●		

EXTERIOR CONVENIENCE







Sight and Light Pack • Automatically dimming anti-dazzle rear-view mirror • Rain-sensitive windscreen wipers • Tunnel detection for automatic lighting control • Driver's and front passenger's illuminated vanity mirrors with flip-up cover • Rear reading lights			●	●		
Heated windscreen (operated by heated rear window button)			○	○	133.33	160.00
Roof rails, silver-effect			○	○	125.00	150.00

EXTERIOR STYLING

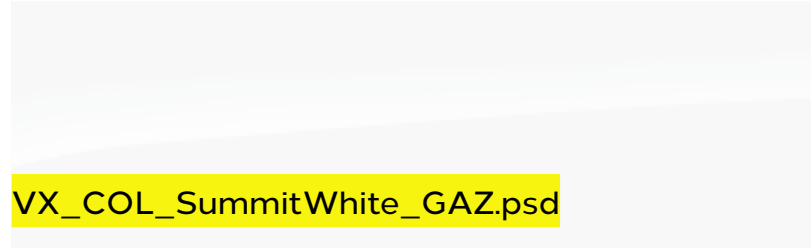
Body styling • Alloy-effect protective front and rear skid plates	●	●	●	●		
• Chrome-effect side window trim	●	●	●	●		
Windows • Dark-tinted rear windows	●	●	●	●		

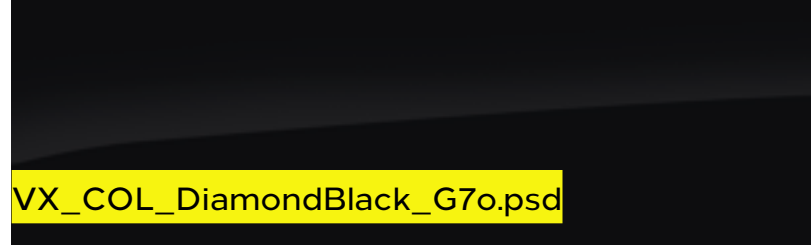
● = Standard equipment. ○ = Optional at extra cost.



EXTERIOR COLOURS

					Griffin	SRi Nav	Business Edition Nav	Elite/ Elite Nav	Price (£) exc. VAT	Price (£) inc. VAT
Two-coat		Navy Blue metallic			●	●	●	●		
	VX_COL_NavyBlueG4B.psd									
Brilliant		Summit White			○	○	○	○	266.67	320.00
	VX_COL_SummitWhite_GAZ.psd									
Two-coat		Quartz Grey metallic		Persian Blue metallic	○	○	○	○	458.33	550.00
		Diamond Black metallic		Moonstone Grey metallic						
	VX_COL_QuartzGrey_G4i.psd		VX_COL_PersianBlue_GDS.psd							
	VX_COL_DiamondBlack_G7o.psd		VX_COL_MoonstoneGrey_G4o.psd							
Two-coat		Power Orange Premium		Hot Red Premium	○	○	○	○	541.67	650.00
	VX_COL_PowerOrange_GPQ.psd		VX_COL_HotRed_G1R.psd							

The colours reproduced may vary slightly from the actual paint colour. As a result they should be used as a guide only. Your Vauxhall Retailer has a comprehensive display of our paint samples.

● = Standard equipment. ○ = Optional at extra cost.

ROOF AND DOOR MIRROR COLOURS

	Griffin	SRi Nav	Business Edition Nav	Elite/Elite Nav	Price (£) exc. VAT	Price (£) inc. VAT
Body-colour roof and door mirrors	N/C	N/C	●	●		
 <p>Diamond Black roof and door mirrors</p> <ul style="list-style-type: none"> • Standard on Griffin and SRi Nav models with Navy Blue, Diamond Black, Summit White, Persian Blue, Quartz Grey, Moonstone Grey, Hot Red and Power Orange exterior colours • Optional on Business Edition and Elite models with Summit White, Persian Blue, Quartz Grey, Moonstone Grey, Hot Red and Power Orange exterior colours <p>VX_CRO_26853.psd</p>	●	●	○	○	333.33	400.00
 <p>Summit White roof and door mirrors</p> <ul style="list-style-type: none"> • Optional on Business Edition and Elite models with Navy Blue, Diamond Black, Persian Blue, Quartz Grey, Moonstone Grey and Power Orange exterior colours <p>VX_CRO_26855.psd</p>			○	○	333.33	400.00

The colours reproduced may vary slightly from the actual paint colour. As a result they should be used as a guide only. Your Vauxhall Retailer has a comprehensive display of our paint samples.

● = Standard equipment. ○ = Optional at extra cost. N/C = No-cost option.

WHEELS AND TYRES

	Griffin	SRI Nav	Business Edition Nav	Elite/ Elite Nav	Price (£) exc. VAT	Price (£) inc. VAT
<p>16-inch steel emergency spare wheel (in lieu of emergency tyre inflation kit).</p>	○	○	○	○	100.00	120.00
 <p>17-inch diamond-cut Titan Gloss multi-spoke alloy wheels</p> <ul style="list-style-type: none"> • 215/50 R 17 tyres • Emergency tyre inflation kit (in lieu of spare wheel) 	●	●				
 <p>16-inch silver four twin-spoke alloy wheels</p> <ul style="list-style-type: none"> • 195/60 R 16 ultra low rolling resistance tyres • Emergency tyre inflation kit (in lieu of spare wheel) 			●			
 <p>17-inch diamond-cut Technical Grey multi-spoke alloy wheels</p> <ul style="list-style-type: none"> • 215/50 R 17 tyres • Emergency tyre inflation kit (in lieu of spare wheel) 				●		
 <p>17-inch silver-effect twin-spoke alloy wheels</p> <ul style="list-style-type: none"> • 215/50 R 17 tyres • Emergency tyre inflation kit (in lieu of spare wheel) 			○		333.33	400.00

● = Standard equipment. ○ = Optional at extra cost.

PERFORMANCE, FUEL ECONOMY AND EMISSIONS

	Performance (manufacturer's figures)		Fuel economy mpg (litres/100km)#		CO ₂ emissions g/km#		Vehicle Excise Duty*		BiK rates from - 2020/21 tax year
	Maximum speed (mph)	Acceleration 0-60mph (sec)	Combined Low	Combined High	Combined Low	Combined High	First year rate	Standard rate	
1.2 (83PS)	106	13.6	42.8 (6.6)	47.1 (6.0)	141	148	£215	£145	31%
1.2 (110PS) Turbo	116	10.2	44.8 (6.3)	47.1 (6.0)	139	147	£215	£145	30%
1.2 (130PS) Turbo	125	9.3	44.8 (6.3)	47.9 (5.9)	136	143	£215	£145	30%
1.2 (130PS) Turbo auto	123	9.5	42.2 (6.7)	44.1 (6.4)	146	152	£215	£145	32%
1.5 (102PS) Turbo D	111	11	57.7 (4.9)	61.4 (4.6)	124	129	£175	£145	27%
1.5 (120PS) Turbo D auto	114	10.8	52.2 (5.4)	55.4(5.1)	136	141	£215	£145	30%

#Figures shown are for comparison purposes and should only be compared to the fuel consumption and CO₂ values of other cars tested to the same technical standard. The fuel consumption achieved, and CO₂ produced, in real world conditions will depend upon a number of factors including, but not limited to: the accessories fitted (pre and post registration); variations in weather; driving styles and vehicle load. The WLTP (Worldwide Harmonised Light Vehicles Test Procedure) is used to measure fuel consumption and CO₂ figures. The CO₂ figures display a range to reflect the highest value for the highest emitting version with all available options added, through to a minimum value to represent the lowest emitting version in standard specification.

*Correct at time of publication.

DIMENSIONS

Loadspace Dimensions

Maximum length (behind rear seats)	793 (31.2)
Maximum length (rear seats folded)	1483 (58.4)
Maximum width	1000 (39.4)
Width between wheel arches	947 (37.3)
Maximum height	894 (35.2)
Luggage Capacities* litres (cu.ft.)	
Rear seats up (under luggage compartment cover)	410 (14.5)
Rear seats up with optional sliding rear seats in forward-most position	520 (18.4)
Rear seats folded (to upper edge of front seat back)	810 (28.6)
Rear seats folded (to roof)	1255 (44.3)

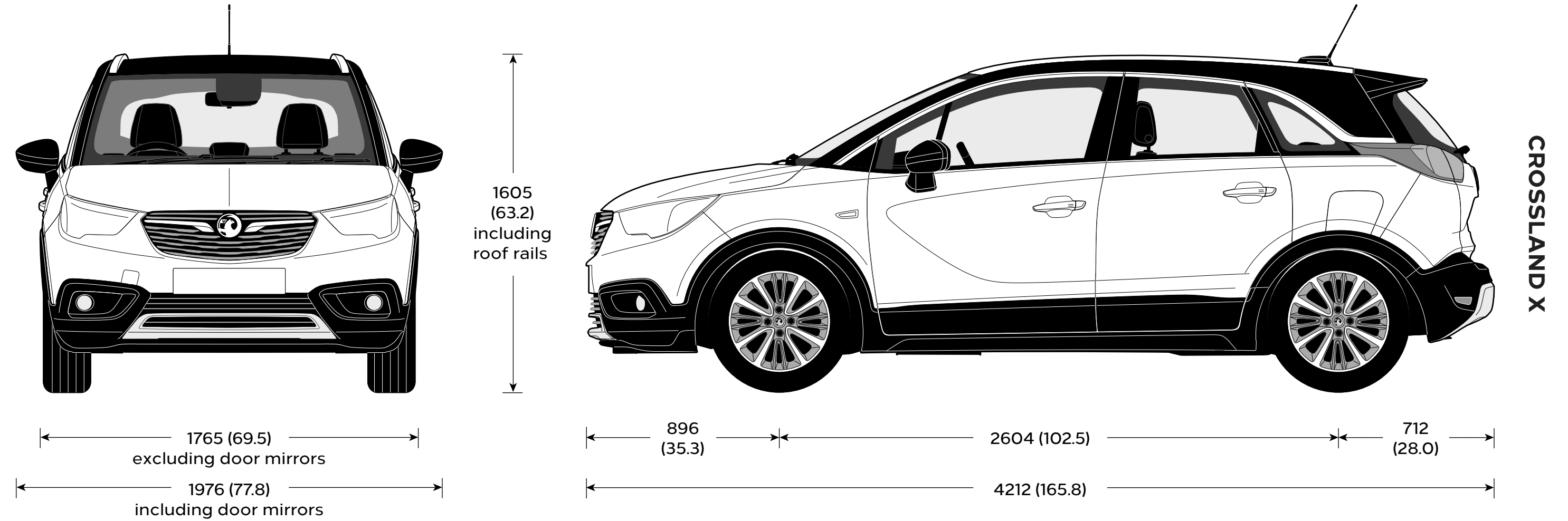

All measurements are in mm (inches) unless stated otherwise.

*Measured using the ECIE method.

SPECIFICATIONS

Transmission

Five-speed manual gearbox:

Petrol engines: 1.2 (83PS)

Six-speed manual gearbox:

Petrol engines: 1.2 (110/130PS) Turbo models

Diesel engines: 1.5 (102PS) Turbo D models

Six-speed automatic transmission:

Petrol engines: 1.2 (130PS) Turbo models

Diesel engines: 1.5 (120PS) Turbo D models

Steering

- Speed-sensitive electric power-assisted steering
- Turning circle (wall-to-wall): 11.21m (36.7ft)

Suspension

Front: Independent. Decoupled MacPherson struts with gas-pressure dampers and coil springs. Anti-roll bar.

Rear: Compound crank with coil springs and gas-pressure dampers.

Braking and stability

- Switchable Electronic Stability Programme (ESP)
- Anti-lock Braking System (ABS)
- Corner stability control
- Traction control
- Hill start assist
- Engine drag torque control
- Hydraulic brake assist
- Hydraulic brake boost
- Electronic brakeforce distribution

1.2 (81PS)/1.5 (102PS) Turbo D models

Front ventilated discs: 266mm diameter

Rear discs: 249mm diameter

1.2 (110PS) Turbo/1.2 (130PS) Turbo

Front ventilated discs: 283mm diameter

Rear discs: 249mm diameter

Fuel tank capacity

- 45 litres (9.9 gallons)

Adblue tank capacity

- 14.8 litres (3.2 gallons)

Body

- Aerodynamic drag co-efficient: Cd 0.31

Start/Stop technology

Crossland X's Start/Stop system, fitted as standard to all models, offers real benefits by improving fuel economy and reducing CO₂ emissions, particularly in town. It does this by automatically stopping the engine when you come to a standstill, and then restarting as you prepare to move off.

Before automatically stopping the engine a number of system checks are carried out to ensure that it is both safe and practical to do so.

To ensure safety, the driver must depress the clutch pedal, shift in to neutral, and then release the clutch pedal. System checks carried out before Auto Stop activates include:

- Start/Stop system is not manually deactivated via the facia button
- Sufficient brake vacuum is available to prevent the car rolling down an incline
- Battery is in good condition and charged
- Outside air temperature and engine temperature are above specified minima
- Electronic climate control (where fitted) is not in maximum heating or maximum cooling mode
- Self-cleaning function of the diesel particulate filter is not active

If all of these conditions are satisfied then the vehicle will Auto Stop.

When you are ready to pull away from standstill, Auto Restart is activated by depressing the clutch pedal.

Whilst at a standstill the vehicle is continually monitored. If necessary, the engine will automatically be restarted. Conditions that would initiate an Auto Restart include:

- Low battery level
- Brake vacuum below specified minimum
- Start/Stop system is manually deactivated
- Stationary for 5.5 minutes

Weights and Towing Data kg

	Gross vehicle weight	Maximum towing weights Trailer with brakes (without brakes)
1.2 (83PS)	1690	650 (560)
1.2 (110PS) Turbo	1770	840 (600)
1.2 (110PS) Turbo auto	1805	840 (600)
1.2 (130PS) Turbo	1790	840 (620)
1.2 (130PS) Turbo auto	1835	840 (600)
1.5 (102PS) Turbo D	1820	840 (620)
1.5 (120PS) Turbo D auto	1855	870 (650)

Gross vehicle weight is the total permissible weight of the vehicle including passengers and their luggage. The **maximum roof rack loading** should not exceed 75kg on all models. The **maximum towing weights** are based on the ability of the car, with two occupants of 75kg each, to restart on a 12% gradient, which is approximately 1 in 8.3, at sea level. The permitted trailer load applies up to the specified incline and up to an altitude of 1000 metres above sea level. The permissible gross train weight decreases by 10% for every 1000 metres of additional altitude. Any extra weight, such as luggage or additional passengers, should be deducted from the maximum towing weight. With a trailer fully loaded, **maximum noseweight** should not exceed 75kg. Always fit Vauxhall towing attachments and accessories available from your Vauxhall Retailer. They are designed specifically for Vauxhall models and carry a 12-month guarantee. During trailer towing do not exceed a maximum speed of 60mph. This speed limit is also applicable in countries with higher permitted speeds for trailer-vehicle combinations. Pay attention to the local speed limits. For trailers with low driving stability and caravans the use of an oscillation damper is strongly recommended.

PETROL ENGINES

Engine	1.2 (83PS) with Start/Stop	1.2 (110PS) Turbo with Start/Stop	1.2 (130PS) Turbo with Start/Stop
Capacity	1199cc	1199cc	1199cc
Maximum power	83PS (61kW) @ 5750rpm	110PS (81kW) @ 5500rpm	130PS (96kW) @ 5500rpm
Maximum torque	118Nm (87 lb.ft.) @ 2750rpm	205Nm (151 lb.ft.) @ 1500rpm	230Nm (169 lb.ft.) @ 1750rpm
Configuration	3 cylinders, 4 valves per cylinder, double overhead camshafts	3 cylinders, 4 valves per cylinder, double overhead camshafts	3 cylinders, 4 valves per cylinder, double overhead camshafts
Fuel/induction system	Naturally aspirated with Variable Valve Timing. Multi-point sequential electronic fuel injection	Turbocharger. Variable Valve Timing. Direct fuel injection	Turbocharger. Variable Valve Timing. Direct fuel injection
Emission compliance	Euro 6d	Euro 6d Gasoline Particulate Filter	Euro 6d Gasoline Particulate Filter
Service interval	16,000 miles or 1 year (whichever occurs sooner)	16,000 miles or 1 year (whichever occurs sooner)	16,000 miles or 1 year (whichever occurs sooner)

DIESEL ENGINES

Engine	1.5 (102PS) Turbo D with Start/Stop	1.5 (120PS) Turbo D with Start/Stop
Capacity	1499cc	1499cc
Maximum power	102PS (75kW) @ 3750rpm	120PS (88kW) @ 3750rpm
Maximum torque	250Nm (184 lb.ft.) @ 1750rpm	300Nm (221 lb.ft.) @ 1750rpm
Configuration	4 cylinders, 4 valves per cylinder, double overhead camshafts	4 cylinders, 4 valves per cylinder, double overhead camshafts
Fuel/induction system	Turbocharger. Direct fuel injection	Turbocharger. Direct fuel injection
Emission compliance	Euro 6d Diesel Particulate Filter	Euro 6d Diesel Particulate Filter
Service interval	20,000 miles or 1 year (whichever occurs sooner)	20,000 miles or 1 year (whichever occurs sooner)

ACCESSORIES

CHILD SEATS¹ Total (inc. VAT)

BABY-SAFE ² – 0-13kg/birth to 15 months	£152
– ISOFIX base	£263
DUO ISOFIX ² – 9-18kg/9 months to 4 years	
with top tether kit	£402
KID ² – 15-36kg or 4 to 12 years	£182

SAFETY

Parking sensors	
– four fully flush rear bumper mounted sensors	£353
– four fully flush front bumper mounted sensors ³	£317
Safety Pack – first aid kit, hi-visibility vest and small warning triangle	£30
Warning triangle – Small	£12
Warning triangle – Large	£20
First aid kit	£15
Hi-visibility vest	£9
Fire extinguisher – 2kg	£39

FLEXCONNECT RANGE

FlexConnect bracket	£22
FlexConnect hook	£32
FlexConnect coat hanger	£34
FlexConnect folding table	£77
FlexConnect iPad Mini cradle	£109
FlexConnect iPad (1-4) cradle	£118
FlexConnect iPad Air cradle	£117
FlexConnect Samsung Galaxy cradle	£107

PRACTICAL Total (inc. VAT)

Spare bulb kit ⁴	£39
Stretch tow rope – 3 tonne	£36
Smoker pack	£46
Privacy shades – rear and rear side windows	£104
Side steps	£521

PROTECTION

Rubber floor mats – set of four	£60
Velour floor mats – set of four	£58
Economy floor mats – set of four	£46
Cargo liner ⁵	£78
Cargo net – vertical	£276
Dog guard	£184
Splash guards – front and rear	£118
Load compartment mat	£54

TRANSPORT SYSTEMS Total (inc. VAT)

For roof rails	£197
Without roof rails	£208
Roof carriers (requires base carrier)	
Bike roof carrier – Thule Freeride 532	£78
Surf board roof carrier – Thule 833	£82
Kayak roof carrier – Thule 837	£172
Ski roof carrier (up to 4 pairs)	
– Thule 7324	£161
Ski roof carrier (up to 6 pairs)	
– Thule 7326	£190
Hard shell roof boxes (requires base carrier)	
Thule Ocean 80 (320 litre/1330 x 860 x 370mm)	£154
Thule Ocean 200 (450 litre/1750 x 820 x 450mm)	£323
Thule Motion 800 (460 litre/2050 x 840 x 450mm)	from £463
Thule Touring 200 (400 litre/1750 x 820 x 450mm)	£338
Thule Touring 700 (430 litre/2320 x 700 x 420mm)	£384
Tow bar carrier system	
Fixed tow bar ⁶	from £508
Detachable tow bar ⁶	from £673

STYLING Total (inc. VAT)

Door sill plates	£43
Illuminated door sill plates	£151
Stainless steel pedal covers	
– manual	£118
– automatic	£118

Please note: Prices shown are fully fitted and painted, where applicable and include VAT. Please check with your local Vauxhall Retailer for details. It is advisable to ensure your insurance policy is adequate to cover additional fitted accessories. Prices correct at time of publication.

¹Restrictions apply to the use of child seats, please consult your Vauxhall Retailer or request a copy of the Child seats brochure. ²Without transponder. ³Can only be fitted in conjunction with rear sensors. ⁴Excludes xenon headlight bulb for models with Adaptive Forward Lighting (AFL).

⁵For vehicles without spare wheel. ⁶Available with 7 pin, 13 pin and 12S electrics. Please consult your Vauxhall Retailer for details.

COMPANY CAR DRIVER AND FLEET INFORMATION

High spec, low P11D

As a business and company car driver, you'll find all of our models are seriously fit for fleet; we're talking very low P11D values, generous standard specification and high-tech engines designed for great fuel economy and low emissions – and that's just to get you started.

To get access to even more spec as standard, simply take a step up in the range – low P11D values will continue to apply.

Drivers and businesses all have unique requirements and by taking advantage of low whole-life costs and low company car driver taxation you can get in the driving seat with the spec to suit.

Company Car Driver Free 3 Day Test Drive

Our free* 3 Day Test Drive programme is open to all Company Car Drivers which allows you to choose any model in the current Vauxhall line-up (exclusions apply). With full insurance cover provided, it gives you a meaningful length of time to make an informed decision about your next company car.

Search Vauxhall 3DTD to book your FREE* test drive or click the link the below:

[Vauxhall 3 Day Test Drive](#)

*The free 3 Day Test Drive programme is open to Company Car Drivers and Fleet Decision Makers. Available for UK Mainland only. Terms and conditions apply. Full terms and conditions can be found at vauxhallfleet.co.uk/testdrive/index/terms.

Benefit in kind company car taxation**

The car benefit charge will be the car's list price (including VAT, options and accessories fitted, delivery to Retailer and number plates, but excluding Vehicle Excise Duty and new vehicle first registration fee) multiplied by the percentage charge for the CO₂ emissions band in which the car falls (see table opposite). Multiply this figure by your personal income tax rate (20%[†] for Basic Rate, 40%[†] for Higher Rate) to calculate your annual benefit in kind tax liability.

Example:

Crossland X Business Edition Nav 1.5 (102PS) Turbo D (CO₂ emissions 124g/km)	
On-the-road RRP	£21,450.00
Deduct: Vehicle Excise Duty	(£175.00)
New vehicle first registration fee	(£55.00)
Effective list price	£21,220.00
Add: Optional two-coat metallic paint	£550.00
List price for tax purposes (P11D value)	£21,770.00
Car benefit charge 2020–21 tax year (27%)	£5,878.00
Benefit in kind tax liability (2020–21 tax year)	
Basic Rate (20%) tax payer	£1,175.60
Higher Rate (40%) tax payer	£2,351.20

**Please note this Price Guide provides taxation information as a guide only. Vauxhall does not provide taxation guidance. Drivers should always take professional advice on their own tax position.

[†]Excludes residents of Scotland.

BIK FOR SCOTTISH RESIDENTS

Effective 6 April 2018 the Scottish Government have introduced their own BiK taxation structure. This only applies to Company Car Drivers that are Scottish taxpayers. HMRC will determine whether or not an individual is a Scottish taxpayer based on where their main place of residence is.

The BiK rates for Scotland are:

- Over £12,500–£14,549 Starter Rate 19%
- Over £14,549–£24,994 Basic Rate 20%
- Over £24,994–£43,430 Intermediate Rate 21%
- Over £43,430–£150,000 Higher Rate 41%
- Above £150,000 Top Rate 46%

CO ₂ emissions in grams per kilometre	Percentage of cars price to be taxed	
	Non-Diesel ^{††} 2020-21 tax year	Diesel [†] 2020-21 tax year
Up to 50	12%	–
51–54	13%	–
55–59	14%	–
60–64	15%	–
65–69	16%	–
70–74	17%	–
75–79	18%	22%
80–84	19%	23%
85–89	20%	24%
90–94	21%	25%
95–99	22%	26%
100–104	23%	27%
105–109	24%	28%
110–114	25%	29%
115–119	26%	30%
120–124	27%	31%
125–129	28%	32%
130–134	29%	33%
135–139	30%	34%
140–144	31%	35%
145–149	32%	36%
150–154	33%	37%
155–159	34%	37%
160–164	35%	37%
165–169	36%	37%
170+	37%	37%

Fleet Toolbox

Discover the facts in our online Toolbox for both Company Car Drivers and Fleet Decision Makers. The Fleet Toolbox has a host of useful calculators, comparators, interactive listings and information.

Search Vauxhall Fleet Tools or click the link below: [Vauxhall Fleet Tool Box](#)

Contact Vauxhall Fleet

Please contact one of our dedicated sales teams who will be happy to help with your particular enquiry.

Company Car Drivers

Call: 0345 111 2020

Email: company-car@vauxhallinfo.co.uk

Telephone lines are open

– Monday to Friday 8:00am–9:00pm

– Saturday and Sunday 9:00am–6:00pm

Fleet Decision Makers

Depending on the size of your fleet of vehicles, we have a dedicated team to handle your enquiries. The lines are open Monday to Friday excluding Bank Holidays.

1–24 vehicles

Call: 0845 076 2254 (8:30am–5:00pm)

25+ vehicles

Call: 0330 587 8222 (8:30am–5:00pm)

Email: vauxhallfleet@vauxhall.co.uk

Special Vehicles (Police, Fire and Ambulance)

Call: 01582 409999 (8:30am–5:00pm)

Email: vauxhallspecialvehicles@vauxhall.co.uk

^{††}Also applies to diesel vehicles that meet the Real Driving Emissions Step 2 (RDE2). [†]Applies to vehicles that do not meet the Real Driving Emissions Step 2 (RDE2).

To calculate your own personal liability, search: **Vauxhall BiK**, or click the link below:

[Vauxhall BiK Tool](#)

For more information visit www.vauxhall.co.uk/fleet

FURTHER INFORMATION

On-the-road prices

To eliminate uncertainty about hidden costs when buying a new car, Vauxhall publishes on-the-road recommended retail prices (RRP) and these are shown in the pricing tables within this price guide. These prices include VAT, number plates and delivery to Retailer of £700.00 (including £116.67 VAT), 12 months' Government Vehicle Excise Duty (see opposite for details) and the DVLA new vehicle first registration fee of £55.00.*

Please note: The on-the-road recommended retail price (RRP) does not include fuel supplied by the Retailer, motor insurance or any other goods or services supplied by agreement between the Retailer and the customer.

Price protection

Order a new Vauxhall for build in the current model year (as confirmed by your Retailer) for delivery no more than three months in advance and the price you are quoted is the price you pay. This is irrespective of any subsequent price rises between placing your order and delivery of your new car, but you must take delivery as soon as the car is available. Vauxhall Motors Limited is not liable for price adjustments caused by Government changes in the rate of VAT (currently 20%), Vehicle Excise Duty, DVLA new vehicle first registration fee or by any other applicable legislation or regulations.

In the event of an accident

Vauxhall Accident Management helps keep you mobile following an accident. Benefits include vehicle recovery, Vauxhall-approved repairs and contacting your insurer. For more details, visit www.vauxhall.co.uk/AccidentManagement

Free2Move Lease

Whether you're a big company or a small business looking for vehicle financing, Free2Move Lease, our business finance specialists, can deliver exactly what you need.

Free2Move Lease is one of the UK's largest leasing companies and is also a member of the British Vehicle Rental and Leasing Association (BVRLA).

With over 60,000 vehicles in the Free2Move Lease portfolio, Free2Move Lease is able to offer competitive vehicle solutions. In addition, Free2Move Lease also offer innovative connected management of servicing and maintenance.

For further information, please contact your local Vauxhall Retailer or visit www.vauxhall.co.uk/offers-finance/business-leasing.html

Vehicle Excise Duty

The amount of Vehicle Excise Duty (road fund licence) payable on new cars varies depending on the level of carbon dioxide (CO₂) emissions produced by the vehicle. CO₂ emissions are measured in grams per kilometre (g/km) travelled and divided into 13 charging bands shown in the table opposite.

A 'first year rate' of Vehicle Excise Duty is payable on all new cars and in subsequent years the amount payable reverts to the 'standard rate'. From 1 April 2017 the breakpoints for each of these bands have been revised. Also, for vehicles with a list price over £40,000, including factory-fitted options, an additional £320 is payable for the first five years of standard rate payments.

Vehicle Excise Duty*

Band	CO ₂ emissions in grams per kilometre	First year rate		Standard rate
		Petrol [#]	Diesel [†]	
A	0	£0	£0	£0
B	1-50	£10	£25	£145
C	51-75	£25	£110	£145
D	76-90	£110	£135	£145
E	91-100	£135	£155	£145
F	101-110	£155	£175	£145
G	111-130	£175	£215	£145
H	131-150	£215	£540	£145
I	151-170	£540	£870	£145
J	171-190	£870	£1,305	£145
K	191-225	£1,305	£1,850	£145
L	226-255	£1,850	£2,175	£145
M	Over 255	£2,175	£2,175	£145

*Correct at time of issue.

[#]Also applies to diesel vehicles that meet the Real Driving Emissions Step 2 (RDE2).

[†]Applies to vehicles that do not meet the Real Driving Emissions Step 2 (RDE2).

FURTHER INFORMATION

Customer Care Commitment

For added peace of mind, Vauxhall has an innovative Customer Care Commitment that offers the following:

- Three-year vehicle warranty consisting of a one-year/unlimited mileage manufacturer's warranty and a second and third year manufacturer's warranty with a 60,000 miles limitation
- Vauxhall Assistance for 12 months from first registration
- Six years' body panel anti-perforation warranty

Please note: Warranty is only available on vehicles sourced from Vauxhall Motors Limited. Terms and conditions apply – please see your Vauxhall Retailer for details.

Vauxhall Assistance

Vauxhall Assistance is provided automatically with every new Vauxhall for 12 months from first registration and covers everything from accident assistance, roadside recovery and 'at home' service to flat tyres. With Vauxhall Assistance help is literally just a free* phone call away, 24 hours a day, 365 days a year!

Protecting the environment

Vauxhall's commitment to the environment is demonstrated by our products' many environmental awards. For even more information on Vauxhall's efforts to achieve an environmentally sustainable future, and how to dispose of your end-of-life vehicle, see www.vauxhall.co.uk/recycling

Vauxhall Care

This all-inclusive service package is available on Vauxhalls under 10 months old (from date of first registration).

This package offers complete peace of mind for the first 3 years of your Vauxhall's life with fixed monthly payments for the plan duration.

- **3 years' Vauxhall servicing** – covers first, second and third annual services. Including a brake-fluid change in the second service
- **2 years' Vauxhall Roadside Assistance** – first year from us
- **First years' MOT**** – free of charge by your local Vauxhall Retailer

For full terms and conditions and to sign up, visit: vauxhall.co.uk/vauxhallcare

Vauxhall Service Club

Vauxhall Service Club is available for all Vauxhall owners, and it's free to join. Members benefit from the following:

- 15% off Vauxhall Approved Accessories
- Vauxhall's aged 2-3 Years = 15% off parts and labour
- Vauxhall's aged over 3 Years = 25% off parts and labour
- Half price MOT's (NI excluded)
- Free pre-MOT test inspection (NI only)
- Fixed price AdBlue Refills
 - Car = £14.99
 - Van = £24.99
- Access to the Vauxhall Accident Management Programme
- Online service booking available 24/7 with servicing appointments available within 3 days – [Book Online](#)
- Collection and delivery/onward mobility options
- Complimentary 'Wash and Vac' with all routine services[†]
- Vauxhall trained technicians
- Genuine Vauxhall parts
- Minimum 12 months warranty on parts and labour
- Regular newsletters with exclusive offers, discounts and competitions

Terms and conditions apply. To join visit: vauxhall.co.uk/serviceclub

Vauxhall Insurance with added reassurance

Comprehensive cover – Summary of benefits

- Competitive premiums
- Repairs by a Vauxhall-trained technician
- Genuine Vauxhall parts, guaranteed for five years when we repair your car within our Approved Repairer Network
- Free courtesy car as standard when using an Approved Repairer^{††}
- 24 hour claims helpline
- Personal Accident benefit
- Cover for audio equipment
- Windscreen cover

Call for a quote on **0330 678 1130**[‡]

For more product information

For further information on the Vauxhall range or location of your nearest Vauxhall Retailer please call **0345 600 1500**. Alternatively, details can be found on our website at vauxhall.co.uk

*Mobile phone users will be charged at their standard tariff.

**First years' MOT is not available for Northern Ireland.

[†]Participating Retailers only.

^{††}Should your car need repairing following an accident we provide a courtesy car (subject to availability) for the duration of the repair. Only genuine Vauxhall parts are used. Terms and conditions apply.

[‡]Calls may be recorded. Vauxhall Insurance Services is a trading name of Europa Group Limited which is authorised and regulated by the Financial Conduct Authority. Europa Group Limited's Financial Services Register number 309794. Registered as a limited company in England and Wales No 03279177. Registered Office: Europa House, Midland Way, Thornbury, Bristol, BS35 2JX.

Take the next step:



Join us online:

Discover the full Vauxhall range at [vauxhall.co.uk](https://www.vauxhall.co.uk) >

Privacy Policy: For full details please visit [vauxhall.co.uk/privacy](https://www.vauxhall.co.uk/privacy)

The invoice price, including delivery to Retailer, factory-fitted options, accessories fitted by the Retailer and number plates, is subject to VAT. Some feature descriptions in this guide may refer to, and some illustrations may show, optional equipment not included in the standard delivery. The information contained in this guide was accurate at the time of publication. We reserve the right to make changes in design and equipment. Please note that Vauxhall Retailers are not the agents of Vauxhall Motors Limited and are not authorised to bind Vauxhall Motors Limited by any specific or implied undertaking or representation. It is advisable to ensure that your motor insurance policy provides adequate cover for additional fitted options and accessories. The colours in this guide are only approximate actual colours. Illustrated optional equipment is available at extra charge. Availability, technical features and equipment provided on our vehicles can vary by model. For precise information on the equipment provided on our vehicles, please contact your local Vauxhall Retailer.

GRANDLAND X

INCLUDING NEW HYBRID RANGE

Price and Specification Guide | 5 June 2020 | Model Year 2020.5



VAUXHALL

Range Highlights

Models

Prices

Features/Options

Interior Style and Comfort

Infotainment

Exterior Colours

Wheels and Tyres

Engines and Technical Data

Performance, Economy and Emissions

Specifications

Dimensions and Capacities

Accessories

Company Car Information

Further Information

GRANDLAND X RANGE HIGHLIGHTS

SE PREMIUM

Standard features include:

- R4.0 IntelliLink system
 - Smartphone projection, Apple CarPlay™ and Android Auto™
 - 7-inch colour touchscreen
 - AM/FM/digital radio
 - Bluetooth® connectivity
 - USB connection with iPod control
- Dual-zone electronic climate control
- Cruise control with intelligent speed adaptation
- Leather-covered steering wheel with audio controls
- Steering column adjustable for reach and rake
- Dark-tinted rear windows
- 18-inch diamond-cut technical grey alloy wheels
- Alloy-effect protective front and rear skid plates
- Chrome-effect side window trim
- Auto lighting/windscreen wipers
- Front fog lights
- Switchable electronic stability programme
- Anti-lock braking system
- Six airbags
- Lane departure warning
- LED daytime running lights
- High beam assist
- Front and rear parking distance sensors
- Remote control security alarm system
- LED headlights

BUSINESS EDITION NAV

Features over SE Premium models:

- Navi 5.0 IntelliLink system
 - Fully integrated European sat nav system
 - 8-inch colour touchscreen
 - Voice control
- Ergonomic active front seats
- Ambient lighting
- Versatility Pack
 - Centre rear seat armrest with load-through
 - Illuminated luggage area
 - Flex Floor with under-floor divider
- Alloy-effect door sill covers
- 18-inch multi-spoke silver-effect alloy wheels
- Electrically foldable door mirrors with puddle lights
- Safety Pack
 - Driver drowsiness system
 - Forward collision alert
 - Automatic emergency braking
 - Lane assist
- Side blind spot alert

Please note: Grandland X Business Edition Nav does not feature dark-tinted rear windows.

SRI NAV

Features over Business Edition Nav models:

- Black roof and door mirrors
- Dark-tinted rear windows
- 18-inch diamond-cut technical grey alloy wheels

GRIFFIN

Features over SRi Nav models:

- Keyless entry and start
- Power operated tailgate with foot sensor

Unique to Griffin:

- Front and rear floor mats (front Griffin-branded)
- Griffin badge

ELITE NAV

Features over Business Edition Nav models:

- Leather seat facings
- Power driver's seat
- Heated front seats
- Heated steering wheel
- 19-inch multi-spoke silver alloy wheels
- Panoramic glass roof
- Heated windscreen

ELITE NAV PREMIUM

Features over Elite Nav models:

- Keyless entry and start
- Power operated tailgate with foot sensor

GRANDLAND X HYBRID FEATURE HIGHLIGHTS

SE NAV HYBRID

Standard features include:

- Navi 5.0 IntelliLink system
 - Fully integrated European sat nav, with 8-inch colour touchscreen
 - Voice control
 - Smartphone projection
 - AM/FM/digital radio
 - Bluetooth® connectivity
 - USB connection with iPod control
- Wireless charging for mobile devices
- Dual-zone electronic climate control
- 3D instrument cluster
- Leather, flat bottom steering wheel, with audio controls
- Cruise control
- 230-volt power outlet behind front seats
- 18-inch silver multi-spoke alloy wheels
- Silver-effect roof rails
- Auto lighting/windscreen wipers
- Front fog lights
- Power operated tailgate with foot sensor
- LED headlights
- Electrically adjustable/heated door mirrors
- Electronic stability programme
- Anti-lock braking system
- Safety Pack
 - Driver drowsiness system
 - Forward collision alert
 - Automatic emergency braking
 - Lane assist
- Keyless entry and start
- Lane departure warning
- High beam assist
- Rear parking distance sensors
- Remote control security alarm system
- Front-wheel drive

SRI NAV HYBRID

Features over SE Nav models:

- Driver's ergonomic active front seat
- 19-inch diamond-cut alloy wheels
- Adaptive cruise control
- Black roof and door mirrors
- Dark-tinted rear windows
- Ambient lighting
- Alloy-effect door sill covers
- Alloy-effect protective front and rear skid plates
- Electrically foldable door mirrors with puddle lights
- Side blind spot alert
- Front and rear parking distance sensors
- Front-wheel drive

BUSINESS EDITION NAV HYBRID

High spec as standard with a low P11D price. That's the tax-efficient Business Edition Nav. Specifically developed for businesses and company car drivers alike, its low P11D price combined with ultra-low BiK rates help ensure excellent whole life costs for businesses and reduced BiK taxation for company car drivers.

GRANDLAND X HYBRID4 FEATURE HIGHLIGHTS

SRI NAV HYBRID4

Standard features include:

- Navi 5.0 IntelliLink system
 - Fully integrated European sat nav, with 8-inch colour touchscreen
 - Voice control
 - Smartphone projection
 - AM/FM/digital radio
 - Bluetooth® connectivity
 - USB connection with iPod control
- Wireless charging for mobile devices
- Driver's ergonomic active front seat
- Dual-zone electronic climate control
- 3D instrument cluster
- Leather, flat bottom steering wheel, with audio controls
- Adaptive cruise control
- 230-volt power outlet behind front seats
- 19-inch diamond-cut alloy wheels
- Silver-effect roof rails
- Black roof and door mirrors
- Alloy-effect door sill covers
- Alloy-effect protective front and rear skid plates
- Dark-tinted rear windows
- Auto lighting/windscreen wipers
- Ambient lighting
- Front fog lights
- Power operated tailgate with foot sensor
- LED headlights
- Electrically adjustable/heated door mirrors
- Electrically foldable door mirrors with puddle lights
- Electronic stability programme
- Anti-lock braking system
- Safety Pack
 - Driver drowsiness system
 - Forward collision alert
 - Automatic emergency braking
 - Lane assist
- Keyless entry and start
- Lane departure warning
- High beam assist
- Side blind spot alert
- Front and rear parking distance sensors
- Remote control security alarm system
- All-wheel drive

ELITE NAV HYBRID4

Features over SRi Nav models:

- Heated windscreen
- Leather seat facings
- Heated front seats
- Ergonomic active front seats (AGR-approved*)
- Power driver's seat
- Versatility pack
- All-wheel drive

BUSINESS EDITION NAV PREMIUM HYBRID4

High spec as standard with a low P11D price. That's the tax-efficient Business Edition Nav Premium. Specifically developed for businesses and company car drivers alike, its low P11D price combined with ultra-low BiK rates help ensure excellent whole life costs for businesses and reduced BiK taxation for company car drivers.

ULTIMATE NAV HYBRID4

Features over Elite Nav models:

- Premium audio system
- Premium LED headlights with daytime running lights
- Park and Go Pack
 - Panoramic camera
 - Advanced park assist
 - Semi-automatic steering
- All-wheel drive

SE PREMIUM



VX_GRA_30758.psd

SE PREMIUM OTR from £27,025

Infotainment:

- R4.0 IntelliLink system
 - Apple CarPlay™ and Android Auto™
 - 7-inch colour touchscreen
 - AM/FM/digital radio
 - Bluetooth® connectivity
 - USB connection with iPod control

Interior convenience/styling:

- Dual-zone electronic climate control
- Cruise control with intelligent speed adaptation
- Multi-function trip computer
- Leather-covered steering wheel
- Steering column adjustable for reach and rake
- Steering wheel mounted audio controls
- Driver's centre armrest
- Auto anti-dazzle rear-view mirror
- 60/40 split-folding rear seat

Exterior convenience/styling:

- LED headlights
- Dark-tinted rear windows
- 18-inch diamond-cut alloy wheels
- Alloy-effect protective front and rear skid plates
- Chrome-effect side window trim
- Side-protection mouldings
- Front fog lights
- Auto lighting/windscreen wipers
- Electrically adjustable/heated door mirrors
- Electrically operated front and rear windows
- Remote control central locking

Safety/security:

- Switchable electronic stability programme
- Anti-lock braking system
- Lane departure warning
- Speed sign recognition
- Traction control
- Hill start assist
- Deflation detection system
- Six airbags
- Remote control security alarm system
- Front and rear parking distance sensors
- Emergency tyre inflation kit in lieu of spare wheel
- LED daytime running lights
- High beam assist

This vehicle is covered by our Price Protection Guarantee. See 'Further Information' page for details.

BUSINESS EDITION NAV

**BUSINESS EDITION
NAV**

**OTR from
£24,600**

Infotainment:

- Navi 5.0 IntelliLink system
 - Fully integrated European sat nav system
 - Apple CarPlay™ and Android Auto™
 - 8-inch colour touchscreen
 - AM/FM/digital radio
 - Bluetooth® connectivity
 - Voice control
 - USB connection with iPod control
- Vauxhall Connect

Interior convenience/styling:

- Ergonomic active front seats
- Dual-zone electronic climate control
- Cruise control with intelligent speed adaptation
- Multi-function trip computer
- Leather-covered steering wheel
- Steering column adjustable for reach and rake
- Steering wheel mounted audio controls
- Driver's centre armrest
- Auto anti-dazzle rear-view mirror
- 60/40 split-folding rear seat
- Ambient lighting
- Versatility Pack
 - Centre rear seat armrest with load-through
 - Illuminated luggage area
 - Flex Floor with under-floor divider
- Alloy-effect door sill covers

Exterior convenience/styling:

- LED headlights
- 18-inch silver-effect multi-spoke alloy wheels
- Chrome-effect side window trim
- Alloy-effect protective front and rear skid plates
- Front fog lights
- Auto lighting/windscreen wipers
- Electrically adjustable/heated door mirrors
- Electrically foldable door mirrors with puddle lights
- Electrically operated front and rear windows

Safety/security:

- Switchable electronic stability programme
- Anti-lock braking system
- Safety Pack
 - Driver drowsiness system/Forward collision alert/Automatic emergency braking/Lane assist
- Side blind spot alert
- Lane departure warning
- Speed sign recognition
- Deflation detection system
- Six airbags
- Remote control central locking/alarm system
- Front and rear parking distance sensors
- Emergency tyre inflation kit in lieu of spare wheel
- LED daytime running lights
- High beam assist



VX_GRA_30079.psd

This vehicle is covered by our Price Protection Guarantee. See 'Further Information' page for details.

SRI NAV



VX_GRA_30123.psd

SRI NAV

OTR from £28,230

Infotainment:

- Navi 5.0 IntelliLink system
 - Fully integrated European sat nav system
 - Apple CarPlay™ and Android Auto™
 - 8-inch colour touchscreen
 - AM/FM/digital radio
 - Bluetooth® connectivity
 - Voice control
 - USB connection with iPod control
- Vauxhall Connect

Interior convenience/styling:

- Ergonomic active front seats
- Dual-zone electronic climate control
- Cruise control with intelligent speed adaptation
- Multi-function trip computer
- Leather-covered steering wheel
- Steering column adjustable for reach and rake
- Steering wheel mounted audio controls
- Driver's centre armrest
- Auto anti-dazzle rear-view mirror
- 60/40 split-folding rear seat
- Ambient lighting
- Versatility Pack
 - Centre rear seat armrest with load-through
 - Illuminated luggage area
 - Flex Floor with under-floor divider
- Alloy-effect door sill covers

Exterior convenience/styling:

- LED headlights
- 18-inch diamond-cut alloy wheels
- Black roof and door mirrors
- Dark-tinted rear windows
- Chrome-effect side window trim
- Alloy-effect protective front and rear skid plates
- Front fog lights
- Auto lighting/windscreen wipers
- Electrically adjustable/heated door mirrors
- Electrically foldable door mirrors with puddle lights
- Electrically operated front and rear windows

Safety/security:

- Switchable electronic stability programme
- Anti-lock braking system
- Safety Pack
 - Driver drowsiness system/Forward collision alert/Automatic emergency braking/Lane assist
- Side blind spot alert
- Lane departure warning
- Speed sign recognition
- Deflation detection system
- Six airbags
- Remote control central locking/alarm system
- Front and rear parking distance sensors
- Emergency tyre inflation kit in lieu of spare wheel
- LED daytime running lights
- High beam assist

This vehicle is covered by our Price Protection Guarantee. See 'Further Information' page for details.

GRIFFIN



VX_GRA_30771.psd

GRIFFIN

OTR from £28,855

Infotainment:

- Navi 5.0 IntelliLink system
 - Fully integrated European sat nav system
 - Apple CarPlay™ and Android Auto™
 - 8-inch colour touchscreen
 - AM/FM/digital radio
 - Bluetooth® connectivity
 - Voice control
 - USB connection with iPod control
- Vauxhall Connect

Interior convenience/styling:

- Ergonomic active front seats
- Dual-zone electronic climate control
- Cruise control with intelligent speed adaptation
- Multi-function trip computer
- Leather-covered steering wheel
- Steering column adjustable for reach and rake
- Steering wheel mounted audio controls
- Driver's centre armrest
- Auto anti-dazzle rear-view mirror
- 60/40 split-folding rear seat
- Ambient lighting
- Versatility Pack
 - Centre rear seat armrest with load-through
 - Illuminated luggage area
 - Flex Floor with under-floor divider
- Alloy-effect door sill covers

Exterior convenience/styling:

- LED headlights
- 18-inch diamond-cut alloy wheels
- Black roof and door mirrors
- Dark-tinted rear windows
- Chrome-effect side window trim
- Alloy-effect protective front and rear skid plates
- Front fog lights
- Auto lighting/windscreen wipers
- Electrically adjustable/heated door mirrors
- Electrically foldable door mirrors with puddle lights
- Electrically operated front and rear windows
- Keyless entry and start
- Power operated tailgate with foot sensor

Safety/security:

- Switchable electronic stability programme
- Anti-lock braking system
- Safety Pack
 - Driver drowsiness system/Forward collision alert/Automatic emergency braking/Lane assist
- Side blind spot alert
- Lane departure warning
- Speed sign recognition
- Deflation detection system
- Six airbags
- Remote control central locking/ alarm system
- Front and rear parking distance sensors
- Emergency tyre inflation kit in lieu of spare wheel
- LED daytime running lights
- High beam assist

This vehicle is covered by our Price Protection Guarantee. See 'Further Information' page for details.

ELITE NAV



VX_GRA_30077.psd

ELITE NAV OTR from £29,350

Infotainment:

- Navi 5.0 IntelliLink system
 - Fully integrated European sat nav system
 - Apple CarPlay™ and Android Auto™
 - 8-inch colour touchscreen
 - AM/FM/digital radio
 - Bluetooth® connectivity
 - Voice control
 - USB connection with iPod control
- Vauxhall Connect

Interior convenience/styling:

- Dual-zone electronic climate control
- Ergonomic heated active front seats
- Leather seat facings
- Cruise control with intelligent speed adaptation
- Multi-function trip computer
- Leather-covered heated steering wheel
- Steering column adjustable for reach and rake
- Steering wheel mounted audio controls
- Auto anti-dazzle rear-view mirror
- Driver's centre armrest
- 60/40 split-folding rear seat
- Versatility Pack
 - Centre rear seat armrest with load-through
 - Illuminated luggage area
 - Flex Floor with under-floor divider
- Alloy-effect door sill covers

Exterior convenience/styling:

- LED headlights
- 19-inch multi-spoke silver alloy wheels
- Panoramic glass roof
- Alloy-effect protective front and rear skid plates
- Front fog lights
- Auto lighting/windscreen wipers
- Heated windscreen
- Chrome-effect side window trim
- Electrically adjustable/heated door mirrors
- Electrically foldable door mirrors with puddle light
- Electrically operated front and rear windows

Safety/security:

- Switchable electronic stability programme
- Anti-lock braking system
- Safety Pack
 - Driver drowsiness system/Forward collision alert/Automatic emergency braking/Lane assist
- Side blind spot alert
- Lane departure warning
- Speed sign recognition
- Front camera system
- Traction control/hill start assist
- Deflation detection system
- Six airbags
- Remote control central locking/alarm system
- Front and rear parking distance sensors
- Emergency tyre inflation kit in lieu of spare wheel
- LED daytime running lights

This vehicle is covered by our Price Protection Guarantee. See 'Further Information' page for details.

ELITE NAV PREMIUM

ELITE NAV PREMIUM

OTR from
£29,920

Infotainment:

- Navi 5.0 IntelliLink system
 - Fully integrated European sat nav system
 - Apple CarPlay™ and Android Auto™
 - 8-inch colour touchscreen
 - AM/FM/digital radio
 - Bluetooth® connectivity
 - Voice control
 - USB connection with iPod control
- Vauxhall Connect

Interior convenience/styling:

- Dual-zone electronic climate control
- Ergonomic heated active front seats
- Leather seat facings
- Cruise control with intelligent speed adaptation
- Multi-function trip computer
- Leather-covered heated steering wheel
- Steering column adjustable for reach and rake
- Steering wheel mounted audio controls
- Auto anti-dazzle rear-view mirror
- Driver's centre armrest
- 60/40 split-folding rear seat
- Versatility Pack
 - Centre rear seat armrest with load-through
 - Illuminated luggage area
 - Flex Floor with under-floor divider
- Alloy-effect door sill covers

Exterior convenience/styling:

- LED headlights
- 19-inch multi-spoke silver alloy wheels
- Panoramic glass roof
- Alloy-effect protective front and rear skid plates
- Front fog lights
- Auto lighting/windscreen wipers
- Heated windscreen
- Chrome-effect side window trim
- Electrically adjustable/heated door mirrors
- Electrically foldable door mirrors with puddle light
- Electrically operated front and rear windows
- Keyless entry and start
- Power operated tailgate with foot sensor

Safety/security:

- Switchable electronic stability programme
- Anti-lock braking system
- Safety Pack
 - Driver drowsiness system/Forward collision alert/Automatic emergency braking/Lane assist
- Side blind spot alert
- Lane departure warning
- Speed sign recognition
- Front camera system
- Traction control/hill start assist
- Deflation detection system
- Six airbags
- Remote control central locking/alarm system
- Front and rear parking distance sensors
- Emergency tyre inflation kit in lieu of spare wheel
- LED daytime running lights



VX_GRA_30760.psd

This vehicle is covered by our Price Protection Guarantee. See 'Further Information' page for details.

SE NAV HYBRID



VX_GRA_PHEV_30742psd

SE NAV HYBRID

OTR
£36,700

Infotainment:

- Navi 5.0 IntelliLink system
 - Fully integrated European sat nav system
 - Apple CarPlay™ and Android Auto™
 - 8-inch colour touchscreen
 - AM/FM/digital radio
 - Bluetooth® connectivity
 - Voice control
 - USB connection with iPod control
- Wireless charging for mobile devices
- Vauxhall Connect

Interior convenience/styling:

- Dual-zone electronic climate control
- Cruise control with intelligent speed adaptation
- Multi-function trip computer
- Leather-covered steering wheel
- Steering column adjustable for reach and rake
- Steering wheel mounted audio controls
- Driver's centre armrest
- Auto anti-dazzle rear-view mirror
- 60/40 split-folding rear seat

Exterior convenience/styling:

- LED headlights
- 18-inch silver-effect multi-spoke alloy wheels
- Silver-effect roof rails
- Side-protection mouldings
- Front fog lights
- Auto lighting/windscreen wipers
- Electrically adjustable/heated door mirrors
- Electrically operated front and rear windows
- Remote control central locking

Safety/security:

- Switchable electronic stability programme
- Anti-lock braking system
- Lane departure warning
- Speed sign recognition
- Traction control
- Hill start assist
- Deflation detection system
- Six airbags
- Remote control security alarm system
- Rear parking distance sensors
- Emergency tyre inflation kit in lieu of spare wheel
- LED daytime running lights
- High beam assist

SRI NAV/ BUSINESS EDITION NAV HYBRID



VX_GRA_PHEV_30006.psd

Please note, alloy wheel style may differ from that illustrated, see Wheels and Tyres page for details.

SRI NAV HYBRID

OTR
£38,500

Infotainment:

- Navi 5.0 IntelliLink system
 - Fully integrated European sat nav, with 8-inch colour touchscreen
 - Voice control
 - Smartphone projection
 - AM/FM/digital radio
 - Bluetooth® connectivity
 - USB connection with iPod control
- Wireless charging for mobile devices
- Vauxhall Connect

Interior convenience/styling:

- Driver's ergonomic active front seat
- Dual-zone electronic climate control
- 3D instrument cluster
- Leather, flat bottom steering wheel, with audio controls
- Cruise control with intelligent speed adaptation
- 230-volt power outlet behind front seats
- Alloy-effect door sill covers

Exterior convenience/styling:

- LED headlights
- 19-inch diamond cut alloy wheels
- Silver-effect roof rails
- Black roof and door mirrors
- Dark-tinted rear windows
- Chrome-effect side window trim
- Alloy-effect protective front and rear skid plates

- Auto lighting/windscreen wipers
- Front fog lights
- Power operated tailgate with foot sensor
- LED headlights
- Electrically foldable door mirrors with puddle lights

Safety/security:

- Electronic stability programme
- Anti-lock braking system
- Safety Pack
 - Driver drowsiness system
 - Forward collision alert
 - Automatic emergency braking
 - Lane assist
- Side blind spot alert
- Keyless entry and start
- Lane departure warning
- High beam assist
- Front and rear parking distance sensors
- Remote control security alarm system

BUSINESS EDITION NAV HYBRID

OTR
£32,390

High spec as standard with a low P11D price. That's the tax-efficient Business Edition Nav. Specifically developed for businesses and company car drivers alike, its low P11D price combined with ultra-low BiK rates help ensure excellent whole life costs for businesses and reduced BiK taxation for company car drivers.

SRI NAV HYBRID4



VX_GRA_PHEV_30007.psd

SRI NAV HYBRID4

OTR
£41,500

Infotainment:

- Navi 5.0 IntelliLink system
 - Fully integrated European sat nav, with 8-inch colour touchscreen
 - Voice control
 - Smartphone projection
 - AM/FM/digital radio
 - Bluetooth® connectivity
 - USB connection with iPod control
- Wireless charging for mobile devices
- Vauxhall Connect

Interior convenience/styling:

- Driver's ergonomic active front seat
- Dual-zone electronic climate control
- 3D instrument cluster
- Leather, flat bottom steering wheel, with audio controls
- Cruise control with intelligent speed adaptation
- 230-volt power outlet behind front seats
- Alloy-effect door sill covers

Exterior convenience/styling:

- LED headlights
- 19-inch diamond cut alloy wheels
- Silver-effect roof rails
- Black roof and door mirrors
- Dark-tinted rear windows
- Chrome-effect side window trim
- Alloy-effect protective front and rear skid plates
- Auto lighting/windscreen wipers
- Front fog lights
- Power operated tailgate with foot sensor
- LED headlights
- Electrically foldable door mirrors with puddle lights

Safety/security:

- Electronic stability programme
- Anti-lock braking system
- Safety Pack
 - Driver drowsiness system
 - Forward collision alert
 - Automatic emergency braking
 - Lane assist
- Side blind spot alert
- Keyless entry and start
- Lane departure warning
- High beam assist
- Front and rear parking distance sensors
- Remote control security alarm system

ELITE NAV/ BUSINESS EDITION NAV PREMIUM HYBRID4



VX_GRA_PHEV_30006.psd

Please note, alloy wheel style may differ from that illustrated, see Wheels and Tyres page for details.

ELITE NAV HYBRID4

OTR
£43,400

Infotainment:

- Navi 5.0 IntelliLink system
 - Fully integrated European sat nav, with 8-inch colour touchscreen
 - Voice control
 - Smartphone projection
 - AM/FM/digital radio
 - Bluetooth® connectivity
 - USB connection with iPod control
- Wireless charging for mobile devices
- Vauxhall Connect

Interior convenience/styling:

- Ergonomic active front seats
- Leather seat facings
- Heated front seats
- Driver 8-way electrical seat, with 2-way headrest, memory and ventilation function
- Dual-zone electronic climate control
- 3D instrument cluster
- Leather, flat bottom steering wheel, with audio controls
- Cruise control with intelligent speed adaptation
- 230-volt power outlet behind front seats
- Versatility pack
- Alloy-effect door sill covers

Exterior convenience/styling:

- LED headlights
- 19-inch diamond cut alloy wheels
- Heated windscreen
- Silver-effect roof rails
- Black roof and door mirrors
- Dark-tinted rear windows

- Alloy-effect protective front and rear skid plates
- Auto lighting/windscreen wipers
- Front fog lights
- Power operated tailgate with foot sensor
- Electrically foldable door mirrors with puddle lights

Safety/security:

- Electronic stability programme
- Anti-lock braking system
- Safety Pack
 - Driver drowsiness system
 - Forward collision alert
 - Automatic emergency braking
 - Lane assist
- Side blind spot alert
- Keyless entry and start
- Lane departure warning
- High beam assist
- Front and rear parking distance sensors
- Remote control security alarm system

BUSINESS EDITION NAV PREMIUM HYBRID4

OTR
£36,790

High spec as standard with a low P11D price. That's the tax-efficient Business Edition Nav Premium. Specifically developed for businesses and company car drivers alike, its low P11D price combined with ultra-low BiK rates help ensure excellent whole life costs for businesses and reduced BiK taxation for company car drivers.

ULTIMATE NAV HYBRID4



VX_GRA_PHEV_30008.psd

ULTIMATE EDITION NAV HYBRID4

OTR
£46,650

Infotainment:

- Premium audio system
- Navi 5.0 IntelliLink system
 - Fully integrated European sat nav, with 8-inch colour touchscreen
 - Voice control
 - Smartphone projection
 - Bluetooth® connectivity
- Wireless charging for mobile devices
- Vauxhall Connect

Interior convenience/styling:

- Automatic cruise control
- Alloy-effect sports pedals
- Leather seat facings
- Heated front seats
- Driver 8-way electrical seat, with 2-way headrest, memory and ventilation function
- Dual-zone electronic climate control
- 3D instrument cluster
- Leather, flat bottom steering wheel, with audio controls
- 230-volt power outlet behind front seats
- Versatility pack
- Alloy-effect door sill covers

Exterior convenience/styling:

- Premium LED headlights with daytime running lights
- 19-inch diamond cut alloy wheels
- Silver-effect roof rails
- Dark-tinted rear windows
- Power operated tailgate with foot sensor
- Heated windscreen
- Black roof and door mirrors
- Alloy-effect protective front and rear skid plates
- Auto lighting/windscreen wipers
- Front fog lights
- Electrically foldable door mirrors with puddle lights

Safety/security:

- Keyless entry and start
- Park and Go Pack
 - Panoramic camera
 - Advanced park assist
 - Semi-automatic steering
- Safety Pack
 - Driver drowsiness system
 - Forward collision alert
 - Automatic emergency braking
 - Lane assist
- Side blind spot alert
- Keyless entry and start
- Lane departure warning
- High beam assist
- Remote control security alarm system

GRANDLAND X PRICES

	Pack Code	Fuel Type	Price (£)	VAT (£)	Total (£)	On-the-road RRP (£)	Financial Year 2020/21 BiK 20% (£)	WLTP Combined CO ₂ (g/km)* - pack code	Insurance Groups
SE PREMIUM									
1.2 (130PS) Turbo	2D75 EP6P	Petrol	21,712.50	4,342.50	26,055.00	27,025.00	142.68	146	20E
1.2 (130PS) Turbo auto	2D75 EF8P	Petrol	23,229.17	4,645.83	27,875.00	29,170.00	157.15	151	21E
1.5 (130PS) Turbo D	2D75 HG6P	Diesel	23,020.83	4,604.17	27,625.00	28,595.00	141.62	136	21E
1.5 (130PS) Turbo D auto	2D75 HD8P	Diesel	24,520.83	4,904.17	29,425.00	30,395.00	150.62	136	21E
BUSINESS EDITION NAV									
1.2 (130PS) Turbo	2E75 EP6T	Petrol	19,691.67	3,938.33	23,630.00	24,600.00	129.75	147	14E
1.2 (130PS) Turbo auto	2E75 EF8T	Petrol	21,208.33	4,241.67	25,450.00	26,745.00	143.82	152	14E
1.5 (130PS) Turbo D	2E75 HG6T	Diesel	20,991.67	4,198.33	25,190.00	26,160.00	129.43	137	15E
1.5 (130PS) Turbo D auto	2E75 HD8T	Diesel	22,491.67	4,498.33	26,990.00	27,960.00	138.43	137	15E
SRI NAV									
1.2 (130PS) Turbo	2E75 EP6S	Petrol	22,716.67	4,543.33	27,260.00	28,230.00	149.12	146	15E
1.2 (130PS) Turbo auto	2E75 EF8S	Petrol	24,233.33	4,846.67	29,080.00	30,375.00	163.78	151	15E
1.5 (130PS) Turbo D	2E75 HG6S	Diesel	24,025.00	4,805.00	28,830.00	29,800.00	147.63	137	15E
1.5 (130PS) Turbo D auto	2E75 HD8S	Diesel	25,525.00	5,105.00	30,630.00	31,600.00	156.63	136	15E
GRIFFIN									
1.2 (130PS) Turbo	2E75 EP6G	Petrol	23,237.50	4,647.50	27,885.00	28,855.00	152.45	147	17E
1.2 (130PS) Turbo auto	2E75 EF8G	Petrol	24,754.17	4,950.83	29,705.00	31,000.00	167.22	151	17E
1.5 (130PS) Turbo D	2E75 HG6G	Diesel	24,545.83	4,909.17	29,455.00	30,425.00	150.77	137	17E
1.5 (130PS) Turbo D auto	2E75 HD8G	Diesel	26,045.83	5,209.17	31,255.00	32,225.00	159.77	136	17E

Grandland X's petrol and diesel engines meet the Real Driving Emissions Step 2 (RDE2) standards.

WLTP Combined CO₂ (g/km) figures, valid 3 March 2020, are based on a configured vehicle as per pack code for UK with no options fitted.

*Fuel consumption and CO₂ figures are determined according to the WLTP test cycle. CO₂ figures, BiK values and RRP pricing shown above are for a standard vehicle without any additional optional equipment. CO₂ figures are used to calculate Vehicle Excise Duty (VED) for the first registration of the vehicle and BiK. The addition of optional extras could increase the certified CO₂ emission output. This in turn may affect the amount of VED payable upon registration, and, for company car drivers, the P11D value and the amount of Benefit in Kind (BiK) tax payable. Figures shown are for comparison purposes and should only be compared to the fuel consumption and CO₂ values of other cars tested to the same technical standard. The fuel consumption achieved, and CO₂ produced, in real world conditions will depend upon a number of factors including, but not limited to: the accessories fitted (pre and post registration); variations in weather; driving styles and vehicle load. The WLTP (Worldwide Harmonised Light Vehicles Test Procedure) is used to measure fuel consumption and CO₂ figures. Full data relating to WLTP test cycles can be found at: www.vauxhall.co.uk/wltp

Please note: On-the-road recommended retail prices (RRP) include number plates and delivery to Retailer of £700.00 (inc. £116.67 VAT), 12 months' Vehicle Excise Duty and new vehicle first registration fee of £55.00. Excludes fuel and insurance. Company Car Benefit in Kind (BiK) rates are monthly based on the standard paint price.

GRANDLAND X PRICES

	Pack Code	Fuel Type	Price (£)	VAT (£)	Total (£)	On-the-road RRP (£)	Financial Year 2020/21 BiK 20% (£)	WLTP Combined CO ₂ (g/km)* - pack code	Insurance Groups
ELITE NAV									
1.2 (130PS) Turbo	2E75 EP6E	Petrol	23,650.00	4,730.00	28,380.00	29,350.00	155.08	147	14E
1.2 (130PS) Turbo auto	2E75 EF8E	Petrol	25,166.67	5,033.33	30,200.00	31,495.00	169.93	152	14E
1.5 (130PS) Turbo D	2E75 HG6E	Diesel	24,950.00	4,990.00	29,940.00	30,910.00	153.18	138	15E
1.5 (130PS) Turbo D auto	2E75 HD8E	Diesel	26,450.00	5,290.00	31,740.00	32,710.00	162.18	137	15E
ELITE NAV PREMIUM									
1.2 (130PS) Turbo	2E75 EP6F	Petrol	24,125.00	4,825.00	28,950.00	29,920.00	158.12	147	17E
1.2 (130PS) Turbo auto	2E75 EF8F	Petrol	25,641.67	5,128.33	30,770.00	32,065.00	173.08	152	17E
1.5 (130PS) Turbo D	2E75 HG6F	Diesel	25,425.00	5,085.00	30,510.00	31,480.00	156.03	138	17E
1.5 (130PS) Turbo D auto	2E75 HD8F	Diesel	26,925.00	5,385.00	32,310.00	33,280.00	165.03	137	17E

Grandland X's petrol and diesel engines meet the Real Driving Emissions Step 2 (RDE2) standards.

WLTP Combined CO₂ (g/km) figures, valid 3 March 2020, are based on a configured vehicle as per pack code for UK with no options fitted.

*Fuel consumption and CO₂ figures are determined according to the WLTP test cycle. CO₂ figures, BiK values and RRP pricing shown above are for a standard vehicle without any additional optional equipment. CO₂ figures are used to calculate Vehicle Excise Duty (VED) for the first registration of the vehicle and BiK. The addition of optional extras could increase the certified CO₂ emission output. This in turn may affect the amount of VED payable upon registration, and, for company car drivers, the P11D value and the amount of Benefit in Kind (BiK) tax payable. Figures shown are for comparison purposes and should only be compared to the fuel consumption and CO₂ values of other cars tested to the same technical standard. The fuel consumption achieved, and CO₂ produced, in real world conditions will depend upon a number of factors including, but not limited to: the accessories fitted (pre and post registration); variations in weather; driving styles and vehicle load. The WLTP (Worldwide Harmonised Light Vehicles Test Procedure) is used to measure fuel consumption and CO₂ figures. Full data relating to WLTP test cycles can be found at: www.vauxhall.co.uk/wltp

Please note: On-the-road recommended retail prices (RRP) include number plates and delivery to Retailer of £700.00 (inc. £116.67 VAT), 12 months' Vehicle Excise Duty and new vehicle first registration fee of £55.00. Excludes fuel and insurance. Company Car Benefit in Kind (BiK) rates are monthly based on the standard paint price.

GRANDLAND X HYBRID RANGE PRICES

	Pack Code	Fuel Type	Price (£)	VAT (£)	Total (£)	On-the-road RRP (£)	Financial Year 2020/21 BiK 20% (£)	WLTP Combined CO ₂ (g/km) [#] - pack code	Insurance Groups
HYBRID									
SE NAV									
1.6 (225PS) Turbo/Electric	92D75 ID8A	Petrol/Electric	29,954.17	5,990.83	35,945.00	36,700.00	61.07	31	24E
SRI NAV									
1.6 (225PS) Turbo/Electric	92E75 ID8S	Petrol/Electric	31,454.17	6,290.83	37,745.00	38,500.00	64.07	31	24E
BUSINESS EDITION NAV									
1.6 (225PS) Turbo/Electric	92E75 ID8B	Petrol/Electric	26,362.50	5,272.50	31,635.00	32,390.00	53.88	31	23E
HYBRID4									
SRI NAV									
1.6 (300PS) Turbo/Electric	92E75 IC8S	Petrol/Electric	33,954.17	6,790.83	40,745.00	41,500.00	69.07	29	30E
BUSINESS EDITION NAV PREMIUM									
1.6 (300PS) Turbo/Electric	92E75 IC8C	Petrol/Electric	30,029.17	6,005.83	36,035.00	36,790.00	61.22	29	29E
ELITE NAV									
1.6 (300PS) Turbo/Electric	92E75 IC8E	Petrol/Electric	35,537.50	7,107.50	42,645.00	43,400.00	72.23	29	30E
ULTIMATE NAV									
1.6 (300PS) Turbo/Electric	92U75 IC8Y	Petrol/Electric	38,245.83	7,649.17	45,895.00	46,650.00	77.65	29	32E

OPTION	Price (£) exc. VAT	Price (£) inc. VAT
7.4kW on-board charger (1 phase) – halves charging time when charging with a 7kW wallbox (see Hybrid Specifications for further details)	£416.67	£500.00

WLTP Combined CO₂ (g/km) figures, valid 3 March 2020, are based on a configured vehicle as per pack code for UK with no options fitted.

[#]Fuel consumption and CO₂ figures are determined according to the WLTP test cycle. CO₂ figures, BiK values and RRP pricing shown above are for a standard vehicle without any additional optional equipment. CO₂ figures are used to calculate Vehicle Excise Duty (VED) for the first registration of the vehicle and BiK. The addition of optional extras could increase the certified CO₂ emission output. This in turn may affect the amount of VED payable upon registration, and, for company car drivers, the P11D value and the amount of Benefit in Kind (BiK) tax payable. Figures shown are for comparison purposes and should only be compared to the fuel consumption and CO₂ values of other cars tested to the same technical standard. The fuel consumption achieved, and CO₂ produced, in real world conditions will depend upon a number of factors including, but not limited to: the accessories fitted (pre and post registration); variations in weather; driving styles and vehicle load. The WLTP (Worldwide Harmonised Light Vehicles Test Procedure) is used to measure fuel consumption and CO₂ figures. Full data relating to WLTP test cycles can be found at: www.vauxhall.co.uk/wltp

Please note: On-the-road recommended retail prices (RRP) include number plates and delivery to Retailer of £700.00 (inc. £116.67 VAT), 12 months' Vehicle Excise Duty and new vehicle first registration fee of £55.00. Excludes fuel and insurance. Company Car Benefit in Kind (BiK) rates are monthly based on the standard paint price.

SAFETY

STANDARD FEATURES – The following features are standard across the entire Grandland X range, including hybrid models.

Airbags

- Driver's airbag
- Front passenger's airbag
- Front seat side-impact airbags
- Full-size curtain airbags for driver, front seat passenger and outer rear seat passengers

Seating

- Height-adjustable front seat head restraints
- Height-adjustable rear seat head restraints
- Anti-submarining ramps in front seats

Seatbelts

- Inertia-reel lap and diagonal seatbelts for all seats
- Dual seatbelt pretensioners on front seats – these keep the pelvis better coupled to the vehicle in an impact; the pelvis and therefore the legs are allowed less forward movement, reducing the risk of hard knee contact with the fascia
- Pretensioners on outer rear seatbelt retractors
- Load limiters on outer rear seatbelt retractors
- Smart seatbelt reminder for front and rear seats – warning lights and audible warning

Braking

- Anti-lock Braking System (ABS)
- Hill start assist
- Hydraulic brake assist
- Electronic brakeforce distribution

Tyre pressure

- Deflation detection system

Child safety

- Deactivation switch for front passenger's front and side-impact airbags – permits the safe use of a child seat in the front passenger seat
- i-Size compatible child seat mountings located on front passenger's seat and outer rear seats (does not include child seat). Rear seat mountings incorporate top tether anchor points – allows i-Size child safety seats to be securely fixed into the car. The mounting system reduces forward movement in an accident and makes the child seat easier to install
- Child-proof locks on rear doors

Stability

- Switchable Electronic Stability Programme (ESP)

Additional ESP features

- Corner stability control
- Traction control
- Engine drag torque control – Improves directional stability by preventing the driven wheels from locking on slippery surfaces under the influence of engine braking

Driver/passenger safety

- Energy-absorbing steering column
- Side-impact protection beam
- Reinforced passenger safety cell
- Deformation zones front and rear

Pedestrian safety

- Collapsible windscreen wiper system – designed to reduce pedestrian head injuries
- Upper and lower bumper design – reduces upper and lower leg injuries



Hill start assist.



ISOFIX child seat mountings.



Automatic emergency braking.

DRIVER ASSISTANCE

STANDARD FEATURES – The following features are standard across the entire Grandland X Petrol/Diesel range. Specific features by model are outlined in the separate tabular information.

Cruise control with speed limiter and intelligent speed adaptation

With steering wheel mounted controls. Enables you to maintain a constant speed, making it ideal for economical motorway driving.

Lane departure warning

If the driver has not actively steered or signalled, the lane departure warning system warns when the car moves outside of lane markings at speeds above 37mph.

- Warning light in instrument cluster
- Audible warning
- Facia on/off switch

Automatically tilting door mirrors

Door mirrors automatically tilt downwards when reverse gear is selected to improve visibility of the back of the car.

Speed sign recognition

Detects and then displays speed limits, reducing uncertainty and the risk of speeding.

- Recognises different speed signs, including temporary speed restrictions
- Displays reminder in the instrument cluster
- On Nav models, where the front camera system is unable to detect any speed signs the speed limit stored in the navigation database will be displayed

Electric parking brake

Centre console switch in lieu of handbrake lever.

Steering

- Speed-sensitive electric power-assisted steering

Vauxhall driver assistance systems are intended to support the driver within the system-imminent limitations. The driver remains responsible for the driving task at all times.

MODEL SPECIFIC FEATURES/OPTION

PETROL/DIESEL MODELS	SE Premium	Business Edition Nav	SRi Nav	Griffin	Elite Nav	Elite Nav Premium
Rain-sensitive windscreen wipers	●	●	●	●	●	●
Side blind spot alert		●	●	●	●	●
Safety Pack – Driver drowsiness system/Forward collision alert/Automatic emergency braking/Lane assist		●	●	●	●	●
Front and rear parking distance sensors	●	●	●	●	●	●
Tech Pack – Advance park assist/Rear-view camera/Premium LED Adaptive Forward Lighting	£1,765	£1,765	£1,765		£1,765	£1,765

DRIVER INFORMATION AND SECURITY

STANDARD FEATURES – The following features are standard across the entire Grandland X Petrol/Diesel range. Specific features by model are outlined in the separate tabular information.

Driver Information

Instrumentation

- Speedometer and rev counter
- Fuel gauge with low fuel level warning light
- Water temperature gauge with warning light
- Shift-up indication light (manual models only)
 - Indicates when to change gear for optimum fuel economy

Driver information display (centrally located in instrument cluster)

- Displays trip computer data
- Total mileage
- Service-due indicator
- Deflation detection system
- 3.5-inch colour information display

Multi-function trip computer (displayed on driver information display)

- Trip mileage
- Vehicle range based on remaining fuel
- Average speed
- Average fuel economy
- Instantaneous fuel economy

Central facia display (format dependent on infotainment unit)

- Audio information
- Digital clock with automatic RDS time adjustment
- Outside air temperature with ice warning function
- Additional features dependent on infotainment unit (see infotainment for details)

Security

- Remote control security alarm system (operates in conjunction with central locking)
- Electronically protected audio equipment
- Engine deadlock immobiliser
- Visible Vehicle Identification Number (VIN)
- Locking wheel nuts
- Remote control central door locking
- Two folding keys with integral remote
- Luggage compartment cover

MODEL SPECIFIC FEATURE/OPTION

PETROL/DIESEL MODELS	SE Premium	Business Edition Nav	SRI Nav	Griffin	Elite Nav	Elite Nav Premium
SECURITY						
Remote control central locking	●	●	●	●	●	●
Keyless entry/engine start/stop inc. power tailgate		£710	£710	●		●

CONVENIENCE

STANDARD FEATURES – The following features are standard across the entire Grandland X Petrol/Diesel range. Specific features by model are outlined in the separate tabular information.

Interior convenience

- Front 12-volt electrical accessory socket
- 12-volt electrical accessory socket in luggage compartment
- Front and rear passenger assist handles
- Automatically dimming anti-dazzle rear-view mirror
- Interior courtesy lighting operated by door switches
- Ventilated glovebox with lid
- Front door pockets with 2.6-litre capacity
- Two drinks holders in centre console
- Rear door pockets with 1.8-litre capacity
- Covered storage compartment in centre console and in driver's armrest
- Luggage compartment foldable cover

Heating and ventilation

- Electronic climate control incorporating air conditioning
- Dual-zone control – Allowing different temperature settings for driver and front passenger
- Advanced predictive logic control system using a sun sensor
- Charcoal filter – Removes dust, airborne particles, pollen and unpleasant odours
- Automatic air direction and fan speed with manual override
- Illuminated controls
- Four adjustable facia vents
- Windscreen demist vents
- Side window demist vents
- Rear passenger compartment heating ducts
- Heated rear screen with timed cut-off

Exterior convenience

- Sound-absorbing windscreen
- Tinted windows
- Electrically operated front and rear windows with safety autoreverse and one-touch facility
- Heated rear window
- Twin electrically adjustable/heated door mirrors (wide-angle on driver's side) with automatic timed cut-off
- Two-speed windscreen wipers with variable intermittent wipe
- Intermittent rear window wash/wipe

MODEL SPECIFIC FEATURES/OPTION

PETROL/DIESEL MODELS	SE Premium	Business Edition Nav	SRi Nav	Griffin	Elite Nav	Elite Nav Premium
INTERIOR CONVENIENCE						
Driver's and front passenger's sunvisors with vanity mirrors	●					
Driver's and front passenger's sunvisors with illuminated vanity mirrors		●	●	●	●	●
Versatility Pack – 60/40 split-folding rear seat/Centre rear armrest/Illuminated luggage area/Flex Floor with under-floor divider		●	●	●	●	●
230-volt accessory socket	£120	£120	£120		£120	£120
Premium lighting – Ambient centre console downlighter/Ambient lighting in front doors/Rear reading lights		●	●	●	●	●
Storage pocket on front seat backs		●	●	●	●	●
Wireless charger for mobile devices	£180	£180	£180		£180	£180

CONVENIENCE

MODEL SPECIFIC FEATURES/OPTIONS

PETROL/DIESEL MODELS	SE Premium	Business Edition Nav	SRi Nav	Griffin	Elite Nav	Elite Nav Premium
HEATING AND VENTILATION						
Winter Pack – Heated front seats/Heated steering wheel/ Heated windscreen	£460	£460	£460		●	●
EXTERIOR CONVENIENCE						
Manually foldable door mirrors	●					
Electrically foldable door mirrors with puddle light		●	●	●	●	●
Dark tinted rear windows	●	£275	●	●	£275	£275
Fixed panoramic glass roof panel with electrically operated sunblind (not available in conjunction with silver-effect roof rails)	£695	£695	£695		●	●
Roof rails, silver-effect (not available in conjunction with fixed panoramic glass roof panel)	£150	£150	£150			
Roof rails, silver-effect, in lieu of fixed panoramic glass roof panel					(£200)	(£200)
Power tailgate – Fitted as part of Keyless entry and start. Not available separately		£710	£710	●		●

EXTERIOR STYLE AND LIGHTING

STANDARD FEATURES – The following features are standard across the entire Grandland X Petrol/Diesel range. Specific features by model are outlined in the separate tabular information.

Exterior styling

- Side-protection mouldings
- Chrome-effect front grille bar
- Body-colour door mirrors
- Body-colour door handles
- Rear spoiler

Exterior lighting

- LED headlights
- LED daytime running lights
- Automatic lighting control
- Lights-on audible warning
- LED tail lights
- High-level centre rear brake light

- Front and rear fog lights
- Reversing light
- Hazard warning lights
- Door-to-door illumination
- Welcome lighting

MODEL SPECIFIC FEATURES/OPTIONS

PETROL/DIESEL MODELS	SE	Business Edition Nav	SRI Nav	Griffin	Elite Nav	Elite Nav Premium
EXTERIOR STYLING						
Alloy-effect protective front and rear skid plates	●	●	●	●	●	●
Chrome-effect side window upper trim	●	●	●	●	●	●
Gloss black B-pillars		●	●	●	●	●
Black roof and door mirrors (not available with Diamond Black exterior colour) – Includes dark-tinted rear windows		£675	●	●	£675	£675
EXTERIOR LIGHTING						
LED headlights with manual beam levelling and high beam assist	●	●	●	●	●	●
Premium LED Adaptive Forward Lighting		□	□		□	□

□ = Available as part of optional extra-cost Tech Pack.

DRIVER ASSISTANCE

STANDARD FEATURES – The following features are standard across the entire Grandland X Hybrid range. Specific features by model are outlined in the separate tabular information.

Cruise control with speed limiter and intelligent speed adaptation

With steering wheel mounted controls. Enables you to maintain a constant speed, making it ideal for economical motorway driving.

Front camera system

A range of class-leading driver assistance and safety features are controlled by the front camera system.

Automatic emergency braking

The system warns you if approaching a vehicle too fast and automatically brakes as a fail-safe.

Forward collision alert

The system operates automatically from 3mph and gives an audible warning as well as a visual warning when approaching another vehicle too quickly.

Lane departure warning with lane assist

If the driver has not actively steered or signalled, the lane departure warning system warns when the car moves outside of lane markings at speeds above 37mph.

- Warning light in instrument cluster
- Audible warning
- Facia on/off switch

Automatically tilting door mirrors

Door mirrors automatically tilt downwards when reverse gear is selected to improve visibility of the back of the car.

Driver drowsiness system

The system monitors driving time and driving behaviour to help prevent accidents caused by tiredness.

Speed sign recognition

Detects and then displays speed limits, reducing uncertainty and the risk of speeding.

- Recognises different speed signs, including temporary speed restrictions
- Displays reminder in the instrument cluster
- On Nav models, where the front camera system is unable to detect any speed signs the speed limit stored in the navigation database will be displayed

Electric parking brake

Centre console switch in lieu of handbrake lever.

MODEL SPECIFIC FEATURES

	HYBRID			HYBRID 4			
	SE Nav Hybrid	SRi Nav Hybrid	Business Edition Nav Hybrid	SRi Nav Hybrid4	Elite Nav Hybrid4	Business Edition Nav Premium Hybrid4	Ultimate Nav Hybrid4
Rain-sensitive windscreen wipers	●	●	●	●	●	●	●
Automatic cruise control with speed limiter and intelligent speed adaptation		●	●	●	●	●	●
Side blind spot alert		●	●	●	●	●	●
Rear parking distance sensors	●						
Front and rear parking distance sensors		●	●	●	●	●	●
Park and Go Pack – Panoramic camera/Advanced park assist/Semi-automatic steering							●

DRIVER INFORMATION AND SECURITY

STANDARD FEATURES – The following features are standard across the entire Grandland X Hybrid range.

Driver Information

Instrumentation

- Speedometer and rev counter
- Fuel gauge with low fuel level warning light
- Water temperature gauge with warning light

Driver information display (centrally located in instrument cluster)

- 3D instrument cluster
- Service-due indicator
- Deflation detection system
- 3.5-inch colour information display

EV information display

- Powerflow display – Informs drivers on the current state of charge and what is being used as the power source, petrol or electric
- Charge display – displays an image of the charge port with the corresponding LED charge indication lights

- e-Save – enables the driver to determine how much battery energy needs to be conserved to ensure that the vehicle reaches its destination when in a zero emission zone. There are three options:
 - 6 mile range reserve
 - 12 mile range reserve
 - Maximum reserve
- Statistics – The Statistics display the average consumption data over a period of time using colour coded graphs.
- Green: Energy recovered by braking phases and partial recharging by the petrol engine (kWh/mile)
- Blue: Energy consumed by the vehicle directly by the battery (kWh/mile)
- Orange: Fuel consumption (mpg)

Multi-function trip computer (displayed on driver information display)

- Trip mileage
- Vehicle range based on remaining fuel
- Average speed
- Average fuel economy
- Instantaneous fuel economy

Central facia display (format dependent on infotainment unit)

- Audio information
- Digital clock with automatic RDS time adjustment
- Outside air temperature with ice warning function
- Additional features dependent on infotainment unit (see infotainment for details)

Security

- Remote control security alarm system (operates in conjunction with central locking)
- Electronically protected audio equipment
- Engine deadlock immobiliser
- Visible Vehicle Identification Number (VIN)
- Locking wheel nuts
- Remote control central door locking
- Luggage compartment cover
- Keyless entry/engine start/start



3D instrument cluster



Vehicle charge display

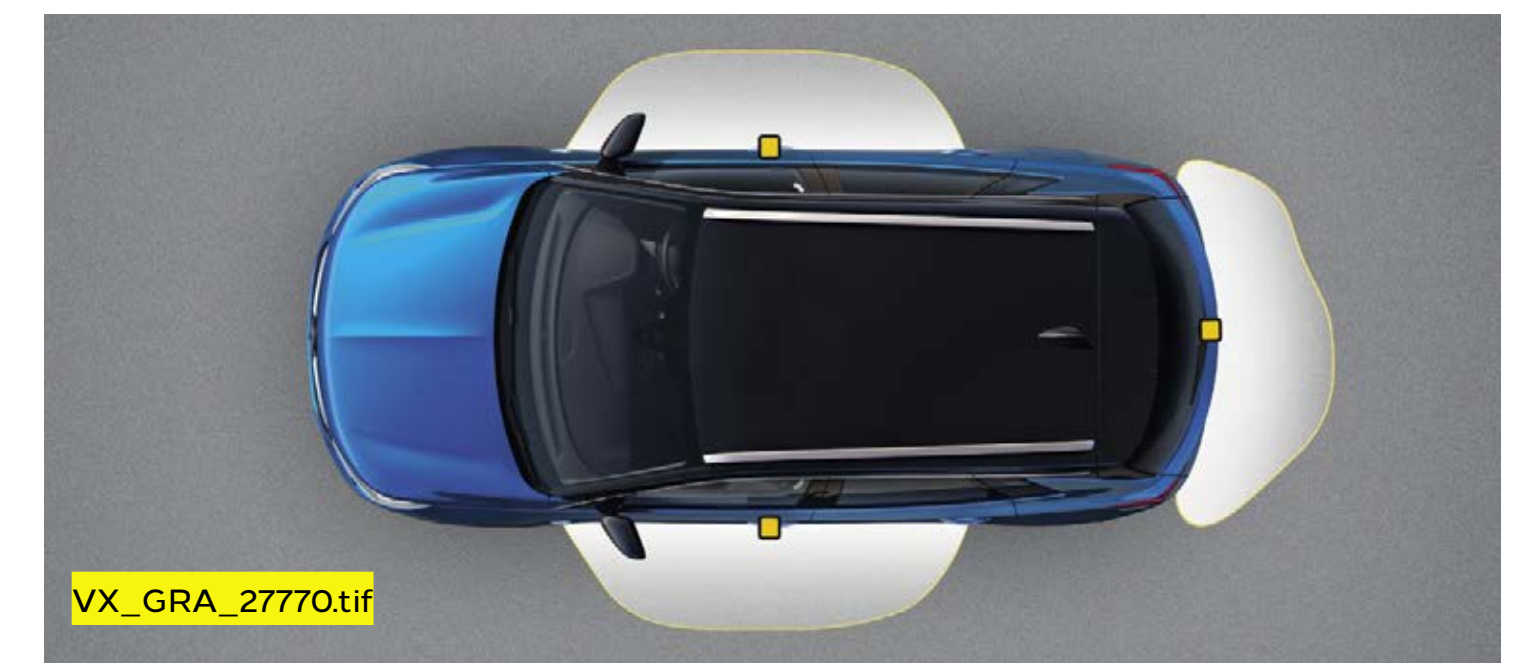

Keyless entry/engine start/stop

CONVENIENCE

STANDARD FEATURES – The following features are standard across the entire Grandland X Hybrid range. Specific features by model are outlined in the separate tabular information.

Interior convenience

- Front 12-volt electrical accessory socket
- 12-volt electrical accessory socket in luggage compartment
- Front and rear passenger assist handles
- 230-volt accessory socket
- Automatically dimming anti-dazzle rear-view mirror
- Interior courtesy lighting operated by door switches
- Ventilated glovebox with lid
- Front door pockets with 2.6-litre capacity
- Two drinks holders in centre console
- Rear door pockets with 1.8-litre capacity
- Covered storage compartment in centre console and in driver's armrest
- Luggage compartment foldable cover
- Wireless charger for mobile devices

Heating and ventilation

- Electronic climate control incorporating air conditioning
- Dual-zone control – Allowing different temperature settings for driver and front passenger
- Advanced predictive logic control system using a sun sensor
- Charcoal filter – Removes dust, airborne particles, pollen and unpleasant odours
- Automatic air direction and fan speed with manual override
- Illuminated controls
- Four adjustable facia vents
- Windscreen demist vents
- Side window demist vents
- Rear passenger compartment heating ducts
- Heated rear screen with timed cut-off

Exterior convenience

- Sound-absorbing windscreen
- Tinted windows
- Electrically operated front and rear windows with safety autoreverse and one-touch facility
- Heated rear window
- Twin electrically adjustable/heated door mirrors (wide-angle on driver's side) with automatic timed cut-off
- Two-speed windscreen wipers with variable intermittent wipe
- Intermittent rear window wash/wipe
- Remote control central door locking
- Power operated tailgate with foot sensor
- Roof rails, silver-effect (not available in conjunction with sunroof)

MODEL SPECIFIC FEATURES

	HYBRID			HYBRID 4			
	SE Nav Hybrid	SRi Nav Hybrid	Business Edition Nav Hybrid	SRi Nav Hybrid4	Elite Nav Hybrid4	Business Edition Nav Premium Hybrid4	Ultimate Nav Hybrid4
INTERIOR CONVENIENCE							
Driver's and front passenger's sunvisors with vanity mirrors	●						
Driver's and front passenger's sunvisors with illuminated vanity mirrors		●	●	●	●	●	●
Ambient lighting		●	●	●	●	●	●
EXTERIOR CONVENIENCE							
Manually foldable and heated door mirrors	●						
Electrically foldable door mirrors with puddle light		●	●	●	●	●	●
Heated windscreen					●	●	●
Dark tinted rear windows		●	●	●	●	●	●

EXTERIOR STYLE AND LIGHTING

STANDARD FEATURES

Exterior styling

- Silver-effect roof rails
- Side-protection mouldings
- Chrome-effect front grille bar
- Body-colour door handles
- Rear spoiler
- Hidden exhaust pipe

Exterior lighting

- LED headlights and daytime running lights
- Automatic lighting
- Lights-on audible warning
- LED tail lights
- High-level centre rear brake light
- Front and rear fog lights

- Reversing light
- Automatic hazard warning lights
- Door-to-door illumination
- Welcome lighting

MODEL SPECIFIC FEATURES/OPTION

	HYBRID			HYBRID 4			
	SE Nav Hybrid	SRi Nav Hybrid	Business Edition Nav Hybrid	SRi Nav Hybrid4	Elite Nav Hybrid4	Business Edition Nav Premium Hybrid4	Ultimate Nav Hybrid4
EXTERIOR STYLING							
Alloy-effect protective front and rear skid plates		●	●	●	●	●	●
Chrome-effect side window upper trim		●	●	●	●	●	●
Body-colour roof and door mirrors	●						
Black roof and door mirrors		●	●	●	●	●	●
Black bonnet				£400	£400	£400	£400
EXTERIOR LIGHTING							
Premium LED headlights							●

INTERIOR STYLING AND COMFORT

SE NAV AND SE PREMIUM MODELS



Steering wheel:

- Three-spoke design
- Leather-covered
- Satin chrome-effect bezel

Facia and door trim:

- Frosted silver facia and door panel inserts
- Black door panels with black Modene cloth inserts
- Chrome-effect interior door handles

Seat trim:

- Berson black fabric seat trim inserts
- Modene black fabric side bolsters

Seating:

- Cloth front seats
- Driver's seat (eight-way adjustable):
 - Height
 - Reach
 - Backrest
 - Head restraint
- Front passenger's seat (six-way adjustable):
 - Reach
 - Backrest
 - Head restraint

BUSINESS EDITION NAV MODELS



Steering wheel:

- Three-spoke design
- Leather-covered
- Satin chrome-effect bezel

Facia and door trim:

- Toba grey facia and door panel inserts (with black trim)
- Sanora gold facia and door panel inserts (with medium atmosphere trim)
- Black door panels with black premium leather-effect inserts
- Chrome-effect interior door handles
- Alloy-effect front door sill covers

Seat trim:

- Harlekin black fabric seat trim inserts
- Black premium leather-effect side bolsters

Seating:

- Ergonomic active front seats – Driver's only on Hybrid models (AGR-approved*)
- Driver's and front passenger's seats (16-way adjustable):
 - Height
 - Reach
 - Tilt (electrical)
 - Backrest
 - Seat cushion extension
 - Lumbar adjustment (four-way electrical)
 - Head restraint
- 60/40 split-folding rear seat back

*AGR (The Campaign for Healthier Backs) is an independent centre of excellence for ergonomics, based in Germany.

INTERIOR STYLING AND COMFORT

SRI NAV AND GRIFFIN MODELS



Steering wheel:

- Three-spoke design
- Leather-covered
- Satin chrome-effect bezel

Facia and door trim:

- Toba grey facia and door panel inserts (with black trim)
- Sanora gold facia and door panel inserts (with medium atmosphere trim)
- Black door panels with black premium leather-effect inserts
- Chrome-effect interior door handles
- Alloy-effect front door sill covers

Seat trim:

- Harlekin black fabric seat trim inserts
- Black premium leather-effect side bolsters

Seating:

- Ergonomic active front seats – Driver's only on Hybrid models (AGR-approved*)
- Driver's and front passenger's seats (16-way adjustable):
 - Height
 - Reach
 - Tilt (electrical)
 - Backrest
 - Seat cushion extension
 - Lumbar adjustment (four-way electrical)
 - Head restraint
- 60/40 split-folding rear seat back

ELITE NAV, ELITE NAV PREMIUM, BUSINESS EDITION NAV PREMIUM AND ULTIMATE NAV MODELS



Steering wheel:

- Three-spoke design
- Leather-covered heated flat-bottom
- Satin chrome-effect bezel

Facia and door trim:

- Toba grey facia and door panel inserts
- Black door panels with black premium leather-effect inserts
- Chrome-effect interior door handles
- Alloy-effect front door sill covers

Seat trim:

- Black Siena perforated leather seat trim inserts
- Black Siena leather side bolsters

Seating:

- Heated front seats
- Ergonomic active front seats (AGR-approved*) and power driver's seat
- Driver's seat (16-way adjustable):
 - Height (electrical)
 - Reach (electrical)
 - Tilt (electrical)
 - Backrest (electrical)
 - Seat cushion extension
 - Lumbar adjustment (four-way electrical)
 - Head restraint
 - Active ventilation
- Front passenger's seat (16-way adjustable):
 - Height
 - Reach
 - Tilt (electrical)
 - Backrest
 - Seat cushion extension
 - Lumbar adjustment (four-way electrical)
 - Head restraint
 - Active ventilation
- 60/40 split-folding rear seat back

*AGR (The Campaign for Healthier Backs) is an independent centre of excellence for ergonomics, based in Germany.

INFOTAINMENT

STANDARD FEATURES

R4.0 INTELLILINK TOUCHSCREEN INFOTAINMENT SYSTEM

STANDARD ON SE PREMIUM MODELS

Onboard features:

- 7-inch colour touchscreen
- Digital radio/AM/FM stereo radio
- RDS with Traffic Programme

Media connections:

- USB connection with iPod control and smartphone projection
- Bluetooth® A2DP audio streaming (Advanced Audio Distribution Profile)

Mobile phone portal:

- Bluetooth® connectivity
- Handsfree calls via steering wheel controls
- Vehicle microphone
- Phone book access – contacts/last calls/missed calls etc. are mirrored on IntelliLink's display and are easily navigated using the touchscreen (features dependent on mobile phone)

Smartphone interface:

- Apple CarPlay™
- Android Auto™

Aerial:

- Rod antenna

Speakers:

- Six (four front, two rear)

NAVI 5.0 INTELLILINK TOUCHSCREEN NAVIGATION AND INFOTAINMENT SYSTEM

STANDARD ON BUSINESS EDITION NAV, SRI NAV,
GRIFFIN, ELITE NAV AND ELITE NAV PREMIUM MODELS

STANDARD ON ALL HYBRID/HYBRID4 MODELS

Onboard features:

- 8-inch colour touchscreen
- Digital radio/AM/FM stereo radio
- RDS with Traffic Programme • Embedded voice control

Navigation features:

- USB connection with iPod control and smartphone projection
- Satellite navigation system • 3D street level mapping
- European coverage

Media connections:

- Two USB connections, front with iPod control and smartphone projection functions
- Bluetooth® A2DP audio streaming (Advanced Audio Distribution Profile)

Mobile phone portal:

- Bluetooth® connectivity
- Handsfree calls via steering wheel controls
- Vehicle microphone
- Phone book access – Contacts/last calls/missed calls etc. are mirrored on IntelliLink's display and are easily navigated using the touchscreen (features dependent on mobile phone)

Smartphone interface:

- Apple CarPlay™ • Android Auto™

Aerial:

- Shark fin

Speakers:

- Six (four front, two rear)



EXTERIOR COLOURS

White Jade(G2o)*
Brilliant paint



VX_GRA_27708.psd

Quartz Grey (G4i)†
Two-coat metallic paint £600



VX_GRA_27710.psd

Moonstone Grey (G4o)†
Two-coat metallic paint £600



VX_GRA_27711.psd

Diamond Black (G1o)**
Two-coat metallic paint £600



VX_GRA_27712.psd

Dark Ruby Red (GEO)**
Two-coat premium paint £710



VX_GRA_27714.psd

Topaz Blue (GAN)**
Two-coat premium paint £710



VX_GRA_27716.psd

Pearl White (G1o)†
Tri-coat premium paint £870





VX_GRA_27717.psd

The colours reproduced may vary slightly from the actual paint colour. As a result they should be used as a guide only. Your Vauxhall Retailer has a comprehensive display of our paint samples.

*Standard exterior paint. **Optional at extra cost. †Optional at extra cost. Not available on Griffin models.



Please note, model shown for colour illustrative purposes only.

WHEELS AND TYRES

PETROL/DIESEL MODELS		SE Premium	Business Edition Nav	SRi Nav	Griffin	Elite Nav	Elite Nav Premium
 VX_GRA_27743_PZW.tif	18-inch multi-spoke silver-effect alloy wheels 225/55 R 18 tyres. Emergency tyre inflation kit (in lieu of spare wheel).	No-cost option	●	No-cost option			
 VX_GRA_27745_RQH.tif	18-inch diamond-cut technical grey five-spoke alloy wheels 225/55 R 18 tyres. Emergency tyre inflation kit (in lieu of spare wheel).	●		●	●		
 VX_GRA_30285_RT6.tif	19-inch multi-spoke silver alloy wheels 235/50 R 19 tyres. Emergency tyre inflation kit (in lieu of spare wheel).					●	●
	Emergency 18-inch steel spare wheel*	£110	£110	£110	£110	£110	£110

*Not available on hybrid models.

WHEELS AND TYRES

		SE Nav Hybrid	Hybrid/Hybrid4 (exc. SE Nav)
 <p>VX_GRA_27743_PZW.tif</p>	<p>18-inch multi-spoke silver-effect alloy wheels 225/55 R 18 tyres. Emergency tyre inflation kit (in lieu of spare wheel).</p>	●	
 <p>VX_GRA_30285_RT6.tif</p>	<p>19-inch multi-spoke silver alloy wheels* 235/50 R 19 tyres. Emergency tyre inflation kit (in lieu of spare wheel).</p>		●
 <p>VX_GRA_30925_RBM.tif</p>	<p>19-inch bi-colour diamond-cut multi-spoke alloy wheels** 235/50 R 19 tyres. Emergency tyre inflation kit (in lieu of spare wheel).</p>		●

*Alloy wheel shown features on initial launch stock. **Alloy wheel shown features on vehicles built from November 2019.

PETROL ENGINE

	1.2 (130PS) Turbo
Capacity	1199cc
Maximum power	130PS (96kW) @ 5500rpm
Maximum torque	230Nm (169 lb.ft.) @ 1750rpm
Configuration	3 cylinders, 4 valves per cylinder, double overhead camshafts
Fuel/induction system	Turbocharger. Variable Valve Timing. Common rail direct injection
Emission compliance	Euro 6d
Service interval	16,000 miles or 1 year (whichever occurs sooner)

DIESEL ENGINE

	1.5 (130PS) Turbo D
Capacity	1499cc
Maximum power	130PS (96kW) @ 3750rpm
Maximum torque	300Nm (221 lb.ft.) @ 1750rpm
Configuration	4 cylinders, 4 valves per cylinder, double overhead camshafts
Fuel/induction system	Turbocharger with intercooler. Common rail direct injection
Emission compliance	Euro 6d Diesel Particulate Filter
Service interval	20,000 miles or 1 year (whichever occurs sooner)

PETROL ENGINES

	1.6 (225hp) Direct Injection Turbo/Electric FWD	1.6 (300hp) Direct Injection Turbo/Electric AWD
Maximum power	180hp (133kW) @ 6000rpm	200hp (147kW) @ 6000rpm
Combined power output	225hp (165kW)	300hp (221kW)
Maximum torque	300Nm (221 lb.ft.) @ 3000rpm	300Nm (221 lb.ft.) @ 3000rpm
Combined torque	360Nm (265lb.ft.)	520Nm (383lb.ft.)
Combined CO₂ emissions (WLTP)#	31g/km	29g/km
Combined fuel economy (WLTP)#	192 mpg (1.5 l/100km)	204 mpg (1.4 l/100km)
Maximum speed/electric only	140/84 mph	146/84 mph
0-60mph	8.6 secs	5.9 secs
Configuration	4 cylinders, 4 valves per cylinder, double overhead camshafts	4 cylinders, 4 valves per cylinder, double overhead camshafts
Fuel/induction system	Turbocharger. Variable Valve Timing. Common rail direct injection	Turbocharger. Variable Valve Timing. Common rail direct injection
Emission compliance	Euro 6d-TEMP	Euro 6d-TEMP

These figures were obtained using a combination of battery power and fuel. The Grandland X Hybrid is a plug-in hybrid vehicle requiring mains electricity for charging.

#WLTP Figures shown are for comparison purposes and should only be compared to the fuel consumption, CO₂ values and electric range of other cars tested to the same technical standard. The fuel consumption and electric range achieved, and CO₂ produced, in real world conditions will depend upon a number of factors including, but not limited to: the accessories fitted (pre and post registration); charging frequency; battery condition; variations in weather; driving styles and vehicle load. For more information contact your local Vauxhall Retailer.

ELECTRIC ENGINES

	Electric motor FWD	Electric motor AWD
Maximum power – front axle	110hp (81.2kW) @ 2500rpm	110hp (81.2kW) @ 2500rpm
Maximum power – rear axle	-	113hp (83kW) @ 1400rpm
Maximum torque – front axle	320Nm (236lb.ft.) @ 500-2500rpm	320Nm (236lb.ft.) @ 500-2500rpm
Maximum torque – rear axle	-	166Nm (122lb.ft.) @ 0-4760rpm
Autonomy (Electric-only range)	34 miles (WLTP)#	35 miles (WLTP)#
Battery capacity	13.2kWh	13.2kWh
Electric energy consumption (Combined)	16.1kWh/100km (WLTP)	15.9kWh/100km (WLTP)
Charging times – Standard cable (Mode 3)	3h 30min @ 3.7kW (16A)	3h 30min @ 3.7kW (16A)
Charging times – Optional on-board charger	1h 45min @ 7.4kW (32A)	1h 45min @ 7.4kW (32A)

Insurance Groups	SE Nav Hybrid	SRi Nav Hybrid	Business Edition Nav Hybrid	SRi Nav Hybrid4	Elite Nav Hybrid4	Business Edition Nav Premium Hybrid4	Ultimate Nav Hybrid4
1.6 (225hp) FWD	24E	24E	23E	-	-	-	-
1.6 (300hp) AWD	-	-	-	30E	30E	29E	32E

These figures were obtained using a combination of battery power and fuel. The Grandland X Hybrid is a plug-in hybrid vehicle requiring mains electricity for charging.

#WLTP Figures shown are for comparison purposes and should only be compared to the fuel consumption, CO₂ values and electric range of other cars tested to the same technical standard. The fuel consumption and electric range achieved, and CO₂ produced, in real world conditions will depend upon a number of factors including, but not limited to: the accessories fitted (pre and post registration); charging frequency; battery condition; variations in weather; driving styles and vehicle load. For more information contact your local Vauxhall Retailer.

PERFORMANCE, FUEL ECONOMY AND EMISSIONS

	Performance (manufacturer's figures)		Fuel economy mpg (litres/100km)#		CO ₂ emissions g/km#		Vehicle Excise Duty*		BiK rates from - 2020/21 tax year
	Maximum speed (mph)	Acceleration 0-60mph (sec)	Combined Low	Combined High	Combined Low	Combined High	First year rate	Standard rate	
1.2 (130PS) Turbo	117	9.5	42.2 (6.6)	45.6 (6.7)	141	152	£215	£145	32%
1.2 (130PS) Turbo auto	122	9.8	40.4 (7.0)	42.8 (6.6)	149	158	£540	£145	33%
1.5 (130PS) Turbo D	119	10.2	48.7 (5.8)	54.3 (5.2)	136	151	£215	£145	30%
1.5 (130PS) Turbo D auto	119	9.9	48.7 (5.8)	54.3 (5.2)	136	151	£215	£145	30%

WEIGHTS AND TOWING DATA^{kg}

	Gross vehicle weight	Maximum towing weights Trailer with brakes (without brakes)
1.2 (130PS) Turbo	1900	1400 (685)
1.2 (130PS) Turbo auto	2000	1300 (696)
1.5 (130PS) Turbo D	2000	1500 (715)
1.5 (130PS) Turbo D auto	2000	1300 (727)
1.6 (300hp) Direct Injection Turbo/Electric AWD†	2350	1250 (600)

#Figures shown are for comparison purposes and should only be compared to the fuel consumption and CO₂ values of other cars tested to the same technical standard. The fuel consumption achieved, and CO₂ produced, in real world conditions will depend upon a number of factors including, but not limited to: the accessories fitted (pre and post registration); variations in weather; driving styles and vehicle load. The WLTP (Worldwide Harmonised Light Vehicles Test Procedure) is used to measure fuel consumption and CO₂ figures. The CO₂ figures display a range to reflect the highest value for the highest emitting version with all available options added, through to a minimum value to represent the lowest emitting version in standard specification.

*Correct at time of publication.

Please note: Gross vehicle weight is the total permissible weight of the vehicle including passengers and their luggage. The maximum roof rack loading should not exceed 70kg. The maximum towing weights are based on the ability of the car, with two occupants of 75kg each, to restart on a 12% gradient, which is approximately 1 in 8.3, at sea level. The permitted trailer load applies up to the specified incline and up to an altitude of 1000 metres above sea level. The permissible gross train weight decreases by 10% for every 1000 metres of additional altitude. At altitudes above 1500 metres, the engine output may drop with a corresponding reduction in towing capability. Any extra weight, such as luggage or additional passengers, should be deducted from the maximum towing weight. With a trailer fully loaded, **maximum noseweight** should not exceed 75kg. Always fit Vauxhall towing attachments and accessories available from your Vauxhall Retailer. They are designed specifically for Vauxhall models and carry a 12-month guarantee. During trailer towing do not exceed a maximum speed of 60mph. This speed limit is also applicable in countries with higher permitted speeds for trailer-vehicle combinations. Pay attention to the local speed limits. For trailers with low driving stability and caravans the use of an oscillation damper is strongly recommended.

SPECIFICATIONS

Start/Stop technology

Grandland X's Start/Stop system, fitted as standard to all models, offers real benefits by improving fuel economy and reducing CO₂ emissions, particularly in town. It does this by automatically stopping the engine when you come to a standstill, and then restarting as you prepare to move off.

Before automatically stopping the engine a number of system checks are carried out to ensure that it is both safe and practical to do so. To ensure safety, the driver must depress the clutch pedal, shift in to neutral, and then release the clutch pedal. System checks carried out before Auto Stop activates include:

- Start/Stop system is not manually deactivated via the facia button
- Sufficient brake vacuum is available to prevent the car rolling down an incline
- Battery is in good condition and charged
- Outside air temperature and engine temperature are above specified minima
- Electronic climate control (where fitted) is not in maximum heating or maximum cooling mode
- Self-cleaning function of the diesel particulate filter is not active

If all of these conditions are satisfied then the vehicle will Auto Stop.

When you are ready to pull away from standstill, Auto Restart is activated by depressing the clutch pedal.

Whilst at a standstill the vehicle is continually monitored. If necessary, the engine will automatically be restarted. Conditions that would initiate an Auto Restart include:

- Low battery level
- Brake vacuum below specified minimum
- Start/Stop system is manually deactivated
- Stationary for 5.5 minutes

Fuel tank capacity

- 53 litres (11.6 gallons)

Adblue tank capacity

- 17 litres (3.7 gallons)

Transmissions

Six-speed manual gearbox:
Standard on all models.

Eight-speed automatic transmission:
Available at extra cost on all models.

Steering

- Speed-sensitive electric power-assisted steering

Suspension

Front: Independent. Decoupled MacPherson struts with gas-pressure dampers and coil springs.
Anti-roll bar.

Rear: Compound crank with coil springs and gas-pressure dampers.

Braking and stability

- Switchable Electronic Stability Programme (ESP)
- Anti-lock Braking System (ABS)
- Corner stability control
- Traction control
- Hill start assist
- Hydraulic brake assist
- Electronic brakeforce distribution

All models

Front ventilated discs: 304mm diameter
Rear discs: 268mm diameter

Insurance Groups	SE Premium	Business Edition Nav	SRi Nav	Griffin	Elite Nav	Elite Nav Premium
1.2 (130PS)	20E	14E	15E	17E	14E	17E
1.2 (130PS) auto	21E	14E	15E	17E	14E	17E
1.5 (130PS) Turbo D	21E	15E	15E	17E	15E	17E
1.5 (130PS) Turbo D auto	21E	15E	15E	17E	15E	17E

SPECIFICATIONS*

Electrified Transmission

The 8-speed electrified transmission system is standard and offers both smooth transition between gears. The 8-speed electrified gearbox includes the following content:

- Multi-disc wet clutch replaces removed torque convertor
- Permanent electric motor that transforms electric energy into mechanical drive energy
- Electric motor installed into the gearbox and petrol engine
- Comes with intuitive and stylish Automatic gearbox with electric shifter with shift paddles

Drive Mode Selector

The Drive Mode selector is positioned next to the Automatic gearbox with electric shifter and enables drivers to select one of the following:

- Hybrid is the default mode and offers the best of both worlds between controlled fuel consumption and on-road performance
- On Hybrid4 models AWD activates the engine and electric engine to provide AWD and improve grip on rough surfaces
- Sport Mode, draws on the combined power of the engine and motor for a more dynamic drive
- Electric activates the electric engine only, for zero CO₂ emissions and complete silence

All-Wheel Drive Electrified Rear Axle

The Electrified Rear Axle is exclusive on the Hybrid4 AWD drivetrain and includes the following:

- Additional power of 80 kW and torque boost of 166 Nm for 10 seconds

- Contains an electric motor, inverter and reducer
- Rear axle cross member modified by an electrified multi-arm axle

Fuel tank capacity

- 43 litres (9.4 gallons)

Weights

Kerbweight: 1800kg

Charging

- Grandland X Hybrid range comes fitted with a Mode 3, 7.4kW cable and a 3.7kW on-board charger as standard.
- A 7.4kW on-board charger can be purchased as an option for £500 inc VAT.

This option halves the vehicle charging time when charging with a 7kW wallbox.

Please note: A Mode 2 cable (standard UK socket*) would charge the vehicle in less than 8 hours.

Grandland X Hybrid range charging time examples are listed showing times dependant on the various powers of charge point which the vehicle is plugged into.



VX_GRA_PHEV_29853.tif

On-board charger	Charge point		
	3.7kW AC (1 Phase)	7kW AC (1 Phase)	11kW AC (3 Phase)
3.7kW (1 phase) - Standard	3 ½ hours	3 ½ hours	3 ½ hours
7.4kW (1 phase) - Optional	3 ½ hours	1 ¾ hours	3 ½ hours

Preliminary data determined according to WLTP test procedure methodology. EG type approval and Certificate of Conformity are not yet available. Preliminary values may differ from official final type approval data. Charging rate depends on power source and charging cable used.

*Only use a domestic electrical socket that has been checked by a qualified electrician and is protected by a circuit breaker adapted to the amperage of the electrical circuit.

DIMENSIONS AND CAPACITIES

All measurements in mm (inches) unless stated otherwise.

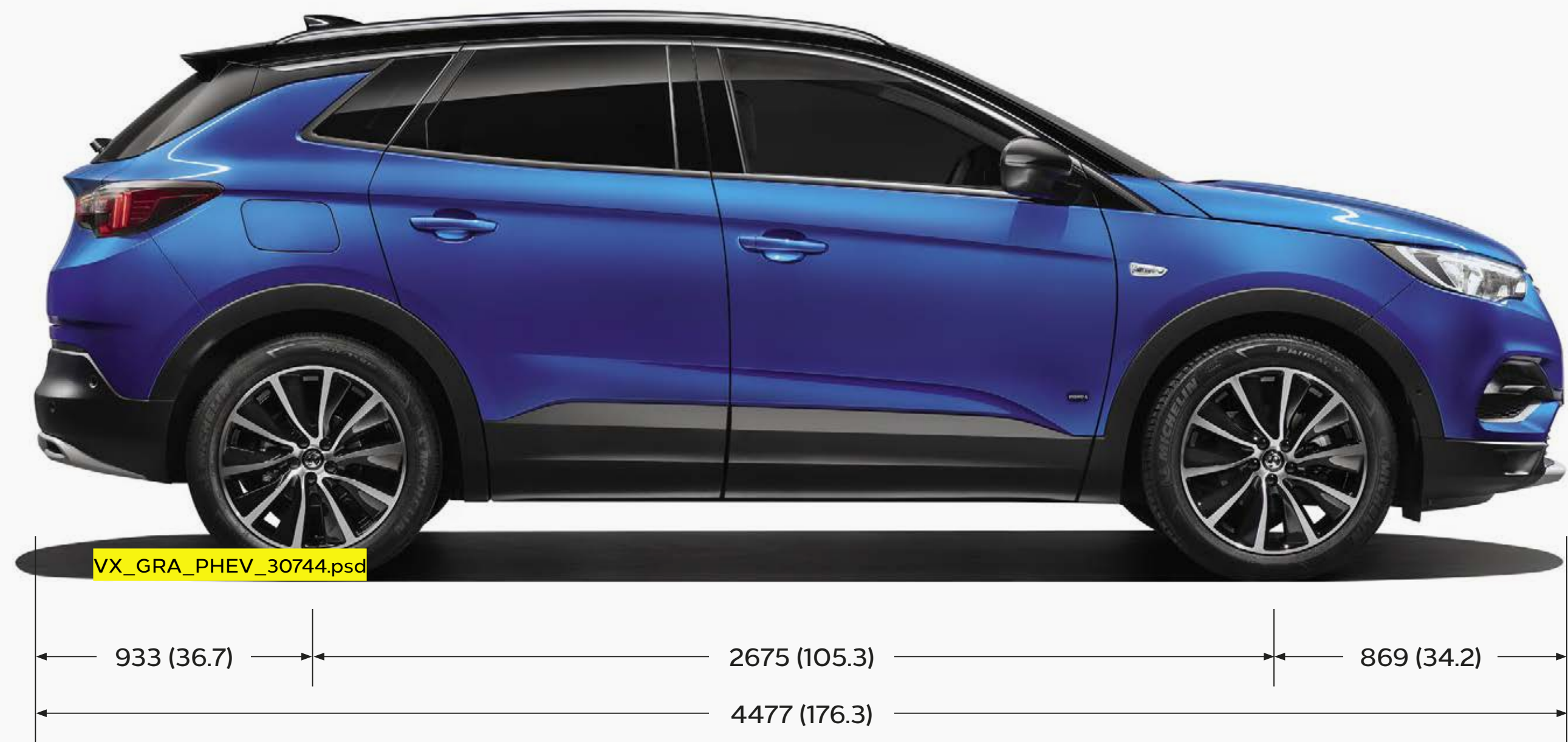
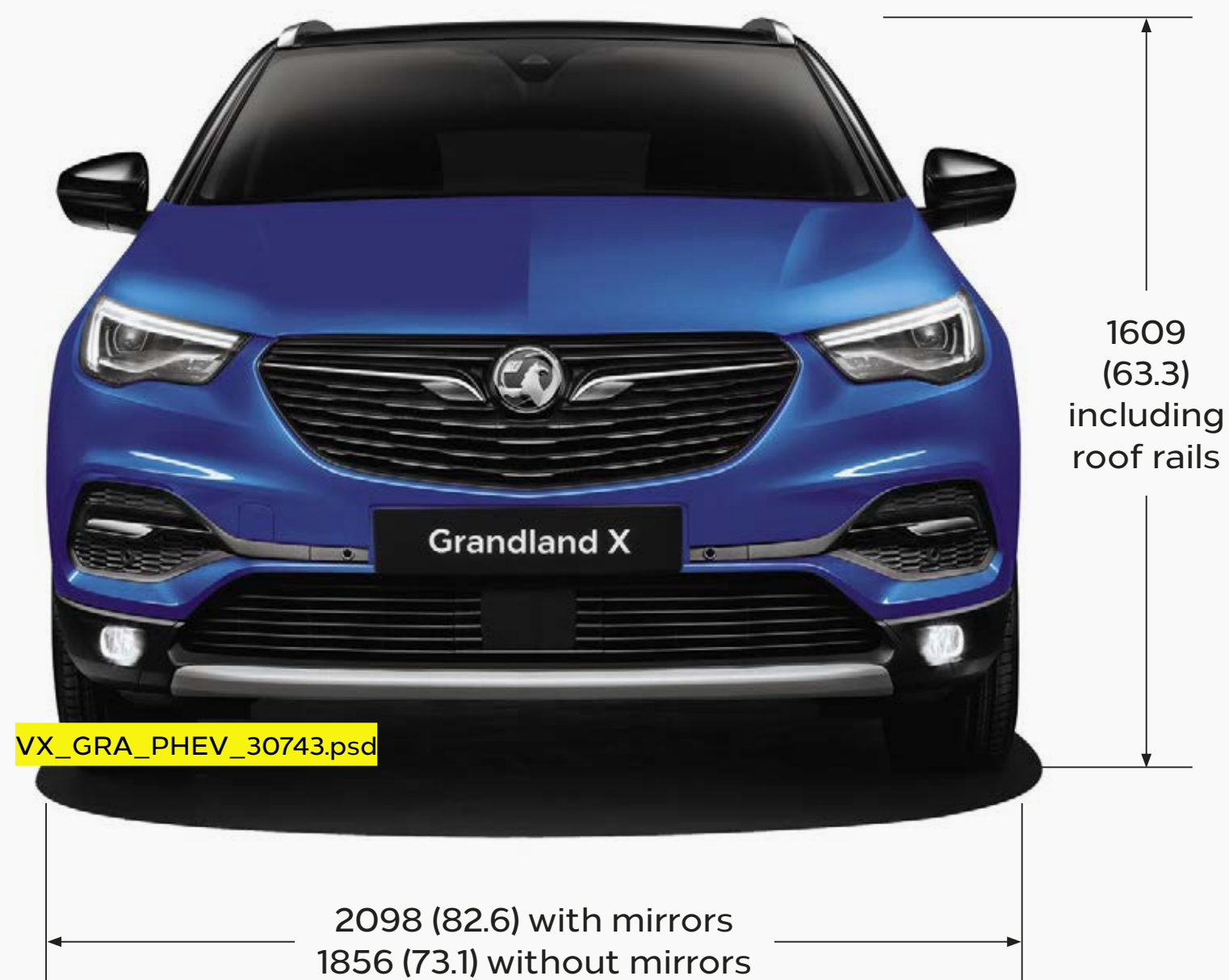

LOADSPACE DIMENSIONS mm (in)	Petrol/Diesel	Hybrid range
Maximum length (behind rear seats)	873 (34.4)	873 (34.4)
Maximum length (rear seats folded)	1696 (66.8)	1696 (66.8)
Maximum width	1053 (41.5)	1053 (41.5)
Maximum height	866 (34.1)	866 (34.1)

LUGGAGE CAPACITIES* Litres (cu.ft.)	Petrol/Diesel	Hybrid range
Rear seats up (under luggage compartment cover)	514 (18.1)	390 (13.7)
Rear seats folded (to roof)	1652 (58.3)	1528 (53.9)

*Measured using the ECIE method.

ACCESSORIES

CHILD SEATS ¹	Total (inc. VAT)
BABY-SAFE ² – 0-13kg/birth to 15 months	£152
– ISOFIX base	£263
DUO ISOFIX ² – 9-18kg/9 months to 4 years	
with top tether kit	£402
KID ² – 15-36kg or 4 to 12 years	£182

SAFETY	
Parking sensors	
– four fully flush rear bumper mounted sensors	£384
– four fully flush front bumper mounted sensors ³	£377
Rear view camera	£341
Alarm system	£426
Safety Pack – first aid kit, hi-visibility vest and small warning triangle	£30
Warning triangle – Small	£12
Warning triangle – Large	£20
First aid kit	£15
Hi-visibility vest	£9
Fire extinguisher – 2kg	£39

FLEXCONNECT RANGE	
FlexConnect bracket	£22
FlexConnect hook	£32
FlexConnect coat hanger	£34
FlexConnect folding table	£77
FlexConnect iPad Mini cradle	£109
FlexConnect iPad (1-4) cradle	£118
FlexConnect iPad Air cradle	£117
FlexConnect Samsung Galaxy cradle	£107

PRACTICAL	Total (inc. VAT)
Spare bulb kit ³	£28
Stretch tow rope – 3 tonne	£36
Smoker pack	£46
Privacy shades	
– Rear and rear side windows	£138
Side steps	£503

PROTECTION	
Rubber floor mats – set of four	£49
Velour floor mats – set of four	£59
Economy floor mats – set of four	£33
Cargo liner ⁴	£71
Dog guard (fitted)	£202
Splash Guards – front and rear	£105
Load compartment mat	£115

TRANSPORT SYSTEMS	Total (inc. VAT)
For roof rails	£197
Without roof rails	£203
Roof carriers (requires base carrier)	
Bike roof carrier – Thule Freeride 532	£78
Surf board roof carrier – Thule 833	£82
Kayak roof carrier – Thule 837	£172
Ski roof carrier (up to 4 pairs)	
– Thule 7324	£161
Ski roof carrier (up to 6 pairs)	
– Thule 7326	£190
Hard shell roof boxes (requires base carrier)	
Thule Ocean 80 (320 litre/1330 x 860 x 370mm)	£154
Thule Ocean 200 (450 litre/1750 x 820 x 450mm)	£323
Thule Motion 800 (460 litre/2050 x 840 x 450mm)	from £463
Thule Touring 200 (400 litre/1750 x 820 x 450mm)	£338
Thule Touring 700 (430 litre/2320 x 700 x 420mm)	£384
Tow bar carrier system	
Fixed tow bar ⁵	from £436
Detachable tow bar ⁵	from £572

STYLING	Total (inc. VAT)
Stainless steel pedal covers	
– manual	£65
– automatic	£57
Stainless Steel Door Sills	£43

Please note: Prices shown are fully fitted and painted, where applicable and include VAT. Please check with your local Vauxhall Retailer for details. It is advisable to ensure your insurance policy is adequate to cover additional fitted accessories. Prices correct at time of publication.

¹Restrictions apply to the use of child seats, please consult your Vauxhall Retailer or request a copy of the Child seats brochure. ²Without transponder. ³Excludes xenon headlight bulb for models with Adaptive Forward Lighting (AFL). ⁴Not available with Flex Floor option.

⁵Available with 7 pin, 13 pin and 12S electrics. Please consult your Vauxhall Retailer for details.

COMPANY CAR DRIVER AND FLEET INFORMATION

Benefit in kind company car taxation*

The car benefit charge will be the car's list price (including VAT, options and accessories fitted, delivery to Retailer and number plates, but excluding Vehicle Excise Duty and new vehicle first registration fee) multiplied by the percentage charge for the CO₂ emissions band in which the car falls (see table opposite). Multiply this figure by your personal income tax rate (20%** for Basic Rate, 40%** for Higher Rate) to calculate your annual benefit in kind tax liability.

Example:

Grandland X Business Edition Nav 1.5 (130PS) Turbo D (CO₂ emissions 137g/km)	
On-the-road RRP	£26,160.00
Deduct: Vehicle Excise Duty	(£215.00)
New vehicle first registration fee	(£55.00)
Effective list price	£25,890.00
Add: Optional two-coat metallic paint	£600.00
List price for tax purposes (P11D value)	£26,490.00
Car benefit charge 2020-21 tax year (30%)	£7,947.00
Benefit in kind tax liability (2020-21 tax year)	
Basic Rate (20%) tax payer	£1,589.40
Higher Rate (40%) tax payer	£3,178.80

*Lease note this Price Guide provides taxation information as a guide only. Vauxhall does not provide taxation guidance. Drivers should always take professional advice on their own tax position.

**Excludes residents of Scotland.

BIK FOR SCOTTISH RESIDENTS

Effective 6 April 2018 the Scottish Government have introduced their own BiK taxation structure. This only applies to Company Car Drivers that are Scottish taxpayers. HMRC will determine whether or not an individual is a Scottish taxpayer based on where their main place of residence is.

The BiK rates for Scotland are:

- Over £12,500-£14,549 Starter Rate 19%
- Over £14,549-£24,994 Basic Rate 20%
- Over £24,994-£43,430 Intermediate Rate 21%
- Over £43,430-£150,000 Higher Rate 41%
- Above £150,000 Top Rate 46%

CO ₂ emissions in grams per kilometre	Percentage of cars price to be taxed	
	Non-Diesel† 2020-21 tax year	Diesel†† 2020-21 tax year
Up to 50	12%	-
51-54	13%	-
55-59	14%	-
60-64	15%	-
65-69	16%	-
70-74	17%	-
75-79	18%	22%
80-84	19%	23%
85-89	20%	24%
90-94	21%	25%
95-99	22%	26%
100-104	23%	27%
105-109	24%	28%
110-114	25%	29%
115-119	26%	30%
120-124	27%	31%
125-129	28%	32%
130-134	29%	33%
135-139	30%	34%
140-144	31%	35%
145-149	32%	36%
150-154	33%	37%
155-159	34%	37%
160-164	35%	37%
165-169	36%	37%
170+	37%	37%

CO ₂ emissions in grams per kilometre	Electric range (miles)	Petrol, Electric, RDE2 Diesel††
0	-	0%
1-50	130+	0%
1-50	70-129	3%
1-50	40-69	6%
1-50	30-39	10%
1-50	<30	12%

†Also applies to diesel vehicles that meet the Real Driving Emissions Step 2 (RDE2). ††Applies to vehicles that do not meet the Real Driving Emissions Step 2 (RDE2).

To calculate your own personal liability, search: **Vauxhall BiK**, or click the link below: [Vauxhall BiK Tool](#)

Company Car Driver Free 3 Day Test Drive

Our free[‡] 3 Day Test Drive programme is open to all Company Car Drivers which allows you to choose any model in the current Vauxhall line-up (exclusions apply). With full insurance cover provided, it gives you a meaningful length of time to make an informed decision about your next company car.

Search Vauxhall 3DTD to book your FREE[‡] test drive or click the link the below:

[Vauxhall 3 Day Test Drive](#)

[‡]The free 3 Day Test Drive programme is open to Company Car Drivers and Fleet Decision Makers. Available for UK Mainland only. Terms and conditions apply. Full terms and conditions can be found at vauxhallfleet.co.uk/testdrive/index/terms.

Fleet Toolbox

Discover the facts in our online Toolbox for both Company Car Drivers and Fleet Decision Makers. The Fleet Toolbox has a host of useful calculators, comparators, interactive listings and information. Search Vauxhall Fleet Tools or click the link below:

[Vauxhall Fleet Tool Box](#)

Contact Vauxhall Fleet

Please contact one of our dedicated sales teams who will be happy to help with your particular enquiry.

Company Car Drivers

Call: 0345 111 2020

Email: company-car@vauxhallinfo.co.uk

Telephone lines are open

- Monday to Friday 8:00am-9:00pm

- Saturday and Sunday 9:00am-6:00pm

Fleet Decision Makers

Depending on the size of your fleet of vehicles, we have a dedicated team to handle your enquiries. The lines are open Monday to Friday excluding Bank Holidays.

1-24 vehicles

Call: 0845 076 2254 (8:30am-5:00pm)

25+ vehicles

Call: 0330 587 8222 (8:30am-5:00pm)

Email: vauxhallfleet@vauxhall.co.uk

Special Vehicles (Police, Fire and Ambulance)

Call: 01582 409999 (8:30am-5:00pm)

Email: vauxhallspecialvehicles@vauxhall.co.uk

For more information visit www.vauxhall.co.uk/fleet

FURTHER INFORMATION

On-the-road prices

To eliminate uncertainty about hidden costs when buying a new car, Vauxhall publishes on-the-road recommended retail prices (RRP) and these are shown in the pricing tables within this price guide. These prices include VAT, number plates and delivery to Retailer of £700.00 (including £116.67 VAT), 12 months' Government Vehicle Excise Duty (see opposite for details) and the DVLA new vehicle first registration fee of £55.00.*

Please note: The on-the-road recommended retail price (RRP) does not include fuel supplied by the Retailer, motor insurance or any other goods or services supplied by agreement between the Retailer and the customer.

Price protection

Order a new Vauxhall for build in the current model year (as confirmed by your Retailer) for delivery no more than three months in advance and the price you are quoted is the price you pay. This is irrespective of any subsequent price rises between placing your order and delivery of your new car, but you must take delivery as soon as the car is available.

Please note: Price protection does not apply to Corsa-e/Grandland X hybrid models. Vauxhall Motors Limited is not liable for price adjustments caused by Government changes in the rate of VAT (currently 20%), Vehicle Excise Duty, DVLA new vehicle first registration fee or by any other applicable legislation or regulations.

In the event of an accident

Vauxhall Accident Management helps keep you mobile following an accident. Benefits include vehicle recovery, Vauxhall-approved repairs and contacting your insurer. For more details, visit www.vauxhall.co.uk/AccidentManagement

Free2Move Lease

Whether you're a big company or a small business looking for vehicle financing, Free2Move Lease, our business finance specialists, can deliver exactly what you need.

Free2Move Lease is one of the UK's largest leasing companies and is also a member of the British Vehicle Rental and Leasing Association (BVRLA).

With over 60,000 vehicles in the Free2Move Lease portfolio, Free2Move Lease is able to offer competitive vehicle solutions. In addition, Free2Move Lease also offer innovative connected management of servicing and maintenance.

For further information, please contact your local Vauxhall Retailer or visit www.vauxhall.co.uk/offers-finance/business-leasing.html

Vehicle Excise Duty

The amount of Vehicle Excise Duty (road fund licence) payable on new cars varies depending on the level of carbon dioxide (CO₂) emissions produced by the vehicle. CO₂ emissions are measured in grams per kilometre (g/km) travelled and divided into 13 charging bands shown in the table opposite.

A 'first year rate' of Vehicle Excise Duty is payable on all new cars and in subsequent years the amount payable reverts to the 'standard rate'. From 1 April 2017 the breakpoints for each of these bands have been revised. Also, for vehicles with a list price over £40,000, including factory-fitted options, an additional £320 is payable for the first five years of standard rate payments.

Vehicle Excise Duty*

Band	CO ₂ emissions in grams per kilometre	First year rate		Standard rate	First year rate	
		Petrol [#]	Diesel [†]		Hybrid	Standard rate
A	0	£0	£0	£0	£0	£0
B	1-50	£10	£25	£145	£0	£135
C	51-75	£25	£110	£145	£15	£135
D	76-90	£110	£135	£145	£100	£135
E	91-100	£135	£155	£145	£125	£135
F	101-110	£155	£175	£145	£145	£135
G	111-130	£175	£215	£145	£165	£135
H	131-150	£215	£540	£145	£205	£135
I	151-170	£540	£870	£145	£530	£135
J	171-190	£870	£1,305	£145	£860	£135
K	191-225	£1,305	£1,850	£145	£1,295	£135
L	226-255	£1,850	£2,175	£145	£1,840	£135
M	Over 255	£2,175	£2,175	£145	£2,165	£135

*Correct at time of issue.

[#]Also applies to diesel vehicles that meet the Real Driving Emissions Step 2 (RDE2).

[†]Applies to vehicles that do not meet the Real Driving Emissions Step 2 (RDE2).

FURTHER INFORMATION

Customer Care Commitment

For added peace of mind, Vauxhall has an innovative Customer Care Commitment that offers the following:

- Three-year vehicle warranty consisting of a one-year/unlimited mileage manufacturer's warranty and a second and third year manufacturer's warranty with a 60,000 miles limitation
- Vauxhall Assistance for 12 months from first registration
- Six years' body panel anti-perforation warranty

Please note: Warranty is only available on vehicles sourced from Vauxhall Motors Limited. Terms and conditions apply – please see your Vauxhall Retailer for details.

Vauxhall Assistance

Vauxhall Assistance is provided automatically with every new Vauxhall for 12 months from first registration and covers everything from accident assistance, roadside recovery and 'at home' service to flat tyres. For even more peace of mind, on the Grandland X Hybrid range the cover is extended* to 8 years or 100,000 miles, whichever comes first. Even more reason for you to stay calm and let us take care of everything should the need arise. With Vauxhall Assistance help is literally just a free** phone call away, 24 hours a day, 365 days a year!

Protecting the environment

Vauxhall's commitment to the environment is demonstrated by our products' many environmental awards. For even more information on Vauxhall's efforts to achieve an environmentally sustainable future, and how to dispose of your end-of-life vehicle, see www.vauxhall.co.uk/recycling

Vauxhall Care

This all-inclusive service package is available on Vauxhalls under 10 months old (from date of first registration).

This package offers complete peace of mind for the first 3 years of your Vauxhall's life with fixed monthly payments for the plan duration.

- **3 years' Vauxhall servicing** – covers first, second and third annual services. Including a brake-fluid change in the second service
- **2 years' Vauxhall Roadside Assistance** – first year from us
- **First years' MOT[†]** – free of charge by your local Vauxhall Retailer

For full terms and conditions and to sign up, visit: vauxhall.co.uk/vauxhallcare

Vauxhall Service Club

Vauxhall Service Club is available for all Vauxhall owners, and it's free to join. Members benefit from the following:

- 15% off Vauxhall Approved Accessories
- Vauxhall's aged 2-3 Years = 15% off parts and labour
- Vauxhall's aged over 3 Years = 25% off parts and labour
- Half price MOT's (NI excluded)
- Free pre-MOT test inspection (NI only)
- Fixed price AdBlue Refills
 - Car = £14.99
 - Van = £24.99
- Access to the Vauxhall Accident Management Programme
- Online service booking available 24/7 with servicing appointments available within 3 days – [Book Online](#)
- Collection and delivery/onward mobility options
- Complimentary 'Wash and Vac' with all routine services^{††}
- Vauxhall trained technicians
- Genuine Vauxhall parts
- Minimum 12 months warranty on parts and labour
- Regular newsletters with exclusive offers, discounts and competitions

Terms and conditions apply. To join visit: vauxhall.co.uk/serviceclub

Vauxhall Insurance with added reassurance

Comprehensive cover – Summary of benefits

- Competitive premiums
- Repairs by a Vauxhall-trained technician
- Genuine Vauxhall parts, guaranteed for five years when we repair your car within our Approved Repairer Network
- Free courtesy car as standard when using an Approved Repairer[‡]
- 24 hour claims helpline
- Personal Accident benefit
- Cover for audio equipment
- Windscreen cover

Call for a quote on 0330 678 1130^{##}

For more product information

For further information on the Vauxhall range or location of your nearest Vauxhall Retailer please call **0345 600 1500**. Alternatively, details can be found on our website at vauxhall.co.uk

* Terms and conditions apply. Please click [here](#) for full terms and conditions

**Mobile phone users will be charged at their standard tariff.

[†]First years' MOT is not available for Northern Ireland.

^{††}Participating Retailers only.

[‡]Should your car need repairing following an accident we provide a courtesy car (subject to availability) for the duration of the repair. Only genuine Vauxhall parts are used. Terms and conditions apply.

^{##}Calls may be recorded. Vauxhall Insurance Services is a trading name of Europa Group Limited which is authorised and regulated by the Financial Conduct Authority. Europa Group Limited's Financial Services Register number 309794. Registered as a limited company in England and Wales No 03279177. Registered Office: Europa House, Midland Way, Thornbury, Bristol, BS35 2JX.

TRUST VAUXHALL

Company Car Driver Free 3 Day Test Drive:

Our free* 3 Day Test Drive programme is open to all Company Car Drivers. It allows you to choose most models in the current Vauxhall line-up (exclusions apply). With full insurance cover provided, it gives you a meaningful length of time to make an informed decision about your next company car. To book your free* test drive just log on to vauxhall3dtd.co.uk or call 0330 587 8221**.

Fleet Customer Services:

Our dedicated support services for fleet decision-makers include factory demonstrators and information on whole life costs, company car taxation and finance. For further information please call 0330 587 8222

For More Product Information:

For further information on the Vauxhall range or location of your nearest Vauxhall Retailer please call 0345 600 1500.

TAKE THE NEXT STEP



JOIN US ONLINE

Discover the full Vauxhall range at vauxhall.co.uk >

*The free 3 Day Test Drive programme is open to Company Car Drivers and Fleet Decision-Makers. Available for UK Mainland only. Terms and Conditions apply. Full terms and conditions can be found at vauxhallfleet.co.uk/testdrive/index/terms. **Telephone lines open Monday-Friday 9.00am to 5.00pm excluding Bank Holidays. Calls may be recorded or monitored for quality and/or training purposes.

Privacy Policy: For full details please visit vauxhall.co.uk/privacy

The invoice price, including delivery to Retailer, factory-fitted options, accessories fitted by the Retailer and number plates, is subject to VAT. Some feature descriptions in this guide may refer to, and some illustrations may show, optional equipment not included in the standard delivery. The information contained in this guide was accurate at the time of publication. We reserve the right to make changes in design and equipment. Please note that Vauxhall Retailers are not the agents of Vauxhall Motors Limited and are not authorised to bind Vauxhall Motors Limited by any specific or implied undertaking or representation. It is advisable to ensure that your motor insurance policy provides adequate cover for additional fitted options and accessories. The colours in this guide are only approximate actual colours. Illustrated optional equipment is available at extra charge. Availability, technical features and equipment provided on our vehicles can vary by model. For precise information on the equipment provided on our vehicles, please contact your local Vauxhall Retailer.

COMBO LIFE

Price and Specification Guide | 5 June 2020 | Model Year 2020



VAUXHALL

CONTENTS

To find the information you want use the links below to navigate around the guide:

[RANGE HIGHLIGHTS >](#)

Explore the Combo Life range and find your perfect model.

[MODELS >](#)

Find all the information you need about your chosen model.

[PRICES >](#)

Find on-the-road recommended retail prices.

[FEATURES/OPTIONS >](#)

Tailor your chosen model to suit your needs with everything from satellite navigation to rear-view camera and parking sensors.

[EXTERIOR COLOURS >](#)

Add some sparkle to your car with a metallic paint.

[WHEELS AND TYRES >](#)

Why not upgrade to a set of distinctive alloy wheels to give your car more presence.

[PERFORMANCE, FUEL ECONOMY AND EMISSIONS >](#)

Know how many miles you will get around town, the CO₂ figures and the 0-60 time.

[DIMENSIONS >](#)

Ensure your car will fit in the garage and know how much luggage you can take for a long weekend away.

[SPECIFICATIONS >](#)

Towing weights, engine details and other useful details you may need to know.

[ACCESSORIES >](#)

Add some practical touches to your car with our range of quality accessories.

[COMPANY CAR INFORMATION >](#)

Benefit in Kind company car tax, 3 day test drives and P11D.

[FURTHER INFORMATION >](#)

Price protection, vehicle excise duty, our range of additional products and much more.

COMBO LIFE RANGE HIGHLIGHTS



VX_COM_30075.psd

DESIGN OTR from £22,125

Standard features include:

Infotainment:

- AM/FM/DAB digital radio, Bluetooth®, USB audio connection with four speakers

Interior:

- Height-adjustable driver's seat
- 60/40 split-folding rear seat back
- Air conditioning
- Steering wheel mounted audio controls
- 3.5-inch colour display

Exterior:

- Electrically adjustable/heated door mirrors
- Electrically operated front windows
- Nearside and offside sliding side-access door with opening windows
- Daytime running lights
- Tailgate with heated rear window and wiper
- Body-colour front and rear bumpers
- Side protection mouldings
- Emergency tyre inflation kit

Safety/security:

- Automatic emergency braking with pedestrian detection
- Electronic stability programme with traction control
- Forward collision alert
- Lane keep assist with lane departure warning
- Automatic lighting control
- Keyless entry and start (on automatic models)
- Cruise control with speed limiter
- Speed sign recognition
- Six airbags • Driver drowsiness system



VX_COM_30486.psd

ENERGY OTR from £23,650

Features over Design:

Infotainment:

- Touchscreen infotainment system
- 8-inch colour touchscreen

Interior:

- Chrome-effect instrument rings
- Chrome-effect interior door handles
- Luggage compartment cover

Exterior:

- Body-colour exterior door mirrors and handles
- Front and rear parking sensors
- Front fog lights
- 16-inch alloy wheels with 205/60 R16 tyres
- Automatic windscreen wipers
- High beam assist
- Body-colour side-protection mouldings

7-SEAT OTR from £24,150

7-seat models additionally feature:

- Two individual split-folding and removable third-row seats
- Sliding facility for third-row seats (XL models only)
- Front-seat back pockets
- Two foldable tables with cupholders



VX_COM_30012.psd

ELITE OTR from £28,500

Features over Energy:

Infotainment:

- Multimedia Navi Pro satellite navigation system
- Wireless charger for mobile devices

Interior:

- Rear-view child-minder mirror
- Fold-flat front passenger seat
- Dual-zone electronic climate control
- Heated front seats
- Luggage restraint net

Exterior:

- 180° panoramic rear-view camera
- Electrically operated rear windows
- Electrically-foldable door mirrors
- Alloy-effect protective front skid plate
- Glazed tailgate with opening heated window and wash/wipe facility
- Dark-tinted rear windows • Roof rails
- 17-inch alloy wheels with 205/55 R17 tyres

Safety/security:

- Side blind spot alert
- Remote control security alarm system

7-SEAT OTR from £29,500

7-seat models additionally feature:

- 33/33/33 split-folding second-row seats with fold-flat facility
- Two individual split-folding and removable third-row seats

DESIGN



VX_COM_30075.psd



VX_COM_28471.tif



VX_COM_28470.tif



VX_COM_28611.tif

DESIGN ON-THE-ROAD PRICES

	5-seat MPV		Insurance
	OTR RRP	CO ₂ (g/km)	Group
Diesel			
1.5 (100PS) Turbo D S/S BlueInjection	£22,125	142	9E

Please note: On-the-road recommended retail prices (RRP) include VAT at 20%, number plates and delivery to Retailer of £700.00 (inc. £116.67 VAT), 12 months' Vehicle Excise Duty and new vehicle first registration fee of £55.00. Excludes fuel and insurance.

S/S = Start/Stop.

FEATURES

Infotainment:

- AM/FM/DAB digital radio, Bluetooth® audio streaming, Bluetooth® mobile phone portal, USB audio connection
- 3.5-inch colour display
- Four speakers

Interior convenience/styling:

- Height-adjustable driver's seat
- Air conditioning
- Steering wheel mounted audio controls
- 60/40 split-folding rear seat back

Exterior convenience/styling:

- Keyless entry and start – Standard on automatic models only
- Electrically adjustable/heated door mirrors
- Electrically operated front windows with safety autoreverse and one-touch up/down facility
- Nearside and offside sliding side-access door with opening windows
- Daytime running lights
- Tailgate with heated rear window and wiper
- Body-colour front and rear bumpers
- Moulded side-protection mouldings
- 16-inch steel wheels with 205/60 R16 tyres
- Full-diameter wheel covers
- Emergency tyre inflation kit

Safety/security:

- Automatic emergency braking with pedestrian detection
- Electronic stability programme with traction control
- Anti-lock braking system
- Forward collision alert
- Emergency brake assist
- Lane keep assist with lane departure warning
- Automatic lighting control
- Cruise control with speed limiter
- Speed sign recognition
- Six airbags
- Driver drowsiness system

ENERGY



VX_COM_30486.psd



VX_COM_28345.tif



VX_COM_28486.tif



VX_COM_28347.tif

ENERGY ON-THE-ROAD PRICES

	5-seat MPV		Insurance	7-seat MPV		Insurance
	OTR RRP	CO ₂ (g/km)	Group	OTR RRP	CO ₂ (g/km)	Group
Petrol						
1.2 (110PS) Turbo S/S	£23,650	156	8E	£24,150	159	8E
1.2 (130PS) Turbo S/S auto	£25,950	157	11E	£26,450	161	11E
Diesel						
1.5 (100PS) Turbo D S/S BlueInjection	£23,525	143	9E	£24,025	147	9E
1.5 (130PS) Turbo D S/S BlueInjection	£24,625	144	12E	-	-	-
1.5 (130PS) Turbo D S/S auto BlueInjection	£26,125	148	12E	-	-	-

ENERGY XL ON-THE-ROAD PRICES

	5-seat MPV		Insurance	7-seat MPV		Insurance
	OTR RRP	CO ₂ (g/km)	Group	OTR RRP	CO ₂ (g/km)	Group
Petrol						
1.2 (110PS) Turbo S/S	£24,550	157	8E	£25,150	161	8E
1.2 (130PS) Turbo S/S auto	-	-	-	£27,450	162	12E
Diesel						
1.5 (100PS) Turbo D S/S BlueInjection	£24,425	145	9E	£25,025	148	8E

Please note: On-the-road recommended retail prices (RRP) include VAT at 20%, number plates and delivery to Retailer of £700.00 (inc. £116.67 VAT), 12 months' Vehicle Excise Duty and new vehicle first registration fee of £55.00. Excludes fuel and insurance.

S/S = Start/Stop.

FEATURES

Infotainment:

- Touchscreen infotainment system digital radio, Bluetooth® audio streaming, Bluetooth® mobile phone portal, USB audio connection
- 8-inch colour touchscreen
- Apple CarPlay™/Android Auto™ • Six speakers

Interior convenience/styling:

- Height-adjustable driver's seat • Air conditioning
- Steering wheel mounted audio controls
- Chrome-effect instrument rings
- Chrome-effect interior door handles
- 60/40 split-folding rear seat back
- Two individual split-folding and removable third-row seats (7-seat models)
- Sliding facility for third row seats (7-seat XL models only)
- Front-seat back pockets (7-seat models)
- Two foldable tables with cupholders (7-seat models)
- Luggage compartment cover

Exterior convenience/styling:

- Keyless entry and start – Standard on automatic models only
- Automatic windscreen wipers • High beam assist
- Front and rear parking sensors • Front fog lights
- Electrically adjustable/heated body-colour door mirrors

- Electrically operated front windows with safety autoreverse and one-touch up/down facility
- Nearside and offside sliding side-access door with opening windows
- Daytime running lights
- Tailgate with heated rear window and wiper
- Body-colour bumpers, door handles and side-access door railcovers
- Body-colour side protection mouldings
- 16-inch alloy wheels with 205/60 R16 tyres
- Emergency tyre inflation kit

Safety/security:

- Automatic emergency braking with pedestrian detection
- Electronic stability programme with traction control
- Anti-lock braking system
- Forward collision alert
- Emergency brake assist
- Lane keep assist with lane departure warning
- Automatic lighting control
- Cruise control with speed limiter
- Speed sign recognition
- Six airbags • Driver drowsiness system

ELITE



VX_COM_30012.psd



VX_COM_28487.tif



VX_COM_28467.tif



VX_COM_29680.tif

ELITE ON-THE-ROAD PRICES

	5-seat MPV		Insurance	7-seat MPV		Insurance
	OTR RRP	CO ₂ (g/km)	Group	OTR RRP	CO ₂ (g/km)	Group
Petrol						
1.2 (130PS) Turbo S/S auto	£28,500	160	11E	£29,000	163	12E
Diesel						
1.5 (130PS) Turbo D S/S auto BlueInjection	£28,675	149	14E	£29,500	153	15E

ELITE XL ON-THE-ROAD PRICES

Diesel						
1.5 (130PS) Turbo D S/S auto BlueInjection	-	-	-	£30,500	153	14E

Please note: On-the-road recommended retail prices (RRP) include VAT at 20%, number plates and delivery to Retailer of £700.00 (inc. £116.67 VAT), 12 months' Vehicle Excise Duty and new vehicle first registration fee of £55.00. Excludes fuel and insurance.

S/S = Start/Stop.

FEATURES

Infotainment:

- Touchscreen infotainment system digital radio, Bluetooth® audio streaming, Bluetooth® mobile phone portal, USB audio connection
- 8-inch colour touchscreen
- Satellite navigation system
- Wireless charger for mobile devices
- Apple CarPlay™/Android Auto™ • Six speakers

Interior convenience/styling:

- Dual-zone electronic climate control
- Heated front seats
- Steering wheel mounted audio controls
- Rear-view child-minder mirror
- Fold-flat front passenger seat
- 60/40 split-folding rear seat back (5-seat models)
- 33/33/33 split-folding second-row seats with fold-flat facility (7-seat models)
- Two individual split-folding and removable third-row seats (7-seat models)
- Sliding facility for third row seats (7-seat XL models only)
- Front-seat back pockets (7-seat models)
- Two foldable tables with cupholders (7-seat models)
- Luggage compartment cover
- Luggage restraint net

Exterior convenience/styling:

- Keyless entry and start
- Automatic windscreen wipers • High beam assist
- Front and rear parking sensors
- Electrically operated front windows
- Electrically operated rear windows
- Glazed tailgate with opening heated window and wash/wipe facility
- Body-colour bumpers, door handles and side-access door railcovers
- Alloy-effect protective front skid plate
- Electrically-foldable door mirrors
- Advanced Park Assist
- Dark-tinted rear windows • Roof rails
- 17-inch alloy wheels with 205/55 R17 tyres
- Emergency tyre inflation kit

Safety/security:

- Automatic emergency braking with pedestrian detection
- Forward collision alert
- Lane keep assist with lane departure warning
- Automatic lighting control • Side blind spot alert
- Front fog lights
- Remote control security alarm system
- Cruise control with speed limiter
- Speed sign recognition
- Six airbags • Driver drowsiness system

COMBO LIFE PRICES

	Pack Code	Fuel Type	Price (£)	VAT (£)	Total (£)	On-the-road RRP (£)	Financial Year 2020/21 BiK 20% (£)	WLTP Combined CO ₂ (g/km)# - pack code	Insurance Groups
DESIGN									
1.5 (100PS) Turbo D	DF26 HE5M	Diesel	17,629.17	3,525.83	21,155	22,125	112.92	142	9E
ENERGY									
1.2 (110PS) Turbo	DL26 EQ6O	Petrol	18,629.17	3,725.83	22,355	23,650	130.63	156	8E
1.2 (130PS) Turbo auto	DL26 EF8O	Petrol	20,545.83	4,109.17	24,655	25,950	143.67	157	11E
1.5 (100PS) Turbo D	DL26 HE5O	Diesel	18,795.83	3,759.17	22,555	23,525	120.15	143	9E
1.5 (130PS) Turbo D	DL26 HG6O	Diesel	19,712.50	3,942.50	23,655	24,625	125.83	144	12E
1.5 (130PS) Turbo D auto	DL26 HD8O	Diesel	20,962.50	4,192.50	25,155	26,125	137.88	148	12E
ENERGY (7-seat)									
1.2 (110PS) Turbo	DL26 EQ6Q	Petrol	19,045.83	3,809.17	22,855	24,150	133.47	159	159
1.2 (130PS) Turbo auto	DL26 EF8Q	Petrol	20,962.50	4,192.50	25,155	26,450	150.82	161	161
1.5 (100PS) Turbo D	DL26 HE5Q	Diesel	19,212.50	3,842.50	23,055	24,025	126.68	147	147
ENERGY XL									
1.2 (110PS) Turbo	DL26 EQ6R	Petrol	19,379.17	3,875.83	23,255	24,550	135.73	157	8E
1.5 (100PS) Turbo D	DL26 HE5R	Diesel	19,545.83	3,909.17	23,455	24,425	128.82	145	12E
ENERGY XL (7-seat)									
1.2 (110PS) Turbo	DL26 EQ6X	Petrol	19,879.17	3,975.83	23,855	25,150	143.23	161	8E
1.2 (130PS) Turbo auto	DL26 EF8X	Petrol	21,795.83	4,359.17	26,155	27,450	156.65	162	12E
1.5 (100PS) Turbo D	DL26 HE5X	Diesel	20,045.83	4,009.17	24,055	25,025	132.02	148	8E
ELITE									
1.2 (130PS) Turbo auto	DN26 EF8E	Petrol	22,670.83	4,534.17	27,205	28,500	162.77	160	11E
1.5 (130PS) Turbo D auto	DN26 HD8E	Diesel	23,087.50	4,617.50	27,705	28,675	151.48	149	14E
ELITE (7-seat)									
1.2 (130PS) Turbo auto	DN26 EF8F	Petrol	23,087.50	4,617.50	27,705	29,000	165.68	163	12E
1.5 (130PS) Turbo D auto	DN26 HD8F	Diesel	23,504.17	4,700.83	28,205	29,500	158.97	153	15E
ELITE XL (7-seat)									
1.5 (130PS) Turbo D auto	DN26 HD8G	Diesel	24,337.50	4,867.50	29,205	30,500	164.47	153	14E

Combo Life's petrol and diesel engines meet the Real Driving Emissions Step 2 (RDE2) standards.

WLTP Combined CO₂ (g/km) figures, valid 3 March 2020, are based on a configured vehicle as per pack code for UK with no options fitted.

#Fuel consumption and CO₂ figures are determined according to the WLTP test cycle. CO₂ figures, BiK values and RRP pricing shown above are for a standard vehicle without any additional optional equipment. CO₂ figures are used to calculate Vehicle Excise Duty (VED) for the first registration of the vehicle and BiK. The addition of optional extras could increase the certified CO₂ emission output. This in turn may affect the amount of VED payable upon registration, and, for company car drivers, the P11D value and the amount of Benefit in Kind (BiK) tax payable. Figures shown are for comparison purposes and should only be compared to the fuel consumption and CO₂ values of other cars tested to the same technical standard. The fuel consumption achieved, and CO₂ produced, in real world conditions will depend upon a number of factors including, but not limited to: the accessories fitted (pre and post registration); variations in weather; driving styles and vehicle load. The WLTP (Worldwide Harmonised Light Vehicles Test Procedure) is used to measure fuel consumption and CO₂ figures. Full data relating to WLTP test cycles can be found at: www.vauxhall.co.uk/wltp

Please note: On-the-road recommended retail prices (RRP) include number plates and delivery to Retailer of £700.00 (inc. £116.67 VAT), 12 months' Vehicle Excise Duty and new vehicle first registration fee of £55.00. Excludes fuel and insurance. Company Car Benefit in Kind (BiK) rates are monthly based on the standard paint price.

FEATURES/OPTIONS

SAFETY

	Option code	Design	Energy	Elite	Price (£) exc. VAT	Price (£) inc. VAT
Driver/passenger airbags • Driver's airbag • Front passenger's airbag • Two front seat side-impact airbags • Full-size curtain airbags for driver and front and outer rear seat passengers		●	●	●		
Seatbelts • Lap and diagonal inertia-reel seatbelts (height-adjustable front) • Front body-lock diagonal seatbelt pretensioner system – Tightens the seatbelt during the early stages of a frontal impact. • Drivers and front passenger's lap belt pretensioner system • Front seatbelt force limiters – Reduces potential upper body injuries during a frontal impact • Anti-submarining ramps in front seats – Help prevent occupants sliding underneath the lap belt during a collision. • 'Seatbelt unfastened' audible warning and warning light.		●	●	●		
Child safety • Deactivation switch for front passenger's front and side-impact airbags – Permits the safe use of a child seat in the front passenger seat. • ISOFIX child seat mountings incorporating top tether anchor points located on second-row rear seats (does not include child seat) – Allows ISOFIX child safety seats to be securely fixed into the car. The ISOFIX mounting system reduces forward movement in an accident and makes the child seat easier to install. • Child-proof locks on rear doors		●	●	●		
Driver/passenger safety • Energy-absorbing steering column • Side-impact protection beams • Reinforced passenger safety cell • Deformation zones front and rear		●	●	●		
Braking and stability • Electronic stability programme • Anti-lock braking system • Corner stability control • Traction control • Hill start assist • Engine drag torque control – Improves directional stability by preventing the driven wheels from locking on slippery surfaces under the influence of engine braking. • Emergency brake assist • Electronic brakeforce distribution		●	●	●		
Tyre pressure • Deflation detection system		●	●	●		

● = Standard equipment.

FEATURES/OPTIONS

DRIVER ASSISTANCE

	Option code	Design	Energy	Elite	Price (£) exc. VAT	Price (£) inc. VAT
<p>Cruise control with speed limiter and intelligent speed adaptation</p> <p>The cruise control feature enables you to maintain a constant speed – making it ideal for economical motorway driving. The speed limiter function can be set to ensure that you do not exceed the speed limit and can be easily overridden if required. Working in conjunction with speed sign recognition, when a new speed limit is detected a message appears in the driver information display. You can then set the cruise control to the new speed limit with a simple press on a steering wheel button.</p>		●	●	●		
<p>Front camera system</p> <p>A range of class-leading driver assistance and safety features are controlled by the front camera system.</p>						
<p>Lane keep assist with lane departure warning</p> <p>If the driver has not actively steered or signalled, the lane departure warning system provides gentle steering correction and warns when the car moves outside of lane markings at speeds above 40mph.</p> <ul style="list-style-type: none"> • Warning light in instrument cluster • Audible warning • Facia on/off switch 		●	●	●		
<p>Speed sign recognition</p> <p>Detects and then displays speed limits, reducing uncertainty and the risk of speeding.</p> <ul style="list-style-type: none"> • Recognises different speed signs, including temporary speed restrictions • Displays reminder in the instrument cluster 						
<p>Driver drowsiness system</p> <p>The system monitors driving time and driving behaviour to help prevent accidents caused by tiredness.</p>		●	●	●		
<p>Forward collision alert</p> <p>The system operates automatically from 3mph and gives an audible warning as well as a visual warning when approaching another vehicle too quickly.</p>		●	●	●		

● = Standard equipment.

FEATURES/OPTIONS

DRIVER ASSISTANCE CONTINUED

	Option code	Design	Energy	Elite	Price (£) exc. VAT	Price (£) inc. VAT
<p>Automatic emergency braking with pedestrian detection</p> <p>The system works automatically in conjunction with forward collision alert, at speeds between 3mph and 70mph, and detects both vehicles and pedestrians. If no avoiding action is taken by the driver, at speeds below 19mph the system automatically slows the vehicle to a full stop with emergency braking of 0.9g. At speeds from 19mph to 70mph it brakes automatically to reduce speed by a maximum of 30mph – To reduce speed even further the driver must brake him/herself. The operational speed range of the system depends on the detected obstacle (mobile target: from 3 to 53mph; fixed target: from 3 to 70mph; pedestrian: from 3 to 37mph). Vauxhall driver assistance systems are intended to support the driver within the system-imminent limitations. The driver remains responsible for the driving task.</p>		●	●	●		
<p>Parking sensors</p> <ul style="list-style-type: none"> • Front and rear parking distance sensors with audible warning 			●	●		
<ul style="list-style-type: none"> • Rear parking distance sensors with audible warning 	UD7	○	●	●	166.67	200.00
<p>Parking Pack</p> <p>Intelligent ultrasonic sensors form part of the solution for today's crowded roads and car parks – Delivering exceptional assistance both when parking and protecting you on the open road.</p> <p>– Only available in conjunction with optional navigation unit.</p> <ul style="list-style-type: none"> • Front and rear parking distance sensors • 180° panoramic rear-view camera • Side blind spot alert • Electrically foldable door mirrors • Electrically operated rear windows • Front fog lights 	OL5	○			750.00	900.00
<p>Parking Pack</p> <p>Intelligent ultrasonic sensors form part of the solution for today's crowded roads and car parks – Delivering exceptional assistance both when parking and protecting you on the open road.</p> <p>– Only available in conjunction with optional navigation unit.</p> <ul style="list-style-type: none"> • 180° panoramic rear-view camera • Side blind spot alert • Electrically foldable door mirrors • Electrically operated rear windows 	OL5		○	●	333.33	400.00
<p>Adaptive cruise control</p> <p>– Diesel manual models. Only available in conjunction with Winter Pack.</p>	K38		○		208.33	250.00

● = Standard equipment. ○ = Optional at extra cost.

FEATURES/OPTIONS

DRIVER ASSISTANCE CONTINUED

	Option code	Design	Energy	Elite	Price (£) exc. VAT	Price (£) inc. VAT
<p>Advanced park assist</p> <p>Advanced park assist not only detects suitable parking spaces but also expertly steers into them for you. All you have to do is to drive forward or reverse and brake. The system works with both parallel and bay parking.</p> <ul style="list-style-type: none"> • Automatic pull-out function • Ultrasonic side sensors identify suitable parking spaces at speeds up to 12mph • Fully automated steering • Detailed forward/reverse instructions are shown in the instrument cluster <p>– Only available when the optional Parking Pack is specified.</p>	UFQ		○	●	166.67	200.00
<p>Head-up display</p> <p>The head-up display projects key information onto the windscreen so that the driver's eyes remain on the road at all times. The display is adjustable for height and brightness.</p> <p>Displays:</p> <ul style="list-style-type: none"> • Navigation directions (where fitted) • Speedometer • Rev counter • Set speed of cruise control and speed limiter • Forward collision alert 	UV6		○	○	295.83	355.00
<p>All Weather Pack</p> <p>For those drivers who regularly take their vehicle off road, this pack helps the driver cope with whatever conditions they encounter. Please note: The All Weather Pack option affects CO₂ emissions which may result in a change in Vehicle Excise Duty.</p> <ul style="list-style-type: none"> • IntelliGrip: A choice of five selectable modes to suit the driving conditions: ESP on, ESP off, snow, mud or sand • Includes all-weather tyres 	PS4	○	○		341.67	410.00
<p>Sight and Light Pack</p> <ul style="list-style-type: none"> • High beam assist • Rain-sensitive windscreen wipers <p>– Standard on automatic models.</p>	CWX	○	●	●	125.00	150.00
<p>Automatic lighting control</p>		●	●	●		

● = Standard equipment. ○ = Optional at extra cost.

FEATURES/OPTIONS

SECURITY

	Option code	Design	Energy	Elite	Price (£) exc. VAT	Price (£) inc. VAT
Standard security features <ul style="list-style-type: none"> • Electronically protected audio equipment • Engine deadlock immobiliser • Visible Vehicle Identification Number (VIN) • Locking wheel nuts (Energy models only) 		●	●	●		
Remote control central locking <ul style="list-style-type: none"> • Operates on doors, tailgate and fuel filler flap • Deadlocking • Driver's internal central locking activation switch • Two folding keys, each with integral remote control function 		●	●	●		
Remote control security alarm system <ul style="list-style-type: none"> • Remote control (operates in conjunction with central locking) • Bonnet protection – Prevents access to the engine bay. • Visible security LED on fascia • Luggage protection – Monitors the luggage compartment preventing access. • Door protection – Monitors the position of all doors • Ultrasonic intrusion sensor • Power alarm sounder • Vehicle theft attempt and diagnostic indication – Shows in the display any attempt to enter or steal the vehicle during driver absence. 	PS6	○	○	●	166.67	200.00

DRIVER INFORMATION

Instrumentation <ul style="list-style-type: none"> • Speedometer • Rev counter • Fuel gauge with low fuel level warning light • Water temperature gauge with warning light • Shift-up indication light (manual models only) – Indicates when to change gear for optimum fuel economy. 		●	●	●		
Driver information display (centrally located in instrument cluster) <ul style="list-style-type: none"> • Displays trip computer data • Total mileage • Service-due indicator • Deflation detection system • 3.5-inch colour information display 		●	●	●		
Multi-function trip computer (displayed on driver information display) <ul style="list-style-type: none"> • Trip mileage • Vehicle range based on remaining fuel • Average speed • Average fuel economy • Instantaneous fuel economy 		●	●	●		
Central fascia display (format dependent on infotainment unit) <ul style="list-style-type: none"> • Audio information • Digital clock with automatic RDS time adjustment • Outside air temperature with ice warning function • Additional features dependent on infotainment unit (see infotainment for details) 		●	●	●		

● = Standard equipment. ○ = Optional at extra cost.

FEATURES/OPTIONS

SEATING AND COMFORT

	Option code	Design	Energy	Elite	Price (£) exc. VAT	Price (£) inc. VAT
Adjustable steering column Reach and rake-adjustable steering column		●	●	●		
Comfort front seats Driver's seat: <ul style="list-style-type: none"> • Height • Reach • Backrest • Manual lumbar adjustment • Armrest • Under seat storage • Four-way adjustable head restraint Front passenger's seat: <ul style="list-style-type: none"> • Reach • Backrest • Four-way adjustable head restraint 		●	●	●		
Rear seating Second-row: <ul style="list-style-type: none"> • Three-person layout 60/40 split-folding rear seat • Height-adjustable and removable head restraints • ISOFIX child seat mountings incorporating top tether anchor points located on rear seats (does not include child seat) – Allows ISOFIX child safety seats to be securely fixed into the car. The ISOFIX mounting system reduces forward movement in an accident and makes the child seat easier to install 		●	●			
<ul style="list-style-type: none"> • Three-person layout 33/33/33 individual split-folding second-row seats with sliding function (XL models only) plus fold-flat facility • Height-adjustable and removable head restraints • ISOFIX child seat mountings incorporating top tether anchor points located on rear seats (does not include child seat) 				●		
Rear seating Third-row (7-seat models): <ul style="list-style-type: none"> • Two individual removable/folding seats • Height-adjustable and removable head restraints 			●	●		
Seat trim: <ul style="list-style-type: none"> • Mistral Grey with Curitiba fabric seat trim inserts 		●				
<ul style="list-style-type: none"> • Mistral Grey with Angora Stripe fabric seat trim inserts 			●	●		

● = Standard equipment.

FEATURES/OPTIONS

HEATING AND VENTILATION

	Option code	Design	Energy	Elite	Price (£) exc. VAT	Price (£) inc. VAT
Air conditioning • Air recirculation facility • Cabin particulate filter – Removes dust, airborne particles and pollen. • Multi-speed fan • Illuminated controls		●	●			
Electronic climate control including air conditioning • Dual-zone control – Allowing different, temperature settings for driver and front passenger. • Advanced predictive logic control system using sun sensors • Partial air recirculation – Faster warm up/cool down. • Cabin particulate filter – Removes dust, airborne particles and pollen. • Automatic air direction and fan speed with manual override • LCD temperature display • Illuminated controls	CJ2	○	○	●	166.67	200.00
Winter Pack  • Heated leather-covered steering wheel • Heated front seats – Not available on automatic models.	XIBV	○	○		250.00	300.00

INTERIOR CONVENIENCE AND STORAGE

Mirrors • Dipping rear-view mirror • Driver's sunvisor incorporating vanity mirror with cover		●	●	●		
Front compartments • Two fascia-mounted drinks holders • Two drinks holders in centre console • Large open storage pocket behind infotainment screen • Small open storage compartment behind gear knob • Two large and two small open door pockets • Open storage compartment below glovebox • Full-width overhead storage shelf with ambient lighting		●	●	●		
Sunroof/storage • Full-length panoramic glass sunroof with overhead storage and ambient lighting • Storage compartments above rear seats with additional access from rear load area – Not available on XL models or 7-seat models.	C2K		○		700.00	840.00
Rear compartments • Two door pockets		●	●	●		
Luggage area • Luggage compartment cover			●	●		

● = Standard equipment. ○ = Optional at extra cost.

FEATURES/OPTIONS

INTERIOR CONVENIENCE AND STORAGE CONTINUED

	Option code	Design	Energy	Elite	Price (£) exc. VAT	Price (£) inc. VAT
Child Pack <ul style="list-style-type: none"> • Rear-view child-minder mirror – Located above the regular rear-view mirror and lets the driver as well as the front seat passenger keep an eye on the kids and the tailgate whilst maintaining full concentration on the road ahead. • Rear side window sunblind • Fold-flat passenger seat • Luggage restraint net – Only available on 7-seat models. 	WV6		○	●	250.00	300.00

MECHANICAL

Front-wheel drive		●	●	●		
Five-speed manual gearbox – 1.5 (100PS) diesel models.		▲	▲			
Six-speed manual gearbox – 1.2 Petrol/1.5 (130PS) diesel models.		▲	▲			
Eight-speed automatic transmission – Available on 1.2 (130PS)/1.5 (130PS) models.		▲	▲	▲		

INFOTAINMENT

Radio Onboard features: <ul style="list-style-type: none"> • AM/FM stereo radio • DAB Digital radio • RDS with Traffic Programme • 20 watts per channel output Media connections: <ul style="list-style-type: none"> • USB connection with iPod control • Bluetooth® A2DP audio streaming (Advanced Audio Distribution Profile) Mobile phone portal: <ul style="list-style-type: none"> • Bluetooth® connectivity • Handsfree calls via steering wheel controls • Vehicle microphone 		●				
---	--	---	--	--	--	--

● = Standard equipment. ○ = Optional at extra cost. ▲ = See price page for details.

FEATURES/OPTIONS

INFOTAINMENT CONTINUED

	Option code	Design	Energy	Elite	Price (£) exc. VAT	Price (£) inc. VAT
<p>Multimedia</p> <p>Onboard features:</p> <ul style="list-style-type: none"> • 8-inch colour touchscreen • AM/FM stereo radio with 25 Station presets • DAB Digital radio • RDS with Traffic Programme • 20 watts per channel output • Four speakers <p>Media connections:</p> <ul style="list-style-type: none"> • USB connection with iPod control • Bluetooth® A2DP audio streaming (Advanced Audio Distribution Profile) <p>Mobile phone portal:</p> <ul style="list-style-type: none"> • Bluetooth® connectivity • Handsfree calls via steering wheel controls • Vehicle microphone • Phone book access – Contacts/last calls/missed calls etc. are mirrored on the display and are easily navigated using the touchscreen (features dependent on mobile phone). <p>Smartphone interface:</p> <ul style="list-style-type: none"> • Apple CarPlay™ • Android Auto™ – Smartphone projection that allows operations via voice command, touchscreen and buttons to control apps and music playback. 	IO5	○	●		166.67	200.00
<p>Multimedia Navi Pro</p> <p>Onboard features:</p> <ul style="list-style-type: none"> • 8-inch colour touchscreen • AM/FM stereo radio with 25 Station presets • DAB Digital radio • RDS with Traffic Programme • 20 watts per channel output • Four speakers <p>Navigation features:</p> <ul style="list-style-type: none"> • Satellite navigation system • 3D street level mapping • European coverage • Structured or one-box destination entry • Points-of-interest search • Eco routing • Map updates via USB <p>Media connections:</p> <ul style="list-style-type: none"> • USB connection with iPod control • Bluetooth® A2DP audio streaming (Advanced Audio Distribution Profile) <p>Mobile phone portal:</p> <ul style="list-style-type: none"> • Bluetooth® connectivity • Handsfree calls via steering wheel controls • Vehicle microphone • Phone book access – Contacts/last calls/missed calls etc. are mirrored on the display and are easily navigated using the touchscreen (features dependent on mobile phone). <p>Smartphone interface:</p> <ul style="list-style-type: none"> • Apple CarPlay™ • Android Auto™ – Smartphone projection that allows operations via voice command, touchscreen and buttons to control apps and music playback. 	IO6	○		●	541.67	650.00
			○		375.00	450.00

● = Standard equipment. ○ = Optional at extra cost.

FEATURES/OPTIONS

INFOTAINMENT CONTINUED

	Option code	Design	Energy	Elite	Price (£) exc. VAT	Price (£) inc. VAT
Steering wheel mounted audio controls		●	●	●		
Power supply • 12-volt electrical accessory socket in centre console • 12-volt electrical accessory socket (passenger side) • USB charging point in glovebox • USB charging/infotainment points – Infotainment unit and rear of centre console.		●	●	●		
230-volt electrical accessory socket • 230-volt electrical accessory socket – In lieu of passenger side 12-volt electrical accessory socket.	KI5	○	○	○	41.67	50.00
Wireless charging • Wireless charger for mobile devices – Inductive wireless charging facility in lower fascia.	K4C	○	○	●	87.50	105.00

EXTERIOR STYLING AND CONVENIENCE

Body styling • Chrome-effect front grille bar • Body-colour door handles/mirrors • Body-colour bumpers, side-protection mouldings and sliding rail cover			●	●		
• Alloy-effect protective front skid plate				●		
• Chrome-effect front grille bar • Body-colour bumpers		●				
Windscreen/windows • Solar heat-absorbing windscreen • Two-speed windscreen wipers with variable intermittent wipe • Electrically operated front windows with safety autoreverse and one-touch facility • Tinted windows • Heated rear window • Intermittent rear window wash/wipe		●	●	●		
• Dark-tinted rear windows – Only available when Parking Pack and Tailgate with opening window options are specified.	AKO		○	●	91.67	110.00

● = Standard equipment. ○ = Optional at extra cost.







FEATURES/OPTIONS

EXTERIOR STYLING AND CONVENIENCE CONTINUED

	Option code	Design	Energy	Elite	Price (£) exc. VAT	Price (£) inc. VAT
Door mirrors • Twin electrically adjustable/heated door mirrors • Manually folding door mirrors – Electrically foldable door mirrors on Elite models.		●	●	●		
• Electrically foldable door mirrors		□	□	●		
Tailgate • Glazed tailgate with heated window and wash/wipe facility		●	●	●		
• Glazed tailgate with opening heated window and wash/wipe facility – Only available with Parking Pack and dark-tinted rear windows.	J20		○	●	254.17	305.00
Tow bar • Detachable tow bar • Trailer stability programme integrated into ESP system	VQ9	○	○	○	500.00	600.00
Roof rails	E2R	○	○	●	125.00	150.00

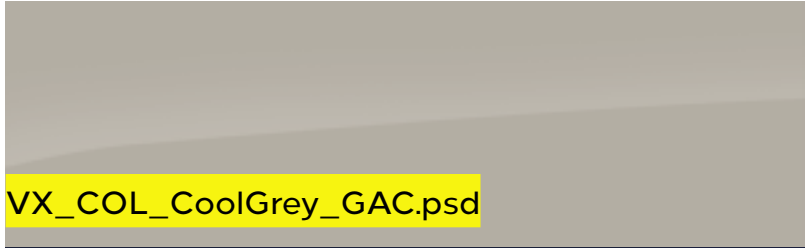
● = Standard equipment. ○ = Optional at extra cost. □ = Available as part of an extra-cost option pack.



EXTERIOR COLOURS

				Design	Energy	Elite	Price (£) exc. VAT	Price (£) inc. VAT	
Solid	 VX_COL_OnyxBlack_G7R.psd	Onyx Black (G7R)	 VX_COL_White_Jade_G20.psd	White Jade (G20)	●	●	●		
	 VX_COL_CoolGrey_GAC.psd	Cool Grey metallic (GAC)	 VX_COL_MoonstoneGrey_G40.psd	Moonstone Grey metallic (G40)	○	○	○	475.00	570.00
Two-coat	 VX_COL_NightBlue_GBT.psd	Night Blue metallic (GBT)	 VX_COL_QuartzGrey_G4i.psd	Quartz Grey metallic (G4I)					
	 VX_COL_CosmicBrown_GLV.psd	Cosmic Brown pearlescent (GLV)							

The colours reproduced may vary slightly from the actual paint colour. As a result they should be used as a guide only. Your Vauxhall Retailer has a comprehensive display of our paint samples.

● = Standard equipment. ○ = Optional at extra cost.

WHEELS AND TYRES

	Option code	Design	Energy	Elite	Price (£) exc. VAT	Price (£) inc. VAT
Full-size steel spare wheel (in lieu of emergency tyre inflation kit)	RU9	○	○	○	91.67	110.00
 <p>16-inch steel wheels with full diameter wheel covers</p> <ul style="list-style-type: none"> • 205/60 R 16 tyres • Emergency tyre inflation kit (in lieu of spare wheel) <p>VX_COM_28612_RRY.psd</p>		●				
 <p>16-inch seven-spoke alloy wheels</p> <ul style="list-style-type: none"> • 205/60 R 16 tyres • Emergency tyre inflation kit (in lieu of spare wheel) <p>VX_COM_28555_RRZ.psd</p>			●			
 <p>17-inch alloy wheels</p> <ul style="list-style-type: none"> • 205/55 R 17 tyres • Emergency tyre inflation kit (in lieu of spare wheel) <p>VX_COM_28556_RSB.psd</p>				●		

● = Standard equipment. ○ = Optional at extra cost.

PERFORMANCE, FUEL ECONOMY AND EMISSIONS

	Performance (manufacturer's figures)		Fuel economy mpg (litres/100km)#		CO ₂ emissions g/km#		Vehicle Excise Duty*		BiK rates from - 2020/21 tax year
	Maximum speed (mph)	Acceleration 0-60mph (sec)	Combined Low	Combined High	Combined Low	Combined High	First year rate	Standard rate	
COMBO LIFE									
1.2 (110PS) Turbo	109	11.9	37.5 (7.5)	40.9 (6.9)	156	170	£540	£145	34%
1.2 (130PS) Turbo automatic	tba	tba	40.3 (7.0)	40.3 (7.0)	157	170	£540	£145	34%
1.5 (100PS) Turbo D BlueInjection	107	12.7	42.2 (6.7)	52.3 (5.4)	142	176	£215	£145	31%
1.5 (130PS) Turbo D BlueInjection	115	10.6	44.8 (6.3)	51.3 (5.5)	144	164	£215	£145	31%
1.5 (130PS) Turbo D BlueInjection automatic	114	11.4	45.2 (6.2)	50.4 (5.6)	142	164	£215	£145	32%
COMBO LIFE XL									
1.2 (110PS) Turbo	109	12.0	37.5 (7.5)	40.9 (6.9)	157	170	£540	£145	34%
1.5 (100PS) Turbo D BlueInjection	107	12.9	42.2 (6.7)	51.3 (5.5)	148	164	£215	£145	32%
COMBO LIFE (7-SEAT)**									
1.2 (110PS) Turbo	109	11.8	37.5 (7.5)	40.3 (7.0)	159	170	£540	£145	34%
1.2 (130PS) Turbo automatic	tba	tba	40.3 (7.0)	39.2 (7.2)	161	170	£540	£145	35%
1.5 (100PS) Turbo D BlueInjection	106	12.7	42.2 (6.7)	50.4 (5.6)	147	176	£215	£145	32%
1.5 (130PS) Turbo D BlueInjection automatic	114	11.4	45.2 (6.2)	48.7 (5.8)	153	164	£540	£145	33%
COMBO LIFE XL (7-SEAT)**									
1.2 (110PS) Turbo	109	12.0	37.5 (7.5)	39.8 (7.1)	161	170	£540	£145	35%
1.2 (130PS) Turbo automatic	tba	tba	40.3 (7.0)	39.2 (7.2)	157	170	£540	£145	35%
1.5 (100PS) Turbo D BlueInjection	106	13.0	42.2 (6.7)	49.5 (5.7)	148	176	£215	£145	32%
1.5 (130PS) Turbo D BlueInjection automatic	114	11.4	45.2 (6.2)	48.7 (5.8)	153	164	£540	£145	33%

#Figures shown are for comparison purposes and should only be compared to the fuel consumption and CO₂ values of other cars tested to the same technical standard. The fuel consumption achieved, and CO₂ produced, in real world conditions will depend upon a number of factors including, but not limited to: the accessories fitted (pre and post registration); variations in weather; driving styles and vehicle load. The WLTP (Worldwide Harmonised Light Vehicles Test Procedure) is used to measure fuel consumption and CO₂ figures. The CO₂ figures display a range to reflect the highest value for the highest emitting version with all available options added, through to a minimum value to represent the lowest emitting version in standard specification.

*Correct at time of publication. **Available on Energy/Elite models only.

DIMENSIONS

Loadspace Dimensions	LIFE	LIFE XL
Maximum load floor length – passenger seat folded	2700 (106.3)	3050 (120.1)
Maximum load length – behind front seats	1880 (74.0)	2230 (87.8)
Maximum load length – behind second-row seats	914 (36.0)	1350 (53.1)
Maximum load length – behind third-row seats*	236 (9.3)	418 (16.5) – 566 (22.3)
Maximum load height	1126 (44.3)	1119 (44.0)
Maximum load width	1195 (47.0)	1195 (47.0)
Maximum width between wheel arches	1149 (45.2)	1129 (44.4)
Loading height	584 (23.0)	620 (24.4)
Maximum tailgate aperture width	1087 (42.8) – 1241 (48.9)	1087 (42.8) – 1241 (48.9)
Maximum tailgate aperture height	1126 (44.3)	1126 (44.3)
Maximum height under raised tailgate	1892 (74.5)	1892 (74.5)
Maximum side-access aperture width	640 (25.2) – 745 (29.3)	640 (25.2) – 745 (29.3)
Maximum side-access aperture height	1145 (45.1)	1145 (45.1)
Luggage Capacities** litres (cu.ft.)		
Behind front-row seats to glassline	1414 (49.9)	1672 (59.0)
Behind front-row seats to roof	2126 (75.1)	2693 (95.1)
Behind second-row seats to glassline	597 (21.1)	850 (30.0)
Behind second-row seats to roof	983 (34.7)	1538 (54.3)
Behind third-row seats*	571 (20.2)	806 (28.5)

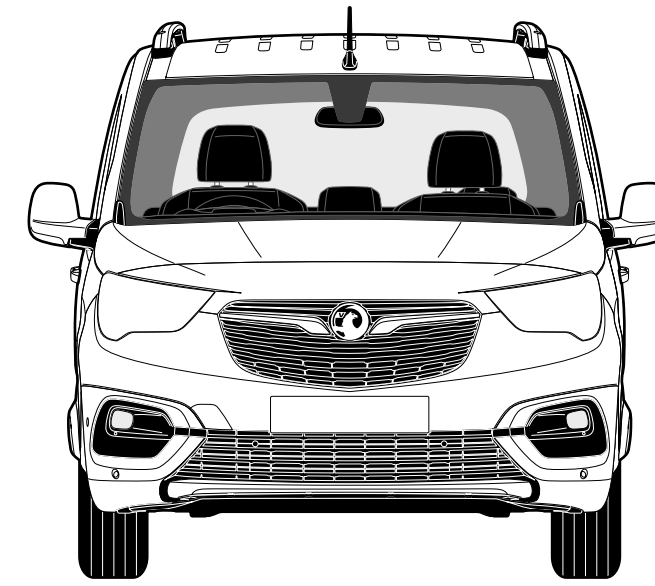

1921 (75.6)
excluding door mirrors
2107 (83.0)
including door mirrors

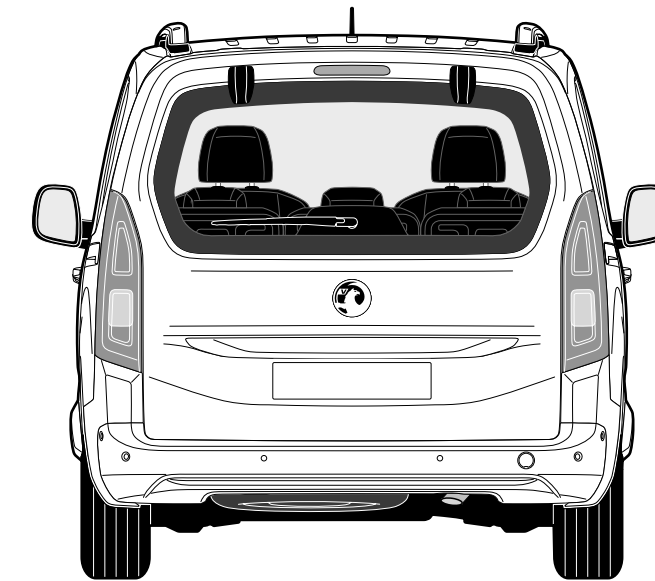

1921 (75.6)
excluding door mirrors
2107 (83.0)
including door mirrors

1841
(72.5)
including
roof rails

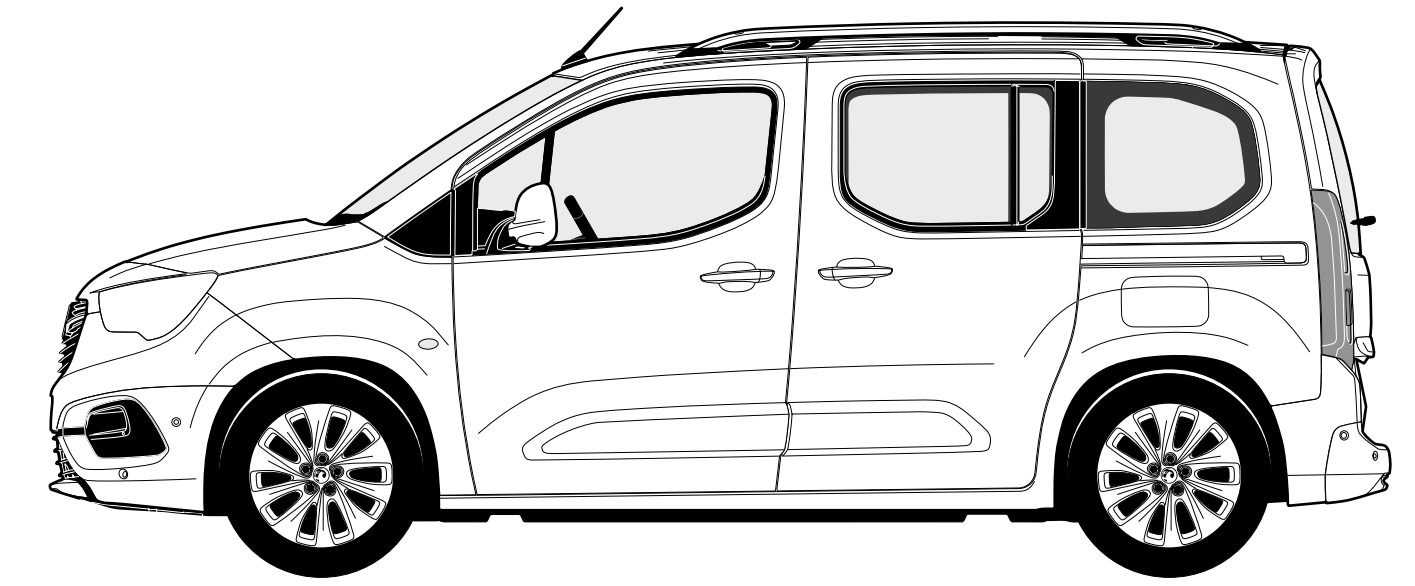

892 (35.1) 2785 (109.6) 726 (28.6)
4403 (173.3)

LIFE

1880
(74.0)
including
roof rails

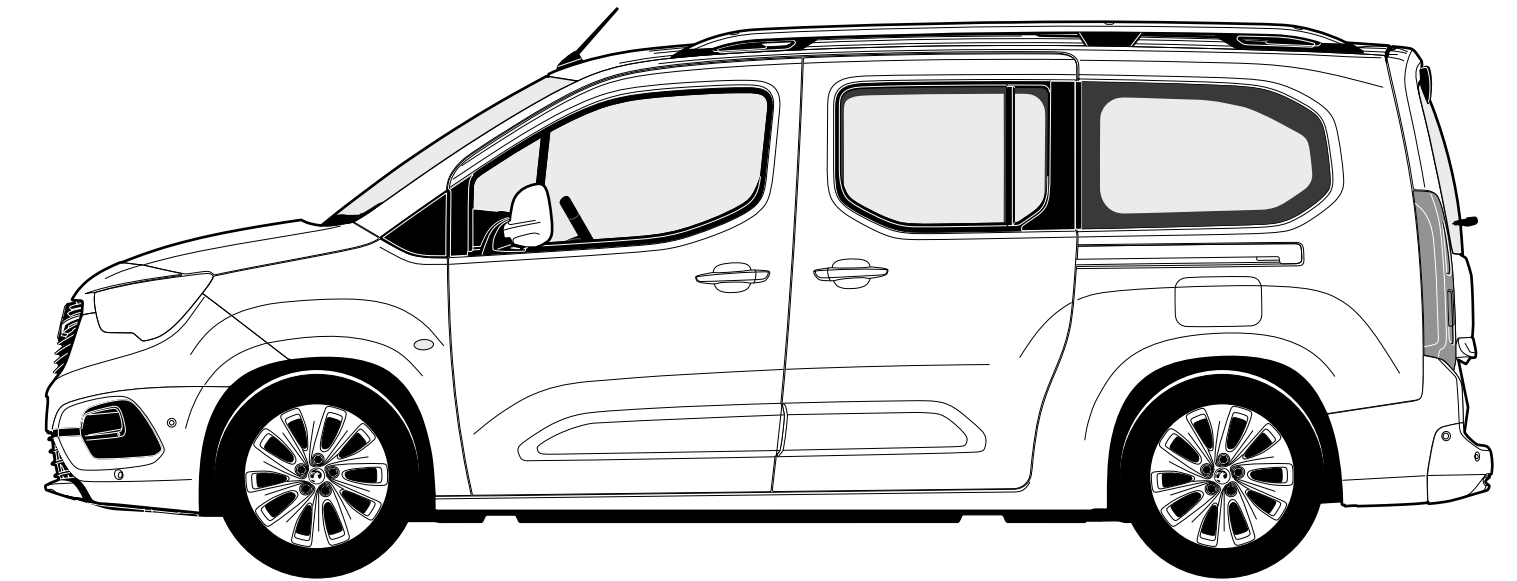

892 (35.1) 2977 (117.2) 884 (34.8)
4753 (187.1)

LIFE XL

All measurements are in mm (inches) unless stated otherwise.

*Energy/Elite models only.

**Measured using the ECIE method.

SPECIFICATIONS

Transmission

Five-speed manual gearbox:
1.5 (100PS) Turbo D models.

Six-speed manual gearbox:
1.2 (110PS) Turbo/1.5 (130PS) Turbo D models.

Eight-speed automatic transmission:
1.2 (130PS) Turbo/1.5 (130PS) Turbo D models.

Replacing the traditional lever, the automatic transmission selection-mode dial/drive wheel is an innovation solution that is both elegant and intuitive. By simply twisting the dial, the following modes can be selected:

- Park, for when the vehicle is stationary and the wheels are locked
- Drive, for automatic forward motion
- Neutral, for when the vehicle is stationary, wheels are free
- Reverse, for automatic backward motion

Fuel tank capacity

61 Litres (13.4 gallons) – Petrol models.
50 Litres (10.9 gallons) – Diesel models.

AdBlue tank capacity

17 Litres (3.7 gallons).

Steering

Turning circle (kerb-to-kerb) –
11.0m (36 ft) Life models,
11.8m (38.7 ft) Life XL models.

Weights and Towing Data kg

	Gross vehicle weight	Maximum towing weights Trailer with brakes (without brakes)
COMBO LIFE		
1.2 (110PS) Turbo	2050	1150 (720)
1.2 (130PS) Turbo automatic	2090	1200 (750)
1.5 (100PS) Turbo D	2095	1300 (750)
1.5 (130PS) Turbo D	2080	1420 (750)
1.5 (130PS) Turbo D automatic	2080	1320 (750)
1.2 (110PS) Turbo (7-seat)	2210	1000 (750)
1.5 (100PS) Turbo D (7-seat)	2255	1150 (750)
COMBO LIFE XL		
1.2 (110PS) Turbo	2070	1100 (750)
1.5 (100PS) Turbo D	2115	1250 (750)
1.2 (110PS) Turbo (7-seat)	2240	950 (750)
1.2 (130PS) Turbo automatic (7-seat)	2270	1000 (750)
1.5 (100PS) Turbo D (7-seat)	2285	1100 (750)
1.5 (130PS) Turbo D automatic (7-seat)	2320	1100 (750)

Gross vehicle weight is the total permissible weight of the vehicle including passengers and their luggage. The **maximum roof rack loading** should not exceed 100kg on all models. The **maximum towing weights** are based on the ability of the car, with two occupants of 75kg each, to restart on a 12% gradient, which is approximately 1 in 8.3, at sea level. The permitted trailer load applies up to the specified incline and up to an altitude of 1000 metres above sea level. The permissible gross train weight decreases by 10% for every 1000 metres of additional altitude. Any extra weight, such as luggage or additional passengers, should be deducted from the maximum towing weight. Always fit Vauxhall towing attachments and accessories available from your Vauxhall Retailer. They are designed specifically for Vauxhall models and carry a 12-month guarantee. During trailer towing do not exceed a maximum speed of 60mph. This speed limit is also applicable in countries with higher permitted speeds for trailer-vehicle combinations. Pay attention to the local speed limits. For trailers with low driving stability and caravans the use of an oscillation damper is strongly recommended.

PETROL ENGINES

Engine	1.2 (110PS) Turbo Start/Stop	1.2 (130PS) Turbo Start/Stop
Capacity	1199cc	1199cc
Maximum power	110PS (81kW) @ 5500rpm	130PS (96kW) @ 5500rpm
Maximum torque	205Nm (151 lb.ft.) @ 1750rpm	230Nm (170 lb.ft.) @ 1750rpm
Configuration	3 cylinders, 4 valves per cylinder, double overhead camshafts	3 cylinders, 4 valves per cylinder, double overhead camshafts
Fuel/induction system	Turbocharger. Variable Valve Timing. Direct fuel injection	Turbocharger. Variable Valve Timing. Direct fuel injection
Emission compliance	Euro 6d	Euro 6d
Service interval	16,000 miles or 1 year (whichever occurs sooner)	16,000 miles or 1 year (whichever occurs sooner)

DIESEL ENGINES

Engine	1.5 (100PS) Turbo D Start/Stop BlueInjection	1.5 (130PS) Turbo D Start/Stop BlueInjection
Capacity	1499cc	1499cc
Maximum power	100PS (75kW) @ 3500rpm	130PS (96kW) @ 3750rpm
Maximum torque	250Nm (184 lb.ft.) @ 1750rpm	300Nm (221 lb.ft.) @ 1750rpm
Configuration	4 cylinders, 4 valves per cylinder, double overhead camshafts	4 cylinders, 4 valves per cylinder, double overhead camshafts
Fuel/induction system	Variable-nozzle turbocharger with electric switching. Common rail direct injection	Variable-nozzle turbocharger with electric switching. Common rail direct injection
Emission compliance	Euro 6d Diesel Particulate Filter	Euro 6d Diesel Particulate Filter
Service interval	20,000 miles or 1 year (whichever occurs sooner)	20,000 miles or 1 year (whichever occurs sooner)

ACCESSORIES

SAFETY	Total (inc. VAT)
Safety Pack – first aid kit, hi-visibility vest and small warning triangle	£30
Warning triangle – Small	£12
Warning triangle – Large	£20
First aid kit	£15
Hi-visibility vest	£9
PRACTICAL	
Spare bulb kit	£28
Stretch tow rope – 3 tonne	£36
Smokers pack	£37
PROTECTION	
Carpet mats (set of 4)	£48
Carpet mats for 3rd row seat	£18
Rubber mats (set of 4)	£38
Splash Guards – Rear	£64
Front parking sensors	£437
Rear parking sensors	£384
Hard Cargo Liner	£57
Dog Guard	
Without sunroof	£252
With sunroof	£257

TRANSPORT SYSTEMS	Total (inc. VAT)
Roof base carrier ¹ (set of 2 bars)	£191
Additional roof base carrier (1 bar)	£96
Roof carriers (requires base carrier)	
Bike roof carrier – Thule Freeride 532	£78
Surf board roof carrier – Thule 833	£82
Kayak roof carrier – Thule 837	£172
Ski roof carrier (up to 4 pairs) Thule 7324	£161
Ski roof carrier (up to 6 pairs) Thule 7326	£190
Hard shell roof boxes (requires base carrier)	
Thule Ocean 80 (320 litre/1330 x 860 x 370mm)	£154
Thule Ocean 200 (450 litre/1750 x 820 x 450mm)	£323
Thule Motion 800 (460 litre/2050 x 840 x 450mm)	from £463
Thule Touring 200 (400 litre/1720 x 820 x 450mm)	£338
Thule Touring 700 (430 litre/1960 x 780 x 430mm)	£384

SECURITY	Total (inc. VAT)
Privacy Shades – Side Rear Windows (tilt/turn window) – set of 2	£46
Privacy Shades – Side Rear Windows (electric window) – set of 2	£46
Privacy Shades – Quarter Side Rear Window Set of 2	£46
Privacy Shade – Rear Window	£46
FLEXCONNECT RANGE	
FlexConnect bracket	£28
FlexConnect hook	£32
FlexConnect coat hanger	£34
FlexConnect folding table	£77
FlexConnect iPad Mini cradle	£109
FlexConnect iPad (1-4) cradle	£118
FlexConnect iPad Air cradle	£117
FlexConnect Samsung Galaxy cradle	£107
CHILD SEATS²	
BABY-SAFE ³ – 0-13kg/birth to 15 months	£152
– ISOFIX base	£263
DUO ISOFIX ³ – 9-18kg/9 months to 4 years with top tether kit	£402
KID ³ – 15-36kg or 4 to 12 years	£182

Please note: Prices shown are fully fitted and painted, where applicable and include VAT. Please check with your local Vauxhall Retailer for details. It is advisable to ensure your insurance policy is adequate to cover additional fitted accessories. Prices correct at time of publication.

¹A dedicated T-Track adapter (Thule 697-4 or Thule 697-6) is required for the installation of specific roof boxes, contact your local Vauxhall Retailer for details. ²Restrictions apply to the use of child seats, please consult your Vauxhall Retailer or request a copy of the Child seats brochure.

³Without transponder.

COMPANY CAR DRIVER AND FLEET INFORMATION

High spec, low P11D

As a business and company car driver, you'll find all of our models are seriously fit for fleet; we're talking very low P11D values, generous standard specification and high-tech engines designed for great fuel economy and low emissions – and that's just to get you started.

To get access to even more spec as standard, simply take a step up in the range – low P11D values will continue to apply.

Drivers and businesses all have unique requirements and by taking advantage of low whole-life costs and low company car driver taxation you can get in the driving seat with the spec to suit.

Company Car Driver Free 3 Day Test Drive

Our free* 3 Day Test Drive programme is open to all Company Car Drivers which allows you to choose any model in the current Vauxhall line-up (exclusions apply). With full insurance cover provided, it gives you a meaningful length of time to make an informed decision about your next company car.

Search Vauxhall 3DTD to book your FREE* test drive or click the link the below:

[Vauxhall 3 Day Test Drive](#)

*The free 3 Day Test Drive programme is open to Company Car Drivers and Fleet Decision Makers. Available for UK Mainland only. Terms and conditions apply. Full terms and conditions can be found at vauxhallfleet.co.uk/testdrive/index/terms.

Benefit in kind company car taxation**

The car benefit charge will be the car's list price (including VAT, options and accessories fitted, delivery to Retailer and number plates, but excluding Vehicle Excise Duty and new vehicle first registration fee) multiplied by the percentage charge for the CO₂ emissions band in which the car falls (see table opposite). Multiply this figure by your personal income tax rate (20%[†] for Basic Rate, 40%[†] for Higher Rate) to calculate your annual benefit in kind tax liability.

Example:

Combo Life Design 1.5 (100PS) Turbo D S/S BlueInjection (CO₂ emissions 142g/km)

On-the-road RRP	£21,125.00
Deduct: Vehicle Excise Duty	(£215.00)
New vehicle first registration fee	(£55.00)
Effective list price	£20,855.00
Add: Optional two-coat metallic paint	£570.00
List price for tax purposes (P11D value)	£21,425.00
Car benefit charge 2020–21 tax year (31%)	£6,642.00
Benefit in kind tax liability (2020–21 tax year)	
Basic Rate (20%) tax payer	£1,328.40
Higher Rate (40%) tax payer	£2,656.80

**Please note this Price Guide provides taxation information as a guide only. Vauxhall does not provide taxation guidance. Drivers should always take professional advice on their own tax position.

[†]Excludes residents of Scotland.

BIK FOR SCOTTISH RESIDENTS

Effective 6 April 2018 the Scottish Government have introduced their own BiK taxation structure. This only applies to Company Car Drivers that are Scottish taxpayers. HMRC will determine whether or not an individual is a Scottish taxpayer based on where their main place of residence is.

The BiK rates for Scotland are:

- Over £12,500–£14,549 Starter Rate 19%
- Over £14,549–£24,994 Basic Rate 20%
- Over £24,994–£43,430 Intermediate Rate 21%
- Over £43,430–£150,000 Higher Rate 41%
- Above £150,000 Top Rate 46%

CO ₂ emissions in grams per kilometre	Percentage of cars price to be taxed	
	Non-Diesel ^{††} 2020-21 tax year	Diesel [†] 2020-21 tax year
Up to 50	12%	–
51–54	13%	–
55–59	14%	–
60–64	15%	–
65–69	16%	–
70–74	17%	–
75–79	18%	22%
80–84	19%	23%
85–89	20%	24%
90–94	21%	25%
95–99	22%	26%
100–104	23%	27%
105–109	24%	28%
110–114	25%	29%
115–119	26%	30%
120–124	27%	31%
125–129	28%	32%
130–134	29%	33%
135–139	30%	34%
140–144	31%	35%
145–149	32%	36%
150–154	33%	37%
155–159	34%	37%
160–164	35%	37%
165–169	36%	37%
170+	37%	37%

Fleet Toolbox

Discover the facts in our online Toolbox for both Company Car Drivers and Fleet Decision Makers. The Fleet Toolbox has a host of useful calculators, comparators, interactive listings and information.

Search Vauxhall Fleet Tools or click the link below:

[Vauxhall Fleet Tool Box](#)

Contact Vauxhall Fleet

Please contact one of our dedicated sales teams who will be happy to help with your particular enquiry.

Company Car Drivers

Call: 0345 111 2020

Email: company-car@vauxhallinfo.co.uk

Telephone lines are open

– Monday to Friday 8:00am–9:00pm

– Saturday and Sunday 9:00am–6:00pm

Fleet Decision Makers

Depending on the size of your fleet of vehicles, we have a dedicated team to handle your enquiries. The lines are open Monday to Friday excluding Bank Holidays.

1–24 vehicles

Call: 0845 076 2254 (8:30am–5:00pm)

25+ vehicles

Call: 0330 587 8222 (8:30am–5:00pm)

Email: vauxhallfleet@vauxhall.co.uk

Special Vehicles (Police, Fire and Ambulance)

Call: 01582 409999 (8:30am–5:00pm)

Email: vauxhallspecialvehicles@vauxhall.co.uk

^{††}Also applies to diesel vehicles that meet the Real Driving Emissions Step 2 (RDE2). [†]Applies to vehicles that do not meet the Real Driving Emissions Step 2 (RDE2).

To calculate your own personal liability, search:

Vauxhall BiK, or click the link below:

[Vauxhall BiK Tool](#)

For more information visit www.vauxhall.co.uk/fleet

FURTHER INFORMATION

On-the-road prices

To eliminate uncertainty about hidden costs when buying a new car, Vauxhall publishes on-the-road recommended retail prices (RRP) and these are shown in the pricing tables within this price guide. These prices include VAT, number plates and delivery to Retailer of £700.00 (including £116.67 VAT), 12 months' Government Vehicle Excise Duty (see opposite for details) and the DVLA new vehicle first registration fee of £55.00.*

Please note: The on-the-road recommended retail price (RRP) does not include fuel supplied by the Retailer, motor insurance or any other goods or services supplied by agreement between the Retailer and the customer.

Price protection

Order a new Vauxhall for build in the current model year (as confirmed by your Retailer) for delivery no more than three months in advance and the price you are quoted is the price you pay. This is irrespective of any subsequent price rises between placing your order and delivery of your new car, but you must take delivery as soon as the car is available. Vauxhall Motors Limited is not liable for price adjustments caused by Government changes in the rate of VAT (currently 20%), Vehicle Excise Duty, DVLA new vehicle first registration fee or by any other applicable legislation or regulations.

In the event of an accident

Vauxhall Accident Management helps keep you mobile following an accident. Benefits include vehicle recovery, Vauxhall-approved repairs and contacting your insurer. For more details, visit www.vauxhall.co.uk/AccidentManagement

Free2Move Lease

Whether you're a big company or a small business looking for vehicle financing, Free2Move Lease, our business finance specialists, can deliver exactly what you need.

Free2Move Lease is one of the UK's largest leasing companies and is also a member of the British Vehicle Rental and Leasing Association (BVRLA).

With over 60,000 vehicles in the Free2Move Lease portfolio, Free2Move Lease is able to offer competitive vehicle solutions. In addition, Free2Move Lease also offer innovative connected management of servicing and maintenance.

For further information, please contact your local Vauxhall Retailer or visit www.vauxhall.co.uk/offers-finance/business-leasing.html

Vehicle Excise Duty

The amount of Vehicle Excise Duty (road fund licence) payable on new cars varies depending on the level of carbon dioxide (CO₂) emissions produced by the vehicle. CO₂ emissions are measured in grams per kilometre (g/km) travelled and divided into 13 charging bands shown in the table opposite.

A 'first year rate' of Vehicle Excise Duty is payable on all new cars and in subsequent years the amount payable reverts to the 'standard rate'. From 1 April 2017 the breakpoints for each of these bands have been revised. Also, for vehicles with a list price over £40,000, including factory-fitted options, an additional £320 is payable for the first five years of standard rate payments.

Vehicle Excise Duty*

Band	CO ₂ emissions in grams per kilometre	First year rate		Standard rate
		Petrol [#]	Diesel [†]	
A	0	£0	£0	£0
B	1-50	£10	£25	£145
C	51-75	£25	£110	£145
D	76-90	£110	£135	£145
E	91-100	£135	£155	£145
F	101-110	£155	£175	£145
G	111-130	£175	£215	£145
H	131-150	£215	£540	£145
I	151-170	£540	£870	£145
J	171-190	£870	£1,305	£145
K	191-225	£1,305	£1,850	£145
L	226-255	£1,850	£2,175	£145
M	Over 255	£2,175	£2,175	£145

*Correct at time of issue.

[#]Also applies to diesel vehicles that meet the Real Driving Emissions Step 2 (RDE2).

[†]Applies to vehicles that do not meet the Real Driving Emissions Step 2 (RDE2).

FURTHER INFORMATION

Customer Care Commitment

For added peace of mind, Vauxhall has an innovative Customer Care Commitment that offers the following:

- Three-year vehicle warranty consisting of a one-year/unlimited mileage manufacturer's warranty and a second and third year manufacturer's warranty with a 60,000 miles limitation
- Vauxhall Assistance for 12 months from first registration
- Six years' body panel anti-perforation warranty

Please note: Warranty is only available on vehicles sourced from Vauxhall Motors Limited. Terms and conditions apply – please see your Vauxhall Retailer for details.

Vauxhall Assistance

Vauxhall Assistance is provided automatically with every new Vauxhall for 12 months from first registration and covers everything from accident assistance, roadside recovery and 'at home' service to flat tyres. With Vauxhall Assistance help is literally just a free* phone call away, 24 hours a day, 365 days a year!

Protecting the environment

Vauxhall's commitment to the environment is demonstrated by our products' many environmental awards. For even more information on Vauxhall's efforts to achieve an environmentally sustainable future, and how to dispose of your end-of-life vehicle, see www.vauxhall.co.uk/recycling

Vauxhall Care

This all-inclusive service package is available on Vauxhalls under 10 months old (from date of first registration).

This package offers complete peace of mind for the first 3 years of your Vauxhall's life with fixed monthly payments for the plan duration.

- **3 years' Vauxhall servicing** – covers first, second and third annual services. Including a brake-fluid change in the second service
- **2 years' Vauxhall Roadside Assistance** – first year from us
- **First years' MOT**** – free of charge by your local Vauxhall Retailer

For full terms and conditions and to sign up, visit: vauxhall.co.uk/vauxhallcare

Vauxhall Service Club

Vauxhall Service Club is available for all Vauxhall owners, and it's free to join. Members benefit from the following:

- 15% off Vauxhall Approved Accessories
- Vauxhall's aged 2-3 Years = 15% off parts and labour
- Vauxhall's aged over 3 Years = 25% off parts and labour
- Half price MOT's (NI excluded)
- Free pre-MOT test inspection (NI only)
- Fixed price AdBlue Refills
 - Car = £14.99
 - Van = £24.99
- Access to the Vauxhall Accident Management Programme
- Online service booking available 24/7 with servicing appointments available within 3 days – [Book Online](#)
- Collection and delivery/onward mobility options
- Complimentary 'Wash and Vac' with all routine services[†]
- Vauxhall trained technicians
- Genuine Vauxhall parts
- Minimum 12 months warranty on parts and labour
- Regular newsletters with exclusive offers, discounts and competitions

Terms and conditions apply. To join visit: vauxhall.co.uk/serviceclub

Vauxhall Insurance with added reassurance

Comprehensive cover – Summary of benefits

- Competitive premiums
- Repairs by a Vauxhall-trained technician
- Genuine Vauxhall parts, guaranteed for five years when we repair your car within our Approved Repairer Network
- Free courtesy car as standard when using an Approved Repairer^{††}
- 24 hour claims helpline
- Personal Accident benefit
- Cover for audio equipment
- Windscreen cover

Call for a quote on **0330 678 1130**[‡]

For more product information

For further information on the Vauxhall range or location of your nearest Vauxhall Retailer please call **0345 600 1500**. Alternatively, details can be found on our website at vauxhall.co.uk

*Mobile phone users will be charged at their standard tariff.

**First years' MOT is not available for Northern Ireland.

[†]Participating Retailers only.

^{††}Should your car need repairing following an accident we provide a courtesy car (subject to availability) for the duration of the repair. Only genuine Vauxhall parts are used. Terms and conditions apply.

[‡]Calls may be recorded. Vauxhall Insurance Services is a trading name of Europa Group Limited which is authorised and regulated by the Financial Conduct Authority. Europa Group Limited's Financial Services Register number 309794. Registered as a limited company in England and Wales No 03279177. Registered Office: Europa House, Midland Way, Thornbury, Bristol, BS35 2JX.

Take the next step:



Join us online:

Discover the full Vauxhall range at [vauxhall.co.uk](https://www.vauxhall.co.uk) >

Privacy Policy: For full details please visit [vauxhall.co.uk/privacy](https://www.vauxhall.co.uk/privacy)

The invoice price, including delivery to Retailer, factory-fitted options, accessories fitted by the Retailer and number plates, is subject to VAT. Some feature descriptions in this guide may refer to, and some illustrations may show, optional equipment not included in the standard delivery. The information contained in this guide was accurate at the time of publication. We reserve the right to make changes in design and equipment. Please note that Vauxhall Retailers are not the agents of Vauxhall Motors Limited and are not authorised to bind Vauxhall Motors Limited by any specific or implied undertaking or representation. It is advisable to ensure that your motor insurance policy provides adequate cover for additional fitted options and accessories. The colours in this guide are only approximate actual colours. Illustrated optional equipment is available at extra charge. Availability, technical features and equipment provided on our vehicles can vary by model. For precise information on the equipment provided on our vehicles, please contact your local Vauxhall Retailer.

NEW VIVARO LIFE

Price and Specification Guide | 12 June 2020 | Model Year 2021



CONTENTS

To find the information you want use the links below to navigate around the guide:

[RANGE HIGHLIGHTS >](#)

Explore the New Vivaro Life range and find your perfect model.

[MODELS >](#)

Find all the information you need about your chosen model.

[PRICES >](#)

Find on-the-road recommended retail prices.

[FEATURES/OPTIONS >](#)

Tailor your chosen model to suit your needs with everything from satellite navigation to rear-view camera and parking sensors.

[EXTERIOR COLOURS >](#)

Add some sparkle to your car with a metallic paint.

[WHEELS AND TYRES >](#)

Check out the standard and optional wheel and tyre combinations.

[PERFORMANCE, FUEL ECONOMY AND EMISSIONS >](#)

Know how many miles you will get around town, the CO₂ figures and the 0-62 time.

[DIMENSIONS >](#)

Ensure your car will fit in the garage and know how much luggage you can take for a long weekend away.

[SPECIFICATIONS >](#)

Towing weights, transmissions and other useful details you may need to know.

[ACCESSORIES >](#)

Add some practical touches to your car with our range of quality accessories.

[COMPANY CAR INFORMATION >](#)

Benefit in Kind company car tax, 3 day test drives and P11D.

[FURTHER INFORMATION >](#)

Price protection, vehicle excise duty, our range of additional products and much more.

NEW VIVARO LIFE RANGE HIGHLIGHTS



VX_VIVL_29462.psd



VX_VIVL_29460.psd

EDITION OTR from £34,165

Standard features include:

- Electronic stability programme
- Traction control
- ABS with electronic brakeforce distribution
- Hill start assist
- Driver and front passengers' airbag
- Remote control central deadlocking
- Selective door locking
- Electronic engine deadlock immobiliser
- Multi-function trip computer
- Cruise control with speed limiter
- Air conditioning
- Vauxhall Connect box
- Digital radio/AM/FM stereo radio
- Bluetooth® connectivity
- Steering column mounted audio and phone controls
- Dual front passengers' seat with underseat storage
- Second-row three-passenger foldable 60/40 split bench seat
- Third-row three-passenger foldable bench seat
- Facia-mounted drinks holders
- Nearside and offside sliding side-access glazed doors
- Tailgate with wash/wipe and heated rear window
- Electrically operated front windows
- Electrically adjustable/heated door mirrors
- 16-inch steel wheels

ELITE OTR from £45,910

Features over Edition:

- Electrical operation of sliding side-access doors
- Multimedia Navi Pro infotainment unit with 3D satellite navigation system
- 7-inch colour touchscreen
- Head-up display
- One-touch up/down facility for front windows
- Leather seat trim
- Six-way electrically adjustable heated driver's seat with massage facility
- Four-way electrically adjustable heated passenger's seat with massage facility
- Dual-zone electronic climate control
- Roof-mounted rear heater controls
- Automatic parking heater
- Heat-reflective windscreen
- Rear parcel shelf
- Luggage floor net
- Rear seat back tables
- Rear-view child-minder mirror
- Rear side window blinds
- Remote control security alarm system
- Body-colour front bumper
- Body-colour rear bumper (L1 only)
- Chrome-effect front grille
- Front fog lights
- Rear-view camera
- Rain-sensitive windscreen wipers
- Electro-chromatic rear-view mirror
- LED daytime running lights
- Xenon headlights
- Dark-tinted rear windows
- Electrically folding door mirrors
- Side blind spot alert
- Front and rear parking distance sensors
- Panoramic glass roof
- Curtain airbags for second-and third-row passengers
- Tailgate with separate opening rear window
- Keyless open and start
- 17-inch bi-colour alloy wheels

EDITION



VX_VIVL_29462.psd

EDITION M (MEDIUM) ON-THE-ROAD PRICES

	OTR RRP	CO ₂ (g/km)	Insurance Group
Diesel			
1.5 (120PS) Turbo D S/S	£34,165	170	tba

EDITION L (LONG) ON-THE-ROAD PRICES

Diesel			
1.5 (120PS) Turbo D S/S	£34,525	170	21D

Please note: On-the-road recommended retail prices (RRP) include number plates and delivery to Retailer of £583.33, 12 months' Vehicle Excise Duty and new vehicle first registration fee of £55.00. Excludes fuel and insurance.

S/S = Start/Stop.

FEATURES

Infotainment:

- AM/FM/DAB digital radio
- Bluetooth® audio streaming
- Bluetooth® mobile phone portal
- USB audio connection

Interior convenience/styling:

- Air conditioning
- Multi-function trip computer
- Cruise control with speed limiter
- Vauxhall Connect box
- Steering column mounted audio and phone controls
- Dual front passengers' seat with underseat storage
- Second-row three-passenger foldable 60/40 split bench seat
- Third-row three-passenger foldable bench seat

Exterior convenience/styling:

- Electrically adjustable/heated door mirrors
- Electrically operated front windows
- Nearside and offside sliding side-access glazed doors
- Tailgate with wash/wipe and heated rear window
- Side-protection mouldings

Safety/security:

- Driver and front passenger's airbags
- Driver and front passenger's curtain and side-impact airbags
- Height-adjustable lap and diagonal inertia-reel seatbelts
- Electronic stability programme with traction control
- Anti-lock braking system
- Tyre pressure monitoring system
- Hill start assist
- Daytime running lights
- Remote control central deadlocking
- Selective door locking
- Electronic engine deadlock immobiliser

ELITE



VX_VIVL_29460.psd

ELITE M (MEDIUM) ON-THE-ROAD PRICES

	OTR RRP	CO ₂ (g/km)	Insurance Group
Diesel			
2.0 (180PS) Turbo D S/S automatic	£45,910	198	26E

ELITE L (LONG) ON-THE-ROAD PRICES

	OTR RRP	CO ₂ (g/km)	Insurance Group
Diesel			
2.0 (150PS) Turbo D S/S	£46,560	196	25E
2.0 (180PS) Turbo D S/S automatic	£46,890	199	26E

Please note: On-the-road recommended retail prices (RRP) include number plates and delivery to Retailer of £583.33, 12 months' Vehicle Excise Duty and new vehicle first registration fee of £55.00. Excludes fuel and insurance.

S/S = Start/Stop.

FEATURES

Infotainment:

- Multimedia Navi Pro
 - Fully integrated European sat nav system
 - 7-inch colour touchscreen
 - Voice control
 - AM/FM/DAB digital radio
 - Bluetooth® audio streaming
 - Bluetooth® mobile phone portal
 - USB audio connection
 - Second USB charging connection
 - Four speakers

Interior convenience/styling:

- Leather seat trim
- Six-way electrically adjustable heated driver's seat with massage facility
- Four-way electrically adjustable heated single front passenger's seat with massage facility
- Second-row three-passenger foldable 60/40 split bench seat
- Third-row three-passenger foldable 60/40 split individually sliding bench/single seat
- Dual-zone electronic climate control
- Roof-mounted rear heater controls
- Automatic parking heater
- Electro-chromatic rear-view mirror
- Head-up display
- Multi-function trip computer
- Cruise control with speed limiter
- Electric parking brake
- Vauxhall Connect box
- Steering column mounted audio and phone controls
- Rear-view child-minder mirror
- Rear seat back tables
- Rear side window blinds
- Rear parcel shelf
- Luggage floor net

Exterior convenience/styling:

- Heat-reflective windscreen
- Front fog lights
- Panoramic glass roof
- Rear-view camera
- Rain-sensitive windscreen wipers
- Xenon headlights.
- Keyless entry/engine start/stop
- Electrically adjustable/heated door mirrors
- Electrically folding door mirrors
- Electrically operated front windows with one-touch facility
- Nearside and offside sliding side-access glazed doors
- Hands-free electrical operation of sliding side-access doors
- Tailgate with wash/wipe and heated opening rear window
- Body-colour front bumper
- Body-colour rear bumper (L1 only)
- Chrome-effect front grille
- Side-protection mouldings
- 17-inch bi-colour alloy wheels

Safety/security:

- Side blind spot alert
- Driver and front passenger's airbags
- Curtain airbags for second- and third-row passengers
- Height-adjustable front lap and diagonal inertia-reel seatbelts
- Electronic stability programme with traction control
- Anti-lock braking system
- Hill start assist
- LED daytime running lights
- Remote control central deadlocking
- Selective door locking
- Electronic engine deadlock immobiliser
- Remote control security alarm system

NEW VIVARO LIFE PRICES

	Pack Code	Fuel Type	Price (£)	VAT (£)	Total (£)	On-the-road RRP (£)	Financial Year 2020/21 BiK 20% (£)	WLTP Combined CO ₂ (g/km)# - pack code	Insurance Groups
EDITION M (MEDIUM)									
1.5 (120PS) Turbo D	8C06 I4LW	Diesel	27,391.67	5,478.33	32,870.00	34,165.00	207.00	170	tba
EDITION L (LONG)									
1.5 (120PS) Turbo D	8C06 I4L1	Diesel	27,691.67	5,538.33	33,230.00	34,525.00	209.23	170	21D
ELITE M (MEDIUM)									
2.0 (180PS) Turbo auto	8NZ6 ML8W	Diesel	36,541.67	7,308.33	43,850.00	45,910.00	274.72	198	26E
ELITE L (LONG)									
2.0 (150PS) Turbo	8NZ6 MPQ1	Diesel	37,083.33	7,416.67	44,500.00	46,560.00	278.72	196	25E
2.0 (180PS) Turbo auto	8NZ6 ML81	Diesel	37,358.33	7,471.67	44,830.00	46,890.00	280.77	199	26E

New Vivaro Life's petrol and diesel engines meet the Real Driving Emissions Step 2 (RDE2) standards.

WLTP Combined CO₂ (g/km) figures, valid 3 March 2020, are based on a configured vehicle as per pack code for UK with no options fitted.

#Fuel consumption and CO₂ figures are determined according to the WLTP test cycle. CO₂ figures, BiK values and RRP pricing shown above are for a standard vehicle without any additional optional equipment. CO₂ figures are used to calculate Vehicle Excise Duty (VED) for the first registration of the vehicle and BiK. The addition of optional extras could increase the certified CO₂ emission output. This in turn may affect the amount of VED payable upon registration, and, for company car drivers, the P11D value and the amount of Benefit in Kind (BiK) tax payable. Figures shown are for comparison purposes and should only be compared to the fuel consumption and CO₂ values of other cars tested to the same technical standard. The fuel consumption achieved, and CO₂ produced, in real world conditions will depend upon a number of factors including, but not limited to: the accessories fitted (pre and post registration); variations in weather; driving styles and vehicle load. The WLTP (Worldwide Harmonised Light Vehicles Test Procedure) is used to measure fuel consumption and CO₂ figures. Full data relating to WLTP test cycles can be found at: www.vauxhall.co.uk/wltp

Please note: On-the-road recommended retail prices (RRP) include number plates and delivery to Retailer of £700.00 (inc. £116.67 VAT), 12 months' Vehicle Excise Duty and new vehicle first registration fee of £55.00. Excludes fuel and insurance. Company Car Benefit in Kind (BiK) rates are monthly based on the standard paint price.

FEATURES/OPTIONS

SEATING

	Option code	Edition	Elite	Price (£) exc. VAT	Price (£) inc. VAT
Driver's seat • Reach • Backrest recline • Padded head restraint		●			
Dual front passengers' seat with underseat storage • Fixed position bench seat and backrest • Height-adjustable front padded head restraints		●			
Power driver's seat • Height • Reach • Backrest recline • Lumbar adjustment • Driver's seat armrest • Padded head restraint • Massage functions • Driver's seat memory function, including door mirrors			●		
Single front passenger's seat • Reach • Backrest recline • Padded head restraint • Folding backrest • Passenger's seat armrest • Massage functions • Driver's seat memory function, including door mirrors			●		

REAR SEATING

Second and third-row seating • Second-row three-passenger foldable 60/40 split bench seat • Third-row three-passenger foldable bench seat		●			
• Second-row three-passenger foldable 60/40 split bench seat			●		
• Third-row three-passenger foldable 60/40 split individually sliding bench /single seat			●		
• Two second-row individual swivelling seats	AW2		○	666.67	800.00
Foldable table on rails – Only in conjunction with AWM and AW2	TRD		○	412.50	495.00
Seat trim • Curitiba Tritone Grey fabric		●			
• Carla black leather			●		

● = Standard equipment. ○ = Optional at extra cost. N/C = No-cost option.

FEATURES/OPTIONS

SAFETY

	Option code	Edition	Elite	Price (£) exc. VAT	Price (£) inc. VAT
Driver Safety Pack <ul style="list-style-type: none"> • Semi-adaptive cruise control • Forward collision alert with automatic emergency braking and pedestrian detection • 3.5-inch colour information display 	B26		○	375.00	450.00
Airbag Driver and front passengers airbag: <ul style="list-style-type: none"> • Driver and front passenger's airbag with deactivation switch • Driver and front passengers' curtain and side-impact airbags 		●			
Driver and front passenger's airbags: <ul style="list-style-type: none"> • Driver and front passenger's airbag with deactivation switch • Driver and passenger's side-impact airbags • Full-length curtain airbags (first-, second- and third-row seating) 			●		
Stability Electronic Stability Programme-plus (ESP-plus) with traction control – Works in conjunction with the vehicle's electronic braking and engine systems to keep the vehicle stable in many different situations. ESP monitors a variety of inputs to determine when the vehicle starts to lose traction, it can then immediately respond by varying the brake pressure between up to three wheels and adjust the engine output to help correct the loss of traction and improve stability.		●	●		
Tyre pressure <ul style="list-style-type: none"> • Tyre pressure monitoring system 		●	●		
Braking Four-channel Anti-lock Braking System (ABS) – Prevents the vehicle's wheels from locking up under heavy braking by momentarily reducing brake pressure at the appropriate wheel, ensuring that you can maintain control of the steering. Emergency brake assist – When emergency braking is detected the vehicle automatically applies the maximum possible braking assistance. Electronic brakeforce distribution – Automatically apportions the optimum braking force to each wheel. Hill start assist – Briefly maintains rear brake pressure to stop the vehicle rolling back on an incline.		●	●		

● = Standard equipment. ○ = Optional at extra cost.

FEATURES/OPTIONS

SECURITY

	Option code	Edition	Elite	Price (£) exc. VAT	Price (£) inc. VAT
Features • Electronic engine deadlock immobiliser • Steering column lock • Lockable fuel filler cap • Anti-theft spare wheel cradle		●	●		
Remote control door locking • Remote control door locking • Two keys with integral remote • Door deadlocks • Selective door locking		●	●		
Keyless open and start • Keyless open and start			●		
Security alarm system • System monitors doors, tailgate, bonnet and the passenger compartment	PS6	○	●	175.00	210.00

● = Standard equipment. ○ = Optional at extra cost.

FEATURES/OPTIONS

DRIVER ASSISTANCE

	Option code	Edition	Elite	Price (£) exc. VAT	Price (£) inc. VAT
Visibility Pack <ul style="list-style-type: none"> • Heat-reflective windscreen • Rain-sensitive windscreen wipers 	Y74	○	●	200.00	240.00
Driver Assistance Pack <ul style="list-style-type: none"> • Lane keep assist with lane departure warning • Speed Limit Information/Intelligent Speed Adaptation • Driver drowsiness system • White text Instrument panel • High beam assist 	E9A		○	500.00	600.00
Electric Pack <ul style="list-style-type: none"> • Foldable electrically adjustable/heated door mirrors – When front and rear parking distance sensors are fitted. • 12v socket in saloon area • Remote key with three buttons • Electrically operated front windows with one-touch up/down facility 		●	●		
Head-up display – Projects key information onto the windscreen so that the driver’s eyes remain on the road at all times. The display is adjustable for height and brightness.			●		
Multi-function trip computer <ul style="list-style-type: none"> • Trip odometer • Vehicle range based on remaining fuel • Average speed • Average fuel economy • Instantaneous fuel economy • Driving time 		●	●		
Parking assistance <ul style="list-style-type: none"> • Rear parking distance sensors 	UD7	○		183.33	220.00
<ul style="list-style-type: none"> • Front and rear parking distance sensors • Side blind spot alert • Front fog lights • Electrically folding door mirrors 	UD5	○	●	541.67	650.00
<ul style="list-style-type: none"> • Rear-view camera – requires UD7. Not available with Multimedia infotainment system (i05) 	UVC	○		tba	tba
<ul style="list-style-type: none"> • Panoramic rear-view camera 			●		
<ul style="list-style-type: none"> • Electric parking brake – Centre console switch in lieu of handbrake lever 			●		
Cruise control, speed limiter		●	●		
Instrumentation <ul style="list-style-type: none"> • Speedometer • Rev counter • Fuel gauge with low fuel warning light • Fuel economy gauge • Coolant temperature warning light 		●	●		

● = Standard equipment. ○ = Optional at extra cost.

FEATURES/OPTIONS

DRIVER ASSISTANCE CONTINUED

	Option code	Edition	Elite	Price (£) exc. VAT	Price (£) inc. VAT
<p>IntelliGrip Pack</p> <p>For those drivers who regularly take their vehicle off road, this pack helps the driver cope with whatever conditions they encounter. IntelliGrip traction control is designed to increase grip in difficult conditions without the additional weight of a conventional four-wheel drive system. It's an innovative grip control system that provides improved traction on certain terrain and conditions through a combination of optimised torque distribution and limited wheel spin, managed through the electronic stability programme.</p> <ul style="list-style-type: none"> • IntelliGrip: A choice of five selectable modes to suit the driving conditions: ESP on, ESP off, snow, mud, sand - Only available when 17-inch wheels are specified for Edition models. 	H4H	○	○	200.00	240.00

COMFORT AND CONVENIENCE

<p>Comfort</p> <ul style="list-style-type: none"> • Reach and rake-adjustable steering wheel • Facia-mounted gear lever • Floor-mounted handbrake lever • Inertia-reel lap and diagonal seatbelts • Height-adjustable outer front seatbelts • Height-adjustable padded head restraints • Rear parcel shelf 		●			
<ul style="list-style-type: none"> • Load area restraint net • Load area cover • Luggage floor net • Rear seat back tables • Rear-view child-minder mirror • Rear side-window blinds • Torch stowed in rear luggage area panel • 220 volt socket behind driver's seat 			●		
Leather-covered steering wheel			●		

● = Standard equipment. ○ = Optional at extra cost.

FEATURES/OPTIONS

INFOTAINMENT

	Option code	Edition	Elite	Price (£) exc. VAT	Price (£) inc. VAT
Radio BT Onboard features: <ul style="list-style-type: none"> • AM/FM stereo radio • DAB Digital radio • RDS with Traffic Programme • 20 watts per channel output • Four speakers Media connections: <ul style="list-style-type: none"> • USB connection with iPod control • Bluetooth® A2DP audio streaming (Advanced Audio Distribution Profile) Mobile phone portal: <ul style="list-style-type: none"> • Bluetooth® connectivity • Handsfree calls via steering wheel controls • Vehicle microphone 		●			
Multimedia Onboard features: <ul style="list-style-type: none"> • 7-inch colour touchscreen • AM/FM stereo radio with 25 Station presets • DAB Digital radio • RDS with Traffic Programme • 20 watts per channel output • Four speakers Media connections: <ul style="list-style-type: none"> • USB connection with iPod control • Bluetooth® A2DP audio streaming (Advanced Audio Distribution Profile) Mobile phone portal: <ul style="list-style-type: none"> • Bluetooth® connectivity • Handsfree calls via steering wheel controls • Vehicle microphone • Phone book access – Contacts/last calls/missed calls etc. are mirrored on the display and are easily navigated using the touchscreen (features dependent on mobile phone). • Bluetooth® connectivity • Handsfree calls via steering wheel controls • Vehicle microphone Smartphone interface: <ul style="list-style-type: none"> • Apple CarPlay™ • Android Auto™ – Smartphone projection that allows operations via voice command, touchscreen and buttons to control apps and music playback. 	i05	○		400.00	480.00

● = Standard equipment. ○ = Optional at extra cost.

FEATURES/OPTIONS

INFOTAINMENT CONTINUED

	Option code	Edition	Elite	Price (£) exc. VAT	Price (£) inc. VAT
Multimedia Navi Pro Onboard features: <ul style="list-style-type: none"> • 7-inch colour touchscreen • AM/FM stereo radio with 15 Station presets • DAB Digital radio • RDS with Traffic Programme • 20 watts per channel output • Ten speakers Navigation features: <ul style="list-style-type: none"> • Satellite navigation system • 3D street level mapping • European coverage • Structured or one-box destination entry • Points-of-interest search • Eco routing • Map updates via USB Wi-fi enabled connected navigation features: <ul style="list-style-type: none"> • Three years subscription to TomTom Live* • On-line navigation services provided by TomTom® include: <ul style="list-style-type: none"> • TomTom® live traffic updates • Local weather information • Nearby fuel station display • Local address search and contact info for points of interest Media connections: <ul style="list-style-type: none"> • USB connection with iPod control • Bluetooth® A2DP audio streaming (Advanced Audio Distribution Profile) Mobile phone portal: <ul style="list-style-type: none"> • Bluetooth® connectivity • Handsfree calls via steering wheel controls • Vehicle microphone • Phone book access – Contacts/last calls/missed calls etc. are mirrored on the display and are easily navigated using the touchscreen (features dependent on mobile phone). Smartphone interface: <ul style="list-style-type: none"> • Apple CarPlay™ • Android Auto™ – Smartphone projection that allows operations via voice command, touchscreen and buttons to control apps and music playback. 			●		
Additional features <ul style="list-style-type: none"> • Steering column mounted audio controls • Flexible roof-mounted aerial 		●	●		
Four speakers		●			
Ten speakers (HiFi Pack)			●		

*Additional terms and conditions apply to connected services, including customer acceptance of location sharing prior to activation.

● = Standard equipment.

FEATURES/OPTIONS

HEATING AND VENTILATION

	Option code	Edition	Elite	Price (£) exc. VAT	Price (£) inc. VAT
Air conditioning • Air recirculation facility • Pollen filter • Illuminated controls • Chilled glovebox facility		●	●		
Electronic climate control • LCD temperature display • Automatic air direction and fan speed with manual override • Illuminated controls • Pollen filter • Chilled glovebox facility			●		
Rear air conditioning • Multi-function overhead panel with separate controls for the rear cabin • Six multi-function air nozzles • Fixed side air vents			●		
Automatic parking heater			●		

LOAD ACCESS

Nearside and offside access Nearside and offside sliding side-access door with fixed windows: • Fixed window to nearside side-access door • Fixed window to offside side-access door		●	●		
Handsfree electrically operated sliding side-access doors: • Keyless open and start • Auto anti-dazzle rear-view mirror			●		
Rear access Rear glazed doors: • Glazed rear doors • 90°/180° opening • Heated rear windows with wash/wipe facility	J1X	○		200.00	240.00
Tailgate: • Glazed tailgate • Heated rear windows with wash/wipe facility		●			
• Glazed tailgate with opening window • Heated rear windows with wash/wipe facility			●		
Vertical safety net	APT	○	○	100.00	120.00

● = Standard equipment. ○ = Optional at extra cost.

FEATURES/OPTIONS

EXTERIOR LIGHTING

	Option code	Edition	Elite	Price (£) exc. VAT	Price (£) inc. VAT
Standard lighting • Lights-on audible warning • Reversing lights • Hazard warning lights • Rear fog lights • High-level brake light • Side-repeat indicators • Daytime running lights – LED on Elite models.		●	●		
• Xenon headlights			●		

EXTERIOR CONVENIENCE/STYLING

Appearance Pack • Body-colour front bumper • Body-colour rear bumper (L1 only) • Body-colour mirror housings and door handles • Body-colour side-protection mouldings • Chrome-effect front grille • Front fog lights • LED daytime running lights			●		
Full-length panoramic glass sunroof with manually-sliding sunblinds			●		
Dark-tinted rear glazing (opacity level approximately 70%)	AKO	○	●	100.00	120.00
Conversions Connector for conversions	WRF	○		90.00	108.00

● = Standard equipment. ○ = Optional at extra cost.







FEATURES/OPTIONS

TOWING

	Option code	Edition	Elite	Price (£) exc. VAT	Price (£) inc. VAT
 <p>Tow bar</p> <ul style="list-style-type: none">• Removable monoblock towing ball without tool• Provison for tow bar • Towing connector <p>VX_VIV_29614.tif</p>	VQ9	O	O	250.00	300.00

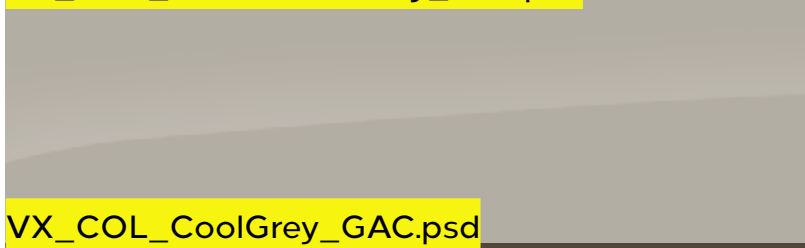
O = Optional at extra cost.

EXTERIOR COLOURS

		Edition	Elite	Price (£) exc. VAT	Price (£) inc. VAT
Solid	 Jade White (G2o) VX_COL_White_Jade_G2o.psd	●	●		
	 Moonstone Grey metallic (G4o) VX_COL_MoonstoneGrey_G4o.psd				
Two-coat	 Cool Grey metallic (GAC) VX_COL_CoolGrey_GAC.psd				
	 Rich Oak Brown metallic (GoJ) VX_COL_RichOakBrown_GoJ.psd				
	 Quartz Grey metallic (G4i) VX_COL_QuartzGrey_G4i.psd				
	 Amber Red metallic (GoX) VX_COL_AmberRed_GoX.psd	○	○	500.00	600.00
	 Diamond Black metallic (G7o) VX_COL_DiamondBlack_G7o.psd				

The colours reproduced may vary slightly from the actual paint colour. As a result they should be used as a guide only. Your Vauxhall Retailer has a comprehensive display of our paint samples.

● = Standard equipment. ○ = Optional at extra cost.

WHEELS AND TYRES



	Option code	Edition	Elite	Price (£) exc. VAT	Price (£) inc. VAT
All-season tyres • 215/60 R 17 – Only available when 17-inch wheels are specified.	Q40	○	○	166.67	200.00
Tyre inflation kit		●	●		
 16-inch steel wheels with centre cap • 215/65 R 16 tyres <small>VX_VIV_29655.psd</small>		●			
 17-inch diamond-cut alloy wheels • 215/60 R 17 tyres • Locking wheel bolts <small>VX_VIV_29648_WQX.psd</small>			●		
 17-inch steel wheels with centre cap • 215/60 R 17 tyres <small>VX_VIV_29656.psd</small>	RS9	○		166.67	200.00

● = Standard equipment. ○ = Optional at extra cost. N/C = No-cost option.

PERFORMANCE, FUEL ECONOMY AND EMISSIONS

	Performance (manufacturer's figures)		Fuel economy mpg (litres/100km)#		CO ₂ emissions g/km#		Vehicle Excise Duty*		BiK rates from - 2020/21 tax year
	Maximum speed (mph)	Acceleration 0-60mph (sec)	Combined Low	Combined High	Combined Low	Combined High	First year rate	Standard rate	
1.5 (120PS) Turbo D	100	14.3	39.2 (7.2)	47.1 (6.0)	170	189	£540	£145	37%
2.0 (150PS) Turbo D	105	12.0	35.3 (8.0)	41.5 (6.8)	194	210	£1,305	£145	37%
2.0 (180PS) Turbo D auto	105	10.4	34.8 (8.1)	40.6 (7.0)	199	213	£1,305	£145	37%

Tyre Rating

Tyre size	Type	Fuel efficiency group	Wet grip performance	External noise	
				Measured (dB)	Group
215/65 R 16	Summer	C	A	72	
215/60 R 17	Summer IntelliGrip	C	A	72	
215/60 R 17	All season	E	B	71	

Tyre rating according to EU Regulation 1222/2009

#Figures shown are for comparison purposes and should only be compared to the fuel consumption and CO₂ values of other cars tested to the same technical standard. The fuel consumption achieved, and CO₂ produced, in real world conditions will depend upon a number of factors including, but not limited to: the accessories fitted (pre and post registration); variations in weather; driving styles and vehicle load. The WLTP (Worldwide Harmonised Light Vehicles Test Procedure) is used to measure fuel consumption and CO₂ figures. The CO₂ figures display a range to reflect the highest value for the highest emitting version with all available options added, through to a minimum value to represent the lowest emitting version in standard specification.

*Correct at time of publication.

DIMENSIONS

Loadspace Dimensions millimetres (inches)	M (MEDIUM)	L (LONG)
Maximum load length – Passenger’s seat folded	3161 (124.5)	3511 (138.2)
Maximum load length – Behind front seats	2413 (95.0)	2763 (108.8)
Maximum width	1618 (63.7)	1618 (63.7)
Width between wheel arches	1228 (48.3)	1228 (48.3)
Maximum height	1337 (52.6)	1339 (52.7)
Loadspace Access millimetres (inches)		
Side door aperture height	1181 (46.5)	1181 (46.5)
Side door aperture width	933 (36.7)	933 (36.7)
Rear door aperture height	1181 (46.5)	1181 (46.5)
Rear door aperture width	1212 (47.7)	1212 (47.7)
Loading height – Maximum	653 (25.7)	664 (26.1)
Loading height – Minimum	584 (23.0)	584 (23.0)

Loadspace Volumes cu.m (cu.ft.)	M (MEDIUM)	L (LONG)
Maximum volume to roof level	3.9 (137.7)	4.5 (158.9)
Maximum volume to seat back level	3.0 (105.9)	3.5 (123.6)
Exterior dimensions millimetres (inches)		
Overall length	4956 (195.1)	5306 (208.9)
Width – including door mirrors	2204 (86.8)	2204 (86.8)
Width – excluding door mirrors	1920 (75.6)	1920 (75.6)
Height – manual models	1925 (75.8)	1925 (75.8)
Height – automatic models	1935 (76.2)	1935 (76.2)
Wheelbase	3275 (129.0)	3275 (129.0)
Front overhang	881 (34.7)	881 (34.7)
Rear overhang	803 (31.6)	1153 (45.4)

SPECIFICATIONS

Transmission

Six-speed manual gearbox:

- Front-wheel drive • Transverse engine/gearbox

Eight-speed automatic transmission:

- Front-wheel drive • Transverse engine/gearbox

Replacing the traditional lever, the automatic transmission selection-mode dial/drive wheel is an innovative solution that is both elegant and intuitive.

By simply twisting the dial, the following modes can be selected:

- Park, for when the vehicle is stationary and the wheels are locked
- Drive, for automatic forward motion
- Neutral, for when the vehicle is stationary, wheels are free
- Reverse, for automatic backward motion

For an extra experience of dynamism, the shift paddles for automatic transmissions are located behind the steering wheel, offering drivers an extra level of control that is highly ergonomic and intuitive. The shift paddles function in the following way:

- To go up a gear, the driver must pull the right lever towards themselves
- To go down a gear, the driver must pull the left lever towards themselves – Please note: only consecutive gear changes are possible.

Steering

- Hydraulic power-assisted rack and pinion system
- Energy absorbing steering column
- Turning circle (kerb-to-kerb): 12.4m (40.7ft.)

Brakes

Front ventilated disc brakes:

- 304mm x 28mm

Rear disc brakes:

- 290mm x 12mm

Fuel tank capacity

- 70 litres (15.4 gallons)

AdBlue® tank capacity

- 22.5 litres (4.95 gallons)

Start/stop technology

New Vivaro Life's Start/Stop system, fitted as standard to all models offers real benefits by improving fuel economy and reducing CO₂ emissions, particularly in town. It does this by automatically stopping the engine when you come to a standstill, and then restarting as you prepare to move off.

Before automatically stopping the engine a number of system checks are carried out to ensure that it is both safe and practical to do so. To ensure safety, the driver must depress the clutch pedal, shift in to neutral, and then release the clutch pedal. System checks carried out before Auto Stop activates include:

- Start/Stop system is not manually deactivated via the facia button
- Sufficient brake vacuum is available to prevent the car rolling down an incline
- Battery is in good condition and charged
- Outside air temperature and engine temperature are above specified minima
- Electronic climate control (where fitted) is not in maximum heating or maximum cooling mode
- Self-cleaning function of the diesel particulate filter is not active

If all of these conditions are satisfied then the vehicle will Auto Stop.

When you are ready to pull away from standstill, Auto Restart is activated by depressing the clutch pedal.

Whilst at a standstill the vehicle is continually monitored. If necessary, the engine will automatically be restarted. Conditions that would initiate an Auto Restart include:

- Low battery level
- Brake vacuum below specified minimum
- Start/Stop system is manually deactivated
- Stationary for 5.5 minutes

Weights and Towing Data kg

	Gross vehicle weight	Maximum towing weights Trailer with brakes
LIFE EDITION M (MEDIUM) EURO 6D TEMP (6.2)		
1.5 (100PS) Turbo D S/S	2830	1400
LIFE ELITE M (MEDIUM) EURO 6D TEMP (6.2)		
2.0 (150PS) Turbo D S/S	3100	1900
2.0 (180PS) Turbo D S/S automatic	3100	1800
LIFE EDITION L (LONG) EURO 6D TEMP (6.2)		
1.5 (120PS) Turbo D S/S	2830	1400
LIFE ELITE L (LONG) EURO 6D TEMP (6.2)		
2.0 (150PS) Turbo D S/S	3100	1900
2.0 (180PS) Turbo D S/S automatic	3100	1800

S/S = Start/Stop.

Gross vehicle weight is the total permissible weight of the vehicle including passengers and their luggage. The maximum roof rack loading should not exceed 170kg on all models. The maximum towing weights are based on the ability of the car, with two occupants of 75kg each, to restart on a 12% gradient, which is approximately 1 in 8.3, at sea level. The permitted trailer load applies up to the specified incline and up to an altitude of 1000 metres above sea level. The permissible gross train weight decreases by 10% for every 1000 metres of additional altitude. Any extra weight, such as luggage or additional passengers, should be deducted from the maximum towing weight. Always fit Vauxhall towing attachments and accessories available from your Vauxhall Retailer. They are designed specifically for Vauxhall models and carry a 12-month guarantee. During trailer towing do not exceed a maximum speed of 60mph. This speed limit is also applicable in countries with higher permitted speeds for trailer-vehicle combinations. Pay attention to the local speed limits. For trailers with low driving stability and caravans the use of an oscillation damper is strongly recommended.

DIESEL ENGINES

Engine	1.5 (120PS) Turbo D Start/Stop BlueInjection	2.0 (150PS) Turbo D Start/Stop BlueInjection
Capacity	1499cc	1997cc
Maximum power	120PS (88kW) @ 3500rpm	150PS (110kW) @ 3500rpm
Maximum torque	300Nm (221 lb.ft.) @ 1750rpm	370Nm (273 lb.ft.) @ 2000rpm
Configuration	4 cylinders, 4 valves per cylinder, double overhead camshafts	4 cylinders, 4 valves per cylinder, double overhead camshafts
Emission compliance	Euro 6d	Euro 6d
Service interval	25,000 miles or 2 years (whichever occurs sooner)	30,000 miles or 2 years (whichever occurs sooner)

Engine	2.0 (180PS) Turbo D Start/Stop BlueInjection
Capacity	1997cc
Maximum power	180PS (130kW) @ 3500rpm
Maximum torque	400Nm (295 lb.ft.) @ 2000rpm
Configuration	4 cylinders, 4 valves per cylinder, double overhead camshafts
Emission compliance	Euro 6d
Service interval	30,000 miles or 2 years (whichever occurs sooner)

ACCESSORIES

CHILD SEATS¹ Total (inc. VAT)

BABY-SAFE ² – 0-13kg/birth to 15 months	£152
– ISOFIX base	£263
DUO ISOFIX ² – 9-18kg/9 months to 4 years	
with top tether kit	£402
KID ² – 15-36kg or 4 to 12 years	£182

SAFETY

Safety Pack – first aid kit, hi-visibility vest and small warning triangle	£28
Warning triangle – Small	£10
Warning triangle – Large	£18
First aid kit	£12
Hi-visibility vest	£7

SECURITY

Privacy Shades – Side Rear Windows (tilt/turn window) – set of 2	£46
Privacy Shades – Side Rear Windows (electric window) – set of 2	£46
Privacy Shades – Quarter Side Rear Window Set of 2	£46
Privacy Shade – Rear Window	£46

FLEXCONNECT RANGE Total (inc. VAT)

FlexConnect bracket	£28
FlexConnect hook	£32
FlexConnect coat hanger	£34
FlexConnect folding table	£77
FlexConnect iPad Mini cradle	£109
FlexConnect iPad (1-4) cradle	£118
FlexConnect iPad Air cradle	£117
FlexConnect Samsung Galaxy cradle	£107

PRACTICAL

Wind Deflectors	£68
Smokers pack	£48
Cargo Net – L2/L3	£26
Fragrance diffuser	£22
Fragrance cartridge	£17
USB charger – 2 front and 2 rear ports	£20

PROTECTION Total (inc. VAT)

Carpet Mat – 1st row	£65
Carpet Mat – 2nd row	£53-£59
Carpet Mat – 3rd row	£53
Rubber Mat – 1st Row	£80
Splash Guards – front and rear	£121
Front parking sensors	£365
Rear parking sensors	£369
Boot Liner – L2/L3	£73
Boot Liner (carpet) – L2/L3	£36-£50
Boot Cover	£49
Rear Seat Cover	£37
Rear Bumper Protector	£34

TRANSPORT SYSTEMS Total (inc. VAT)

Aluminium Roof Bar – single (2 or 3 needed)	£122
Roof carriers (requires base carrier)	
Bike roof carrier – Thule Expert 298	£125
Kayak roof carrier – Thule 837	£172
Ski roof carrier (up to 4 pairs)	
Thule 7324	£134
Ski roof carrier (up to 6 pairs)	
Thule 7326	£176
Hard shell roof boxes (requires base carrier)	
Thule Ocean 80 (320 litre/1330 x 860 x 370mm)	£154
Thule Ocean 200 (450 litre/1750 x 820 x 450mm)	£323
Thule Motion 800 (460 litre/2050 x 840 x 450mm)	from £463
Thule Touring 200 (400 litre/1720 x 820 x 450mm)	£338
Thule Touring 700 (430 litre/1960 x 780 x 430mm)	£384

Please note: Prices shown are fully fitted and painted, where applicable and include VAT. Please check with your local Vauxhall Retailer for details. It is advisable to ensure your insurance policy is adequate to cover additional fitted accessories. Prices correct at time of publication.

¹Restrictions apply to the use of child seats, please consult your Vauxhall Retailer or request a copy of the Child seats brochure. ²Without transponder.

COMPANY CAR DRIVER AND FLEET INFORMATION

High spec, low P11D

As a business and company car driver, you'll find all of our models are seriously fit for fleet; we're talking very low P11D values, generous standard specification and high-tech engines designed for great fuel economy and low emissions – and that's just to get you started.

To get access to even more spec as standard, simply take a step up in the range – low P11D values will continue to apply.

Drivers and businesses all have unique requirements and by taking advantage of low whole-life costs and low company car driver taxation you can get in the driving seat with the spec to suit.

Company Car Driver Free 3 Day Test Drive

Our free* 3 Day Test Drive programme is open to all Company Car Drivers which allows you to choose any model in the current Vauxhall line-up (exclusions apply). With full insurance cover provided, it gives you a meaningful length of time to make an informed decision about your next company car.

Search Vauxhall 3DTD to book your FREE* test drive or click the link the below:

[Vauxhall 3 Day Test Drive](#)

*The free 3 Day Test Drive programme is open to Company Car Drivers and Fleet Decision Makers. Available for UK Mainland only. Terms and conditions apply. Full terms and conditions can be found at vauxhallfleet.co.uk/testdrive/index/terms.

Benefit in kind company car taxation**

The car benefit charge will be the car's list price (including VAT, options and accessories fitted, delivery to Retailer and number plates, but excluding Vehicle Excise Duty and new vehicle first registration fee) multiplied by the percentage charge for the CO₂ emissions band in which the car falls (see table opposite). Multiply this figure by your personal income tax rate (20%[†] for Basic Rate, 40%[†] for Higher Rate) to calculate your annual benefit in kind tax liability.

Example:

New Vivaro Life Edition L 1.5 (120PS) Turbo D Start/Stop (CO ₂ emissions 170g/km)	
On-the-road RRP	£34,525.00
Deduct: Vehicle Excise Duty	(£540.00)
New vehicle first registration fee	(£55.00)
Effective list price	£33,930.00
Add: Optional two-coat metallic paint	£600.00
List price for tax purposes (P11D value)	£34,530.00
Car benefit charge 2020–21 tax year (37%)	£12,776.00
Benefit in kind tax liability (2020–21 tax year)	
Basic Rate (20%) tax payer	£2,555.20
Higher Rate (40%) tax payer	£5,110.40

**Please note this Price Guide provides taxation information as a guide only. Vauxhall does not provide taxation guidance. Drivers should always take professional advice on their own tax position.

[†]Excludes residents of Scotland.

BIK FOR SCOTTISH RESIDENTS

Effective 6 April 2018 the Scottish Government have introduced their own BiK taxation structure. This only applies to Company Car Drivers that are Scottish taxpayers. HMRC will determine whether or not an individual is a Scottish taxpayer based on where their main place of residence is.

The BiK rates for Scotland are:

- Over £12,500–£14,549 Starter Rate 19%
- Over £14,549–£24,994 Basic Rate 20%
- Over £24,994–£43,430 Intermediate Rate 21%
- Over £43,430–£150,000 Higher Rate 41%
- Above £150,000 Top Rate 46%

CO ₂ emissions in grams per kilometre	Percentage of cars price to be taxed	
	Non-Diesel ^{††} 2020-21 tax year	Diesel [†] 2020-21 tax year
Up to 50	12%	–
51–54	13%	–
55–59	14%	–
60–64	15%	–
65–69	16%	–
70–74	17%	–
75–79	18%	22%
80–84	19%	23%
85–89	20%	24%
90–94	21%	25%
95–99	22%	26%
100–104	23%	27%
105–109	24%	28%
110–114	25%	29%
115–119	26%	30%
120–124	27%	31%
125–129	28%	32%
130–134	29%	33%
135–139	30%	34%
140–144	31%	35%
145–149	32%	36%
150–154	33%	37%
155–159	34%	37%
160–164	35%	37%
165–169	36%	37%
170+	37%	37%

Fleet Toolbox

Discover the facts in our online Toolbox for both Company Car Drivers and Fleet Decision Makers. The Fleet Toolbox has a host of useful calculators, comparators, interactive listings and information.

Search Vauxhall Fleet Tools or click the link below: [Vauxhall Fleet Tool Box](#)

Contact Vauxhall Fleet

Please contact one of our dedicated sales teams who will be happy to help with your particular enquiry.

Company Car Drivers

Call: 0345 111 2020

Email: company-car@vauxhallinfo.co.uk

Telephone lines are open

– Monday to Friday 8:00am–9:00pm

– Saturday and Sunday 9:00am–6:00pm

Fleet Decision Makers

Depending on the size of your fleet of vehicles, we have a dedicated team to handle your enquiries. The lines are open Monday to Friday excluding Bank Holidays.

1–24 vehicles

Call: 0845 076 2254 (8:30am–5:00pm)

25+ vehicles

Call: 0330 587 8222 (8:30am–5:00pm)

Email: vauxhallfleet@vauxhall.co.uk

Special Vehicles (Police, Fire and Ambulance)

Call: 01582 409999 (8:30am–5:00pm)

Email: vauxhallspecialvehicles@vauxhall.co.uk

^{††}Also applies to diesel vehicles that meet the Real Driving Emissions Step 2 (RDE2). [†]Applies to vehicles that do not meet the Real Driving Emissions Step 2 (RDE2).

To calculate your own personal liability, search: **Vauxhall BiK**, or click the link below:

[Vauxhall BiK Tool](#)

For more information visit www.vauxhall.co.uk/fleet

FURTHER INFORMATION

On-the-road prices

To eliminate uncertainty about hidden costs when buying a new car, Vauxhall publishes on-the-road recommended retail prices (RRP) and these are shown in the pricing tables within this price guide. These prices include VAT, number plates and delivery to Retailer of £700.00 (including £116.67 VAT), 12 months' Government Vehicle Excise Duty (see opposite for details) and the DVLA new vehicle first registration fee of £55.00.*

Please note: The on-the-road recommended retail price (RRP) does not include fuel supplied by the Retailer, motor insurance or any other goods or services supplied by agreement between the Retailer and the customer.

Price protection

Order a new Vauxhall for build in the current model year (as confirmed by your Retailer) for delivery no more than three months in advance and the price you are quoted is the price you pay. This is irrespective of any subsequent price rises between placing your order and delivery of your new car, but you must take delivery as soon as the car is available. Vauxhall Motors Limited is not liable for price adjustments caused by Government changes in the rate of VAT (currently 20%), Vehicle Excise Duty, DVLA new vehicle first registration fee or by any other applicable legislation or regulations.

In the event of an accident

Vauxhall Accident Management helps keep you mobile following an accident. Benefits include vehicle recovery, Vauxhall-approved repairs and contacting your insurer. For more details, visit www.vauxhall.co.uk/AccidentManagement

Free2Move Lease

Whether you're a big company or a small business looking for vehicle financing, Free2Move Lease, our business finance specialists, can deliver exactly what you need.

Free2Move Lease is one of the UK's largest leasing companies and is also a member of the British Vehicle Rental and Leasing Association (BVRLA).

With over 60,000 vehicles in the Free2Move Lease portfolio, Free2Move Lease is able to offer competitive vehicle solutions. In addition, Free2Move Lease also offer innovative connected management of servicing and maintenance.

For further information, please contact your local Vauxhall Retailer or visit www.vauxhall.co.uk/offers-finance/business-leasing.html

Vehicle Excise Duty

The amount of Vehicle Excise Duty (road fund licence) payable on new cars varies depending on the level of carbon dioxide (CO₂) emissions produced by the vehicle. CO₂ emissions are measured in grams per kilometre (g/km) travelled and divided into 13 charging bands shown in the table opposite.

A 'first year rate' of Vehicle Excise Duty is payable on all new cars and in subsequent years the amount payable reverts to the 'standard rate'. From 1 April 2017 the breakpoints for each of these bands have been revised. Also, for vehicles with a list price over £40,000, including factory-fitted options, an additional £320 is payable for the first five years of standard rate payments.

Vehicle Excise Duty*

Band	CO ₂ emissions in grams per kilometre	First year rate		Standard rate
		Petrol [#]	Diesel [†]	
A	0	£0	£0	£0
B	1-50	£10	£25	£145
C	51-75	£25	£110	£145
D	76-90	£110	£135	£145
E	91-100	£135	£155	£145
F	101-110	£155	£175	£145
G	111-130	£175	£215	£145
H	131-150	£215	£540	£145
I	151-170	£540	£870	£145
J	171-190	£870	£1,305	£145
K	191-225	£1,305	£1,850	£145
L	226-255	£1,850	£2,175	£145
M	Over 255	£2,175	£2,175	£145

*Correct at time of issue.

[#]Also applies to diesel vehicles that meet the Real Driving Emissions Step 2 (RDE2).

[†]Applies to vehicles that do not meet the Real Driving Emissions Step 2 (RDE2).

FURTHER INFORMATION

Customer Care Commitment

For added peace of mind, Vauxhall has an innovative Customer Care Commitment that offers the following:

- Three-year vehicle warranty consisting of a one-year/unlimited mileage manufacturer's warranty and a second and third year manufacturer's warranty with a 60,000 miles limitation
- Vauxhall Assistance for 12 months from first registration
- Six years' body panel anti-perforation warranty

Please note: Warranty is only available on vehicles sourced from Vauxhall Motors Limited. Terms and conditions apply – please see your Vauxhall Retailer for details.

Vauxhall Assistance

Vauxhall Assistance is provided automatically with every new Vauxhall for 12 months from first registration and covers everything from accident assistance, roadside recovery and 'at home' service to flat tyres. With Vauxhall Assistance help is literally just a free* phone call away, 24 hours a day, 365 days a year!

Protecting the environment

Vauxhall's commitment to the environment is demonstrated by our products' many environmental awards. For even more information on Vauxhall's efforts to achieve an environmentally sustainable future, and how to dispose of your end-of-life vehicle, see www.vauxhall.co.uk/recycling

Vauxhall Care

This all-inclusive service package is available on Vauxhalls under 10 months old (from date of first registration).

This package offers complete peace of mind for the first 3 years of your Vauxhall's life with fixed monthly payments for the plan duration.

- **3 years' Vauxhall servicing** – covers first, second and third annual services. Including a brake-fluid change in the second service
- **2 years' Vauxhall Roadside Assistance** – first year from us
- **First years' MOT**** – free of charge by your local Vauxhall Retailer

For full terms and conditions and to sign up, visit: vauxhall.co.uk/vauxhallcare

Vauxhall Service Club

Vauxhall Service Club is available for all Vauxhall owners, and it's free to join. Members benefit from the following:

- 15% off Vauxhall Approved Accessories
- Vauxhall's aged 2-3 Years = 15% off parts and labour
- Vauxhall's aged over 3 Years = 25% off parts and labour
- Half price MOT's (NI excluded)
- Free pre-MOT test inspection (NI only)
- Fixed price AdBlue Refills
 - Car = £14.99
 - Van = £24.99
- Access to the Vauxhall Accident Management Programme
- Online service booking available 24/7 with servicing appointments available within 3 days – [Book Online](#)
- Collection and delivery/onward mobility options
- Complimentary 'Wash and Vac' with all routine services[†]
- Vauxhall trained technicians
- Genuine Vauxhall parts
- Minimum 12 months warranty on parts and labour
- Regular newsletters with exclusive offers, discounts and competitions

Terms and conditions apply. To join visit: vauxhall.co.uk/serviceclub

Vauxhall Insurance with added reassurance

Comprehensive cover – Summary of benefits

- Competitive premiums
- Repairs by a Vauxhall-trained technician
- Genuine Vauxhall parts, guaranteed for five years when we repair your car within our Approved Repairer Network
- Free courtesy car as standard when using an Approved Repairer^{††}
- 24 hour claims helpline
- Personal Accident benefit
- Cover for audio equipment
- Windscreen cover

Call for a quote on **0330 678 1130**[‡]

For more product information

For further information on the Vauxhall range or location of your nearest Vauxhall Retailer please call **0345 600 1500**. Alternatively, details can be found on our website at vauxhall.co.uk

*Mobile phone users will be charged at their standard tariff.

**First years' MOT is not available for Northern Ireland.

[†]Participating Retailers only.

^{††}Should your car need repairing following an accident we provide a courtesy car (subject to availability) for the duration of the repair. Only genuine Vauxhall parts are used. Terms and conditions apply.

[‡]Calls may be recorded. Vauxhall Insurance Services is a trading name of Europa Group Limited which is authorised and regulated by the Financial Conduct Authority. Europa Group Limited's Financial Services Register number 309794. Registered as a limited company in England and Wales No 03279177. Registered Office: Europa House, Midland Way, Thornbury, Bristol, BS35 2JX.

Take the next step:



Join us online:

Discover the full Vauxhall range at [vauxhall.co.uk](https://www.vauxhall.co.uk) >

Privacy Policy: For full details please visit [vauxhall.co.uk/privacy](https://www.vauxhall.co.uk/privacy)

The invoice price, including delivery to Retailer, factory-fitted options, accessories fitted by the Retailer and number plates, is subject to VAT. Some feature descriptions in this guide may refer to, and some illustrations may show, optional equipment not included in the standard delivery. The information contained in this guide was accurate at the time of publication. We reserve the right to make changes in design and equipment. Please note that Vauxhall Retailers are not the agents of Vauxhall Motors Limited and are not authorised to bind Vauxhall Motors Limited by any specific or implied undertaking or representation. It is advisable to ensure that your motor insurance policy provides adequate cover for additional fitted options and accessories. The colours in this guide are only approximate actual colours. Illustrated optional equipment is available at extra charge. Availability, technical features and equipment provided on our vehicles can vary by model. For precise information on the equipment provided on our vehicles, please contact your local Vauxhall Retailer.