

CAR RANGE

PRICE GUIDE

4 June 2019 | Model Year 2019.5

MMY 2019



VAUXHALL

British Brand since 1903



VIVA

Price and Specification Guide | 1 April 2019 | Model Year 2019.5



VAUXHALL
British Brand since 1903



CONTENTS

RANGE HIGHLIGHTS

Explore the VIVA range and find your perfect model.

MODELS

Find all the information you need about your chosen model.

PRICES

Find on-the-road recommended retail prices.

FEATURES/OPTIONS

Tailor your chosen model to suit your needs with everything from satellite navigation to parking sensors.

EXTERIOR COLOURS

Add some sparkle to your car with a metallic paint.

PERFORMANCE, FUEL ECONOMY AND EMISSIONS

Know how many miles you will get around town, the CO₂ figures and the 0–60 time.

DIMENSIONS

Ensure your car will fit in the garage and know how much luggage you can take for a long weekend away.

SPECIFICATIONS

Towing weights, engine details and other useful details you may need to know.

ACCESSORIES

Add some practical touches to your car with our range of quality accessories.

COMPANY CAR INFORMATION

Benefit in Kind company car tax, 3 day test drives and P11D.

FURTHER INFORMATION

Insurance groups, vehicle excise duty, our range of additional products and much more.



VIVA RANGE HIGHLIGHTS



SE	OTR from £10,485	ROCKS	OTR from £12,245
<p>Standard features include:</p> <p>Safety:</p> <ul style="list-style-type: none">• Anti-lock Braking System (ABS)• Electronic Stability Programme (ESP)• Six airbags• ISOFIX child seat restraint system for outer rear seats• Perimeter alarm system <p>Interior features:</p> <ul style="list-style-type: none">• Power-assisted steering with City Mode• Electrically operated front windows• Electrically adjustable/heated door mirrors• Multi-function trip computer• Remote control central deadlocking• Stereo radio and USB audio connection• Bluetooth® connectivity• Steering wheel mounted audio controls• Tiltable steering column• Driver's seat height adjuster• 60/40 split-folding rear seat back and seat base <p>Exterior features:</p> <ul style="list-style-type: none">• Daytime running lights• Front fog lights• Emergency tyre inflation kit• 15-inch structure wheels		<p>Features over SE:</p> <p>Interior features:</p> <ul style="list-style-type: none">• Air conditioning <p>Exterior features:</p> <ul style="list-style-type: none">• Raised ground clearance• Anthracite rear bumper, side sills and wheel arch mouldings• Chrome-effect side sills and front and rear bumper inserts• Silver-effect roof rails• 15-inch bi-colour alloy wheels	

KEY OPTIONS	Total inc. VAT
Looking good:	
Brilliant paint	£285
Metallic / pearlescent paint	£565
Winter warming:	
Winter Pack	from £160
Driving assistance:	
Satellite Navigation systems	£985
Practicality:	
Rear parking distance sensors	£285
Full-size steel spare wheel	£110



SE



SE ON-THE-ROAD PRICES

		OTR RRP	CO ₂ (g/km)
Petrol	1.0i (73PS)	£10,485	117
	1.0i (73PS) (a/c)	£10,975	117

Please note: On-the-road recommended retail prices (RRP) include VAT at 20%, number plates and delivery to Retailer of £700.00 (inc. £116.67 VAT), 12 months' Vehicle Excise Duty and new vehicle first registration fee of £55.00. Excludes fuel and insurance.

a/c = Air conditioning.

FEATURES

Infotainment:

- R300 BT radio – for use with media players, USB memory sticks and mobile phones
- AM/FM stereo radio
- USB connection with iPod control
- Bluetooth® music streaming
- Bluetooth® mobile phone portal

Interior convenience / styling:

- Speed-sensitive power-assisted steering with City Mode
- Electrically operated front windows
- Electrically adjustable/heated door mirrors
- Multi-function trip computer
- Remote control central deadlocking
- Steering wheel mounted audio controls
- Tilttable steering column
- Driver's seat height adjuster
- Height-adjustable front seat head restraints
- 60/40 split-folding rear seat back and seat base
- Removable luggage compartment cover

Exterior features:

- Daytime running lights
- Front fog lights
- Emergency tyre inflation kit
- 15-inch structure wheels

Safety:

- Anti-lock Braking System (ABS)
- Electronic Stability Programme (ESP) with traction control
- Driver's and front passenger's airbags
- Front seat side-impact airbags
- Curtain airbags
- Tyre pressure monitoring system
- ISOFIX child seat restraint system for outer rear seats
- Three inertia-reel lap and diagonal rear seatbelts
- Perimeter alarm system
- Electronic engine deadlock immobiliser



ROCKS



ROCKS ON-THE-ROAD PRICES

		OTR RRP	CO ₂ (g/km)
Petrol	1.0i (73PS)	£12,245	118

Please note: On-the-road recommended retail prices (RRP) include VAT at 20%, number plates and delivery to Retailer of £700.00 (inc. £116.67 VAT), 12 months' Vehicle Excise Duty and new vehicle first registration fee of £55.00. Excludes fuel and insurance.

FEATURES

Infotainment:

- R300 BT radio – for use with media players, USB memory sticks and mobile phones
- AM/FM stereo radio
- USB connection with iPod control
- Bluetooth® music streaming
- Bluetooth® mobile phone portal

Interior convenience / styling:

- Air conditioning
- Cruise control
- Speed-sensitive power-assisted steering with City Mode
- Electrically operated front windows
- Electrically adjustable/heated door mirrors
- Multi-function trip computer
- Remote control central deadlocking
- Steering wheel mounted audio controls
- Tiltable steering column
- Driver's seat height adjuster
- Height-adjustable front seat head restraints
- 60/40 split-folding rear seat back and seat base
- Removable luggage compartment cover

Exterior features:

- Daytime running lights
- Front fog lights
- Raised ground clearance
- Anthracite rear bumper, side sills and wheel arch mouldings
- Chrome-effect side sills and front and rear bumper inserts
- Silver-effect roof rails
- Emergency tyre inflation kit
- 15-inch bi-colour alloy wheels

Safety:

- Anti-lock Braking System (ABS)
- Electronic Stability Programme (ESP) with traction control
- Driver's and front passenger's airbags
- Front seat side-impact airbags
- Curtain airbags
- Tyre pressure monitoring system
- ISOFIX child seat restraint system for outer rear seats
- Three inertia-reel lap and diagonal rear seatbelts
- Perimeter alarm system
- Electronic engine deadlock immobiliser



VIVA PRICES

	Fuel Type	Price (£)	VAT (£)	Total (£)	On-the-road RRP (£)	BiK 20% (£)	CO ₂ (g/km)
SE							
1.0i (73PS)	Petrol	7,966.67	1,593.33	9,560.00	10,485.00	46.17	117
1.0i (73PS) (a/c)	Petrol	8,375.00	1,675.00	10,050.00	10,975.00	48.37	117
ROCKS							
1.0i (73PS)	Petrol	9,433.33	1,886.67	11,320.00	12,245.00	54.08	118

Please note, VIVA model and option availability is restricted as factory orders can no longer be accepted. Please check with your Vauxhall Retailer.

a/c = Air conditioning.

Please note: On-the-road recommended retail prices (RRP) include number plates and delivery to retailer of £700.00 (inc. £116.67 VAT), 12 months' Vehicle Excise Duty and new vehicle first registration fee of £55.00. Excludes fuel and insurance. Company Car Benefit in Kind (BiK) rates are monthly based on the standard paint price.



FEATURES/OPTIONS

SAFETY

	SE	ROCKS	Price (£) exc. VAT	Price (£) inc. VAT
Driver / passenger airbags <ul style="list-style-type: none"> • Driver's airbag • Front passenger's airbag • Two front seat side-impact airbags • Full-size curtain airbags for driver and front and outer rear seat passengers 	●	●		
Seating <ul style="list-style-type: none"> • Height-adjustable front and rear seat head restraints • Anti-submarining ramps in all seats – Prevents occupants sliding underneath the lap belt during a collision. 	●	●		
Seatbelts <ul style="list-style-type: none"> • Front inertia-reel lap and diagonal seatbelts • Three inertia-reel lap and diagonal rear seatbelts • Front and rear seatbelt pretensioner system – Pretensioners tighten the seatbelt in the event of an accident limiting forward movement. • Front and rear 'seatbelt unfastened' audible warning and warning light 	●	●		
Child safety <ul style="list-style-type: none"> • Deactivation switch for front passenger seat's front airbag – Permits the safe use of a child seat in the front passenger seat. • ISOFIX child seat mountings incorporating top tether anchor points located on outer rear seats (does not include child seat) – Allows ISOFIX child safety seats to be securely fixed into the car. The ISOFIX mounting system reduces forward movement in an accident and makes the child seat easier to install. • Child-proof locks on rear doors 	●	●		
Pedestrian safety <ul style="list-style-type: none"> • Bonnet/headlight/wiper structure – Designed to reduce pedestrian head and upper body injuries. • Upper and lower bumper design – Reduces upper and lower leg injuries. 	●	●		



FEATURES/OPTIONS

SAFETY CONTINUED

	SE	ROCKS	Price (£) exc. VAT	Price (£) inc. VAT
<p>Stability</p> <ul style="list-style-type: none"> • Electronic Stability Programme (ESP) – Works in conjunction with the vehicle’s electronic braking and engine systems to keep the car stable in many different situations. ESP monitors many different inputs to determine when the car starts to lose traction, it can then immediately respond by varying the brake pressure between up to three wheels and adjust the engine output to help correct the loss of traction and improve stability. <p>Additional ESP features:</p> <ul style="list-style-type: none"> • Traction control • Cornering brake control • Straight line stability control • Rollover mitigation • Drag torque control – Maintain stability on slippery roads when lifting off the accelerator or changing gear. 	●	●		
<p>Braking</p> <ul style="list-style-type: none"> • Anti-lock Braking System (ABS) – Prevents the vehicle’s wheels from locking up under heavy braking by momentarily reducing brake pressure at the appropriate wheel, ensuring that you can maintain control of the steering. <p>Additional braking features:</p> <p>The same electronic systems used in the ABS and ESP also deliver exceptional braking performance.</p> <ul style="list-style-type: none"> • Emergency brake assist – When emergency braking is detected the vehicle automatically applies the maximum possible braking assistance. • Fading brake support – Compensates for the effects of brake fade. • Electronic brakeforce distribution – Automatically apportions the optimum braking force to each wheel. • Adaptive brake lights – Automatically warns other road users of heavy braking. • Hill start assist – Briefly maintains rear brake pressure to stop the vehicle rolling back on an incline. 	●	●		
<p>Tyre pressure</p> <ul style="list-style-type: none"> • Tyre pressure monitoring system 	●	●		



FEATURES/OPTIONS

SECURITY

	SE	ROCKS	Price (£) exc. VAT	Price (£) inc. VAT
Standard security features <ul style="list-style-type: none">• Electronically protected audio equipment• Engine deadlock immobiliser• Visible Vehicle Identification Number (VIN)• Locking fuel filler flap with interior release	●	●		
Perimeter alarm system <ul style="list-style-type: none">• Bonnet, doors, tailgate	●	●		
Remote control central locking <ul style="list-style-type: none">• Doors, tailgate• Interior activation switch on driver's door• Folding key	●	●		



FEATURES/OPTIONS

DRIVER ASSISTANCE

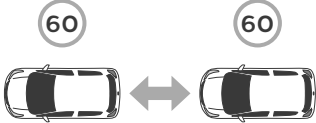
	SE	ROCKS	Price (£) exc. VAT	Price (£) inc. VAT
Power-assisted steering <ul style="list-style-type: none"> Electrically assisted steering Switchable 'City Mode' additional steering assistance <ul style="list-style-type: none"> – City Mode reduces steering effort for easy manoeuvring in city traffic and when parking. 	●	●		
Cruise control with speed limiter <ul style="list-style-type: none"> Cruise control – Set/keep a constant cruising speed without using the accelerator, ideal comfort for longer distance driving. Speed limiter function – Can be set to ensure that you do not exceed the speed limit. Steering wheel mounted controls 		●		
Shift-up/down indication light <p>Indicates when to change gear for optimum fuel economy.</p>	●	●		
Hill start assist <p>Briefly maintains rear brake pressure to stop the vehicle rolling back on an incline.</p>	●	●		
Rear parking distance sensors	○	○	237.50	285.00



FEATURES/OPTIONS

CONVENIENCE

	SE	ROCKS	Price (£) exc. VAT	Price (£) inc. VAT
Electrically operated front windows	●	●		
Twin electrically adjustable/heated door mirrors • Wide-angle mirror on driver's side • Automatic heater cut-off • Manual folding	●	●		



FEATURES/OPTIONS

DRIVER INFORMATION

	SE	ROCKS	Price (£) exc. VAT	Price (£) inc. VAT
Instrumentation • Speedometer • Rev counter • Digital fuel gauge with low fuel level warning light • Digital water temperature gauge with warning light	●	●		
Driver information display • Monochrome display • Displays trip computer data • Total mileage • Service-due indicator • Oil life • Tyre pressure monitoring system • Centrally located in instrument cluster	●	●		
Multi-function trip computer • Trip mileage • Vehicle range based on remaining fuel • Average speed • Average fuel economy • Instantaneous fuel economy • Driving time	●	●		
Multi-function central display (format dependent on infotainment unit) • Audio information • Digital clock with automatic RDS time adjustment • Outside air temperature	●	●		



FEATURES/OPTIONS

INTERIOR STYLING

	SE	ROCKS	Price (£) exc. VAT	Price (£) inc. VAT
SE interior décor Steering wheel: • Three-spoke design • Chrome-effect trim insert Facia and door trim: • Jet black facia • Jet black door panels • Black interior door handles Seat trim: • Bada Jet black fabric seat trim inserts • Plain black fabric side bolsters and surrounds	●			
Rocks interior décor Steering wheel: • Three-spoke design • Chrome-effect trim insert Facia and door trim: • Jet black facia • Jet black door panels • Chrome-effect interior door handles Seat trim: • Bada Jet black fabric seat trim inserts • Plain black fabric side bolsters and surrounds		●		
Additional décor features • Black gloss surround to outer facia air vents	●	●		
• Chrome-effect inserts to outer facia vents		●		
• Black gloss radio surround – Fitted in conjunction with optional Multimedia system or Navi 4.0 IntelliLink. Not available separately.	○	○		
• Black gloss instrument cluster and gear lever surround	●	●		
• Chrome-effect door sill covers		●		



FEATURES/OPTIONS

INFOTAINMENT

	SE	ROCKS	Price (£) exc. VAT	Price (£) inc. VAT
<p>R300 BT radio – for use with media players, USB memory sticks and mobile phones</p> <p>Onboard features:</p> <ul style="list-style-type: none"> • AM/FM stereo radio with 24 station presets • RDS with Traffic Programme • 25 watts per channel output <p>Media connections:</p> <ul style="list-style-type: none"> • USB connection with iPod control • Bluetooth® music streaming – Advanced Audio Distribution Profile (A2DP). <p>Mobile phone portal:</p> <ul style="list-style-type: none"> • Bluetooth® connectivity • Handsfree calls via steering wheel controls • Vehicle microphone • Phone book access – Features dependent on mobile phone. 	●	●		
<p>Navi 4.0 IntelliLink touchscreen navigation and infotainment system – for use with media players, USB memory sticks, mobile phones and smartphone apps</p> <p>Onboard features:</p> <ul style="list-style-type: none"> • 7-inch colour touchscreen • DAB digital radio/AM/FM stereo radio with 36 station presets • RDS with Traffic Programme <p>Navigation features:</p> <ul style="list-style-type: none"> • Satellite navigation system • 2D street level mapping • European coverage • Structured or one-box destination entry • Points-of-interest search • Eco routing • Map updates via USB <p>Media connections:</p> <ul style="list-style-type: none"> • USB connection with iPod control • Bluetooth® music streaming – Advanced Audio Distribution Profile (A2DP). <p>Mobile phone portal:</p> <ul style="list-style-type: none"> • Bluetooth® connectivity • Handsfree calls via steering wheel controls • Vehicle microphone • Phone book access – The majority of the phone's functions – contacts/last calls/missed calls etc. – are mirrored on display and are easily navigated using the touchscreen (features dependent on mobile phone). <p>Phone projection:</p> <ul style="list-style-type: none"> • Android Auto™ • Apple CarPlay™ incorporating Siri Eyes Free – Siri Eyes Free and Android Auto enable voice control of many functions of your smartphone: • Make/receive calls • Return missed calls • Listen to voicemail • Send/read out/reply to text messages • Access music library <p>Gallery:</p> <ul style="list-style-type: none"> • Only available when vehicle is stationary • Photo gallery with slide show feature • Video playback with soundtrack played through car speakers 	○	○	820.83	985.00
<p>Four speakers</p>	●	●		
<p>Steering wheel controls</p> <ul style="list-style-type: none"> • Audio controls • Bluetooth® mobile phone controls 	●	●		



FEATURES/OPTIONS

INTERIOR COMFORT

	SE	ROCKS	Price (£) exc. VAT	Price (£) inc. VAT
<p>Driver comfort</p> <p>Driver's seat (six-way adjustable):</p> <ul style="list-style-type: none"> • Reach (fore/aft) • Backrest recline (upright/incline) • Driver's seat height adjuster • Head restraint (up/down) <p>Steering adjustment:</p> <ul style="list-style-type: none"> • Steering column adjustable for rake 	●	●		
<p>Passenger comfort</p> <p>Front passenger's seat (six-way adjustable):</p> <ul style="list-style-type: none"> • Reach (fore/aft) • Backrest recline (upright/incline) • Head restraint (up/down) • Deactivation switch for front passenger seat's front airbag – Permits the safe use of a child seat in the front passenger seat. <p>Rear seat:</p> <ul style="list-style-type: none"> • Three person layout • 60/40 split-folding rear seat back and seat base • Three removable head restraints • ISOFIX child seat mountings incorporating top tether anchor points located on outer rear seats (does not include child seat) <ul style="list-style-type: none"> – Allows ISOFIX child safety seats to be securely fixed into the car. The ISOFIX mounting system reduces forward movement in an accident and makes the child seat easier to install. • Child-proof locks on rear doors 	●	●		



FEATURES/OPTIONS

HEATING AND VENTILATION

	SE	ROCKS	Price (£) exc. VAT	Price (£) inc. VAT
Air blend heater • Four-speed fan • Illuminated controls • Interior pollen filter	●			
Air conditioning • Air recirculation facility • Cabin particulate filter – Removes dust, airborne particles and pollen. • Four-speed fan • Illuminated controls	▲	●		
Additional features • Four adjustable facia vents • Windscreen demist vents • Side window demist vents	●	●		
SE Winter Pack • Electrically heated front seats • Electrically heated leather-covered steering wheel	○		191.67	230.00
ROCKS Winter Pack • Electrically heated front seats • Electrically heated leather-covered steering wheel		○	133.33	160.00



FEATURES/OPTIONS

INTERIOR CONVENIENCE, STORAGE AND LIGHTING

	SE	ROCKS	Price (£) exc. VAT	Price (£) inc. VAT
Convenience features <ul style="list-style-type: none"> • Front 12-volt electrical accessory socket • Twin sunvisors • Dipping rear-view mirror • Two roof-mounted rear coat hooks 	●	●		
<ul style="list-style-type: none"> • Front passenger's vanity mirror with flip-up cover and ticket holder 	●	●		
Interior storage <ul style="list-style-type: none"> • Glovebox with lid • Open storage above glovebox • Front door pockets • Two drinks holders in front centre console • Single drinks holder in rear passenger centre console 	●	●		
Load area <ul style="list-style-type: none"> • Luggage compartment cover • Fully carpeted load area • Interior tailgate handle • Twin gas-assisted tailgate struts • Touch-sensitive exterior tailgate release 	●	●		
Interior lighting <ul style="list-style-type: none"> • Instrument panel and facia light dimmer 	●	●		
<ul style="list-style-type: none"> • Front courtesy light 	●	●		



FEATURES/OPTIONS

EXTERIOR CONVENIENCE AND LIGHTING

	SE	ROCKS	Price (£) exc. VAT	Price (£) inc. VAT
Convenience features • Two-speed windscreen wipers with variable intermittent wipe • Heated rear window • Intermittent rear window wash/wipe • Manually foldable door mirrors	●	●		
Exterior lighting • Daytime running lights • Halogen headlights • Lights-on audible warning • Electric headlight beam levelling • High-level centre brake light • Rear fog light	●	●		
• Front fog lights		●		
• Front fog lights with cornering light function	●			





FEATURES/OPTIONS

EXTERIOR STYLING

	SE	ROCKS	Price (£) exc. VAT	Price (£) inc. VAT
SE body styling • Chrome-effect front grille bar • Body-colour door handles • Body-colour door mirrors • Body-colour rear roof spoiler	●			
Rocks body styling • Chrome-effect front grille bar • Body-colour door handles • Body-colour door mirrors • Body-colour rear roof spoiler • Raised ground clearance • Anthracite bumpers with chrome-effect inserts • Anthracite wheel arches • Anthracite side sills with chrome-effect inserts		●		
• Roof rails – silver-effect		●		
Windows • Tinted windows	●	●		



EXTERIOR COLOURS





			SE	ROCKS	Price (£) exc. VAT	Price (£) inc. VAT
Two-coat		Mushroom metallic	●	●		
Brilliant		Summit White	○	○	237.50	285.00
		Lava Red				

The colours reproduced may vary slightly from the actual paint colour. As a result they should be used as a guide only. Your Vauxhall Retailer has a comprehensive display of our paint samples.

● = Standard equipment. ○ = Optional at extra cost.

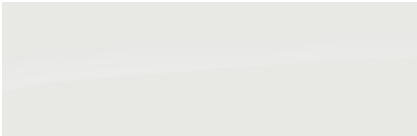

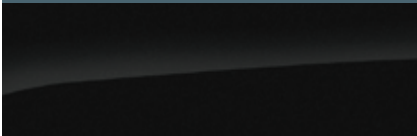
EXTERIOR COLOURS

			SE	ROCKS	Price (£) exc. VAT	Price (£) inc. VAT
Two-coat		Sovereign Silver metallic				
		Petrol Blue metallic				
		Quantum Grey metallic	O	O	470.83	565.00
		Mineral Black metallic				
Premium		Cherry Red	O	O	545.83	655.00

The colours reproduced may vary slightly from the actual paint colour. As a result they should be used as a guide only. Your Vauxhall Retailer has a comprehensive display of our paint samples.

O = Optional at extra cost.



WHEELS AND TYRES

	SE	ROCKS	Price (£) exc. VAT	Price (£) inc. VAT
 <p>15-inch structure wheels</p> <ul style="list-style-type: none">• 185/55 R 15 tyres• Emergency tyre inflation kit (in lieu of spare wheel)	●			
 <p>15-inch bi-colour alloy wheels</p> <ul style="list-style-type: none">• 185/55 R 15 tyres• Emergency tyre inflation kit (in lieu of spare wheel)		●		
Full-size steel spare wheel (in lieu of emergency tyre inflation kit)	○	○	91.67	110.00



PERFORMANCE, FUEL ECONOMY AND EMISSIONS

	Performance (manufacturer's figures)				Fuel economy mpg (litres/100km)#		CO ₂ emissions g/km*	Vehicle Excise Duty**		Benefit in kind company car taxation rates - 2018/19 tax year
	Fuel Type	Wheel size (inches)	Maximum speed (mph)	Acceleration 0-60mph (sec)	Combined Low	Combined High		First year rate	Standard rate	
VIVA										
1.0i (73PS)	Petrol	15	106	13.1	45.6 (6.2)	46.3 (6.1)	117	£170	£145	27%
1.0i (73PS) ROCKS	Petrol	15	106	13.1	45.6 (6.2)	46.3 (6.1)	118	£170	£145	27%

#Fuel consumption figures are determined according to the WLTP test cycle. Full data relating to WLTP test cycles can be found at: www.vauxhall.co.uk/wltp

*CO₂ emissions figures are determined according to the WLTP test cycle however, a Government formula is then applied to translate these figures back to what they would have been under the outgoing NEDC test cycle, which WLTP replaces. The correct tax treatment is then applied.

Figures are intended for comparability purposes only. The fuel consumption you achieve under real life driving conditions and CO₂ produced will depend upon a number of factors, including the accessories fitted after registration, variations in driving styles, weather conditions and vehicle load. Only compare fuel consumption and CO₂ with other vehicles tested using the same technical procedures. For more information contact your local Vauxhall Retailer.

**Correct at time of publication.



DIMENSIONS

VIVA

Loadspace Dimensions millimetres (inches)

Load floor length (rear seats folded)	1107 (43.6)
Load floor length (behind rear seats)	484 (19.1)
Load area width	960 (37.8)
Load area height	850 (33.5)
Tailgate aperture width (maximum)	955 (37.6)
Tailgate aperture height	608 (23.9)

Luggage Capacities* litres (cu.ft.)

Rear seat up**	206 (7.3)
Rear seat down†	1013 (35.8)

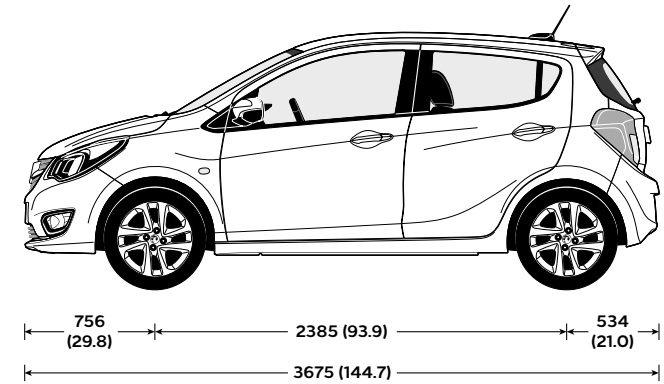
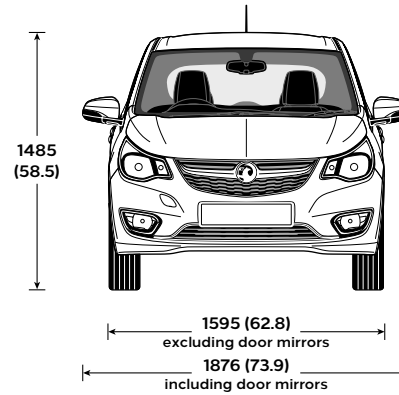

VIVA

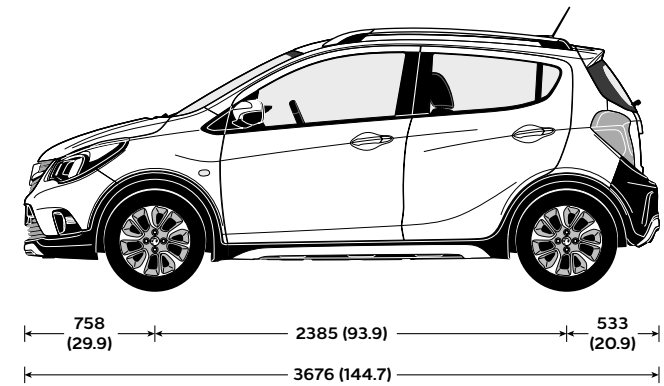
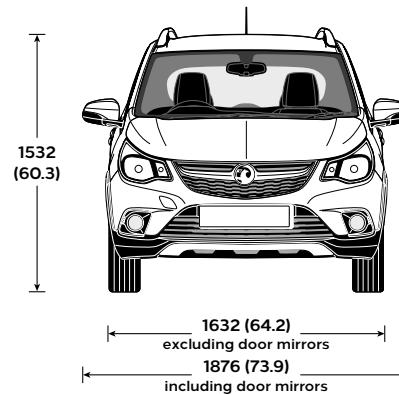

VIVA ROCKS

All measurements are in mm (inches) unless stated otherwise.

*Measured using the ECIE method.

**Under luggage compartment cover.

†Measured to roof.



SPECIFICATIONS

Transmission

- Front-wheel drive
- Five-speed manual gearbox

Steering

- Speed-sensitive electric power-assisted system
- Switchable City Mode for additional assistance
- Energy-absorbing steering column
- Turning circle (kerb-to-kerb): 10.4m (34.1ft.)

Suspension

Front: Independent. MacPherson struts with gas-pressure dampers and linear-rate coil springs. Anti-roll bar.

Rear: Torsion beam with gas-pressure dampers and linear-rate coil springs.

Brakes

- Anti-lock Braking System (ABS) – Four-channel
- Electronic brakeforce distribution
- Electronic Stability Programme
- Switchable traction control
- Dual circuit, diagonally split, servo-assisted system
- Asbestos-free friction material
- Corrosion-protected brake pipes

All models

- Front ventilated discs: 236mm diameter
- Rear drums: 200mm diameter

Body

- Aerodynamic drag co-efficient: Cd 0.331

Fuel Tank Capacity

- 32 litres (7.0 gallons)

Electrics

- Battery: 50Ah
- Alternator: 80A

Weights kg

	Gross Vehicle Weight (GVW)
1.0i (73PS)	1353

Gross vehicle weight is the total permissible weight of the vehicle including passengers and their luggage. Rocks models are the only VIVA models approved for carrying a roof load. The roof load should not exceed 50kg including the weight of the roof rack/carrier.



PETROL ENGINE

Engine	1.0i (73PS)
Capacity	999cc
Maximum power	73PS (54kW) @ 6500rpm
Maximum torque	95Nm (70 lb.ft.) @ 4500rpm
Configuration	3 cylinders, 4 valves per cylinder, double overhead camshafts
Fuel/induction system	Naturally aspirated with Variable Valve Timing. Multi-point sequential electronic fuel injection
Emission compliance	Euro 6d-TEMP (6.2)
Service interval	20,000 miles or 1 year (whichever occurs sooner)



ACCESSORIES

CHILD SEATS ¹	Total (inc. VAT)	PRACTICAL	Total (inc. VAT)	STYLING	Total (inc. VAT)
BABY-SAFE ² – 0–13kg/birth to 15 months	£141	Spare bulb kit	£41	VX-Line stainless steel pedal covers	£67
– ISOFIX base	£244	Smoker Pack	£38	Door sill plates	£56
DUO ISOFIX ² – 9–18kg/9 months to 4 years		Centre console organiser	£17		
with top tether kit	£372				
KID ² –15–36kg or 4 to 12 years	£168				
		PROTECTION		WHEELS³	
SAFETY		Velour floor mats – set of four	£66	15-inch 8-spoke alloy wheel	£716
Privacy shades – rear side windows	£64	Carpet floor mats – set of four	£43	16-inch 4 double-spoke alloy wheel	£754
Privacy shades – tailgate window	£64	Cargo liner	£59		
Parking sensors		Load area storage box	£99		
– four fully flush front bumper mounted		Load area retaining net	£84		
sensors		Splash Guards			
– unpainted	£349	– Front	£66		
– painted	£349	– Rear	£66		
– four fully flush rear bumper mounted		Body side mouldings	£164		
sensors					
– unpainted	£349				
– painted	£349				
Safety Pack – first aid kit, hi-visibility vest					
and small warning triangle	£30				
Warning triangle – Small	£12				
Warning triangle – Large	£20				
First aid kit	£15				
Hi-visibility vest	£9				
Tyre sealant	£68				
Tyre inflation compressor	£266				
FLEXCONNECT RANGE					
FlexConnect bracket	£22				
FlexConnect hook	£32				
FlexConnect coat hanger	£34				
FlexConnect folding table	£77				
FlexConnect iPad Mini cradle	£109				
FlexConnect iPad (1-4) cradle	£118				
FlexConnect iPad Air cradle	£117				
FlexConnect Samsung Galaxy cradle	£107				

Please note: Prices shown are fully fitted and painted, where applicable and include VAT. Please check with your local Vauxhall Retailer for details. It is advisable to ensure your insurance policy is adequate to cover additional fitted accessories. Prices correct at time of publication.

1 = Restrictions apply to the use of child seats, please consult your Vauxhall Retailer or request a copy of the Child seats brochure. 2 = Without transponder. 3 = Fitting time is based on four wheels fitted and includes static wheel balancing. Different tyres and locking wheel nuts may be required. Price excludes new tyres and locking wheel nuts.



COMPANY CAR DRIVER AND FLEET INFORMATION

Company Car Driver Free 3 Day Test Drive

Our free* 3 Day Test Drive programme is open to all Company Car Drivers which allows you to choose any model in the current Vauxhall line-up (exclusions apply). With full insurance cover provided, it gives you a meaningful length of time to make an informed decision about your next company car.

Search Vauxhall 3DTD to book your FREE* test drive or click the link the below:

[Vauxhall 3 Day Test Drive](#)

*The free 3 Day Test Drive programme is open to Company Car Drivers and Fleet Decision Makers. Available for UK Mainland only. Terms and conditions apply. Full terms and conditions can be found at vauxhallfleet.co.uk/testdrive/index/terms.

Fleet Toolbox

Discover the facts in our online Toolbox for both Company Car Drivers and Fleet Decision Makers. The Fleet Toolbox has a host of useful calculators, comparators, interactive listings and information.

Search Vauxhall Fleet Tools or click the link below:

[Vauxhall Fleet Tool Box](#)

Benefit in kind company car taxation†

The car benefit charge will be the car's list price (including VAT, options and accessories fitted, delivery to Retailer and number plates, but excluding Vehicle Excise Duty and new vehicle first registration fee) multiplied by the percentage charge for the CO₂ emissions band in which the car falls (see table opposite). Multiply this figure by your personal income tax rate (20%†† for Basic Rate, 40%†† for Higher Rate) to calculate your annual benefit in kind tax liability.

Example:

VIVA SE 1.0i (73PS) (CO₂ emissions 117g/km)

On-the-road RRP	£10,485.00
Deduct: Vehicle Excise Duty	(£170.00)
New vehicle first registration fee	(£55.00)
Effective list price	£10,260.00
Add: Optional two-coat metallic paint	£565.00
List price for tax purposes (P11D value)	£10,825.00
Car benefit charge 2019-20 tax year (27%)	£2,923.00
Benefit in kind tax liability (2019-20 tax year)	
Basic Rate (20%) tax payer	£584.60
Higher Rate (40%) tax payer	£1,169.20

†Please note this Price Guide provides taxation information as a guide only. Vauxhall does not provide taxation guidance. Drivers should always take professional advice on their own tax position. ††Excludes residents of Scotland.

BIK FOR SCOTTISH RESIDENTS

Effective 6 April 2018 the Scottish Government have introduced their own BIK taxation structure. This only applies to Company Car Drivers that are Scottish taxpayers. HMRC will determine whether or not an individual is a Scottish taxpayer based on where their main place of residence is.

The BIK rates for Scotland are:

- Over £12,500-£14,549 Starter Rate 19%
- Over £14,549-£24,994 Basic Rate 20%
- Over £24,994-£43,430 Intermediate Rate 21%
- Over £43,430-£150,000 Higher Rate 41%
- Above £150,000 Top Rate 46%

Benefit in kind company car taxation table

CO ₂ emissions in grams per kilometre	Percentage of cars price to be taxed	
	Non-Diesel† 2019-20 tax year	Diesel†† 2019-20 tax year
Up to 50	16	20
51-75	19	23
76-94	22	26
95-99	23	27
100-104	24	28
105-109	25	29
110-114	26	30
115-119	27	31
120-124	28	32
125-129	29	33
130-134	30	34
135-139	31	35
140-144	32	36
145-149	33	37
150-154	34	37
155-159	35	37
160-164	36	37
165-169	37	37
170-174	37	37
175-179	37	37
180 and above	37	37

†Also applies to diesel vehicles that meet the Real Driving Emissions Step 2 (RDE2). ††Applies to vehicles that do not meet the Real Driving Emissions Step 2 (RDE2).

To calculate your own personal liability, search:

Vauxhall BiK, or click the link below:

[Vauxhall BiK Tool](#)

Contact Vauxhall Fleet

Please contact one of our dedicated sales teams who will be happy to help with your particular enquiry.

Company Car Drivers

Call: 0345 111 2020

Email: company-car@vauxhallinfo.co.uk

Telephone lines are open

- Monday to Friday 8:00am-9:00pm

- Saturday and Sunday 9:00am-6:00pm

Fleet Decision Makers

Depending on the size of your fleet of vehicles, we have a dedicated team to handle your enquiries.

The lines are open Monday to Friday excluding Bank Holidays.

1-24 vehicles

Call: 0845 076 2254 (8:30am-5:00pm)

25+ vehicles

Call: 0330 587 8222 (8:30am-5:00pm)

Email: vauxhallfleet@vauxhall.co.uk

Special Vehicles (Police, Fire and Ambulance)

Call: 01582 409999 (8:30am-5:00pm)

Email: vauxhallspecialvehicles@vauxhall.co.uk



FURTHER INFORMATION

On-the-road prices

To eliminate uncertainty about hidden costs when buying a new car, Vauxhall publishes on-the-road recommended retail prices (RRP) and these are shown in the pricing tables within this price guide. These prices include VAT, number plates and delivery to Retailer of £700.00 (including £116.67 VAT), 12 months' Government Vehicle Excise Duty (see opposite for details) and the DVLA new vehicle first registration fee of £55.00.*

Please note: The on-the-road recommended retail price (RRP) does not include fuel supplied by the Retailer, motor insurance or any other goods or services supplied by agreement between the Retailer and the customer.

Price protection

Order a new Vauxhall for build in the current model year (as confirmed by your Retailer) for delivery no more than three months in advance and the price you are quoted is the price you pay. This is irrespective of any subsequent price rises between placing your order and delivery of your new car, but you must take delivery as soon as the car is available. Vauxhall Motors Limited is not liable for price adjustments caused by Government changes in the rate of VAT (currently 20%), Vehicle Excise Duty, DVLA new vehicle first registration fee or by any other applicable legislation or regulations.

Vauxhall Finance Leasing

Vauxhall Finance Leasing is a trading style of Vauxhall Finance plc. Working with the Vauxhall Retailer network we provide competitive car and van leasing solutions for business users and private individuals. We combine the support of a national contract with the convenience of a local contact. For further information, please contact your local Vauxhall Retailer or visit www.vauxhall.co.uk/leasing

In the event of an accident

Vauxhall Accident Management helps keep you mobile following an accident. Benefits include vehicle recovery, Vauxhall-approved repairs and contacting your insurer. For more details, visit www.vauxhall.co.uk/AccidentManagement

Vehicle Excise Duty

The amount of Vehicle Excise Duty (road fund licence) payable on new cars varies depending on the level of carbon dioxide (CO₂) emissions produced by the vehicle. CO₂ emissions are measured in grams per kilometre (g/km) travelled and divided into 13 charging bands shown in the table opposite.

A 'first year rate' of Vehicle Excise Duty is payable on all new cars and in subsequent years the amount payable reverts to the 'standard rate'. From 1 April 2017 the breakpoints for each of these bands have been revised. Also, for vehicles with a list price over £40,000, including factory-fitted options, an additional £320 is payable for the first five years of standard rate payments.

Vehicle Excise Duty*

Band	CO ₂ emissions in grams per kilometre	First year rate		
		Petrol [#]	Diesel [†]	Standard rate
A	0	£0	£0	£0
B	1-50	£10	£25	£145
C	51-75	£25	£110	£145
D	76-90	£110	£130	£145
E	91-100	£130	£150	£145
F	101-110	£150	£170	£145
G	111-130	£170	£210	£145
H	131-150	£210	£530	£145
I	151-170	£530	£855	£145
J	171-190	£855	£1,280	£145
K	191-225	£1,280	£1,815	£145
L	226-255	£1,815	£2,135	£145
M	over 255	£2,135	£2,135	£145

Insurance Groups

	SE	SE (a/c)	ROCKS
1.0 (73PS)	4E	5E	5E

Tyre Rating

Tyre size	Fuel efficiency group	Wet grip performance	External noise	
			Measured (dB)	Group
185/55 R 15	B-C	B	71	

According to EU Regulation 1222/2009

*Correct at time of issue.

[#]Also applies to diesel vehicles that meet the Real Driving Emissions Step 2 (RDE2).

[†]Applies to vehicles that do not meet the Real Driving Emissions Step 2 (RDE2).



FURTHER INFORMATION

Customer Care Commitment

For added peace of mind, Vauxhall has an innovative Customer Care Commitment that offers the following:

- Three-year vehicle warranty consisting of a one-year/unlimited mileage manufacturer's warranty and a second and third year manufacturer's warranty with a 60,000 miles limitation
- Vauxhall Assistance for 12 months from first registration
- Six years' body panel anti-perforation warranty

Please note: Warranty is only available on vehicles sourced from Vauxhall Motors Limited. Terms and conditions apply. Please see your Vauxhall Retailer for details.

Vauxhall Assistance

Vauxhall Assistance is provided automatically with every new Vauxhall for 12 months from first registration and covers everything from accident assistance, roadside recovery and 'at home' service to flat tyres. With Vauxhall Assistance help is literally just a free* phone call away, 24 hours a day, 365 days a year!

*Mobile phone users will be charged at their standard tariff.

Protecting the environment

Vauxhall's commitment to the environment is demonstrated by our products' many environmental awards. For even more information on Vauxhall's efforts to achieve an environmentally sustainable future, and how to dispose of your end-of-life vehicle, see www.vauxhall.co.uk/recycling

Vauxhall Service Plan

- Fixed monthly payments for the plan duration
- Easy to budget and interest-free
- Genuine parts fitted by Vauxhall-trained technicians
- Plus on Gold plans:
 - Valet and courtesy car
 - Vauxhall Roadside Assistance
 - Engine flush and fuel treatments
 - Litre of oil for top ups between services

Full details can be obtained from your local participating Vauxhall Retailer.

Vauxhall Insurance with added reassurance

Comprehensive cover – Summary of benefits**

- Competitive premiums
- Repairs by a Vauxhall-trained technician
- Genuine Vauxhall parts, guaranteed for three years when we repair your car within our Approved Repairer Network
- Free courtesy car as standard when using an Approved Repairer†
- 24 hour claims helpline
- Personal Accident benefit
- Cover for audio equipment
- Windscreen cover

Call for a quote on **0844 463 2670**††

**The benefits listed above are for comprehensive cover only. For details of Third Party, Fire and Theft cover, please call our sales team.

†Should your car need repairing following an accident we provide a courtesy car (subject to availability) for the duration of the repair. Only genuine Vauxhall parts are used. Terms and conditions apply.

††Calls may be recorded. Vauxhall Insurance is underwritten by Ageas Insurance Limited.

For more product information

For further information on the Vauxhall range or location of your nearest Vauxhall Retailer please call **0345 600 1500**. Alternatively, details can be found on our website at www.vauxhall.co.uk

Join us online



Privacy Policy – for full details visit www.vauxhall.co.uk/privacy

The invoice price, including delivery to Retailer, factory-fitted options, accessories fitted by the Retailer and number plates, is subject to VAT. Some feature descriptions in this guide may refer to, and some illustrations may show, optional equipment not included in the standard delivery. The information contained in this guide was accurate at the time of publication. We reserve the right to make changes in design and equipment. Please note that Vauxhall Retailers are not the agents of Vauxhall Motors Limited and are not authorised to bind Vauxhall Motors Limited by any specific or implied undertaking or representation. It is advisable to ensure that your motor insurance policy provides adequate cover for additional fitted options and accessories. The colours in this guide are only approximate actual colours. Illustrated optional equipment is available at extra charge. Availability, technical features and equipment provided on our vehicles can vary by model. For precise information on the equipment provided on our vehicles, please contact your local Vauxhall Retailer.

VAUXHALL

vauxhall.co.uk

©2019 Vauxhall Motors Limited

Published 1 April 2019 (Amended 17 May 2019) Vauxhall Motors Limited, Luton LU4 9TT

ADAM

PRICE/SPECIFICATION GUIDE

1 April 2019 | Model Year 2019.5



VAUXHALL

British Brand since 1903

ADAM RANGE HIGHLIGHTS



JAM OTR from £13,855

Standard features include:

Infotainment:

- CD 30 BT audio system
 - AM/FM radio
 - CD/MP3 CD player
 - Bluetooth® audio streaming
 - Bluetooth® mobile phone portal
 - USB audio connection
 - Aux-in socket

Interior convenience / styling:

- Air conditioning
- Cruise control
- Leather-covered steering wheel
- Steering wheel audio / phone / cruise controls
- Multi-function trip computer

Exterior convenience / styling:

- 16-inch alloy wheels
- Electrically operated front windows
- Electrically adjustable / heated door mirrors

Safety / security features:

- Electronic Stability Programme (ESP)
- Anti-lock Braking System (ABS)
- Tyre pressure monitoring system
- Six airbags
- Daytime running lights
- Remote control central deadlocking

Please note, ADAM model and option availability is restricted as factory orders can no longer be accepted. Please check with your Vauxhall Retailer.



ENERGISED OTR £15,705

Standard features include:

Infotainment:

- IntelliLink audio system
 - 7-inch colour touchscreen
 - AM/FM/DAB digital radio
 - Bluetooth® audio streaming
 - Bluetooth® mobile phone portal
 - Apple CarPlay™ / Android Auto™
 - USB audio connection

Interior convenience / styling:

- Air conditioning
- Cruise control
- Leather-covered steering wheel
- Steering wheel audio / phone / cruise controls
- Multi-function trip computer

Exterior convenience / styling:

- 17-inch black alloy wheels
- Black Jack roof and door mirrors
- Gloss black front grille bar
- Range of brilliant, metallic and premium colours available at no additional cost
- Sports suspension
- Electrically operated front windows
- Electrically adjustable / heated door mirrors

Safety / security features:

- Electronic Stability Programme (ESP)
- Anti-lock Braking System (ABS)
- Tyre pressure monitoring system
- Six airbags
- Daytime running lights
- Remote control central deadlocking

Please note, ADAM model and option availability is restricted as factory orders can no longer be accepted. Please check with your Vauxhall Retailer.



GRIFFIN PRICE AVAILABLE ON REQUEST FROM RETAILER

Standard features include:

Infotainment:

- Navi 4.0 IntelliLink satellite navigation system
 - Fully integrated European satellite navigation system
 - 7-inch colour touchscreen
 - AM/FM/DAB digital radio
 - Bluetooth® audio streaming
 - Bluetooth® mobile phone portal
 - Apple CarPlay™ / Android Auto™
 - USB audio connection

Interior convenience / styling:

- Air conditioning
- Cruise control
- Leather-covered steering wheel
- Steering wheel audio / phone / cruise controls
- Multi-function trip computer
- Front and rear floor mats (front Griffin-branded)

Exterior convenience / styling:

- 17-inch black alloy wheels
- Black Jack roof and door mirrors
- Gloss black front grille bar
- Range of brilliant, metallic and premium colours available at no additional cost
- Sports suspension
- Electrically operated front windows
- Electrically adjustable / heated door mirrors

Safety / security features:

- Electronic Stability Programme (ESP)
- Anti-lock Braking System (ABS)
- Tyre pressure monitoring system
- Six airbags
- Daytime running lights
- Remote control central deadlocking

Colours and model variants for Griffin special edition subject to availability. Please check with your Vauxhall Retailer.



ADAM JAM





3-door hatchback
OTR RRP CO₂ (g/km)

ADAM JAM – ON-THE-ROAD PRICES

Petrol 1.2i (70PS) £13,855 128

Please note: On-the-road recommended retail prices (RRP) include VAT at 20%, number plates and delivery to Retailer of £700.00 (inc. £116.67 VAT), 12 months' Vehicle Excise Duty and new vehicle first registration fee of £55.00. Excludes fuel and insurance.

Please note, ADAM model and option availability is restricted as factory orders can no longer be accepted. Please check with your Vauxhall Retailer.

KEY OPTIONS		Total inc. VAT
 Looking good:	Brilliant paint	£285
	Metallic paint	£565
	Premium paint	£655
	Style Pack – Black Jack or White my Fire Roof Colour Pack / 17-inch alloy wheels / dark-tinted rear windows	£705
 Easier parking:	Rear parking sensors	£285
 Driving assistance:	Navi 4.0 IntelliLink navigation system	£785
	Sight and Light Pack One – Automatic lights / wipers / anti-dazzle rear-view mirror	£240
 Warm welcome:	Winter Pack – Heated front seats / steering wheel	£225
	 Practicality:	Steel emergency spare wheel (in lieu of emergency tyre inflation kit)

For details of these and other options please see Features / Options pages.



FEATURES

Infotainment:

- CD 30 BT audio system
 - AM/FM radio
 - CD/MP3 CD player
 - Bluetooth® audio streaming
 - Bluetooth® mobile phone portal
 - USB audio connection
 - Aux-in socket
- Four speakers

Interior convenience / styling:

- Cruise control
- Air conditioning
- Leather-covered steering wheel
- Speed-sensitive power-assisted steering
- City mode button
- Steering column adjustable for reach / rake
- Steering wheel audio / phone / cruise controls
- Driver's seat height adjuster
- Multi-function trip computer
- 50/50 split-folding rear seat back





Exterior convenience / styling:

- Electrically operated front windows
- Electrically adjustable / heated door mirrors
- Body-colour door handles
- Black B-pillars
- 16-inch alloy wheels

Safety / security features:

- Electronic Stability Programme (ESP)
- Anti-lock Braking System (ABS)
- Six airbags
- Hill start assist
- Seatbelt reminders for all seats
- ISOFIX child seat mounting points on rear seats
- Tyre pressure monitoring system
- Daytime running lights
- Remote control central locking
- Engine deadlock immobiliser

COMPANY CAR INFORMATION

-  P11D price starting at £13,630
-  From 29% tax band*
-  From £66 monthly BiK tax*
-  CO₂ emissions from 128g/km

Please see www.vauxhall.co.uk/fleet for details.

* = 2019/20 tax year.

ADAM ENERGISED

3-door hatchback
OTR RRP CO₂ (g/km)

ADAM ENERGISED – ON-THE-ROAD PRICES

Petrol 1.2i (70PS)	£15,705	128
--------------------	---------	-----

Please note: On-the-road recommended retail prices (RRP) include VAT at 20%, number plates and delivery to Retailer of £700.00 (inc. £116.67 VAT), 12 months' Vehicle Excise Duty and new vehicle first registration fee of £55.00. Excludes fuel and insurance.

Please note, ADAM model and option availability is restricted as factory orders can no longer be accepted. Please check with your Vauxhall Retailer.

KEY OPTIONS		Total inc. VAT
 Looking good:	Brilliant paint	No-cost
	Metallic paint	No-cost
	Premium paint	No-cost
	Dark-tinted rear windows	£175

For details of these and other options please see Features / Options pages.



FEATURES

Infotainment:

- IntelliLink audio system
 - 7-inch colour touchscreen
 - AM/FM/DAB digital radio
 - Bluetooth® audio streaming
 - Bluetooth® mobile phone portal
 - Apple CarPlay™ / Android Auto™
 - USB audio connection
- Four speakers

Interior convenience / styling:

- Air conditioning
- Leather-covered steering wheel
- Cruise control
- Speed-sensitive power-assisted steering
- City mode button
- Steering column adjustable for reach / rake
- Steering wheel audio / phone / cruise controls
- Driver's seat height adjuster
- Multi-function trip computer
- 50/50 split-folding rear seat





Exterior convenience / styling:

- Black Jack roof and door mirrors
- Gloss black front grille bar
- Range of brilliant, metallic and premium colours available at no additional cost
- Electrically operated front windows
- Electrically adjustable / heated door mirrors
- Sports suspension
- 17-inch black alloy wheels

Safety / security features:

- Electronic Stability Programme (ESP)
- Anti-lock Braking System (ABS)
- Six airbags
- Hill start assist
- Seatbelt reminders for all seats
- ISOFIX child seat mounting points on rear seats
- Tyre pressure monitoring system
- Daytime running lights
- Remote control central locking

COMPANY CAR INFORMATION

-  P11D price starting at £15,480
-  From 29% tax band*
-  From £75 monthly BiK tax*
-  CO₂ emissions from 128g/km

Please see www.vauxhall.co.uk/fleet for details.

* = 2019/20 tax year.

ADAM GRIFFIN

3-door hatchback
CO₂ (g/km)

ADAM GRIFFIN – PRICE AVAILABLE ON REQUEST FROM RETAILER

Petrol 1.2i (70PS) 128

Please note: On-the-road recommended retail prices (RRP) include VAT at 20%, number plates and delivery to Retailer of £700.00 (inc. £116.67 VAT), 12 months' Vehicle Excise Duty and new vehicle first registration fee of £55.00. Excludes fuel and insurance.

Colours and model variants for Griffin special edition subject to availability. Please check with your Vauxhall Retailer.



FEATURES

Infotainment:

- Navi 4.0 IntelliLink satellite navigation system
 - Fully integrated European satellite navigation system
 - 7-inch colour touchscreen
 - AM/FM/DAB digital radio
 - Bluetooth® audio streaming
 - Bluetooth® mobile phone portal
 - Apple CarPlay™ / Android Auto™
 - USB audio connection
- Four speakers

Interior convenience / styling:

- Air conditioning
- Leather-covered steering wheel
- Cruise control
- Speed-sensitive power-assisted steering
- City mode button
- Steering column adjustable for reach / rake
- Steering wheel audio / phone / cruise controls
- Driver's seat height adjuster
- Multi-function trip computer
- 50/50 split-folding rear seat
- Front and rear floor mats (front Griffin-branded)

Exterior convenience / styling:

- Black Jack roof and door mirrors
- Gloss black front grille bar
- Range of brilliant, metallic and premium colours available at no additional cost
- Electrically operated front windows
- Electrically adjustable / heated door mirrors
- Sports suspension
- 17-inch black alloy wheels

Safety / security features:

- Electronic Stability Programme (ESP)
- Anti-lock Braking System (ABS)
- Six airbags
- Hill start assist
- Seatbelt reminders for all seats
- ISOFIX child seat mounting points on rear seats
- Tyre pressure monitoring system
- Daytime running lights
- Remote control central locking



COMPANY CAR INFORMATION

- ✓ P11D price starting at £14,190
- ✓ From 29% tax band*
- ✓ From £69 monthly BiK tax*
- ✓ CO₂ emissions from 128g/km

Please see www.vauxhall.co.uk/fleet for details.

* = 2019/20 tax year.

ADAM PRICES

Model 3-door hatchback	Price (£)	VAT (£)	Total (£)	On-the-road RRP (£)	BiK 20% (£)	CO ₂ (g/km)
ADAM JAM						
1.2i (70PS)	10775.00	2155.00	12930.00	13855.00	65.87	128
ADAM ENERGISED (SPECIAL EDITION MODEL)						
1.2i (70PS)	12316.67	2463.33	14780.00	15705.00	74.82	128
ADAM GRIFFIN (SPECIAL EDITION MODEL)						
1.2i (70PS)	PRICE AVAILABLE ON REQUEST FROM RETAILER					128

Please note: On-the-road recommended retail prices (RRP) include number plates and delivery to Retailer of £700.00 (inc. £116.67 VAT), 12 months' Vehicle Excise Duty and new vehicle first registration fee of £55.00. Excludes fuel and insurance. Company Car Benefit in Kind (BiK) rates are monthly based on the standard paint price.

Colours and model variants for Griffin special edition subject to availability. Please check with your Vauxhall Retailer.

Please note, ADAM model and option availability is restricted as factory orders can no longer be accepted. Please check with your Vauxhall Retailer.

ADAM FEATURES / OPTIONS

SAFETY

Driver/passenger airbags

- Driver's airbag • Front passenger's airbag • Front seat side-impact airbags
- Full-size curtain airbags for front and rear seat passengers

Seating

- Height-adjustable front seat head restraints • Outer rear seat head restraints
- Anti-submarining ramps in front seats – Helps prevent occupants sliding underneath the lap belt during a collision.

Seatbelts

- Height-adjustable front seatbelts • Four inertia-reel lap and diagonal seatbelts • Front seatbelt pretensioner system – Pretensioners tighten the seatbelt in the event of an accident limiting forward movement. • Front seatbelt force limiters – Reduces potential upper body injuries during a frontal impact. • Front and rear 'seatbelt unfastened' warning light

Child safety

- Deactivation switch for front passenger's front and side-impact airbags – Permits the safe use of a child seat in the front passenger seat. • ISOFIX child seat mountings incorporating top tether anchor points located on rear seats (does not include child seat) – Allows ISOFIX child safety seats to be securely fixed into the car. The ISOFIX mounting system reduces forward movement in an accident and makes the child seat easier to install.

Driver/passenger safety

- Energy-absorbing steering column • Pedal release system – Reduces potential injury to the driver's legs and feet during a severe frontal impact. • Laminated windscreen • Side-impact protection beams • Reinforced passenger safety cell • Deformation zones front and rear

Pedestrian safety

- Bonnet/headlight/wiper structure – Designed to reduce pedestrian head and upper body injuries.
- Upper and lower bumper design – Reduces upper and lower leg injuries.

Stability

Electronic Stability Programme (ESP):

– Works in conjunction with the vehicle's electronic braking and engine systems to keep the car stable in many different situations. ESP monitors many different inputs to determine when the car starts to lose traction, it can then immediately respond by varying the brake pressure between up to three wheels and adjust the engine output to help correct the loss of traction and improve stability.

Additional ESP features:

- Traction control • Cornering brake control
- Straight line stability control

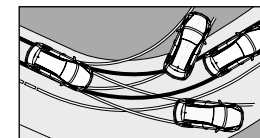

Braking

Anti-lock Braking System (ABS):

– Prevents the vehicle's wheels from locking up under heavy braking by momentarily reducing brake pressure at the appropriate wheel, ensuring that you can maintain control of the steering.

Additional braking features:

– The same electronic systems used in the ABS and ESP also deliver exceptional braking performance.

- Emergency brake assist – When emergency braking is detected the vehicle automatically applies the maximum possible braking assistance.
- Electronic brakeforce distribution – Automatically apportions the optimum braking force to each wheel. • Adaptive brake lights – Automatically warns other road users of heavy braking. • Hill start assist – Briefly maintains rear brake pressure to stop the vehicle rolling back on an incline. • Hazard warning lights

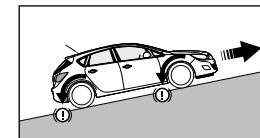

Tyre pressure

- Tyre pressure monitoring system

ADAM FEATURES / OPTIONS

	JAM	ENERGISED	GRIFFIN	Price (£) exc. VAT	Total (£) inc. VAT
DRIVER ASSISTANCE					
Cruise control with speed limiter <i>Cruise control feature – enables you to maintain a constant speed – making it ideal for economical motorway driving.</i> <ul style="list-style-type: none"> The speed limiter function – can be set to ensure that you do not exceed the speed limit and can be easily overridden if required. Steering wheel mounted controls 	●	●	●		
Parking sensors <ul style="list-style-type: none"> Rear parking distance sensors – audible warning.  Easier parking	○			237.50	285.00
Technical Pack <ul style="list-style-type: none"> Rear parking distance sensors • R4.0 IntelliLink – see infotainment section for details. 	○			500.00	600.00
Steering <ul style="list-style-type: none"> Speed-sensitive electric power-assisted steering 	●	●	●		
<ul style="list-style-type: none"> City mode button – Provides lighter steering at parking speeds 	●	●	●		
SECURITY					
Standard security features <ul style="list-style-type: none"> 'Key left in ignition' audible warning • Electronically protected audio equipment • Engine deadlock immobiliser Visible Vehicle Identification Number (VIN) • Locking wheel bolts for alloy wheels 	●	●	●		
Central locking <ul style="list-style-type: none"> Remote control • Operates on doors, tailgate and fuel filler flap • Deadlocking • Central locking activation switch on fascia One folding key/one static key each with integral remote control function (folding key is colour-keyed to body colour on ADAM JAM and ENERGISED models) 	●	●	●		

● = Standard equipment. ○ = Optional at extra cost.

ADAM FEATURES / OPTIONS

DRIVER INFORMATION	JAM	ENERGISED	GRIFFIN	Price (£) exc. VAT	Total (£) inc. VAT
Instrumentation <ul style="list-style-type: none"> • Black instruments with chrome edging • Speedometer • Rev counter • Fuel gauge with low fuel level warning light • Water temperature gauge • Instrument panel light dimmer • Shift-up indication light (Start/Stop models) – <i>Indicates when to change gear for optimum fuel economy</i> 	●	●	●		
Driver information display (centrally located in instrument cluster) <ul style="list-style-type: none"> • Displays trip computer data • Total mileage • Service-due indicator • Tyre pressure monitoring system • Handbrake-on / low brake fluid level warning lights 	●	●	●		
Central fascia display (format dependent on infotainment unit) <ul style="list-style-type: none"> • Audio information • Digital clock with automatic RDS time adjustment • Outside air temperature with ice warning function • Additional features dependent on infotainment unit (see infotainment for details) 	●	●	●		
Multi-function trip computer (displayed on driver information display) <ul style="list-style-type: none"> • Trip mileage • Vehicle range based on remaining fuel • Average fuel economy • Instantaneous fuel economy 	●	●	●		
INTERIOR STYLING					
JAM interior décor <ul style="list-style-type: none"> Steering wheel: • Three-spoke design • Leather-covered • Satin chrome-effect bezel Facia and door trim: • Japan Black facia and door panel inserts (Black Jack, Orange Alert and Pump up the Blue models) • Pearl White facia and door panel inserts (Saturday White Fever and Shades of Grey models) • Facia and door panel inserts matched to exterior colour (all other models) • Black door panels with black Atlantis cloth inserts • Chrome-effect interior door handles Seat trim: • Imix black fabric seat trim inserts • Plain black fabric side bolsters and surrounds 	●				
ENERGISED/GRIFFIN interior décor <ul style="list-style-type: none"> Steering wheel: • Three-spoke design • Leather-covered • Satin chrome-effect bezel Facia and door trim: • Japan Black facia and door panel inserts (Orange Alert, White My Fire and Shades of Grey models) • Facia and door panel inserts matched to exterior colour (all other models) • Black door panels with black leather-effect inserts • Chrome-effect interior door handles Seat trim: • Ocio black fabric seat trim inserts • Black leather-effect side bolsters and surrounds 		●	●		

● = Standard equipment.

ADAM FEATURES / OPTIONS

INFOTAINMENT	JAM	ENERGISED	GRIFFIN	Price (£) exc. VAT	Total (£) inc. VAT
CD 30 BT Onboard features: • CD/MP3 CD player • AM/FM stereo radio with 36 station presets • RDS with Traffic Programme Media connections: • USB connection with iPod control • Aux-in socket Mobile phone portal: • Bluetooth® connectivity • Handsfree calls via steering wheel controls • Vehicle microphone • Phone book access	●				
R4.0 IntelliLink touchscreen infotainment system <i>For use with media players, USB memory sticks, mobile phones and smartphone apps.</i> Onboard features: • 7-inch colour touchscreen • AM/FM stereo radio with 36 station presets • RDS with Traffic Programme Media connections: • USB connection with iPod control • Bluetooth® A2DP audio streaming (Advanced Audio Distribution Profile) Mobile phone portal: • Bluetooth® connectivity • Handsfree calls via steering wheel controls • Vehicle microphone • Phone book access – <i>The majority of the phone's functions – contacts/last calls/missed calls etc. – are mirrored on IntelliLink's display and are easily navigated using the touchscreen (features dependent on mobile phone).</i> Smartphone interface: • Apple CarPlay™ • Android Auto™ – <i>Smartphone projection that allows operations via voice command, touchscreen and buttons to control apps and music playback</i> Gallery – only available when the vehicle is stationary: • Photo gallery with slide show feature • Video playback with soundtrack played through car speakers	□	●			

● = Standard equipment. □ = Available as part of an extra-cost option pack.

ADAM FEATURES / OPTIONS



INFOTAINMENT

	JAM	ENERGISED	GRIFFIN	Price (£) exc. VAT	Total (£) inc. VAT
Navi 4.0 IntelliLink touchscreen navigation and infotainment system (not available in conjunction with Technical Pack) <i>For use with media players, USB memory sticks, mobile phones and smartphone apps.</i> Onboard features: • 7-inch colour touchscreen • AM/FM stereo radio with 36 station presets • RDS with Traffic Programme Navigation features: • Satellite navigation system • 2D street level mapping • European coverage • Structured or one-box destination entry • Points-of-interest search • Eco routing • Map updates via USB Media connections: • USB connection with iPod control • Bluetooth® A2DP audio streaming (Advanced Audio Distribution Profile) Mobile phone portal: • Bluetooth® connectivity • Handsfree calls via steering wheel controls • Vehicle microphone • Phone book access – <i>The majority of the phone's functions – contacts/last calls/missed calls etc. – are mirrored on IntelliLink's display and are easily navigated using the touchscreen (features dependent on mobile phone).</i> Smartphone interface: • Apple CarPlay™ • Android Auto™ – <i>Smartphone projection that allows operations via voice command, touchscreen and buttons to control apps and music playback.</i> Gallery – only available when the vehicle is stationary: • Photo gallery with slide show feature • Video playback with soundtrack played through car speakers	○		●	654.17	785.00
Digital radio		●	●		
Number of speakers	4*	4	4		
Steering wheel mounted audio controls	●	●	●		

● = Standard equipment. ○ = Optional at extra cost.

* = 6 speakers are fitted when optional Technical Pack or rear parking distance sensors are specified.

ADAM FEATURES / OPTIONS

	JAM	ENERGISED	GRIFFIN	Price (£) exc. VAT	Total (£) inc. VAT
HEATING AND VENTILATION					
Air conditioning • Air recirculation facility • Cabin particulate filter – <i>Removes dust, airborne particles and pollen</i> • Four-speed fan • Illuminated controls	●	●	●		
Winter Pack • Heated leather-covered steering wheel • Heated front seats  Warm welcome  	○			187.50	225.00
Additional features • Four adjustable facia vents • Windscreen demist vents • Side window demist vents • Heated rear screen with timed cut-off	●	●	●		
SEATING AND COMFORT					
Reach and rake adjustable steering	●	●	●		
Comfort front seats Driver's seat (eight-way adjustable): • Height (up/down) • Reach (fore/aft) • Backrest (upright/recline) • Head restraint (up/down) Front passenger's seat (six-way adjustable): • Reach (fore/aft) • Backrest (upright/recline) • Head restraint (up/down)	●	●	●		
Easy-entry front seats with memory function	●	●	●		
Rear seats • Two-person layout • 50/50 split-folding rear seat back • Removable head restraints • ISOFIX child seat mountings incorporating top tether anchor points located on rear seats (does not include child seat) – <i>Allows ISOFIX child safety seats to be securely fixed into the car. The ISOFIX mounting system reduces forward movement in an accident and makes the child seat easier to install.</i>	●	●	●		

● = Standard equipment. ○ = Optional at extra cost.

ADAM FEATURES / OPTIONS

	JAM	ENERGISED	GRIFFIN	Price (£) exc. VAT	Total (£) inc. VAT
INTERIOR CONVENIENCE					
Convenience features • Front 12-volt electrical accessory socket • Driver's and front passengers sunvisors • Driver's vanity mirror with cover • Dipping rear-view mirror • Driver's and front passenger's tiltable assist handles	●	●	●		
Automatically dimming anti-dazzle rear-view mirror	□				
Front and rear floor mats (front Griffin-branded)			●		
Interior lighting • Central front courtesy light • Fade up/fade down • Front map reading lights	●	●	●		
Interior storage • Storage box on driver's side lower fascia • Glovebox with lid • Front door pockets • Two drinks holders in rear of centre console • Rear stowage compartments in side panel	●	●	●		
Luggage area • Luggage compartment cover • Illuminated, carpeted, luggage area • Interior tailgate handles • Load restraint lashing eyes • Twin gas-assisted tailgate struts	●	●	●		
MECHANICAL					
Standard features • Front-wheel drive • Gas-pressure dampers • Front anti-roll bar • Speed-sensitive electric power-assisted steering	●	●	●		
• Sports suspension – fitted to JAM models in conjunction with optional 17-inch wheels. Not available separately.	○	●	●		

● = Standard equipment. ○ = Optional at extra cost. □ = Available as part of an extra-cost option pack.

ADAM FEATURES / OPTIONS

	JAM	ENERGISED	GRIFFIN	Price (£) exc. VAT	Total (£) inc. VAT
EXTERIOR LIGHTING					
Standard lighting features • Halogen headlights • Welcome lighting • Lights-on audible warning • Electric headlight beam levelling • High-level LED centre rear brake light • Rear fog light	●	●	●		
Daytime running lights	●	●	●		
Sight and Light Pack • Rain-sensitive windscreen wipers • Automatic lighting control with tunnel detection • Automatically dimming anti-dazzle rear-view mirror	○			200.00	240.00
EXTERIOR CONVENIENCE					
Windscreen wipers • Two-speed windscreen wipers with variable intermittent wipe • Intermittent rear window wash/wipe • Rain-sensitive windscreen wipers – <i>Fitted in conjunction with Sight and Light Pack. Not available separately.</i>	● □	●	●		
Door mirrors • Electrically adjustable/heated door mirrors (wide-angle on driver's side), manually foldable	●	●	●		
Windows • Electrically operated front windows with safety autoreverse and one-touch facility • Heated rear window with automatic timed cut-off	●	●	●		
EXTERIOR STYLING					
Body-colour door handles	●	●	●		
Body-colour roof and door mirrors	●				
Roof Colour Packs <i>The roof and door mirrors are available in a range of colours</i>					
• Black Jack	□	●	●	254.17	305.00
• White my Fire	□			254.17	305.00
Style Pack • Choice of Black Jack or White my Fire Roof Colour Pack • 17-inch Swiss Blade Silver alloy wheels • Dark-tinted rear windows	○			587.50	705.00
Chrome-effect front grille bar	●				
High-gloss black front grille bar		●	●		
Black B-pillars	●	●	●		
Windows • Tinted windows • Dark-tinted rear windows (also available as part of optional Style Pack)	● ○	● ○	●	145.83	175.00

● = Standard equipment. ○ = Optional at extra cost. □ = Available as part of an extra-cost option pack.

ADAM FEATURES / OPTIONS

EXTERIOR COLOURS		JAM	ENERGISED	GRIFFIN	Price (£) exc. VAT	Total (£) inc. VAT
	Orange Alert • Solid paint	●	N/C	N/C		
	Red 'n' Roll • Brilliant paint	○	●	●	237.50	285.00
	Saturday White Fever • Brilliant paint	○	N/C	N/C	237.50	285.00
	White my Fire • Brilliant paint		N/C	N/C	237.50	285.00

● = Standard equipment. ○ = Optional at extra cost. N/C = No-cost option.

The colours reproduced may vary slightly from the actual paint colour. As a result they should be used as a guide only. Your Vauxhall Retailer has a comprehensive display of our paint samples.

Colours and model variants for Griffin special edition subject to availability. Please check with your Vauxhall Retailer.

ADAM FEATURES / OPTIONS



EXTERIOR COLOURS		JAM	ENERGISED	GRIFFIN	Price (£) exc. VAT	Total (£) inc. VAT
	Black Jack • Two-coat metallic paint	○	N/C	N/C	470.83	565.00
	Shades of Grey • Two-coat metallic paint	○	N/C	N/C	470.83	565.00
	Let it Blue • Two-coat premium paint		N/C	N/C	545.83	655.00
	Pump up the Blue • Two-coat premium paint	○			545.83	655.00

○ = Optional at extra cost. N/C = No-cost option.

The colours reproduced may vary slightly from the actual paint colour. As a result they should be used as a guide only. Your Vauxhall Retailer has a comprehensive display of our paint samples.



Colours and model variants for Griffin special edition subject to availability. Please check with your Vauxhall Retailer.

ADAM FEATURES / OPTIONS

WHEELS AND TYRES		JAM	ENERGISED	GRIFFIN	Price (£) exc. VAT	Total (£) inc. VAT
Emergency spare wheel (in lieu of emergency tyre inflation kit)		○			91.67	110.00
	16-inch Horns Silver alloy wheels • 195/55 R 16 tyres • Emergency tyre inflation kit (in lieu of spare wheel)	●				
	17-inch Gloss Black Hurricane alloy wheels • 215/45 R 17 tyres • Emergency tyre inflation kit (in lieu of spare wheel)		●	●		
	17-inch Swiss Blade Silver alloy wheels • 215/45 R 17 tyres • Emergency tyre inflation kit (in lieu of spare wheel)	□				

● = Standard equipment. ○ = Optional at extra cost. □ = Available as part of an extra-cost option pack.

TYRE RATING

Tyre size	Fuel efficiency group	Wet grip performance	External noise	
			Measured (dB)	Group
195/55 R 16	B-C	B	71	
215/45 R 17	C	B	71	

Tyre rating according to EU Regulation 1222/2009

ADAM SPECIFICATIONS

PETROL ENGINE

1.2i (70PS)	
Capacity	1229cc
Maximum power	70PS (51kW) @ 5600rpm
Maximum torque	115Nm (85 lb.ft.) @ 4000rpm
Configuration	4 cylinders, 4 valves per cylinder, double overhead camshafts
Fuel/induction system	Naturally aspirated. Variable Valve Timing. Multi-point sequential fuel injection
Emission compliance	Euro 6d-TEMP (6.2)
Service interval	20,000 miles or 1 year (whichever occurs sooner)

PERFORMANCE, FUEL ECONOMY AND EMISSIONS

	Performance (manufacturer's figures)			Fuel economy mpg (litres/100km)#		CO ₂ emissions	Vehicle Excise Duty**		Benefit in kind company car taxation rates – 2019/20 tax year
	Wheel size	Maximum speed	Acceleration 0-62mph	Combined Low	Combined High		First year rate	Standard rate	
Manual									
1.2i (70PS)	16/17	103	14.9	41.5 (6.8)	44.8 (6.3)	128	£170	£145	29%

= Fuel consumption figures are determined according to the WLTP test cycle. Full data relating to WLTP test cycles can be found at: www.vauxhall.co.uk/wltp

*CO₂ emissions figures are determined according to the WLTP test cycle however, a Government formula is then applied to translate these figures back to what they would have been under the outgoing NEDC test cycle, which WLTP replaces. The correct tax treatment is then applied.

Figures are intended for comparability purposes only. The fuel consumption you achieve under real life driving conditions and CO₂ produced will depend upon a number of factors, including the accessories fitted after registration, variations in driving styles, weather conditions and vehicle load. Only compare fuel consumption and CO₂ with other vehicles tested using the same technical procedures. For more information contact your local Vauxhall Retailer.

** = Correct at time of publication.

ADAM SPECIFICATIONS

START/STOP TECHNOLOGY

The ADAM Start/Stop system offers real benefits by improving fuel economy and reducing CO₂ emissions, particularly in town. It does this by automatically stopping the engine when you come to a standstill, and then restarting as you prepare to move off.

Before automatically stopping the engine a number of system checks are carried out to ensure that it is both safe and practical to do so. To ensure safety, the driver must depress the clutch pedal, shift in to neutral, and then release the clutch pedal.

System checks carried out before Auto Stop activates include:

- Start/Stop system is not manually deactivated via the facia button
- Sufficient brake vacuum is available to prevent the car rolling down an incline
- Battery is in good condition and charged
- Outside air temperature and engine temperature are above specified minima
- Electronic climate control (where fitted) is not in maximum heating or maximum cooling mode

If all of these conditions are satisfied then the vehicle will Auto Stop.

When you are ready to pull away from standstill, Auto Restart is activated by depressing the clutch pedal.

Whilst at a standstill the vehicle is continually monitored. If necessary, the engine will automatically be restarted. Conditions that would initiate an Auto Restart include:

- Low battery level
- Cabin temperature is too high
- Driver's seatbelt unfastened or driver's door opened
- Bonnet is released or opened

TRANSMISSION

Five-speed manual gearbox:
Standard on all models

STEERING

- Speed-sensitive power-assisted steering

SUSPENSION

Front: Independent. MacPherson struts with gas-pressure dampers and coil springs. Anti-roll bar.

Rear: Compound crank with coil springs and gas-pressure dampers.

BRAKING AND STABILITY

- Electronic Stability Programme
 - Cornering brake control
 - Straight line stability control
 - Anti-lock Braking System (ABS)
 - Electronic brakeforce distribution
 - Emergency brake assist
 - Dual circuit, diagonally split braking system
- Front ventilated discs: 257mm diameter
Rear drums: 203mm diameter

FUEL TANK CAPACITY

- 38 litres (8.4 gallons)

GROSS VEHICLE WEIGHTS kg

1.2i (70PS)	1470
-------------	------

Gross vehicle weight is the total permissible weight of the vehicle including passengers and luggage. The maximum roof rack loading should not exceed 50kg.

INSURANCE GROUPS

1.2i (70PS)	3E
-------------	----

ADAM SPECIFICATIONS

EXTERIOR DIMENSIONS millimetres (inches)

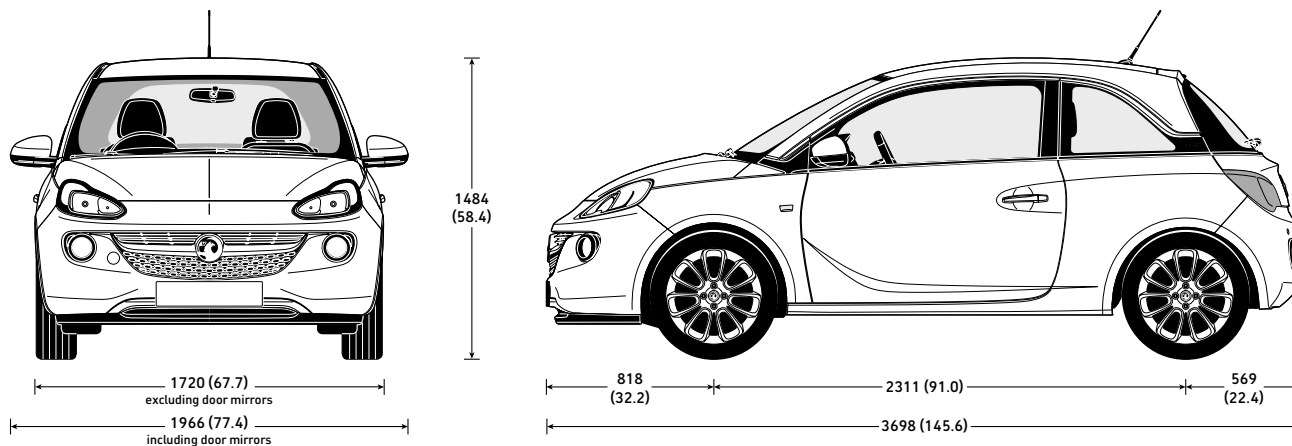

LOADSPACE DIMENSIONS mm (inches)

Maximum length (behind rear seats)	462 (18.2)
Maximum length (rear seats folded)	1041 (41.0)
Maximum width	963 (37.9)
Width between wheel arches	954 (37.6)
Maximum height	874 (34.4)

LOADSPACE CAPACITIES* litres (cu.ft.)

Rear seats up (under luggage compartment cover)	170 (6.0)
Rear seats folded (to upper edge of front seat back)	484 (17.1)
Rear seats folded (to roof)	663 (23.4)

* = Measured using the ECIE method.

ADAM ACCESSORIES

	Total (inc. VAT)
CHILD SEATS¹	
BABY-SAFE2 – 0–13kg/birth to 15 months	£141
– ISOFIX base	£244
DUO ISOFIX2 – 9–18kg/9 months to 4 years	
with top tether kit	£372
KID2 –15–36kg or 4 to 12 years	£168

1 = Restrictions apply to the use of child seats, please consult your Vauxhall Retailer or request a copy of the Child seats brochure.

2 = Without transponder.

	Total (inc. VAT)
FLEXCONNECT RANGE	
FlexConnect bracket	£22
FlexConnect hook	£32
FlexConnect coat hanger	£34
FlexConnect folding table	£77
FlexConnect iPad Mini cradle	£109
FlexConnect iPad (1-4) cradle	£118
FlexConnect iPad Air cradle	£117
FlexConnect Samsung Galaxy cradle	£107

	Total (inc. VAT)
INTERIOR	
Velour floor mats (set of four)	from £61
Rubber floor mats (set of four)	£51
Rear view mirror cap (fitted)	from £59
Front console mat	£43
Centre console armrest (fitted)	£121
Cargo box with lid	£209
Stainless steel pedal covers	
– manual (fitted)	£164

	Total (inc. VAT)
EXTERIOR STYLING³	
VX-Line body styling – front lower spoiler/side sills/rear lower skirts (painted/fitted)	£1,687
VX-Line body styling – rear roof spoiler (painted/fitted)	£577

3 = Not available on S models.

Please note:

Prices shown are fully fitted and painted, where applicable and include VAT. Please check with your local Vauxhall Retailer for details. It is advisable to ensure your insurance policy is adequate to cover additional fitted accessories. Prices correct at time of publication.

	Total (inc. VAT)
EXTERIOR	
Door mirror caps (fitted)	from £119
Painted radiator grille (fitted)	from £108
'Fly' graphics	
– B-pillar decal (fitted)	£65
– C-pillar decal (fitted)	£152
'Splat' graphics	
Front wing/rear quarter decals (fitted)	from £158
'Sport 01' graphics	
– Bonnet decal (fitted)	£119
– Roof decal (fitted)	£201
– C-pillar decal (fitted)	£79

'Stripes' graphics	
– Bonnet decal (fitted)	from £162
– Roof decal (fitted)	from £157
– Door decals (fitted)	from £139
– Door / door mirror decals (fitted)	from £139
'Stars and Stripes' graphics	
– Roof / B Pillar decals (fitted)	£209
'Chequered' graphics	
– Roof decal (fitted)	£130
'Motorsport' graphics	
– Bonnet / body side decals (fitted)	£427
Body side protection mouldings (painted/fitted)	£237

	Total (inc. VAT)
PROTECTION	
Tyre sealant – 450ml	£80
Tyre repair kit	£121
Safety Pack – first aid kit, hi-visibility vest and small warning triangle	£30
Warning triangle – Small	£12
Warning triangle – Large	£20
First aid kit	£15
Hi-visibility vest	£9
Fire extinguisher – 2kg	£39
Spare bulb kit	£27
Protection film – front bumper (fitted)	£181
Protection film – rear bumper (fitted)	£43
Privacy shades – tailgate/rear side windows	£192
Exterior windscreen cover	£51
Outdoor car cover	£106

	Total (inc. VAT)
TRANSPORT SYSTEMS	
Roof base carrier	£154
Roof carriers (requires base carrier)	
Bike roof carrier – Thule Freeride 532	£78
Surf board roof carrier – Thule 833	£82
Kayak roof carrier – Thule 837	£172
Ski roof carrier (up to 4 pairs)	
– Thule 7234	£161
Ski roof carrier (up to 6 pairs)	
– Thule 7326	£190

Hard shell roof boxes (requires base carrier)	
Thule Ocean 80 (320 litre / 1330 x 860 x 370mm)	£154
Thule Ocean 200 (450 litre / 1750 x 820 x 450mm)	£323
Thule Motion 800 (460 litre / 2050 x 840 x 450mm)	from £463
Thule Touring 200 (400 litre / 1750 x 820 x 450mm)	£338
Thule Touring 700 (430 litre / 2320 x 700 x 420mm)	£384

	Total (inc. VAT)
ALLOY WHEELS (set of four with centre caps)⁴	
16-inch Horns	
– Silver	£1,287
– Black	£1,281
16-inch Vintage	£1,287
16-inch Boomerang	
– Grey / diamond cut face	£1,281
– Green / diamond cut face	£1,281
– White / diamond cut face	£1,281
16-inch Triple Cross	
– Titan grey	£1,287
– Manoogian	£1,281
18-inch Turbine	£1,838
17-inch Hurricane	
– Manoogian	£1,415
– Black	£1,415
– White	£1,281
17-inch Swiss Blade	
– Silver	£1,302
– Black / white rim	£1,480
– Black / red rim	£1,480
– Black / blue rim	£1,480
17-inch Roulette	
– Grey	£1,281
– Grey / diamond cut face	£1,458
– Grey / white face	£1,458
– Grey / brown face	£1,458
– Grey / green face	£1,458
– Copper / white face	£1,458
– Copper / diamond cut face	£1,458
– Black gloss	£1,458
18-inch Twister	
– Grey	£2,078
– Manoogian	£2,078
Coloured wheel clips for Twister wheels (set of four)	from £56
Tyre valve caps with Vauxhall logo – set of four	£24

4 = Different tyres and locking wheel bolts/nuts may be required at extra cost. Price excludes new tyres and locking wheel bolts/nuts, includes static wheel balancing.

ADAM COMPANY CAR DRIVER/FLEET INFORMATION



COMPANY CAR DRIVER FREE 3 DAY TEST DRIVE

Our free* 3 Day Test Drive programme is open to all Company Car Drivers. It allows you to choose most models in the current Vauxhall line-up (exclusions apply). With full insurance cover provided, it gives you a meaningful length of time to make an informed decision about your next company car.

Search Vauxhall 3DTD to book your FREE* test drive or click the link the below:

[Vauxhall 3 Day Test Drive](#)

*The free 3 Day Test Drive programme is open to Company Car Drivers and Fleet Decision Makers. Available for UK Mainland only. Terms and conditions apply. Full terms and conditions can be found at vauxhallfleet.co.uk/testdrive/index/terms.

FLEET TOOLBOX

Discover the facts in our online Toolbox for both Company Car Drivers and Fleet Decision Makers. The Fleet Toolbox has a host of useful calculators, comparators, interactive listings and information.

Search Vauxhall Fleet Tools or click the link below:

[Vauxhall Fleet Tool Box](#)



BENEFIT IN KIND COMPANY CAR TAXATION†

The car benefit charge will be the car's list price (including VAT, options and accessories fitted, delivery to Retailer and number plates, but excluding Vehicle Excise Duty and new vehicle first registration fee) multiplied by the percentage charge for the CO₂ emissions band in which the car falls (see table opposite). Multiply this figure by your personal income tax rate (20%†† for Basic Rate, 40%†† for Higher Rate) to calculate your annual benefit in kind tax liability.

Example:

ADAM JAM 1.2i (70PS)
(CO₂ emissions 128g/km)

On-the-road RRP	£13855.00
Deduct: Vehicle Excise Duty	(£170.00)
New vehicle first registration fee	(£55.00)
Effective list price	£13630.00
Add: Optional two-coat metallic paint	
	£565.00

List price for tax purposes (P11D value)
£14195.00

Car benefit charge
2019-20 tax year (29%) £4117.00

Benefit in kind tax liability (2019-20 tax year)	
Basic Rate (20%) tax payer	£823.40
Higher Rate (40%) tax payer	£1646.80

† = Please note this Price Guide provides taxation information as a guide only. Vauxhall does not provide taxation guidance. Drivers should always take professional advice on their own tax position. †† = Excludes residents of Scotland.

BIK FOR SCOTTISH RESIDENTS

Effective 6 April 2018 the Scottish Government have introduced their own BIK taxation structure. This only applies to Company Car Drivers that are Scottish taxpayers. HMRC will determine whether or not an individual is a Scottish taxpayer based on where their main place of residence is.

The BIK rates for Scotland are:

- Over £12,500-£14,549 Starter Rate 19%
- Over £14,549-£24,994 Basic Rate 20%
- Over £24,994-£43,430 Intermediate Rate 21%
- Over £43,430-£150,000 Higher Rate 41%
- Above £150,000 Top Rate 46%

CO ₂ emissions in grams per kilometre	Percentage of car's price to be taxed	
	Non - Diesel† 2019-20 tax year	Diesel†† 2019-20 tax year
Up to 50	16	20
51-75	19	23
76-94	22	26
95-99	23	27
100-104	24	28
105-109	25	29
110-114	26	30
115-119	27	31
120-124	28	32
125-129	29	33
130-134	30	34
135-139	31	35
140-144	32	36
145-149	33	37
150-154	34	37
155-159	35	37
160-164	36	37
165-169	37	37
170-174	37	37
175-179	37	37
180 and above	37	37

† = Also applies to diesel vehicles that meet the Real Driving Emissions Step 2 (RDE2). †† = Applies to vehicles that do not meet the Real Driving Emissions Step 2 (RDE2).

To calculate your own personal liability, search: **Vauxhall BiK**, or click the link below:

[Vauxhall BiK Tool](#)

CONTACT VAUXHALL FLEET

Please contact one of our dedicated sales teams who will be happy to help with your particular enquiry.

Company Car Drivers

Call: 0345 111 2020

Email: company-car@vauxhallinfo.co.uk

Telephone lines are open

– Monday to Friday 8.00am-9.00pm

– Saturday and Sunday 9.00am-6.00pm

Fleet Decision Makers

Depending on the size of your fleet of vehicles, we have a dedicated team to handle your enquiries.

The lines are open Monday to Friday excluding Bank Holidays.

1-24 vehicles

Call: 0845 076 2254 (8.30am-5.00pm)

25+ vehicles

Call: 0330 587 8222 (8.30am-5.00pm)

Email: vauxhallfleet@vauxhall.co.uk

Special Vehicles (Police, Fire and Ambulance)

Call: 01582 409999 (8.30am-5.00pm)

Email: vauxhallspecialvehicles@vauxhall.co.uk

ADAM ADDITIONAL INFORMATION

ON-THE-ROAD PRICES

To eliminate uncertainty about hidden costs when buying a new car, Vauxhall publishes on-the-road recommended retail prices (RRP) and these are shown in the pricing tables within this price guide. These prices include VAT, number plates and delivery to Retailer of £700.00 (including £116.67 VAT), 12 months' Government Vehicle Excise Duty (see opposite for details) and the DVLA new vehicle first registration fee of £55.00*.

Please note: The on-the-road recommended retail price (RRP) does not include fuel supplied by the Retailer, motor insurance or any other goods or services supplied by agreement between the Retailer and the customer.

PRICE PROTECTION

Order a new Vauxhall for build in the current model year (as confirmed by your Retailer) for delivery no more than three months in advance and the price you are quoted is the price you pay. This is irrespective of any subsequent price rises between placing your order and delivery of your new car, but you must take delivery as soon as the car is available. Vauxhall Motors Limited is not liable for price adjustments caused by Government changes in the rate of VAT (currently 20%), Vehicle Excise Duty, DVLA new vehicle first registration fee or by any other applicable legislation or regulations.

VAUXHALL FINANCE LEASING

Vauxhall Finance Leasing is a trading style of Vauxhall Finance plc. Working with the Vauxhall Retailer network we provide competitive car and van leasing solutions for business users and private individuals. We combine the support of a national contract with the convenience of a local contact. For further information, please contact your local Vauxhall Retailer or visit www.vauxhall.co.uk/leasing

IN THE EVENT OF AN ACCIDENT...

Vauxhall Accident Management helps keep you mobile following an accident. Benefits include vehicle recovery, Vauxhall-approved repairs and contacting your insurer. For more details, visit vauxhall.co.uk/AccidentManagement

VEHICLE EXCISE DUTY

The amount of Vehicle Excise Duty (road fund licence) payable on new cars varies depending on the level of carbon dioxide (CO₂) emissions produced by the vehicle. CO₂ emissions are measured in grammes (g) per kilometre (km) travelled and divided into 13 charging bands shown in the table below.

A 'first year rate' of Vehicle Excise Duty is payable on all new cars and in subsequent years the amount payable reverts to the 'standard rate'. From 1 April 2017 the breakpoints for each of these bands have been revised. Also, for vehicles with a list price over £40,000, including factory-fitted options, an additional £320 is payable for the first five years of standard rate payments.

VEHICLE EXCISE DUTY*

	CO ₂ emissions	First year rate		Standard rate
		Non-diesel**	Diesel†	
Band A	0g/km	£0.00	£0.00	£0.00
Band B	1 – 50g/km	£10.00	£25.00	£145.00
Band C	51 – 75g/km	£25.00	£110.00	£145.00
Band D	76 – 90g/km	£110.00	£130.00	£145.00
Band E	91 – 100g/km	£130.00	£150.00	£145.00
Band F	101 – 110g/km	£150.00	£170.00	£145.00
Band G	111 – 130g/km	£170.00	£210.00	£145.00
Band H	131 – 150g/km	£210.00	£530.00	£145.00
Band I	151 – 170g/km	£530.00	£855.00	£145.00
Band J	171 – 190g/km	£855.00	£1,280.00	£145.00
Band K	191 – 225g/km	£1,280.00	£1,815.00	£145.00
Band L	226 – 255g/km	£1,815.00	£2,135.00	£145.00
Band M	over 255g/km	£2,135.00	£2,135.00	£145.00

* = Correct at time of issue. ** = Also applies to diesel vehicles that meet the Real Driving Emissions Step 2 (RDE2).

† = Applies to vehicles that do not meet the Real Driving Emissions Step 2 (RDE2).

TRUST VAUXHALL

CUSTOMER CARE COMMITMENT

For added peace of mind, Vauxhall has an innovative Customer Care Commitment that offers the following:

- Three-year vehicle warranty consisting of a one-year/unlimited mileage manufacturer's warranty and a second and third year manufacturer's warranty with a 60,000 miles limitation
- Vauxhall Assistance for 12 months from first registration
- Six years' body panel anti-perforation warranty

Please note: Warranty is only available on vehicles sourced from Vauxhall Motors Limited. Terms and conditions apply – please see your Vauxhall Retailer for details.

VAUXHALL ASSISTANCE

Vauxhall Assistance is provided automatically with every new Vauxhall for 12 months from first registration and covers everything from accident assistance, roadside recovery and 'at home' service to flat tyres. With Vauxhall Assistance help is literally just a free* phone call away, 24 hours a day, 365 days a year!

* = Mobile phone users will be charged at their standard tariff.

PROTECTING THE ENVIRONMENT

Vauxhall's commitment to the environment is demonstrated by our products' many environmental awards. For even more information on Vauxhall's efforts to achieve an environmentally sustainable future, and how to dispose of your end-of-life vehicle, see www.vauxhall.co.uk/recycling

VAUXHALL SERVICE PLAN

- Fixed monthly payments for the plan duration
- Easy to budget and interest-free
- Genuine parts fitted by Vauxhall-trained technicians

Plus on Gold plans:

- Valet and courtesy car
- Vauxhall Roadside Assistance
- Engine flush and fuel treatments
- Litre of oil for top ups between services

Full details can be obtained from your local participating Vauxhall Retailer.

VAUXHALL INSURANCE WITH ADDED REASSURANCE

Comprehensive cover – Summary of benefits**

- Competitive premiums
- Repairs by a Vauxhall-trained technician
- Genuine Vauxhall parts, guaranteed for three years when we repair your car within our Approved Repairer Network
- Free courtesy car as standard when using an Approved Repairer†
- 24 hour claims helpline
- Personal Accident benefit
- Cover for audio equipment
- Windscreen cover

Call for a quote on 0844 463 2670††

** = The benefits listed above are for comprehensive cover only. For details of Third Party, Fire and Theft cover, please call our sales team.
† = Should your car need repairing following an accident we provide a courtesy car (subject to availability) for the duration of the repair. Only genuine Vauxhall parts are used. Terms and conditions apply.
†† = Calls may be recorded. Vauxhall Insurance is underwritten by Ageas Insurance Limited.

FOR MORE PRODUCT INFORMATION

For further information on the Vauxhall range or location of your nearest Vauxhall Retailer please call **0345 600 1500**. Alternatively, details can be found on our website at www.vauxhall.co.uk

JOIN US ONLINE:



Privacy Policy – For full details please visit: vauxhall.co.uk/privacy

The invoice price, including delivery to Retailer, factory-fitted options, accessories fitted by the Retailer and number plates, is subject to VAT. Some feature descriptions in this guide may refer to, and some illustrations may show, optional equipment not included in the standard delivery. The information contained in this guide was accurate at the time of publication. We reserve the right to make changes in design and equipment. Please note that Vauxhall Retailers are not the agents of Vauxhall Motors Limited and are not authorised to bind Vauxhall Motors Limited by any specific or implied undertaking or representation. It is advisable to ensure that your motor insurance policy provides adequate cover for additional fitted options and accessories. The colours in this guide are only approximate actual colours. Illustrated optional equipment is available at extra charge. Availability, technical features and equipment provided on our vehicles can vary by model. For precise information on the equipment provided on our vehicles, please contact your local Vauxhall Retailer.

VAUXHALL

vauxhall.co.uk

©2019 Vauxhall Motors Limited

Published 1 April 2019 (Amended 9 May 2019) Vauxhall Motors Limited, Luton LU4 9TT

CORSA

Price and Specification Guide | 24 May 2019 | Model Year 2019.5



VAUXHALL
British Brand since 1903

CONTENTS

To find the information you want use the links below to navigate around the guide:

[RANGE HIGHLIGHTS >](#)

Explore the Corsa range and find your perfect model.

[MODELS >](#)

Find all the information you need about your chosen model.

[PRICES >](#)

Find on-the-road recommended retail prices.

[FEATURES/OPTIONS >](#)

Tailor your chosen model to suit your needs with everything from satellite navigation to rear-view camera and parking sensors.

[EXTERIOR COLOURS >](#)

Add some sparkle to your car with a metallic paint.

[WHEELS AND TYRES >](#)

Why not upgrade to a set of distinctive alloy wheels to give your car more presence.

[PERFORMANCE, FUEL ECONOMY AND EMISSIONS >](#)

Know how many miles you will get around town, the CO₂ figures and the 0-60 time.

[DIMENSIONS >](#)

Ensure your car will fit in the garage and know how much luggage you can take for a long weekend away.

[SPECIFICATIONS >](#)

Towing weights, engine details and other useful details you may need to know.

[ACCESSORIES >](#)

Add some practical touches to your car with our range of quality accessories.

[COMPANY CAR INFORMATION >](#)

Benefit in Kind company car tax, 3 day test drives and P11D.

[FURTHER INFORMATION >](#)

Price protection, vehicle excise duty, our range of additional products and much more.

CORSA RANGE HIGHLIGHTS



STANDARD FEATURES

Standard features include:

Infotainment:

- Six speakers

Interior convenience/styling:

- Cruise control
- Speed-sensitive power-assisted steering
- Steering column adjustable for reach/rake
- Steering wheel audio/phone/cruise controls
- Driver's seat height adjuster

Exterior convenience/styling:

- Heated windscreen
- Remote control central locking
- Electrically operated front windows
- Electrically adjustable door mirrors
- Black B-pillars (with certain exterior colours)

Safety/security:

- Electronic Stability Programme (ESP)
- Anti-lock Braking System (ABS)
- Six airbags
- Hill start assist
- Seatbelt reminders for all seats
- ISOFIX child seat mounting points on outer rear seats
- Tyre pressure monitoring system
- Daytime running lights
- Engine deadlock immobiliser

ACTIVE

OTR from £11,735

Additional over standard features:

Infotainment:

- CD 30 BT audio system
 - AM/FM radio
 - CD/MP3 CD player
 - Bluetooth® mobile phone portal
 - USB audio connection
 - Aux-in socket

Interior convenience/styling:

- Leather-covered steering wheel

Exterior convenience/styling:

- 15-inch silver 8-spoke alloy wheels



DESIGN

OTR from £13,465

Additional over standard features:

Infotainment:

- IntelliLink audio system
 - 7-inch colour touchscreen
 - AM/FM/DAB digital radio
 - Bluetooth® audio streaming
 - Bluetooth® mobile phone portal
 - Apple CarPlay™/Android Auto™
 - USB audio connection

Interior convenience/styling:

- Air conditioning
- Leather-covered steering wheel

Exterior convenience/styling:

- Front fog lights
- 15-inch structure steel wheels with styled wheel covers



ENERGY

OTR from £14,825

Additional over standard features:

Infotainment:

- IntelliLink audio system
 - 7-inch colour touchscreen
 - AM/FM/DAB digital radio
 - Bluetooth® audio streaming
 - Bluetooth® mobile phone portal
 - Apple CarPlay™/Android Auto™
 - USB audio connection

Interior convenience/styling:

- Air conditioning
- Heated leather-covered steering wheel
- Heated front seats

Exterior convenience/styling:

- Electrically adjustable/heated door mirrors
- Automatic lighting control
- Rain-sensitive windscreen wipers
- Front fog lights
- 16-inch silver 4-twinspoke alloy wheels

CORSA RANGE HIGHLIGHTS



STANDARD FEATURES

Standard features include:

Infotainment:

- Six speakers

Interior convenience/styling:

- Cruise control
- Speed-sensitive power-assisted steering
- Steering column adjustable for reach/rake
- Steering wheel audio/phone/cruise controls
- Driver's seat height adjuster

Exterior convenience/styling:

- Heated windscreen
- Remote control central locking
- Electrically operated front windows
- Electrically adjustable door mirrors
- Black B-pillars (with certain exterior colours)

Safety/security:

- Electronic Stability Programme (ESP)
- Anti-lock Braking System (ABS)
- Six airbags
- Hill start assist
- Seatbelt reminders for all seats
- ISOFIX child seat mounting points on outer rear seats
- Tyre pressure monitoring system
- Daytime running lights
- Engine deadlock immobiliser

GRIFFIN PRICE AVAILABLE ON REQUEST FROM RETAILER

Additional over standard features:

Infotainment:

- Navi 4.0 IntelliLink satellite navigation system
 - Fully integrated European satellite navigation system
 - 7-inch colour touchscreen
 - AM/FM/DAB digital radio
 - Bluetooth® audio streaming
 - Bluetooth® mobile phone portal
 - Apple CarPlay™/Android Auto™
 - USB audio connection

Interior convenience/styling:

- Air conditioning
- Auto anti-dazzle rear-view mirror
- Sports-style heated front seats
- Leather-covered heated steering wheel
- Front and rear floor mats (front Griffin-branded)

Exterior convenience/styling:

- Roof/door mirrors/front grille bar in black
- Auto lighting/windscreen wipers
- 16-inch black 4-twinspoke alloy wheels
- Dark-tinted rear windows
- Front fog lights

Safety/security:

- LED daytime running lights

Colours and model variants for Griffin special edition subject to availability. Please check with your Vauxhall Retailer.



SPORT

OTR from £15,805

Additional over standard features:

Infotainment:

- IntelliLink audio system
 - 7-inch colour touchscreen
 - AM/FM/DAB digital radio
 - Bluetooth® audio streaming
 - Bluetooth® mobile phone portal
 - Apple CarPlay™/Android Auto™
 - USB audio connection

Interior convenience/styling:

- Air conditioning
- Leather-covered steering wheel
- Sports-style front seats
- Alloy-effect sports pedals

Exterior convenience/styling:

- Electrically adjustable/heated door mirrors
- Dark-tinted rear windows
- 16-inch silver 4-twinspoke alloy wheels



SRI NAV

OTR from £16,805

Additional over standard features:

Infotainment:

- Navi 4.0 IntelliLink satellite navigation system
 - Fully integrated European satellite navigation system
 - 7-inch colour touchscreen
 - AM/FM/DAB digital radio
 - Bluetooth® audio streaming
 - Bluetooth® mobile phone portal
 - Apple CarPlay™/Android Auto™
 - USB audio connection

Interior convenience/styling:

- Air conditioning
- Leather-covered steering wheel
- Sports-style front seats

Exterior convenience/styling:

- Rain-sensitive windscreen wipers
- Automatic lighting control
- Electrically adjustable/heated door mirrors
- Front fog lights with chrome-effect surround
- 16-inch black 4-twinspoke alloy wheels (3-door)
 - no-cost option on 5-door models
- 16-inch silver 4-twinspoke alloy wheels (5-door)
 - no-cost option on 3-door models

CORSA RANGE HIGHLIGHTS



STANDARD FEATURES

Standard features include:

Infotainment:

- Six speakers

Interior convenience/styling:

- Cruise control
- Speed-sensitive power-assisted steering
- Steering column adjustable for reach/rake
- Steering wheel audio/phone/cruise controls
- Driver's seat height adjuster

Exterior convenience/styling:

- Heated windscreen
- Remote control central locking
- Electrically operated front windows
- Electrically adjustable door mirrors
- Black B-pillars (with certain exterior colours)

Safety/security:

- Electronic Stability Programme (ESP)
- Anti-lock Braking System (ABS)
- Six airbags
- Hill start assist
- Seatbelt reminders for all seats
- ISOFIX child seat mounting points on outer rear seats
- Tyre pressure monitoring system
- Daytime running lights
- Engine deadlock immobiliser

SE NAV

OTR from £16,125

Additional over standard features:

Infotainment:

- Navi 4.0 IntelliLink satellite navigation system
 - Fully integrated European satellite navigation system
 - 7-inch colour touchscreen
 - AM/FM/DAB digital radio
 - Bluetooth® audio streaming
 - Bluetooth® mobile phone portal
 - Apple CarPlay™/Android Auto™
 - USB audio connection

Interior convenience/styling:

- Auto anti-dazzle rear-view mirror
- Air conditioning
- Multi-function trip computer
- Heated leather-covered steering wheel
- Heated front seats
- 60/40 split-folding rear seat back

Exterior convenience/styling:

- Auto lighting/windscreen wipers
- Electrically adjustable/heated door mirrors
- Front/rear parking sensors
- Front fog lights
- Chrome-effect lower side window mouldings (5-door only)
- 16-inch multi-spoke alloy wheels

SRi VX-LINE NAV BLACK

OTR from

£17,495

Additional over standard features:

Infotainment:

- Navi 4.0 IntelliLink satellite navigation system
 - Fully integrated European satellite navigation system
 - 7-inch colour touchscreen
 - AM/FM/DAB digital radio
 - Bluetooth® audio streaming
 - Bluetooth® mobile phone portal
 - Apple CarPlay™/Android Auto™
 - USB audio connection

Interior convenience/styling:

- Air conditioning
- Sports-style front seats
- VX-Line styling: Leather-covered flat-bottom steering wheel/gear knob/handbrake lever

Exterior convenience/styling:

- VX-Line body styling: Front lower spoiler/side sills/rear skirt/VXR rear roof spoiler (3-door only)
- Roof/door mirrors/front grille bar in black
- Dark-tinted rear windows
- Sports suspension
- Front fog lights
- 17-inch black alloy wheels

ACTIVE



ACTIVE ON-THE-ROAD PRICES

	3-door hatchback		Insurance
	OTR RRP	CO ₂ (g/km)	Group
Petrol			
1.4i (75PS)	£11,735	128	3E

Please note: On-the-road recommended retail prices (RRP) include VAT at 20%, number plates and delivery to Retailer of £700.00 (inc. £116.67 VAT), 12 months' Vehicle Excise Duty and new vehicle first registration fee of £55.00. Excludes fuel and insurance.

FEATURES

Infotainment:

- CD 30 BT audio system
 - AM/FM radio
 - CD/MP3 CD player
 - Bluetooth® mobile phone portal
 - USB audio connection
 - Aux-in socket
- Six speakers

Interior convenience/styling:

- Cruise control
- Leather-covered steering wheel
- Speed-sensitive power-assisted steering
- Steering column adjustable for reach/rake
- Steering wheel audio/phone/cruise controls
- Driver's seat height adjuster

Exterior convenience/styling:

- Heated windscreen
- Remote control central locking
- Electrically operated front windows
- Electrically adjustable door mirrors
- Black B-pillars (with certain exterior colours)
- 15-inch silver 8-spoke alloy wheels

Safety/security:

- Electronic Stability Programme (ESP)
- Anti-lock Braking System (ABS)
- Six airbags
- Hill start assist
- Seatbelt reminders for all seats
- ISOFIX child seat fixings on outer rear seats
- Tyre pressure monitoring system
- Daytime running lights
- Engine deadlock immobiliser

DESIGN



DESIGN ON-THE-ROAD PRICES

	3-door hatchback		5-door hatchback		Insurance Group
	OTR RRP	CO ₂ (g/km)	OTR RRP	CO ₂ (g/km)	
Petrol					
1.4i (75PS)	£13,465	128	£14,025	128	3E
1.4i (90PS) S/S	-	-	£14,515	123	6E
1.4i (90PS) automatic	-	-	£15,675	143	6E

Please note: On-the-road recommended retail prices (RRP) include VAT at 20%, number plates and delivery to Retailer of £700.00 (inc. £116.67 VAT), 12 months' Vehicle Excise Duty and new vehicle first registration fee of £55.00. Excludes fuel and insurance.

S/S = Start/Stop.



FEATURES

Infotainment:

- IntelliLink audio system
 - 7-inch colour touchscreen
 - AM/FM/DAB digital radio
 - Bluetooth® audio streaming
 - Bluetooth® mobile phone portal
 - Apple CarPlay™/Android Auto™
 - USB audio connection
- Six speakers

Interior convenience/styling:

- Air conditioning
- Cruise control
- Leather-covered steering wheel
- Speed-sensitive power-assisted steering
- Steering column adjustable for reach/rake
- Steering wheel audio/phone/cruise controls
- Driver's seat height adjuster

Exterior convenience/styling:

- Heated windscreen
- Remote control central locking
- Electrically operated front windows
- Electrically adjustable door mirrors
- Front fog lights
- Black B-pillars (with certain exterior colours)
- 15-inch structure steel wheels with styled wheel covers

Safety/security:

- Electronic Stability Programme (ESP)
- Anti-lock Braking System (ABS)
- Six airbags
- Hill start assist
- Seatbelt reminders for all seats
- ISOFIX child seat fixings on outer rear seats
- Tyre pressure monitoring system
- Daytime running lights
- Engine deadlock immobiliser

ENERGY



ENERGY ON-THE-ROAD PRICES

	3-door hatchback		5-door hatchback		Insurance Group
	OTR RRP	CO ₂ (g/km)	OTR RRP	CO ₂ (g/km)	
Petrol					
1.4i (75PS)	£14,825	128	£15,385	128	3E
1.4i (90PS) S/S	£15,325	124	£15,885	123	6E
1.4i (90PS) automatic	£16,435	136	£17,035	143	6E
1.4i Turbo (100PS) S/S	-	-	£16,245	125	11E

Please note: On-the-road recommended retail prices (RRP) include VAT at 20%, number plates and delivery to Retailer of £700.00 (inc. £116.67 VAT), 12 months' Vehicle Excise Duty and new vehicle first registration fee of £55.00. Excludes fuel and insurance.

S/S = Start/Stop.

FEATURES

Infotainment:

- IntelliLink audio system
 - 7-inch colour touchscreen
 - AM/FM/DAB digital radio
 - Bluetooth® audio streaming
 - Bluetooth® mobile phone portal
 - Apple CarPlay™/Android Auto™
 - USB audio connection
- Six speakers

Interior convenience/styling:

- Air conditioning
- Heated leather-covered steering wheel
- Heated front seats
- Cruise control
- Speed-sensitive power-assisted steering
- Steering column adjustable for reach/rake
- Steering wheel audio/phone/cruise controls
- Driver's seat height adjuster

Exterior convenience/styling:

- Heated windscreen
- Remote control central locking
- Electrically operated front windows
- Electrically adjustable/heated door mirrors
- Automatic lighting control
- Rain-sensitive windscreen wipers
- Front fog lights
- Black B-pillars (with certain exterior colours)
- 16-inch silver 4-twinspoke alloy wheels

Safety/security:

- Electronic Stability Programme (ESP)
- Anti-lock Braking System (ABS)
- Six airbags
- Hill start assist
- Seatbelt reminders for all seats
- ISOFIX child seat fixings on outer rear seats
- Tyre pressure monitoring system
- Daytime running lights
- Engine deadlock immobiliser

GRIFFIN



GRIFFIN PRICE AVAILABLE ON REQUEST FROM RETAILER

	3-door hatchback CO ₂ (g/km)	5-door hatchback CO ₂ (g/km)	Insurance Group
Petrol			
1.4i (75PS)	128	128	4E
1.4i (90PS)	128	128	7E
1.4i (90PS) S/S	124	123	7E
1.4i (90PS) automatic	136	143	7E

Please note: On-the-road recommended retail prices (RRP) include VAT at 20%, number plates and delivery to Retailer of £700.00 (inc. £116.67 VAT), 12 months' Vehicle Excise Duty and new vehicle first registration fee of £55.00. Excludes fuel and insurance.

S/S = Start/Stop.

Colours and model variants for Griffin special edition subject to availability. Please check with your Vauxhall Retailer.

FEATURES

Infotainment:

- Navi 4.0 IntelliLink satellite navigation system
 - Fully integrated European satellite navigation system
 - 7-inch colour touchscreen
 - AM/FM/DAB digital radio
 - Bluetooth® audio streaming
 - Bluetooth® mobile phone portal
 - Apple CarPlay™/Android Auto™
 - USB audio connection
- Six speakers

Interior convenience/styling:

- Air conditioning
- Sports-style heated front seats
- Leather-covered heated steering wheel
- Multi-function trip computer
- Cruise control
- Speed-sensitive power-assisted steering
- Steering column adjustable for reach/rake
- Steering wheel audio/phone/cruise controls
- Driver's seat height adjuster
- Front and rear floor mats (front Griffin-branded)

Exterior convenience/styling:

- Automatic lighting control
- Rain-sensitive windscreen wipers
- Roof/door mirrors/front grille bar in black
- Heated windscreen
- Remote control central locking
- Electrically operated front windows
- Dark-tinted rear windows
- Front fog lights
- 16-inch black alloy wheels

Safety/security:

- Electronic Stability Programme (ESP)
- Anti-lock Braking System (ABS)
- Six airbags
- Hill start assist
- Seatbelt reminders for all seats
- ISOFIX child seat fixings on outer rear seats
- Tyre pressure monitoring system
- LED daytime running lights

SPORT



SPORT ON-THE-ROAD PRICES

	3-door hatchback		5-door hatchback		Insurance Group
	OTR RRP	CO ₂ (g/km)	OTR RRP	CO ₂ (g/km)	
Petrol					
1.4i (75PS)	£15,805	128	£16,365	128	4E
1.4i (90PS) S/S	£16,295	124	£16,855	123	7E

Please note: On-the-road recommended retail prices (RRP) include VAT at 20%, number plates and delivery to Retailer of £700.00 (inc. £116.67 VAT), 12 months' Vehicle Excise Duty and new vehicle first registration fee of £55.00. Excludes fuel and insurance.

S/S = Start/Stop.

FEATURES

Infotainment:

- IntelliLink audio system
 - 7-inch colour touchscreen
 - AM/FM/DAB digital radio
 - Bluetooth® audio streaming
 - Bluetooth® mobile phone portal
 - Apple CarPlay™/Android Auto™
 - USB audio connection
- Six speakers

Interior convenience/styling:

- Air conditioning
- Leather-covered steering wheel
- Cruise control
- Steering column adjustable for reach/rake
- Steering wheel audio/phone/cruise controls
- Sports-style front seats
- Alloy-effect sports pedals
- Driver's seat height adjuster

Exterior convenience/styling:

- Heated windscreen
- Electrically adjustable/heated door mirrors
- Black B-pillars (with certain exterior colours)
- Dark-tinted rear windows
- 16-inch silver 4-twinspoke alloy wheels

Safety/security:

- Electronic Stability Programme (ESP)
- Anti-lock Braking System (ABS)
- Six airbags
- Hill start assist
- ISOFIX child seat fixings on outer rear seats
- Tyre pressure monitoring system
- Daytime running lights
- Engine deadlock immobiliser

SRI NAV



SRI NAV ON-THE-ROAD PRICES

	3-door hatchback		5-door hatchback		Insurance Group
	OTR RRP	CO ₂ (g/km)	OTR RRP	CO ₂ (g/km)	
Petrol					
1.4i (75PS)	£16,805	128	£17,365	128	4E
1.4i (90PS) S/S	£17,295	124	£17,855	123	8E
1.4i (90PS) automatic	-	-	£19,015	143	7E
1.4i Turbo (100PS) S/S	£17,915	125	£18,515	125	11E

Please note: On-the-road recommended retail prices (RRP) include VAT at 20%, number plates and delivery to Retailer of £700.00 (inc. £116.67 VAT), 12 months' Vehicle Excise Duty and new vehicle first registration fee of £55.00. Excludes fuel and insurance.

S/S = Start/Stop.

FEATURES

Infotainment:

- Navi 4.0 IntelliLink satellite navigation system
 - Fully integrated European satellite navigation system
 - 7-inch colour touchscreen
 - AM/FM/DAB digital radio
 - Bluetooth® audio streaming
 - Bluetooth® mobile phone portal
 - Apple CarPlay™/Android Auto™
 - USB audio connection
- Six speakers

Interior convenience/styling:

- Air conditioning
- Leather-covered steering wheel
- Cruise control
- Steering column adjustable for reach/rake
- Steering wheel audio/phone/cruise controls
- Sports-style front seats
- Driver's seat height adjuster

Exterior convenience/styling:

- Heated windscreen
- Rain-sensitive windscreen wipers
- Automatic lighting control
- Electrically adjustable/heated door mirrors
- Front fog lights with chrome-effect surround
- Black B-pillars (with certain exterior colours)
- 16-inch black 4-twinspoke alloy wheels (3-door)
 - no-cost option on 5-door models
- 16-inch silver 4-twinspoke alloy wheels (5-door)
 - no-cost option on 3-door models

Safety/security:

- Electronic Stability Programme (ESP)
- Anti-lock Braking System (ABS)
- Six airbags
- Hill start assist
- ISOFIX child seat fixings on outer rear seats
- Tyre pressure monitoring system
- Daytime running lights
- Engine deadlock immobiliser

SE NAV



SE NAV ON-THE-ROAD PRICES

	3-door hatchback		5-door hatchback		Insurance Group
	OTR RRP	CO ₂ (g/km)	OTR RRP	CO ₂ (g/km)	
Petrol					
1.4i (75PS)	-	-	£16,185	128	4E
1.4i (90PS) S/S	£16,125	124	£16,685	123	7E
1.4i (90PS) automatic	£17,235	136	£17,835	143	7E
1.4i Turbo (100PS) S/S	-	-	£17,335	125	11E

Please note: On-the-road recommended retail prices (RRP) include VAT at 20%, number plates and delivery to Retailer of £700.00 (inc. £116.67 VAT), 12 months' Vehicle Excise Duty and new vehicle first registration fee of £55.00. Excludes fuel and insurance.

S/S = Start/Stop.

FEATURES

Infotainment:

- Navi 4.0 IntelliLink satellite navigation system
 - Fully integrated European satellite navigation system
 - 7-inch colour touchscreen
 - AM/FM/DAB digital radio
 - Bluetooth® audio streaming
 - Bluetooth® mobile phone portal
 - Apple CarPlay™/Android Auto™
 - USB audio connection
- Six speakers

Interior convenience/styling:

- Air conditioning
- Auto anti-dazzle rear-view mirror
- Multi-function trip computer
- Heated leather-covered steering wheel
- Heated front seats
- 60/40 split-folding rear seat back
- Cruise control
- Speed-sensitive power-assisted steering
- Steering column adjustable for reach/rake
- Steering wheel audio/phone/cruise controls
- Driver's seat height adjuster

Exterior convenience/styling:

- Heated windscreen
- Remote control central locking
- Electrically operated front windows
- Auto lighting/windscreen wipers
- Electrically adjustable/heated door mirrors
- Body-colour exterior door handles
- Front/rear parking sensors
- Front fog lights
- Chrome-effect lower side window mouldings (5-door only)
- 16-inch multi-spoke alloy wheels

Safety/security:

- Electronic Stability Programme (ESP)
- Anti-lock Braking System (ABS)
- Six airbags
- Hill start assist
- Seatbelt reminders for all seats
- ISOFIX child seat fixings on outer rear seats
- Tyre pressure monitoring system
- Daytime running lights
- Engine deadlock immobiliser

SRI VX-LINE NAV BLACK



SRI VX-LINE NAV BLACK ON-THE-ROAD PRICES

	3-door hatchback		5-door hatchback		Insurance Group
	OTR RRP	CO ₂ (g/km)	OTR RRP	CO ₂ (g/km)	
Petrol					
1.4i (75PS)	£17,495	131	£18,055	130	4E
1.4i (90PS) S/S	£17,945	126	£18,545	125	8E
1.4 Turbo (100PS) S/S	£18,595	128	£19,195	128	12E

Please note: On-the-road recommended retail prices (RRP) include VAT at 20%, number plates and delivery to Retailer of £700.00 (inc. £116.67 VAT), 12 months' Vehicle Excise Duty and new vehicle first registration fee of £55.00. Excludes fuel and insurance.

S/S = Start/Stop.

FEATURES

Infotainment:

- Navi 4.0 IntelliLink satellite navigation system
 - Fully integrated European satellite navigation system
 - 7-inch colour touchscreen
 - AM/FM/DAB digital radio
 - Bluetooth® audio streaming
 - Bluetooth® mobile phone portal
 - Apple CarPlay™/Android Auto™
 - USB audio connection
- Six speakers

Interior convenience/styling:

- Air conditioning
- Sports-style front seats
- VX-Line styling: Leather-covered flat-bottom steering wheel/gear knob/handbrake lever
- Multi-function trip computer
- Cruise control
- Speed-sensitive power-assisted steering
- Steering column adjustable for reach/rake
- Steering wheel audio/phone/cruise controls
- Driver's seat height adjuster

Exterior convenience/styling:

- VX-Line body styling: Front lower spoiler/side sills/rear skirt/rear roof spoiler (3-door only)
- Roof/door mirrors/front grille bar in black
- Heated windscreen
- Remote control central locking
- Electrically operated front windows
- Electrically adjustable/heated door mirrors
- Dark-tinted rear windows
- Sports suspension
- Front fog lights
- 17-inch black alloy wheels

Safety/security:

- Electronic Stability Programme (ESP)
- Anti-lock Braking System (ABS)
- Six airbags
- Hill start assist
- Seatbelt reminders for all seats
- ISOFIX child seat fixings on outer rear seats
- Tyre pressure monitoring system
- LED daytime running lights

CORSA 3-DOOR HATCHBACK PRICES

	Price (£)	VAT (£)	Total (£)	On-the-road RRP (£)	BiK 20% (£)	CO ₂ (g/km)
ACTIVE						
1.4i (75PS)	9,008.33	1,801.67	10,810.00	11,735.00	55.62	128
DESIGN						
1.4i (75PS)	10,450.00	2,090.00	12,540.00	13,465.00	63.98	128
ENERGY						
1.4i (75PS)	11,583.33	2,316.67	13,900.00	14,825.00	70.55	128
1.4i (90PS) Start/Stop	12,000.00	2,400.00	14,400.00	15,325.00	70.45	124
1.4i (90PS) auto	12,891.67	2,578.33	15,470.00	16,435.00	83.53	136
GRIFFIN (SPECIAL EDITION MODEL)						
1.4i (75PS)						128
1.4i (90PS)						128
1.4i (90PS) Start/Stop						124
1.4i (90PS) auto						136
SPORT						
1.4i (75PS)	12,400.00	2,480.00	14,880.00	15,805.00	75.30	128
1.4i (90PS) Start/Stop	12,808.33	2,561.67	15,370.00	16,295.00	74.98	124

	Price (£)	VAT (£)	Total (£)	On-the-road RRP (£)	BiK 20% (£)	CO ₂ (g/km)
SRI NAV						
1.4i (75PS)	13,233.33	2,646.67	15,880.00	16,805.00	80.13	128
1.4i (90PS) Start/Stop	13,641.67	2,728.33	16,370.00	17,295.00	79.65	124
1.4i Turbo (100PS) Start/Stop	14,158.33	2,831.67	16,990.00	17,915.00	85.50	125
SE NAV						
1.4i (90PS) Start/Stop	12,666.67	2,533.33	15,200.00	16,125.00	74.18	124
1.4i (90PS) auto	13,558.33	2,711.67	16,270.00	17,235.00	87.67	136
SRI VX-LINE NAV BLACK						
1.4i (75PS)	13,775.00	2,755.00	16,530.00	17,495.00	86.13	131
1.4i (90PS) Start/Stop	14,183.33	2,836.67	17,020.00	17,945.00	85.63	126
1.4i Turbo (100PS) Start/Stop	14,725.00	2,945.00	17,670.00	18,595.00	88.78	128

Colours and model variants for Griffin special edition subject to availability. Please check with your Vauxhall Retailer.

Please note: On-the-road recommended retail prices (RRP) include number plates and delivery to retailer of £700.00 (inc. £116.67 VAT), 12 months' Vehicle Excise Duty and new vehicle first registration fee of £55.00. Excludes fuel and insurance. Company Car Benefit in Kind (BiK) rates are monthly based on the standard paint price.

CORSA 5-DOOR HATCHBACK PRICES

	Price (£)	VAT (£)	Total (£)	On-the-road RRP (£)	BiK 20% (£)	CO ₂ (g/km)
DESIGN						
1.4i (75PS)	10,916.67	2,183.33	13,100.00	14,025.00	66.68	128
1.4i (90PS) Start/Stop	11,325.00	2,265.00	13,590.00	14,515.00	66.68	123
1.4i (90PS) auto	12,258.33	2,451.67	14,710.00	15,675.00	82.18	143
ENERGY						
1.4i (75PS)	12,050.00	2,410.00	14,460.00	15,385.00	73.27	128
1.4i (90PS) Start/Stop	12,466.67	2,493.33	14,960.00	15,885.00	73.07	123
1.4i (90PS) auto	13,391.67	2,678.33	16,070.00	17,035.00	89.43	143
1.4i Turbo (100PS) Start/Stop	12,766.67	2,553.33	15,320.00	16,245.00	77.42	125
GRIFFIN (SPECIAL EDITION MODEL)						
1.4i (75PS)						128
1.4i (90PS)	PRICE AVAILABLE ON REQUEST FROM RETAILER					128
1.4i (90PS) Start/Stop						123
1.4i (90PS) auto						143
SPORT						
1.4i (75PS)	12,866.67	2,573.33	15,440.00	16,365.00	78.00	128
1.4i (90PS) Start/Stop	13,275.00	2,655.00	15,930.00	16,855.00	77.60	123

	Price (£)	VAT (£)	Total (£)	On-the-road RRP (£)	BiK 20% (£)	CO ₂ (g/km)
SRI NAV						
1.4i (75PS)	13,700.00	2,740.00	16,440.00	17,365.00	82.83	128
1.4i (90PS) Start/Stop	14,108.33	2,821.67	16,930.00	17,855.00	82.27	123
1.4i (90PS) auto	15,041.67	3,008.33	18,050.00	19,015.00	99.98	143
1.4i Turbo (100PS) Start/Stop	14,658.33	2,931.67	17,590.00	18,515.00	88.40	125
SE NAV						
1.4i (75PS)	12,716.67	2,543.33	15,260.00	16,185.00	77.13	128
1.4i (90PS) Start/Stop	13,133.33	2,626.67	15,760.00	16,685.00	76.80	123
1.4i (90PS) auto	14,058.33	2,811.67	16,870.00	17,835.00	93.70	143
1.4i Turbo (100PS) Start/Stop	13,675.00	2,735.00	16,410.00	17,335.00	82.68	125
SRI VX-LINE NAV BLACK						
1.4i (75PS)	14,275.00	2,855.00	17,130.00	18,055.00	89.13	130
1.4i (90PS) Start/Stop	14,683.33	2,936.67	17,620.00	18,545.00	88.53	125
1.4i Turbo (100PS) Start/Stop	15,225.00	3,045.00	18,270.00	19,195.00	91.68	128

Colours and model variants for Griffin special edition subject to availability. Please check with your Vauxhall Retailer.

Please note: On-the-road recommended retail prices (RRP) include number plates and delivery to retailer of £700.00 (inc. £116.67 VAT), 12 months' Vehicle Excise Duty and new vehicle first registration fee of £55.00. Excludes fuel and insurance. Company Car Benefit in Kind (BiK) rates are monthly based on the standard paint price.

STANDARD FEATURES

ALL MODELS

Driver/passenger airbags

- Driver's dual-stage airbag • Front passenger's dual-stage airbag
 - Front seat side-impact airbags • Full-size curtain airbags
-

Seating

- Reach and rake adjustable steering • Height-adjustable front seat head restraints
 - Adjustable outer rear seat head restraints
 - Anti-submarining ramps in all seats – Helps prevent occupants sliding underneath the lap belt during a collision.
-

Seatbelts

- Height-adjustable front seatbelts • Three inertia-reel lap and diagonal rear seatbelts
 - Front seatbelt pretensioner system – Pretensioners tighten the seatbelt in the event of an accident limiting forward movement.
 - Front seatbelt force limiters – Reduces potential upper body injuries during a frontal impact.
 - Front and rear 'seatbelt unfastened' audible warning and warning light
-

Child safety

- Deactivation switch for front passenger's airbag – Permits the safe use of a child seat in the front passenger seat.
 - ISOFIX child seat mountings incorporating top tether anchor points located on outer rear seats (does not include child seat) – Allows ISOFIX child safety seats to be securely fixed into the car. The ISOFIX mounting system reduces forward movement in an accident and makes the child seat easier to install.
 - Child-proof locks on rear doors
-

Driver/passenger safety

- Energy-absorbing steering column
 - Pedal release system – Reduces potential injury to the driver's legs and feet during a severe frontal impact.
 - Laminated windscreen • Side-impact protection beams • Reinforced passenger safety cell
-

Pedestrian safety

- Bonnet/headlight/wiper structure – Designed to reduce pedestrian head and upper body injuries.
 - Upper and lower bumper design – Reduces upper and lower leg injuries.
-

Stability

- Electronic Stability Programme (ESP) – Works in conjunction with the vehicle's electronic braking and engine systems to keep the car stable in many different situations. ESP monitors many different inputs to determine when the car starts to lose traction, it can then immediately respond by varying the brake pressure between up to three wheels and adjust the engine output to help correct the loss of traction and improve stability.

Additional ESP features:

- Traction control • Cornering brake control • Straight line stability control
 - Drag torque control – Maintain stability on slippery roads when lifting off the accelerator or changing gear.
-

Braking

- Anti-lock Braking System (ABS) – Prevents the vehicle's wheels from locking up under heavy braking by momentarily reducing brake pressure at the appropriate wheel, ensuring that you can maintain control of the steering.

Additional ESP features:

The same electronic systems used in the ABS and ESP also deliver exceptional braking performance.

- Emergency brake assist – When emergency braking is detected the vehicle automatically applies the maximum possible braking assistance.
 - Electronic brakeforce distribution – Automatically apportions the optimum braking force to each wheel.
 - Adaptive brake lights – Automatically warns other road users of heavy braking
 - Hill start assist – Briefly maintains rear brake pressure to stop the vehicle rolling back on an incline.
 - Hazard warning lights
-

Tyre pressure

- Deflation detection system
-

Steering

- Speed-sensitive electric power-assisted steering
 - City mode button – Provides lighter steering at parking speeds.
-

Cruise control with speed limiter

Enables you to maintain a constant speed – making it ideal for economical motorway driving.

- The speed limiter function – Can be set to ensure that you do not exceed the speed limit and can be easily overridden if required.
 - Steering wheel mounted controls
-

STANDARD FEATURES

ALL MODELS

Standard security features

- ‘Key left in ignition’ audible warning
 - Electronically protected audio equipment
 - Engine deadlock immobiliser
 - Visible Vehicle Identification Number (VIN)
 - Locking wheel bolts for alloy wheels (where fitted)
 - Door-to-door illumination
-

Central locking

- Remote control
 - Operates on doors, tailgate and fuel filler flap
 - Deadlocking
 - Central locking activation switch on facia
 - One folding key/one static key each with integral remote control function
-

Instrumentation

- Speedometer
 - Rev counter
 - Digital fuel gauge with low fuel level warning light
 - Digital water temperature gauge
 - Instrument panel light dimmer
 - Shift-up indication light – Indicates when to change gear for optimum fuel economy
-

Driver information display (centrally located in instrument cluster)

- Displays trip computer data
 - Total mileage
 - Service-due indicator
 - Oil life
 - Tyre pressure monitoring system
 - Headlight/brake light bulb failure warning
-

Central facia display (format dependent on infotainment unit)

- Audio information
 - Digital clock with automatic RDS time adjustment
 - Outside air temperature with ice warning function
 - Additional features dependent on infotainment unit (see infotainment for details)
-

Audio features

- Six speakers
 - Steering wheel mounted audio controls
-

Heating and ventilation

- Four adjustable facia vents
 - Windscreen demist vents
 - Side window demist vents
-

Rear seats

- Three-person layout
 - Adjustable backrest
 - Height-adjustable and removable outer head restraints
-

Convenience features

- Front 12-volt electrical accessory socket
 - Driver’s and front passengers sunvisors
 - Passenger’s vanity mirror
 - Dipping rear-view mirror
 - Driver’s and front passenger’s tiltable assist handles
 - Two rear tiltable passenger assist handles (five-door models only)
-

Interior lighting

- Central front courtesy light
 - Central rear courtesy light
 - Fade up/fade down
 - Front map reading lights
 - Rear reading light (five-door models only)
-

Interior storage

- Storage box on driver’s side lower facia
 - Glovebox with lid
 - Front door pockets
 - Drinks holder in centre console
 - Rear door pockets (five-door models only)
 - Rear bottle holders (three-door models only)
-

Luggage area

- Luggage compartment cover
 - Stowage facility for luggage compartment cover behind rear seats
 - Illuminated luggage area
 - Interior tailgate handles
 - Load restraint lashing eyes
 - Twin gas-assisted tailgate struts
-

Standard lighting features

- Halogen headlights
 - Welcome lighting
 - Lights-on audible warning
 - Electric headlight beam levelling
 - High-level LED centre rear brake light
 - Rear fog light
 - Reversing light
 - Hazard warning lights
-

Windscreen wipers

- Two-speed windscreen wipers with variable intermittent wipe
 - Intermittent rear window wash/wipe
-

Body styling

- Body-colour door handles
-

Windows

- Heated windscreen
 - Tinted windows
 - Heated rear window
 - Electrically operated front windows with safety autoreverse and one-touch facility
-

FEATURES/OPTIONS

DRIVER ASSISTANCE

	Active	Design	Energy	Griffin	Sport	SRi Nav	SE Nav	SRi VX-Line Nav Black	Price (£) exc. VAT	Price (£) inc. VAT
Parking sensors • Rear parking distance sensors • Audible warning	○	○	○		○	○	●	○	250.00	300.00
• Front and rear parking distance sensors • Audible warning • Distance warning graphic shown in driver information display	○	○	○		○	○	●	○	387.50	465.00
Rear-view camera The rear-view camera gives a clear view of the area behind your car and helps place the car perfectly, without needing to strain your neck. • Activated when reverse gear selected • Camera view appears in infotainment screen • Rear bumper and one-metre grid lines shown as reference points Please note: Only available in conjunction with parking sensors. Not available with CD 30 BT audio unit.		○	○		○	○	○	○	208.33	250.00

SECURITY

Security alarm system - 1.4i Turbo (100PS) models only. • Remote control (operates in conjunction with central locking) • Tilt sensor • Thatcham approved						○	○		216.67	260.00
---	--	--	--	--	--	---	---	--	--------	--------

DRIVER INFORMATION

Driver information display (centrally located in instrument cluster) Red graphics on black background	●									
Red graphics on black background (fitted in lieu of white graphics on 1.4i (75PS) and 1.4i (90PS) models if CD 30 BT audio unit is fitted in lieu of IntelliLink. Where digital speedometer and digital over-speed warning are standard, these features will be deleted. Not available separately).		●	●	●	●	●		●		
White graphics on black background		●	●	●	●	●	●	●		
Multi-function trip computer (displayed on driver information display) • Trip mileage • Vehicle range based on remaining fuel • Average speed • Average fuel economy • Instantaneous fuel economy • Digital speedometer • Digital over-speed warning				●	●	●	●	●		

● = Standard equipment. ○ = Optional at extra cost.

FEATURES/OPTIONS

INTERIOR STYLING

	Active	Design	Energy	Griffin	Sport	SRi Nav	SE Nav	SRi VX-Line Nav Black	Price (£) exc. VAT	Price (£) inc. VAT
<p>Active interior décor</p> <p>Steering wheel:</p> <ul style="list-style-type: none"> • Three-spoke design • Leather-covered • Satin chrome-effect bezel <p>Facia and door trim:</p> <ul style="list-style-type: none"> • Piano black facia • Black door panels with black Atlantis cloth inserts • Chrome-effect interior door handles <p>Seat trim:</p> <ul style="list-style-type: none"> • Spot Shimmer black fabric seat trim inserts • Plain black fabric side bolsters and surrounds 	●									
<p>Design/Energy/SE Nav interior décor</p> <p>Steering wheel:</p> <ul style="list-style-type: none"> • Three-spoke design • Leather-covered • Satin chrome-effect bezel <p>Facia and door trim:</p> <ul style="list-style-type: none"> • Rhutenium facia with chrome-effect trim inserts • Black door panels with black Atlantis cloth inserts • Chrome-effect interior door handles <p>Seat trim:</p> <ul style="list-style-type: none"> • Spot Shimmer black fabric seat trim inserts • Plain black fabric side bolsters and surrounds 		●	●				●			
<p>Griffin interior décor</p> <p>Steering wheel:</p> <ul style="list-style-type: none"> • Three-spoke design • Leather-covered with accent stitching • Satin chrome-effect bezel <p>Facia and door trim:</p> <ul style="list-style-type: none"> • Piano black facia with red/white inserts (dependent on exterior colour) • Black door panels with black Atlantis cloth inserts • Chrome-effect interior door handles <p>Seat trim:</p> <ul style="list-style-type: none"> • Black lace fabric seat trim inserts • Plain black fabric side bolsters and surrounds with accent stitching 				●						

● = Standard equipment.

FEATURES/OPTIONS

INTERIOR STYLING CONTINUED

	Active	Design	Energy	Griffin	Sport	SRI Nav	SE Nav	SRI VX-Line Nav Black	Price (£) exc. VAT	Price (£) inc. VAT
<p>Sport interior décor</p> <p>Steering wheel:</p> <ul style="list-style-type: none"> • Three-spoke design • Leather-covered • Satin chrome-effect bezel <p>Facia and door trim:</p> <ul style="list-style-type: none"> • Piano black facia with red/white inserts (dependent on exterior colour) • Black door panels with black Atlantis cloth inserts • Chrome-effect interior door handles <p>Seat trim:</p> <ul style="list-style-type: none"> • Black Lace fabric seat trim inserts • Plain black fabric side bolsters and surrounds with accent stitching 					●					
<p>SRI Nav interior décor</p> <p>Steering wheel:</p> <ul style="list-style-type: none"> • Three-spoke design • Leather-covered with accent stitching • Satin chrome-effect bezel <p>Facia and door trim:</p> <ul style="list-style-type: none"> • Piano black facia with red trim inserts (except Aegean Blue models, which feature a white trim insert) • Black door panels with black Atlantis cloth inserts • Chrome-effect interior door handles <p>Seat trim:</p> <ul style="list-style-type: none"> • Black lace fabric seat trim inserts • Plain black fabric side bolsters and surrounds with accent stitching 						●				
<p>SRI VX-Line Nav Black interior décor</p> <p>Steering wheel:</p> <ul style="list-style-type: none"> • VX-Line three-spoke design • Leather-covered flat bottom • Satin chrome-effect bezel <p>Gear knob:</p> <ul style="list-style-type: none"> • VX-Line leather-covered <p>Facia and door trim:</p> <ul style="list-style-type: none"> • Piano black facia with white trim inserts • Black door panels with black Atlantis cloth inserts • Chrome-effect interior door handles <p>Seat trim:</p> <ul style="list-style-type: none"> • Black Lace fabric seat trim inserts • Plain black fabric side bolsters and surrounds with accent stitching 								●		
<p>Seat trim:</p> <ul style="list-style-type: none"> • Network Moonray cloth seat trim inserts • Piano black facia side bolsters and surrounds 								○	133.33	160.00

● = Standard equipment. ○ = Optional at extra cost.

FEATURES/OPTIONS

INFOTAINMENT

	Active	Design	Energy	Griffin	Sport	SRi Nav	SE Nav	SRi VX-Line Nav Black	Price (£) exc. VAT	Price (£) inc. VAT
<p>CD 30 BT</p> <p>Onboard features:</p> <ul style="list-style-type: none"> • CD/MP3 CD player • AM/FM stereo radio with 36 station presets • RDS with Traffic Programme <p>Media connections:</p> <ul style="list-style-type: none"> • USB connection with iPod control • Aux-in socket <p>Mobile phone portal:</p> <ul style="list-style-type: none"> • Bluetooth® connectivity • Handsfree calls via steering wheel controls • Vehicle microphone • Phone book access <p>Please note: On 1.4i (75PS) and 1.4i (90PS) models the trip computer including digital speedometer and digital over-speed warning are deleted.</p>	●	N/C	N/C		N/C	N/C	N/C	N/C	No-cost option	
<p>R4.0 IntelliLink touchscreen infotainment system</p> <p>For use with media players, USB memory sticks, mobile phones and smartphone apps.</p> <p>Onboard features:</p> <ul style="list-style-type: none"> • 7-inch colour touchscreen • DAB digital radio/AM/FM stereo radio with 36 station presets • RDS with Traffic Programme <p>Media connections:</p> <ul style="list-style-type: none"> • USB connection with iPod control • Bluetooth® A2DP audio streaming (Advanced Audio Distribution Profile) <p>Mobile phone portal:</p> <ul style="list-style-type: none"> • Bluetooth® connectivity • Handsfree calls via steering wheel controls • Vehicle microphone • Phone book access – The majority of the phone’s functions – contacts/last calls/missed calls etc. – are mirrored on IntelliLink’s display and are easily navigated using the touchscreen (features dependent on mobile phone). <p>Smartphone interface:</p> <ul style="list-style-type: none"> • Apple CarPlay™ • Android Auto™ – Smartphone projection that allows operations via voice command, touchscreen and buttons to control apps and music playback. 		●	●		●					

● = Standard equipment. N/C = No-cost option. Please note, removes R4.0 or Navi 4.0 IntelliLink system where specified.

FEATURES/OPTIONS

INFOTAINMENT CONTINUED

	Active	Design	Energy	Griffin	Sport	SRi Nav	SE Nav	SRi VX-Line Nav Black	Price (£) exc. VAT	Price (£) inc. VAT
<p>Navi 4.0 IntelliLink touchscreen navigation and infotainment system For use with media players, USB memory sticks, mobile phones and smartphone apps</p> <p>Onboard features: • 7-inch colour touchscreen • DAB digital radio/AM/FM stereo radio with 36 station presets • RDS with Traffic Programme</p> <p>Navigation features: • Satellite navigation system • 2D street level mapping • European coverage • Structured or one-box destination entry • Points-of-interest search • Eco routing • Map updates via USB</p> <p>Media connections: • USB connection with iPod control • Bluetooth® A2DP audio streaming (Advanced Audio Distribution Profile)</p> <p>Mobile phone portal: • Bluetooth® connectivity • Handsfree calls via steering wheel controls • Vehicle microphone • Phone book access – The majority of the phone’s functions – contacts/last calls/missed calls etc. – are mirrored on IntelliLink’s display and are easily navigated using the touchscreen (features dependent on mobile phone).</p> <p>Smartphone interface: • Apple CarPlay™ • Android Auto™ – Smartphone projection that allows operations via voice command, touchscreen and buttons to control apps and music playback.</p> <p>Gallery – only available when vehicle is stationary: • Photo gallery with slide show feature • Video playback with soundtrack played through car speakers</p>		○	○	●	○	●	●	●	541.67	650.00

● = Standard equipment. ○ = Optional at extra cost.

FEATURES/OPTIONS

HEATING AND VENTILATION

	Active	Design	Energy	Griffin	Sport	SRi Nav	SE Nav	SRi VX-Line Nav Black	Price (£) exc. VAT	Price (£) inc. VAT
Air blend heater • Cabin particulate filter – Removes dust, airborne particles and pollen • Four-speed fan • Illuminated controls	●									
Air conditioning • Air recirculation facility • Cabin particulate filter – Removes dust, airborne particles and pollen • Four-speed fan • Illuminated controls		●	●	●	●	●	●	●		
Electronic climate control incorporating air conditioning • Single-zone control • Advanced predictive logic control system using sun sensor • Cabin charcoal filter – Removes dust, airborne particles, pollen and unpleasant odours • Automatic air direction and fan speed with manual override • LCD temperature display • Six-speed fan • Illuminated controls			○		○	○	○	○	345.83	415.00

SEATING AND COMFORT

Comfort front seats Driver's seat (eight-way adjustable): • Height (up/down) • Reach (fore/aft) • Backrest (upright/recline) • Head restraint (up/down) Front passenger's seat (six-way adjustable): • Reach (fore/aft) • Backrest (upright/recline) • Head restraint (up/down)	●	●	●				●			
Sports-style front seats Driver's seat (eight-way adjustable): • Height (up/down) • Reach (fore/aft) • Backrest (upright/recline) • Head restraint (up/down) Front passenger's seat (six-way adjustable): • Reach (fore/aft) • Backrest (upright/recline) • Head restraint (up/down)				●	●	●		●		
Front passenger's seat height adjuster	○	○	○		○	○	○	○	62.50	75.00
• One-piece folding rear seat	●	●	●	●	●	●		●		
• 60/40 split-folding rear seat back	○	○	○		○	○	●	○	116.67	140.00

● = Standard equipment. ○ = Optional at extra cost.

FEATURES/OPTIONS

INTERIOR CONVENIENCE

	Active	Design	Energy	Griffin	Sport	SRi Nav	SE Nav	SRi VX-Line Nav Black	Price (£) exc. VAT	Price (£) inc. VAT
Automatically dimming anti-dazzle rear-view mirror		☐	●	●	☐	●	●			
Front and rear floor mats (front Griffin-branded)				●						

EXTERIOR LIGHTING

Bi-xenon headlights with cornering light							○	○	354.17	425.00
Daytime running lights	●	●	●		●	●	●			
LED daytime running lights				●				●		
Front fog lights with black surround		●	●	●			●	●		
Front fog lights with chrome-effect surround						●				

EXTERIOR CONVENIENCE

Windscreen wipers • Rain-sensitive windscreen wipers		☐	●	●	☐	●	●			
Door mirrors • Electrically adjustable door mirrors (wide-angle on driver's side), manually foldable	●	●		●						
• Electrically adjustable/heated door mirrors (wide-angle on driver's side), manually foldable			●		●	●	●	●		

● = Standard equipment. ○ = Optional at extra cost. ☐ = Available as part of an extra-cost option pack.

FEATURES/OPTIONS

EXTERIOR STYLING

	Active	Design	Energy	Griffin	Sport	SRi Nav	SE Nav	SRi VX-Line Nav Black	Price (£) exc. VAT	Price (£) inc. VAT
Black foil on B-pillars (not with Aegean Blue or optional Mineral Black or Darkmoon Blue exterior colours)	●	●	●	●	●	●	●	●		
Active/Design/Energy/Sport/SRi Nav styling • Chrome-effect front grille bar • Body-colour door mirrors • Body-colour door handles	●	●	●		●	●				
Griffin styling • Mineral Black door mirror housings • Black front grille bar • Body-colour door handles • Mineral Black roof				●						
Griffin styling • Body-colour door mirror housings • Black front grille bar • Body-colour door handles • Body-colour roof				N/C						
SE Nav styling • Chrome-effect front grille bar • Body-colour door mirrors • Body-colour door handles • Chrome-effect lower side window mouldings (5-door models only)							●			
SRi VX-Line Nav Black styling • Mineral Black door mirror housings • Black front grille bar • Body-colour door handles • Body-colour front lower spoiler/side sills/rear lower skirt • Rear roof spoiler (3-door models only) • Mineral Black roof								●		
Windows • Dark-tinted rear windows		○	○	●	●	○	○	●	237.50	285.00

OPTION PACKS

Sight and Light Pack • Rain-sensitive windscreen wipers • Automatic lighting control • Automatically dimming anti-dazzle rear-view mirror		○	●	●	○	●	●		200.00	240.00
Winter Pack • Heated leather-covered steering wheel • Heated front seats		○	●	●	○	○	●	○	303.17	365.00

● = Standard equipment. ○ = Optional at extra cost. N/C = No-cost alternative with limited availability.

EXTERIOR COLOURS





			Active	Design	Energy	Griffin	Sport	SRi Nav	SE Nav	SRi VX-Line Nav Black	Price (£) exc. VAT	Price (£) inc. VAT
Solid		Aegean Blue • Not available with Network Moonray cloth trim	●	●	●	●	●	●	●	●		
Brilliant		Lava Red	○	○	○	○	○	○	○	○	245.83	295.00
		Summit White	○	○	○	○	○	○	○	○		

The colours reproduced may vary slightly from the actual paint colour. As a result they should be used as a guide only. Your Vauxhall Retailer has a comprehensive display of our paint samples.

Colours and model variants for Griffin special edition subject to availability. Please check with your Vauxhall Retailer.

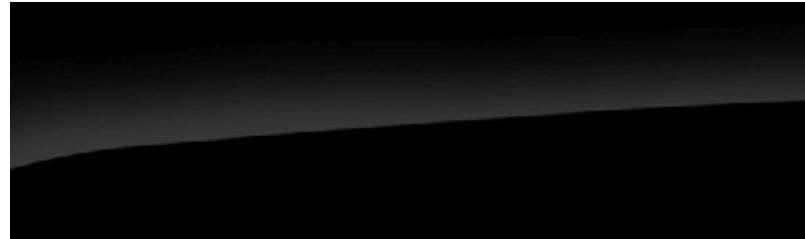
● = Standard equipment. ○ = Optional at extra cost.

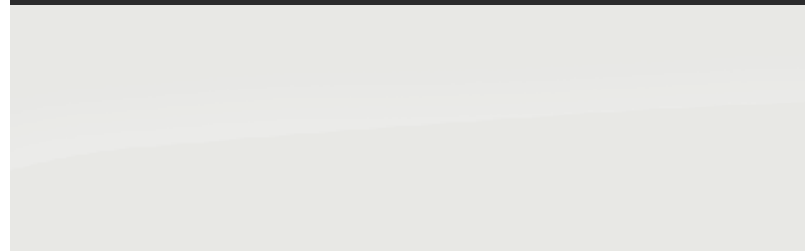
EXTERIOR COLOURS



		Active	Design	Energy	Griffin	Sport	SRi Nav	SE Nav	SRi VX-Line Nav Black	Price (£) exc. VAT	Price (£) inc. VAT
Two-coat		<input type="checkbox"/>	<input type="checkbox"/>	<input type="checkbox"/>	<input type="checkbox"/>	<input type="checkbox"/>	<input type="checkbox"/>	<input type="checkbox"/>	<input type="checkbox"/>	470.83	565.00
		<input type="checkbox"/>	<input type="checkbox"/>	<input type="checkbox"/>	<input type="checkbox"/>	<input type="checkbox"/>	<input type="checkbox"/>	<input type="checkbox"/>	<input type="checkbox"/>		
		<input type="checkbox"/>	<input type="checkbox"/>	<input type="checkbox"/>	<input type="checkbox"/>	<input type="checkbox"/>	<input type="checkbox"/>	<input type="checkbox"/>	<input type="checkbox"/>		
		<input type="checkbox"/>	<input type="checkbox"/>	<input type="checkbox"/>	<input type="checkbox"/>	<input type="checkbox"/>	<input type="checkbox"/>	<input type="checkbox"/>	<input type="checkbox"/>	545.83	655.00
		<input type="checkbox"/>	<input type="checkbox"/>	<input type="checkbox"/>	<input type="checkbox"/>	<input type="checkbox"/>	<input type="checkbox"/>	<input type="checkbox"/>	<input type="checkbox"/>		

The colours reproduced may vary slightly from the actual paint colour. As a result they should be used as a guide only. Your Vauxhall Retailer has a comprehensive display of our paint samples.

Colours and model variants for Griffin special edition subject to availability. Please check with your Vauxhall Retailer.





○ = Optional at extra cost.

WHEELS AND TYRES

	Active	Design	Energy	Griffin	Sport	SRi Nav	SE Nav	SRi VX-Line Nav Black	Price (£) exc. VAT	Price (£) inc. VAT
Steel emergency spare wheel (in lieu of emergency tyre inflation kit)			○		○	○	○		91.67	110.00
Full-size steel spare wheel (in lieu of emergency tyre inflation kit)	○	○							91.67	110.00
 15-inch structure steel wheels with styled covers <ul style="list-style-type: none"> • 185/65 R 15 tyres • Emergency tyre inflation kit (in lieu of spare wheel) 		●								
 15-inch alloy wheels <ul style="list-style-type: none"> • 185/65 R 15 tyres • Emergency tyre inflation kit (in lieu of spare wheel) 	●	○						166.67	200.00	
 16-inch silver 4-twinspoke alloy wheels <ul style="list-style-type: none"> • 195/55 R 16 tyres • Emergency tyre inflation kit (in lieu of spare wheel) • Standard on SRi Nav 5-door models, no-cost option on SRi Nav 3-door models 			●		●	●				

● = Standard equipment. ○ = Optional at extra cost.

WHEELS AND TYRES

	Active	Design	Energy	Griffin	Sport	SRi Nav	SE Nav	SRi VX-Line Nav Black	Price (£) exc. VAT	Price (£) inc. VAT
 <p>16-inch black 4-twinspoke alloy wheels</p> <ul style="list-style-type: none"> • 195/55 R 16 tyres • Emergency tyre inflation kit (in lieu of spare wheel) • Standard on SRi Nav 3-door models, no-cost option on SRi Nav 5-door models 				●		●				
 <p>16-inch alloy wheels</p> <ul style="list-style-type: none"> • 195/55 R 16 tyres • Emergency tyre inflation kit (in lieu of spare wheel) 							●			
 <p>17-inch silver alloy wheels</p> <ul style="list-style-type: none"> • 215/45 R 17 tyre • Emergency tyre inflation kit (in lieu of spare wheel) 			○						341.67	410.00
 <p>17-inch Gloss black alloy wheels</p> <ul style="list-style-type: none"> • 215/45 R 17 tyres • Emergency tyre inflation kit (in lieu of spare wheel) 								●		

● = Standard equipment. ○ = Optional at extra cost.

PERFORMANCE, FUEL ECONOMY AND EMISSIONS

	Performance (manufacturer's figures)			Fuel economy mpg (litres/100km) [#]		CO ₂ emissions g/km [*]	Vehicle Excise Duty ^{**}		Benefit in kind company car taxation rates - 2018/19 tax year
	Wheel size (inches)	Maximum speed (mph)	Acceleration 0-62mph (sec)	Combined Low	Combined High		First year rate	Standard rate	
Petrol models									
1.4i (75PS)	15/16	101	15.5	42.2 (6.7)	44.1 (6.4)	128	£170	£145	29%
1.4i (75PS) 3-door	17	101	15.5	42.2 (6.7)	44.1 (6.4)	131	£210	£145	30%
1.4i (75PS) 5-door	17	101	15.5	42.2 (6.7)	44.1 (6.4)	130	£170	£145	30%
1.4i (90PS)	16	109	13.2	41.5 (6.8)	44.1 (6.4)	128	£170	£145	29%
1.4i (90PS) Start/Stop 3-door	15/16	109	13.2	41.5 (6.8)	44.8 (6.3)	124	£170	£145	28%
1.4i (90PS) Start/Stop 5-door	15/16	109	13.2	41.5 (6.8)	44.8 (6.3)	123	£170	£145	28%
1.4i (90PS) Start/Stop 3-door	17	109	13.2	41.5 (6.8)	44.8 (6.3)	126	£170	£145	29%
1.4i (90PS) Start/Stop 5-door	17	109	13.2	41.5 (6.8)	44.8 (6.3)	125	£170	£145	29%
1.4i Turbo (100PS) Start/Stop	16	115	11.0	42.8 (6.6)	44.1 (6.4)	125	£170	£145	29%
1.4i Turbo (100PS) Start/Stop	17	115	11.0	42.8 (6.6)	44.1 (6.4)	128	£170	£145	29%
1.4i (90PS) automatic 3-door	15/16	106	13.9	37.7 (7.5)	40.9 (6.9)	136	£210	£145	31%
1.4i (90PS) automatic 5-door	15/16	106	13.9	37.7 (7.5)	40.9 (6.9)	143	£210	£145	32%
1.4i (90PS) automatic 3-door	17	106	13.9	37.7 (7.5)	40.9 (6.9)	142	£210	£145	32%
1.4i (90PS) automatic 5-door	17	106	13.9	37.7 (7.5)	40.9 (6.9)	150	£210	£145	34%

[#]Fuel consumption figures are determined according to the WLTP test cycle. Full data relating to WLTP test cycles can be found at: www.vauxhall.co.uk/wltp

^{*}CO₂ emissions figures are determined according to the WLTP test cycle however, a Government formula is then applied to translate these figures back to what they would have been under the outgoing NEDC test cycle, which WLTP replaces. The correct tax treatment is then applied.

Figures are intended for comparability purposes only. The fuel consumption you achieve under real life driving conditions and CO₂ produced will depend upon a number of factors, including the accessories fitted after registration, variations in driving styles, weather conditions and vehicle load. Only compare fuel consumption and CO₂ with other vehicles tested using the same technical procedures. For more information contact your local Vauxhall Retailer.

^{**}Correct at time of publication.

DIMENSIONS

Loadspace Dimensions	3-door	5-door
Maximum length (seats up)	705 (27.8)	705 (27.8)
Maximum length*	1372 (54.0)	1372 (54.0)
Maximum width	944 (37.2)	944 (37.2)
Maximum height	843 (33.2)	876 (34.5)
Luggage Capacities* litres (cu.ft.)		
Rear seat up	280 (9.9)	285 (10.0)
Rear seat down (to glassline)	750 (26.5)	710 (25.1)
Rear seat down (to roof)	1090 (38.5)	1120 (39.5)

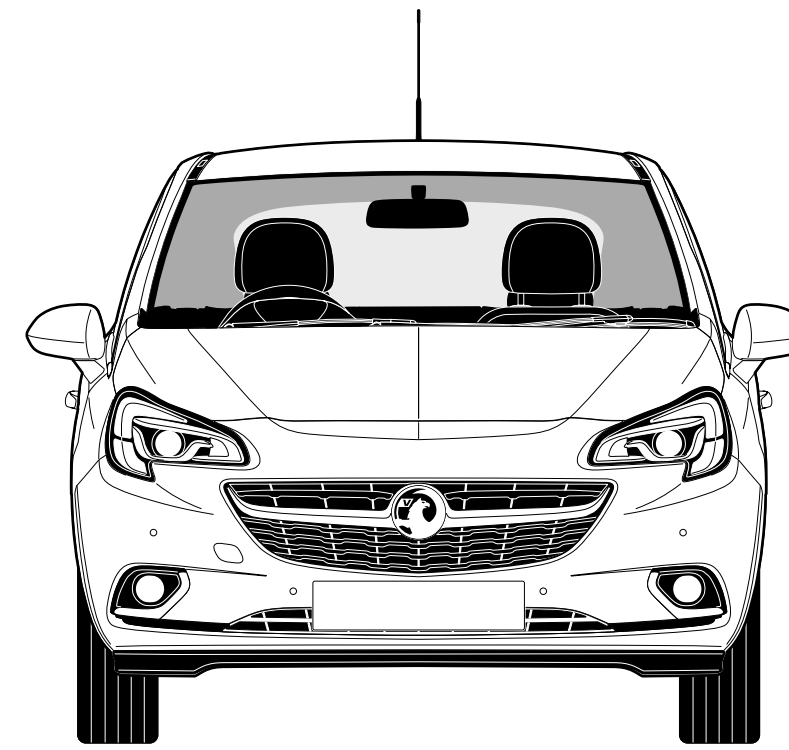

1736 (68.3)
excluding door mirrors

1944 (76.5)
including door mirrors

1479
(58.2)

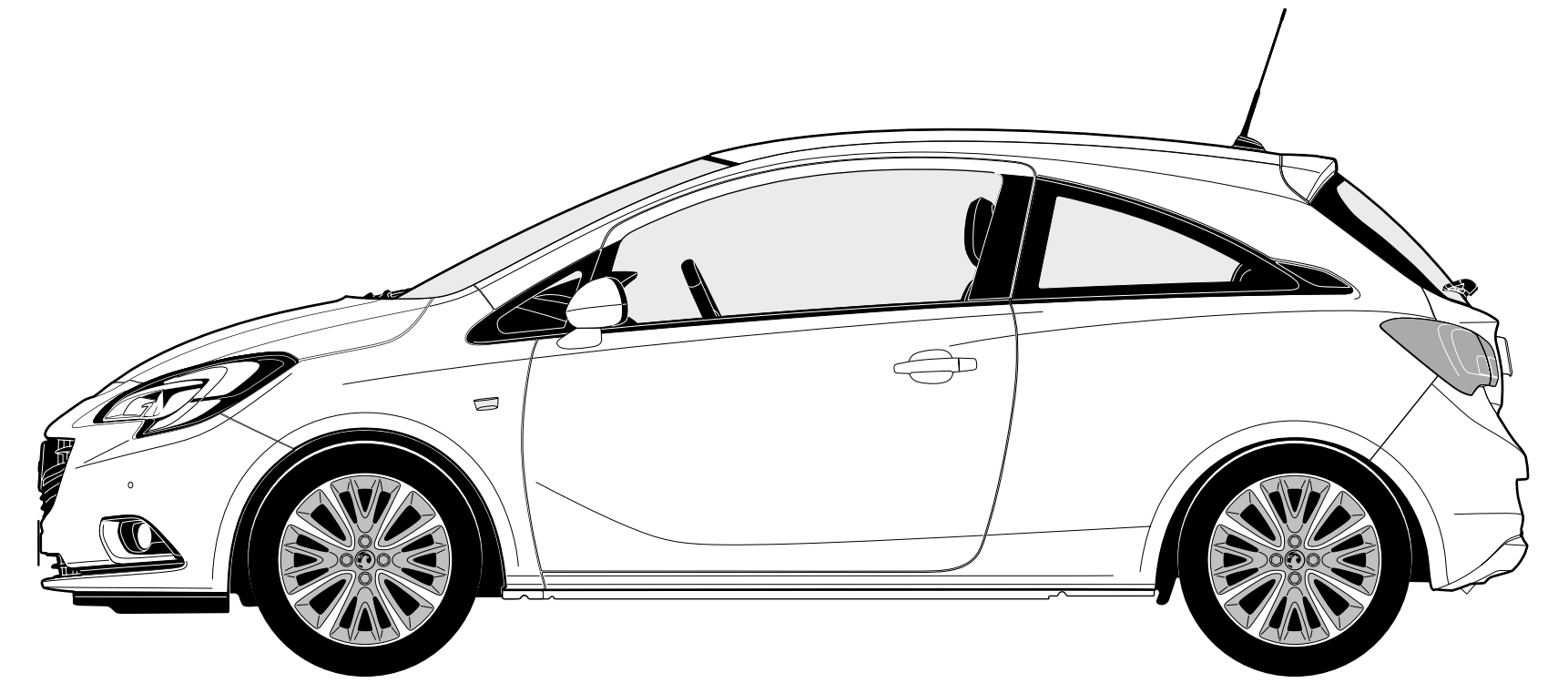

3-DOOR

881 (34.6) 2510 (98.8) 630 (24.9)

4021 (158.3)

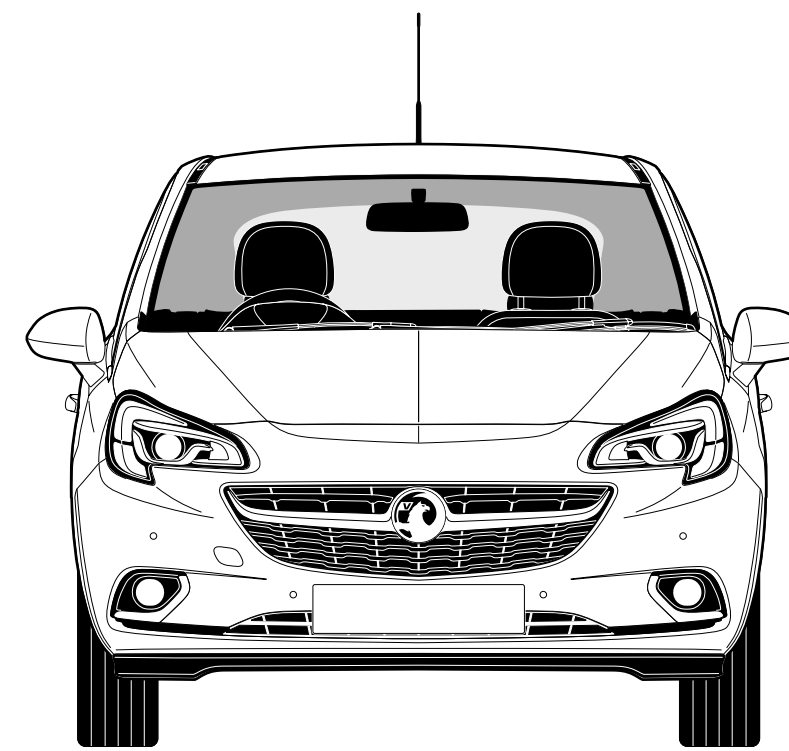

1746 (68.7)
excluding door mirrors

1944 (76.5)
including door mirrors

1481
(58.3)

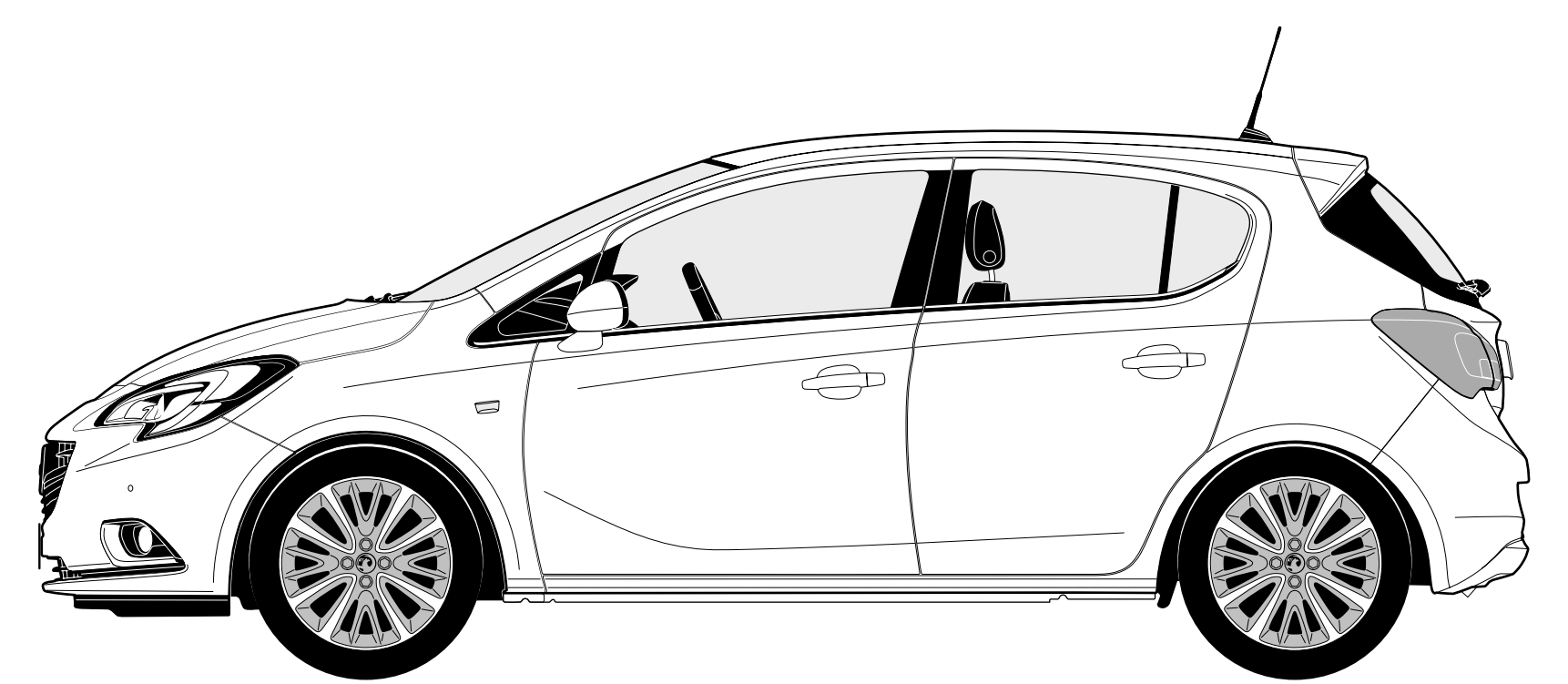

5-DOOR

881 (34.6) 2510 (98.8) 630 (24.9)

4021 (158.3)

All measurements are in mm (inches) unless stated otherwise.

*Behind front seats.

**Measured using the ECIE method.

SPECIFICATIONS

Transmission

Five-speed manual gearbox:
1.4i (75PS), 1.4i (90PS) models

Six-speed manual gearbox:
1.4i Turbo (100PS) models

Six-speed automatic transmission with Active Select function:

Available at extra cost on certain 1.4i (90PS) models. Electronically controlled with adaptive driving function and fuel-saving eco mode. Fluid drive with torque converter, lock-up clutch and Active Select.

Suspension

Front: Independent. Lightweight MacPherson struts with gas-pressure dampers and coil springs.

Anti-roll bar.

Rear: Compound crank with coil springs and gas-pressure dampers

- Sports suspension on SRi VX-Line Nav Black models.

Body

- Aerodynamic drag co-efficient: Cd 0.33

Fuel Tank Capacity

- 45 litres (9.9 gallons)

Brakes

- Anti-lock Braking System (ABS)
- Electronic brakeforce distribution
- Emergency brake assist
- Cornering brake control
- Straight line stability control
- Dual circuit, diagonally split, dual rate servo-assisted system
- Low brake fluid level warning light

1.4i (75PS)

Front ventilated discs: 257mm diameter

Rear drums: 228mm diameter

1.4i (90PS)

Front ventilated discs: 257mm diameter

Rear drums: 228mm diameter

1.4i Turbo (100PS)

Front ventilated discs: 284mm diameter

Rear discs: 264mm diameter

Weights and Towing Data kg

	Gross vehicle weight		Maximum towing weights Trailer with brakes (without brakes)	
	3-door	5-door	3-door	5-door
1.4i (75PS) Active	1585	–	800 (550)	–
1.4i (75PS) (excluding Active models)	1600	1620	800 (550)	800 (550)
1.4i (90PS)	1600	1630	800 (550)	800 (550)
1.4i (90PS) automatic	1630	1660	800 (550)	800 (550)
1.4i Turbo (100PS)	1680	1710	1150 (580)	1150 (580)

Gross vehicle weight is the total permissible weight of the vehicle including passengers and their luggage. The **maximum roof rack loading** should not exceed 75kg on all models. The **maximum towing weights** are based on the ability of the car, with two occupants of 75kg each, to restart on a 12% gradient, which is approximately 1 in 8.3, at sea level. The permitted trailer load applies up to the specified incline and up to an altitude of 1000 metres above sea level. The permissible gross train weight decreases by 10% for every 1000 metres of additional altitude. Any extra weight, such as luggage or additional passengers, should be deducted from the maximum towing weight. With a trailer fully loaded, **maximum noseweight** should not exceed 75kg. Always fit Vauxhall towing attachments and accessories available from your Vauxhall Retailer. They are designed specifically for Vauxhall models and carry a 12-month guarantee. During trailer towing do not exceed a maximum speed of 60mph. This speed limit is also applicable in countries with higher permitted speeds for trailer-vehicle combinations. Pay attention to the local speed limits. For trailers with low driving stability and caravans the use of an oscillation damper is strongly recommended.

PETROL ENGINES

Engine	1.4i (75PS)	1.4i (90PS) with or without Start/Stop	1.4i Turbo (100PS) Start/Stop
Capacity	1398cc	1398cc	1364cc
Maximum power	75PS (55kW) @ 4200-6000rpm	90PS (66kW) @ 6000rpm	100PS (74kW) @ 3500-6000rpm
Maximum torque	130Nm (96 lb.ft.) @ 4000rpm	130Nm (96 lb.ft.) @ 4000rpm	230Nm (169 lb.ft.) @ 1750rpm
Configuration	4 cylinders, 4 valves per cylinder, double overhead camshafts	4 cylinders, 4 valves per cylinder, double overhead camshafts	3 cylinders, 4 valves per cylinder, double overhead camshafts
Fuel/induction system	Naturally aspirated with Variable Valve Timing. Multi-point sequential fuel injection	Naturally aspirated with Variable Valve Timing. Multi-point sequential fuel injection	Turbocharger with intercooler. Variable Valve Timing. Multi-point sequential fuel injection
Emission compliance	Euro 6d-TEMP (6.2)	Euro 6d-TEMP (6.2)	Euro 6d-TEMP (6.2)
Service interval	20,000 miles or 1 year (whichever occurs sooner)	20,000 miles or 1 year (whichever occurs sooner)	20,000 miles or 1 year (whichever occurs sooner)

ACCESSORIES

CHILD SEATS¹ Total (inc. VAT)

BABY-SAFE ² – 0-13kg/birth to 15 months	£141
– ISOFIX base	£244
DUO ISOFIX ² – 9-18kg/9 months to 4 years	
with top tether kit	£372
KID ² – 15-36kg or 4 to 12 years	£168

SAFETY

Privacy shades – rear side windows (3-dr)	£75
Privacy shades – rear window (3-dr)	£92
Privacy shades – rear side windows (5-dr)	£94
Parking sensors	
– four fully flush front bumper mounted sensors	
– painted ³	£326
– four fully flush rear bumper mounted sensors	
– painted	£326
Safety Pack – first aid kit, hi-visibility vest and small warning triangle	£30
Warning triangle – Small	£12
Warning triangle – Large	£20
First aid kit	£15
Hi-visibility vest	£9
Fire extinguisher – 2kg	£39
Tyre sealant	£80

FLEXCONNECT RANGE

FlexConnect bracket	£22
FlexConnect hook	£32
FlexConnect coat hanger	£34
FlexConnect folding table	£77
FlexConnect iPad Mini cradle	£109
FlexConnect iPad (1-4) cradle	£118
FlexConnect iPad Air cradle	£117
FlexConnect Samsung Galaxy cradle	£107

PRACTICAL Total (inc. VAT)

Spare bulb kit – ultra white	£38
Stretch tow rope – 3000kg	£36
Flexible cupholder	£17
Foldable armrest with storage	£106

PROTECTION

Carpet floor mats – set of four	£34
Rubber floor mats – front pair	£39
Rubber floor mats – rear pair	£28
Velour floor mats – set of four	£65
Cargo liner	£79
Luggage storage box – with dividers	£114
Rear bumper protection foil	£58
Splash Guards – front and rear set ⁴	£114
Stainless steel door sills	£70
Illuminated door sills 3dr	£159

STYLING

Decal Package Sport Bonnet, Roof & Tailgate	
– 3dr White	£194
Stainless steel pedal covers – manual	£164
Exhaust tip	£69
Exterior Mirror Cap Carbon Flash	£43

TRANSPORT SYSTEMS Total (inc. VAT)

Roof base carrier	£151
Roof carriers (requires base carrier)	
Bike roof carrier – Thule Freeride 532	£78
Surf board roof carrier – Thule 833	£82
Kayak roof carrier – Thule 837	£172
Ski roof carrier (up to 4 pairs)	
– Thule Deluxe 7324	£161
Ski roof carrier (up to 6 pairs)	
– Thule 7326	£190
Hard shell roof boxes (requires base carrier)	
Thule Ocean 80	
(320 litre/1330 x 860 x 370mm)	£154
Thule Ocean 200	
(450 litre/1750 x 820 x 450mm)	£323
Thule Motion 800	
(460 litre/2050 x 840 x 450mm)	from £463
Thule Touring 200	
(400 litre/1750 x 820 x 450mm)	£338
Thule Touring 780	
(430 litre/2320 x 700 x 420mm)	£384

ALLOY WHEELS Total (inc. VAT)

(set of four with centre caps)⁵	
15-inch 8-spoke – silver	£666
16-inch 4-double-spoke – white or silver	£786
16-inch 4-double-spoke – black	£910
16-inch 6-double-spoke – silver	£786
17-inch 5-twin-spoke – silver	£1,147
17-inch 8-spoke – Titan gloss	£1,132

Please note: Prices shown are fully fitted and painted, where applicable and include VAT. Please check with your local Vauxhall Retailer for details. It is advisable to ensure your insurance policy is adequate to cover additional fitted accessories. Prices correct at time of publication.

¹Restrictions apply to the use of child seats, please consult your Vauxhall Retailer or request a copy of the Child seats brochure. ²Without transponder. ³For use in conjunction with rear parking sensors. ⁴Not available with certain exterior styling accessories.

⁵Fitting time is based on four wheels fitted and includes static wheel balancing. Different tyres and locking wheel nuts may be required. Price excludes new tyres and locking wheel nuts.

COMPANY CAR DRIVER AND FLEET INFORMATION

Design and Tech Line High Spec Low P11D

Specifically developed for businesses and company car drivers alike, our Design and Tech Line Nav models are seriously fit for Fleet.

Design models all feature very low P11D values, generous standard specification, including Sat Nav on Design Nav models, and a choice of high tech ecoTEC engines for great fuel economy and low emissions.

For even more standard specification, step up to our Tech Line Nav range. Again you are guaranteed low P11D values, plus great standard kit including Sat Nav, Bluetooth®, USB connection, aux-in socket and digital radio.

With Design and Tech Line Nav you can take for granted low Whole Life Costs and low company car driver taxation.

Company Car Driver Free 3 Day Test Drive

Our free* 3 Day Test Drive programme is open to all Company Car Drivers which allows you to choose any model in the current Vauxhall line-up (exclusions apply). With full insurance cover provided, it gives you a meaningful length of time to make an informed decision about your next company car.

Search Vauxhall 3DTD to book your FREE* test drive or click the link the below:

[Vauxhall 3 Day Test Drive](#)

*The free 3 Day Test Drive programme is open to Company Car Drivers and Fleet Decision Makers. Available for UK Mainland only. Terms and conditions apply. Full terms and conditions can be found at vauxhallfleet.co.uk/testdrive/index/terms.

Benefit in kind company car taxation†

The car benefit charge will be the car's list price (including VAT, options and accessories fitted, delivery to Retailer and number plates, but excluding Vehicle Excise Duty and new vehicle first registration fee) multiplied by the percentage charge for the CO₂ emissions band in which the car falls (see table opposite). Multiply this figure by your personal income tax rate (20%^{††} for Basic Rate, 40%^{††} for Higher Rate) to calculate your annual benefit in kind tax liability.

Example:

Corsa SE Nav 1.4i Turbo (100PS) Start/Stop 5-door hatchback (CO₂ emissions 125g/km)

On-the-road RRP	£17,335.00
Deduct: Vehicle Excise Duty	(£170.00)
New vehicle first registration fee	(£55.00)
Effective list price	£17,110.00
Add: Optional two-coat metallic paint	£565.00
List price for tax purposes (P11D value)	£17,675.00
Car benefit charge 2019–20 tax year (29%)	£5,126.00
Benefit in kind tax liability (2019–20 tax year)	
Basic Rate (20%) tax payer	£1,025.20
Higher Rate (40%) tax payer	£2,050.40

†Please note this Price Guide provides taxation information as a guide only. Vauxhall does not provide taxation guidance. Drivers should always take professional advice on their own tax position.

††Excludes residents of Scotland.

BIK FOR SCOTTISH RESIDENTS

Effective 6 April 2018 the Scottish Government have introduced their own BIK taxation structure. This only applies to Company Car Drivers that are Scottish taxpayers. HMRC will determine whether or not an individual is a Scottish taxpayer based on where their main place of residence is.

The BIK rates for Scotland are:

- Over £12,500–£14,549 Starter Rate 19%
- Over £14,549–£24,994 Basic Rate 20%
- Over £24,994–£43,430 Intermediate Rate 21%
- Over £43,430–£150,000 Higher Rate 41%
- Above £150,000 Top Rate 46%

Benefit in kind company car taxation table

CO ₂ emissions in grams per kilometre	Percentage of cars price to be taxed	
	Non-Diesel [‡] 2019-20 tax year	Diesel ^{‡‡} 2019-20 tax year
Up to 50	16	20
51-75	19	23
76-94	22	26
95-99	23	27
100-104	24	28
105-109	25	29
110-114	26	30
115-119	27	31
120-124	28	32
125-129	29	33
130-134	30	34
135-139	31	35
140-144	32	36
145-149	33	37
150-154	34	37
155-159	35	37
160-164	36	37
165-169	37	37
170-174	37	37
175-179	37	37
180 and above	37	37

[‡]Also applies to diesel vehicles that meet the Real Driving Emissions Step 2 (RDE2). ^{‡‡}Applies to vehicles that do not meet the Real Driving Emissions Step 2 (RDE2).

To calculate your own personal liability, search: **Vauxhall BiK**, or click the link below: [Vauxhall BiK Tool](#)

Fleet Toolbox

Discover the facts in our online Toolbox for both Company Car Drivers and Fleet Decision Makers. The Fleet Toolbox has a host of useful calculators, comparators, interactive listings and information.

Search Vauxhall Fleet Tools or click the link below: [Vauxhall Fleet Tool Box](#)

Contact Vauxhall Fleet

Please contact one of our dedicated sales teams who will be happy to help with your particular enquiry.

Company Car Drivers

Call: 0345 111 2020

Email: company-car@vauxhallinfo.co.uk

Telephone lines are open

– Monday to Friday 8:00am–9:00pm

– Saturday and Sunday 9:00am–6:00pm

Fleet Decision Makers

Depending on the size of your fleet of vehicles, we have a dedicated team to handle your enquiries. The lines are open Monday to Friday excluding Bank Holidays.

1-24 vehicles

Call: 0845 076 2254 (8:30am–5:00pm)

25+ vehicles

Call: 0330 587 8222 (8:30am–5:00pm)

Email: vauxhallfleet@vauxhall.co.uk

Special Vehicles (Police, Fire and Ambulance)

Call: 01582 409999 (8:30am–5:00pm)

Email: vauxhallspecialvehicles@vauxhall.co.uk

For more information visit www.vauxhall.co.uk/fleet

FURTHER INFORMATION

On-the-road prices

To eliminate uncertainty about hidden costs when buying a new car, Vauxhall publishes on-the-road recommended retail prices (RRP) and these are shown in the pricing tables within this price guide. These prices include VAT, number plates and delivery to Retailer of £700.00 (including £116.67 VAT), 12 months' Government Vehicle Excise Duty (see opposite for details) and the DVLA new vehicle first registration fee of £55.00.*

Please note: The on-the-road recommended retail price (RRP) does not include fuel supplied by the Retailer, motor insurance or any other goods or services supplied by agreement between the Retailer and the customer.

Price protection

Order a new Vauxhall for build in the current model year (as confirmed by your Retailer) for delivery no more than three months in advance and the price you are quoted is the price you pay. This is irrespective of any subsequent price rises between placing your order and delivery of your new car, but you must take delivery as soon as the car is available. Vauxhall Motors Limited is not liable for price adjustments caused by Government changes in the rate of VAT (currently 20%), Vehicle Excise Duty, DVLA new vehicle first registration fee or by any other applicable legislation or regulations.

Vauxhall Finance Leasing

Vauxhall Finance Leasing is a trading style of Vauxhall Finance plc. Working with the Vauxhall Retailer network we provide competitive car and van leasing solutions for business users and private individuals. We combine the support of a national contract with the convenience of a local contact.

For further information, please contact your local Vauxhall Retailer or visit www.vauxhall.co.uk/leasing

In the event of an accident

Vauxhall Accident Management helps keep you mobile following an accident. Benefits include vehicle recovery, Vauxhall-approved repairs and contacting your insurer. For more details, visit www.vauxhall.co.uk/AccidentManagement

Vehicle Excise Duty

The amount of Vehicle Excise Duty (road fund licence) payable on new cars varies depending on the level of carbon dioxide (CO₂) emissions produced by the vehicle. CO₂ emissions are measured in grams per kilometre (g/km) travelled and divided into 13 charging bands shown in the table opposite.

A 'first year rate' of Vehicle Excise Duty is payable on all new cars and in subsequent years the amount payable reverts to the 'standard rate'. From 1 April 2017 the breakpoints for each of these bands have been revised. Also, for vehicles with a list price over £40,000, including factory-fitted options, an additional £320 is payable for the first five years of standard rate payments.

Vehicle Excise Duty*

Band	CO ₂ emissions in grams per kilometre	First year rate		Standard rate
		Petrol [#]	Diesel [†]	
A	0	£0	£0	£0
B	1-50	£10	£25	£145
C	51-75	£25	£110	£145
D	76-90	£110	£130	£145
E	91-100	£130	£150	£145
F	101-110	£150	£170	£145
G	111-130	£170	£210	£145
H	131-150	£210	£530	£145
I	151-170	£530	£855	£145
J	171-190	£855	£1,280	£145
K	191-225	£1,280	£1,815	£145
L	226-255	£1,815	£2,135	£145
M	over 255	£2,135	£2,135	£145

*Correct at time of issue.

[#]Also applies to diesel vehicles that meet the Real Driving Emissions Step 2 (RDE2).

[†]Applies to vehicles that do not meet the Real Driving Emissions Step 2 (RDE2).

FURTHER INFORMATION

Customer Care Commitment

For added peace of mind, Vauxhall has an innovative Customer Care Commitment that offers the following:

- Three-year vehicle warranty consisting of a one-year/unlimited mileage manufacturer's warranty and a second and third year manufacturer's warranty with a 60,000 miles limitation
- Vauxhall Assistance for 12 months from first registration
- Six years' body panel anti-perforation warranty

Please note: Warranty is only available on vehicles sourced from Vauxhall Motors Limited. Terms and conditions apply – please see your Vauxhall Retailer for details.

Vauxhall Assistance

Vauxhall Assistance is provided automatically with every new Vauxhall for 12 months from first registration and covers everything from accident assistance, roadside recovery and 'at home' service to flat tyres. With Vauxhall Assistance help is literally just a free* phone call away, 24 hours a day, 365 days a year!

Protecting the environment

Vauxhall's commitment to the environment is demonstrated by our products' many environmental awards. For even more information on Vauxhall's efforts to achieve an environmentally sustainable future, and how to dispose of your end-of-life vehicle, see www.vauxhall.co.uk/recycling

Vauxhall Service Plan

- Fixed monthly payments for the plan duration
- Easy to budget and interest-free
- Genuine parts fitted by Vauxhall-trained technicians

Plus on Gold plans:

- Valet and courtesy car
- Vauxhall Roadside Assistance
- Engine flush and fuel treatments
- Litre of oil for top ups between services

Full details can be obtained from your local participating Vauxhall Retailer.

Vauxhall Insurance with added reassurance

Comprehensive cover – Summary of benefits**

- Competitive premiums
- Repairs by a Vauxhall-trained technician
- Genuine Vauxhall parts, guaranteed for three years when we repair your car within our Approved Repairer Network
- Free courtesy car as standard when using an Approved Repairer†
- 24 hour claims helpline
- Personal Accident benefit
- Cover for audio equipment
- Windscreen cover

Call for a quote on **0844 463 2670**††

For more product information

For further information on the Vauxhall range or location of your nearest Vauxhall Retailer please call **0345 600 1500**. Alternatively, details can be found on our website at www.vauxhall.co.uk

*Mobile phone users will be charged at their standard tariff.

**The benefits listed above are for comprehensive cover only. For details of Third Party, Fire and Theft cover, please call our sales team.

†Should your car need repairing following an accident we provide a courtesy car (subject to availability) for the duration of the repair. Only genuine Vauxhall parts are used. Terms and conditions apply.

††Calls may be recorded. Vauxhall Insurance is underwritten by Ageas Insurance Limited.

Take the next step:



Join us online:

Discover the full Vauxhall range at [vauxhall.co.uk](https://www.vauxhall.co.uk) >

Privacy Policy: For full details please visit [vauxhall.co.uk/privacy](https://www.vauxhall.co.uk/privacy)

The invoice price, including delivery to Retailer, factory-fitted options, accessories fitted by the Retailer and number plates, is subject to VAT. Some feature descriptions in this guide may refer to, and some illustrations may show, optional equipment not included in the standard delivery. The information contained in this guide was accurate at the time of publication. We reserve the right to make changes in design and equipment. Please note that Vauxhall Retailers are not the agents of Vauxhall Motors Limited and are not authorised to bind Vauxhall Motors Limited by any specific or implied undertaking or representation. It is advisable to ensure that your motor insurance policy provides adequate cover for additional fitted options and accessories. The colours in this guide are only approximate actual colours. Illustrated optional equipment is available at extra charge. Availability, technical features and equipment provided on our vehicles can vary by model. For precise information on the equipment provided on our vehicles, please contact your local Vauxhall Retailer.

ASTRA

Price and Specification Guide | 1 May 2019 | Model Year 2019.5



VAUXHALL
British Brand since 1903

CONTENTS

To find the information you want use the links below to navigate around the guide:

[RANGE HIGHLIGHTS >](#)

Explore the Astra range and find your perfect model.

[MODELS >](#)

Find all the information you need about your chosen model.

[PRICES >](#)

Find on-the-road recommended retail prices.

[FEATURES/OPTIONS >](#)

Tailor your chosen model to suit your needs with everything from satellite navigation to rear-view camera and parking sensors.

[EXTERIOR COLOURS >](#)

Add some sparkle to your car with a metallic paint.

[WHEELS AND TYRES >](#)

Why not upgrade to a set of distinctive alloy wheels to give your car more presence.

[PERFORMANCE, FUEL ECONOMY AND EMISSIONS >](#)

Know how many miles you will get around town, the CO₂ figures and the 0-60 time.

[DIMENSIONS >](#)

Ensure your car will fit in the garage and know how much luggage you can take for a long weekend away.

[SPECIFICATIONS >](#)

Towing weights, engine details and other useful details you may need to know.

[ACCESSORIES >](#)

Add some practical touches to your car with our range of quality accessories.

[COMPANY CAR INFORMATION >](#)

Benefit in Kind company car tax, 3 day test drives and P11D.

[FURTHER INFORMATION >](#)

Price protection, vehicle excise duty, our range of additional products and much more.

ASTRA RANGE HIGHLIGHTS



DESIGN OTR from £18,905

Standard features include:

Infotainment:

- IntelliLink audio system
 - 7-inch colour touchscreen
 - AM/FM/DAB digital radio
 - Bluetooth® audio streaming
 - Bluetooth® mobile phone portal
 - Apple CarPlay™/Android Auto™
 - USB audio connection
- Four speakers (front)

Interior convenience/styling:

- Air conditioning • Multi-function trip computer
- Cruise control with speed limiter
- Steering wheel audio/phone/cruise controls
- Steering column adjustable for reach/rake

Exterior convenience/styling:

- 16-inch alloy wheels • Front fog lights
- Dark-tinted rear windows
- Automatic lighting control
- Electrically operated front/rear windows
- Remote control central locking
- Electrically adjustable/heated door mirrors
- Black roof rails (Sports Tourer)

Safety/security:

- Electronic Stability Programme (ESP)
- Anti-lock Braking System (ABS)
- Six airbags • Hill start assist
- ISOFIX child seat mounting points on outer rear seats
- Door-to-door illumination
- LED daytime running lights
- Electronic engine deadlock immobiliser



TECH LINE NAV OTR from £19,605

Features over Design:

Infotainment:

- Navi R4.0 IntelliLink system
 - Fully integrated European sat nav system

Interior convenience/styling:

- Leather-covered steering wheel
- Adjustable front armrest



GRIFFIN PRICE AVAILABLE ON REQUEST FROM RETAILER

Features over Design:

Infotainment:

- Navi 4.0 IntelliLink system
 - Fully integrated European sat nav system

Interior convenience/styling:

- Electronic dual-zone climate control
- Auto anti-dazzle rear-view mirror
- Driver's ergonomic active seat
- Leather-covered heated steering wheel
- Heated front seats
- Front centre armrest
- Front and rear floor mats (front Griffin-branded)

Exterior convenience/styling:

- Rain-sensitive windscreen wipers
- Automatic lighting control with tunnel detection
- 18-inch bi-colour alloy wheels
- Range of brilliant, metallic and premium colours available at no additional cost

Safety/security:

- Remote control alarm system

Colours and model variants for Griffin special edition subject to availability. Please check with your Vauxhall Retailer.



SRi OTR from £21,765

Features over Design:

Infotainment:

- Six speakers (four front, two rear)

Interior convenience/styling:

- Leather-covered steering wheel
- Sports-style front seats
- Driver's ergonomic active seat
- Front centre armrest
- Storage pockets on front seat backs
- Sport switch

Exterior convenience/styling:

- 17-inch five twin-spoke alloy wheels
- Chrome-effect upper window trim
- Rain-sensitive windscreen wipers
- Automatic lighting control with tunnel detection
- Automatic anti-dazzle rear-view mirror
- Silver-effect roof rails (Sports Tourer)

Safety/security:

- Driving Assistance Pack One featuring intelligent forward camera system
- Remote control alarm system (Optional at extra cost on 1.0 Turbo (105PS) models)

SRi NAV

SRi Nav models additionally feature:

- Navi R4.0 IntelliLink system
 - Fully integrated European sat nav system

Please note: Astra SRi does not feature dark-tinted rear windows.

ASTRA RANGE HIGHLIGHTS



DESIGN OTR from £18,905

Standard features include:

Infotainment:

- IntelliLink audio system
 - 7-inch colour touchscreen
 - AM/FM/DAB digital radio
 - Bluetooth® audio streaming
 - Bluetooth® mobile phone portal
 - Apple CarPlay™/Android Auto™
 - USB audio connection
- Four speakers (front)

Interior convenience/styling:

- Air conditioning • Multi-function trip computer
- Cruise control with speed limiter
- Steering wheel audio/phone/cruise controls
- Steering column adjustable for reach/rake

Exterior convenience/styling:

- 16-inch alloy wheels • Front fog lights
- Dark-tinted rear windows
- Automatic lighting control
- Electrically operated front/rear windows
- Remote control central locking
- Electrically adjustable/heated door mirrors
- Black roof rails (Sports Tourer)

Safety/security:

- Electronic Stability Programme (ESP)
- Anti-lock Braking System (ABS)
- Six airbags • Hill start assist
- ISOFIX child seat mounting points on outer rear seats
- Door-to-door illumination
- LED daytime running lights
- Electronic engine deadlock immobiliser



SRI VX-LINE OTR from £23,535

Features over Design:

Infotainment:

- Six speakers (four front, two rear)

Interior convenience/styling:

- Leather-covered steering wheel
- Sports-style front seats
- Driver's ergonomic active seat
- Front centre armrest
- Storage pockets on front seat backs
- Sport switch

Exterior convenience/styling:

- 18-inch five twin-spoke alloy wheels
- Chrome-effect upper window trim
- Sports-style front and rear bumper/side sills
- Rain-sensitive windscreen wipers
- Automatic lighting control with tunnel detection
- Automatic anti-dazzle rear-view mirror

Safety/security:

- Driving Assistance Pack One featuring intelligent forward camera system
- Remote control alarm system

SRI NAV VX-LINE

SRI VX-LINE Nav models additionally feature:

- Navi R4.0 IntelliLink system
 - Fully integrated European sat nav system

Please note: Astra SRi VX-Line does not feature front fog lights or dark-tinted rear windows.



ELITE NAV OTR from £22,925

Features over Design:

Infotainment:

- Navi 900 IntelliLink system
 - Fully integrated European sat nav system
 - 8-inch colour touchscreen
- Six speakers (four front, two rear)

Interior convenience/styling:

- Leather seat trim
- Electronic dual-zone climate control
- Heated leather-covered steering wheel
- Heated front/outer rear seats
- Sports-style front seats
- Four-way electrical lumbar adjustment
- Front centre armrest
- Storage pockets on front seat backs
- Electric parking brake
- Two rear USB charging points
- Front door sill covers

Exterior convenience/styling:

- 17-inch multi-spoke alloy wheels
- Chrome-effect upper window trim
- Rain-sensitive windscreen wipers
- Automatic lighting control with tunnel detection
- Automatic anti-dazzle rear-view mirror
- Electrically folding door mirrors
- Silver-effect roof rails (Sports Tourer)

Safety/security:

- Remote control alarm system

Please note: Astra Elite Nav does not feature dark-tinted rear windows.



ULTIMATE OTR from £26,295

Features over Design:

Infotainment:

- Navi 900 IntelliLink system
 - Fully integrated European sat nav system
 - 8-inch colour touchscreen
- Six speakers (four front, two rear)

Interior convenience/styling:

- Perforated leather seat trim
- Electronic dual-zone climate control
- Heated leather-covered steering wheel
- Heated front/outer rear seats
- Driver's and front passenger's ergonomic active seats
- Four-way electrical lumbar adjustment
- Front centre armrest • Centre rear armrest
- Storage pockets on front seat backs
- Electric parking brake • Front door sill covers
- Two rear USB charging points

Exterior convenience/styling:

- 18-inch bi-colour alloy wheels
- IntelliLux LED Matrix headlights
- Parking Pack: Front and rear parking distance sensors/Advance park assist/Rear-view camera/Side blind spot alert
- Chrome-effect upper window trim
- Rain-sensitive windscreen wipers
- Automatic lighting control with tunnel detection
- Automatic anti-dazzle rear-view mirror
- Electrically folding door mirrors

Safety/security:

- Driving Assistance Pack One featuring intelligent forward camera system
- Remote control alarm system

DESIGN



DESIGN ON-THE-ROAD PRICES

	Hatchback		Sports Tourer		Insurance
	OTR RRP	CO ₂ (g/km)	OTR RRP	CO ₂ (g/km)	Group
Petrol					
1.0i Turbo (105PS) S/S ecoTEC	£18,905	107	£20,355	107	12E
1.4i Turbo (125PS) S/S	£19,225	122	£20,675	124	14E
1.4i Turbo (150PS) S/S auto	£20,575	130	-	-	15E
Diesel					
1.6CDTi (110PS) S/S ecoTEC	£20,375	107	£21,865	112	13E
1.6CDTi (136PS) S/S	£21,105	116	£22,555	118	19A

Please note: On-the-road recommended retail prices (RRP) include VAT at 20%, number plates and delivery to Retailer of £700.00 (inc. £116.67 VAT), 12 months' Vehicle Excise Duty and new vehicle first registration fee of £55.00. Excludes fuel and insurance.

All diesel models feature BlueInjection, see www.vauxhall.co.uk/adblue.

S/S = Start/Stop.



FEATURES

Infotainment:

- IntelliLink audio system
 - 7-inch colour touchscreen
 - AM/FM/DAB digital radio
 - Bluetooth® audio streaming
 - Bluetooth® mobile phone portal
 - Apple CarPlay™/Android Auto™
 - USB audio connection
- Four speakers (front)

Interior convenience/styling:

- Air conditioning
- Multi-function trip computer
- Cruise control with speed limiter
- Steering wheel audio/phone/cruise controls
- Steering column adjustable for reach/rake

Exterior convenience/styling:

- 16-inch alloy wheels
- Automatic lighting control
- Electrically operated front/rear windows
- Remote control central locking
- Electrically adjustable/heated door mirrors
- Black roof rails (Sports Tourer)
- Front fog lights
- Dark-tinted rear windows

Safety/security:

- Electronic Stability Programme (ESP)
- Anti-lock Braking System (ABS)
- Six airbags
- Hill start assist
- ISOFIX child seat mounting points on outer rear seats
- Tyre pressure monitoring system
- Door-to-door illumination
- LED daytime running lights
- Electronic engine deadlock immobiliser

TECH LINE NAV



TECH LINE NAV ON-THE-ROAD PRICES

	Hatchback		Sports Tourer		Insurance Group
	OTR RRP	CO ₂ (g/km)	OTR RRP	CO ₂ (g/km)	
Petrol					
1.0i Turbo (105PS) S/S ecoTEC	£19,605	107	£21,055	107	11E
1.4i Turbo (125PS) S/S	£19,925	122	£21,375	124	14E
1.4i Turbo (150PS) S/S auto	£21,275	130	-	-	16E
Diesel					
1.6CDTi (110PS) S/S ecoTEC	£21,075	107	£22,565	112	13E
1.6CDTi (136PS) S/S	£21,805	116	£23,255	118	17E
1.6CDTi (136PS) S/S auto	£23,125	122	-	-	17E

Please note: On-the-road recommended retail prices (RRP) include VAT at 20%, number plates and delivery to Retailer of £700.00 (inc. £116.67 VAT), 12 months' Vehicle Excise Duty and new vehicle first registration fee of £55.00. Excludes fuel and insurance.

All diesel models feature BlueInjection, see www.vauxhall.co.uk/adblue.

S/S = Start/Stop.

FEATURES

Infotainment:

- Navi R4.0 IntelliLink system
 - Fully integrated European sat nav system
 - 7-inch colour touchscreen
 - AM/FM/DAB digital radio
 - Bluetooth® audio streaming
 - Bluetooth® mobile phone portal
 - Apple CarPlay™/Android Auto™
 - USB audio connection
- Four speakers (front)

Interior convenience/styling:

- Air conditioning
- Multi-function trip computer
- Cruise control with speed limiter
- Leather-covered steering wheel
- Front centre armrest
- Steering wheel audio/phone/cruise controls
- Steering column adjustable for reach/rake

Exterior convenience/styling:

- 16-inch alloy wheels
- Automatic lighting control
- Electrically operated front/rear windows
- Remote control central locking
- Electrically adjustable/heated door mirrors
- Black roof rails (Sports Tourer)
- Front fog lights
- Dark-tinted rear windows

Safety/security:

- Electronic Stability Programme (ESP)
- Anti-lock Braking System (ABS)
- Six airbags
- Hill start assist
- ISOFIX child seat mounting points on outer rear seats
- Tyre pressure monitoring system
- Door-to-door illumination
- LED daytime running lights
- Electronic engine deadlock immobiliser

GRIFFIN



GRIFFIN PRICE AVAILABLE ON REQUEST FROM RETAILER

	Hatchback CO ₂ (g/km)	Insurance Group
Petrol		
1.4i Turbo (150PS)	138	20E
1.4i Turbo (150PS) S/S	125	20E
1.4i Turbo (150PS) S/S auto	139	20E
Diesel		
1.6CDTi (136PS) S/S	121	20E

All diesel models feature BlueInjection, see www.vauxhall.co.uk/adblue.

S/S = Start/Stop.

Colours and model variants for Griffin special edition subject to availability. Please check with your Vauxhall Retailer.

FEATURES

Infotainment:

- Navi R4.0 IntelliLink system
 - Fully integrated European sat nav system
 - 7-inch colour touchscreen
 - AM/FM/DAB digital radio
 - Bluetooth® audio streaming
 - Bluetooth® mobile phone portal
 - Apple CarPlay™/Android Auto™
 - USB audio connection
- Six speakers (four front, two rear)

Interior convenience/styling:

- Electronic dual-zone climate control
- Automatic anti-dazzle rear-view mirror
- Driver's ergonomic active seat
- Heated, leather-covered steering wheel
- Heated front seats
- Front centre armrest
- Front and rear floor mats (front Griffin-branded)
- Multi-function trip computer
- Cruise control with speed limiter
- Steering wheel audio/phone/cruise controls
- Steering column adjustable for reach/rake
- Fabric/premium leather effect seat trim
- Electric parking brake

Exterior convenience/styling:

- 18-inch bi-colour alloy wheels
- Rain-sensitive windscreen wipers
- Automatic lighting control with tunnel detection
- Dark-tinted rear windows
- Electrically operated front/rear windows
- Electrically adjustable/heated/folding door mirrors
- Remote control central locking
- Front fog lights
- Range of brilliant, metallic and premium colours available at no additional cost

Safety/security:

- Remote control alarm system
- LED daytime running lights
- Electronic Stability Programme (ESP)
- Anti-lock Braking System (ABS)
- Six airbags
- Hill start assist
- ISOFIX child seat mounting points on outer rear seats
- Tyre pressure monitoring system
- Door-to-door illumination
- Electronic engine deadlock immobiliser

SRI



SRI ON-THE-ROAD PRICES

	Hatchback		Sports Tourer		Insurance Group
	OTR RRP	CO ₂ (g/km)	OTR RRP	CO ₂ (g/km)	
Petrol					
1.0i Turbo (105PS) S/S ecoTEC	£21,765	110	-	-	10E
1.4i Turbo (150PS) S/S	£22,335	123	£23,785	125	16E
1.4i Turbo (150PS) S/S auto	£23,475	134	£24,925	134	16E
Diesel					
1.6CDTi (110PS) S/S ecoTEC	£23,235	110	£24,725	116	12E
1.6CDTi (136PS) S/S	£23,965	118	£25,415	121	15E
1.6CDTi (136PS) S/S auto	£25,285	126	£26,735	130	15E

SRI NAV ON-THE-ROAD PRICES

	Hatchback		Sports Tourer		Insurance Group
	OTR RRP	CO ₂ (g/km)	OTR RRP	CO ₂ (g/km)	
Petrol					
1.0i Turbo (105PS) S/S ecoTEC	£22,465	110	-	-	10E
1.4i Turbo (150PS) S/S	£23,035	123	£24,485	125	16E
1.4i Turbo (150PS) S/S auto	£24,175	134	£25,625	134	16E
Diesel					
1.6CDTi (110PS) S/S ecoTEC	£23,935	110	£25,425	116	12E
1.6CDTi (136PS) S/S	£24,665	118	£26,115	121	15E
1.6CDTi (136PS) S/S auto	£25,985	126	£27,435	130	15E

Please note: On-the-road recommended retail prices (RRP) include VAT at 20%, number plates and delivery to Retailer of £700.00 (inc. £116.67 VAT), 12 months' Vehicle Excise Duty and new vehicle first registration fee of £55.00. Excludes fuel and insurance. All diesel models feature BlueInjection, see www.vauxhall.co.uk/adblue.

S/S = Start/Stop.

FEATURES

Infotainment:

- IntelliLink audio system
 - 7-inch colour touchscreen
 - AM/FM/DAB digital radio
 - Bluetooth® audio streaming
 - Bluetooth® mobile phone portal
 - Apple CarPlay™/Android Auto™
 - USB audio connection
- Six speakers (four front, two rear)

Interior convenience/styling:

- Air conditioning
- Multi-function trip computer
- Sports-style front seats
- Driver's ergonomic active seat
- Front centre armrest
- Storage pockets on front seat backs
- Cruise control with speed limiter
- Steering wheel audio/phone/cruise controls
- Sport switch
- Steering column adjustable for reach/rake

Exterior convenience/styling:

- 17-inch five twin-spoke alloy wheels
- Chrome-effect upper window trim
- Rain-sensitive windscreen wipers
- Automatic lighting control with tunnel detection
- Automatic anti-dazzle rear-view mirror

- Front fog lights
- Remote control central locking
- Electrically operated front/rear windows
- Electrically adjustable/heated door mirrors
- Silver-effect roof rails (Sports Tourer)

Safety/security:

- Driving Assistance Pack One featuring intelligent forward camera system
- Electronic Stability Programme (ESP)
- Anti-lock Braking System (ABS)
- Six airbags
- Hill start assist
- ISOFIX child seat mounting points on outer rear seats
- Tyre pressure monitoring system
- LED daytime running lights
- Remote control alarm system (optional at extra cost on 1.0i Turbo (105PS) models)
- Electronic engine deadlock immobiliser

SRI NAV MODELS ADDITIONALLY FEATURE

Infotainment:

- Navi R4.0 IntelliLink system
 - Fully integrated European sat nav system

SRI VX-LINE



SRI VX-LINE ON-THE-ROAD PRICES

	Hatchback		Insurance Group
	OTR RRP	CO ₂ (g/km)	
Petrol			
1.4i Turbo (150PS) S/S	£23,535	125	16E
Diesel			
1.6CDTi (136PS) S/S	£25,165	121	15E

SRI VX-LINE NAV ON-THE-ROAD PRICES

	Hatchback		Insurance Group
	OTR RRP	CO ₂ (g/km)	
Petrol			
1.4i Turbo (150PS) S/S	£24,235	125	16E
Diesel			
1.6CDTi (136PS) S/S	£25,865	121	15E

Please note: On-the-road recommended retail prices (RRP) include VAT at 20%, number plates and delivery to Retailer of £700.00 (inc. £116.67 VAT), 12 months' Vehicle Excise Duty and new vehicle first registration fee of £55.00. Excludes fuel and insurance.

All diesel models feature BlueInjection, see www.vauxhall.co.uk/adblue.

S/S = Start/Stop.

FEATURES

Infotainment:

- IntelliLink audio system
 - 7-inch colour touchscreen
 - AM/FM/DAB digital radio
 - Bluetooth® audio streaming
 - Bluetooth® mobile phone portal
 - Apple CarPlay™/Android Auto™
 - USB audio connection
- Six speakers (four front, two rear)

Interior convenience/styling:

- Air conditioning
- Multi-function trip computer
- Sports-style front seats
- Driver's ergonomic active seat
- Front centre armrest
- Storage pockets on front seat backs
- Cruise control with speed limiter
- Steering wheel audio/phone/cruise controls
- Sport switch
- Steering column adjustable for reach/rake

Exterior convenience/styling:

- 18-inch five twin-spoke alloy wheels
- Body-colour front lower spoiler/side sills/rear lower skirt
- Chrome-effect upper window trim
- Rain-sensitive windscreen wipers

- Automatic lighting control with tunnel detection
- Automatic anti-dazzle rear-view mirror
- Remote control central locking
- Electrically operated front and rear windows
- Electrically adjustable/heated door mirrors

Safety/security:

- Driving Assistance Pack One featuring intelligent forward camera system
- Electronic Stability Programme (ESP)
- Anti-lock Braking System (ABS)
- Six airbags
- Hill start assist
- ISOFIX child seat mounting points on outer rear seats
- Tyre pressure monitoring system
- LED daytime running lights
- Remote control alarm system
- Electronic engine deadlock immobiliser

SRI VX-LINE NAV MODELS ADDITIONALLY FEATURE

Infotainment:

- Navi R4.0 IntelliLink system
 - Fully integrated European sat nav system

ELITE NAV



ELITE NAV ON-THE-ROAD PRICES

	Hatchback		Sports Tourer		Insurance Group
	OTR RRP	CO ₂ (g/km)	OTR RRP	CO ₂ (g/km)	
Petrol					
1.0i Turbo (105PS) S/S ecoTEC	£22,925	110	-	-	12E
1.4i Turbo (150PS) S/S	£23,495	123	£24,945	125	18E
1.4i Turbo (150PS) S/S auto	£24,635	134	£26,085	134	18E
Diesel					
1.6CDTi (110PS) S/S ecoTEC	£24,395	110	£25,885	116	15E
1.6CDTi (136PS) S/S	£25,125	118	£26,575	121	18E
1.6CDTi (136PS) S/S auto	£26,445	126	£27,895	130	18E

Please note: On-the-road recommended retail prices (RRP) include VAT at 20%, number plates and delivery to Retailer of £700.00 (inc. £116.67 VAT), 12 months' Vehicle Excise Duty and new vehicle first registration fee of £55.00. Excludes fuel and insurance.

All diesel models feature BlueInjection, see www.vauxhall.co.uk/adblue.

S/S = Start/Stop.

FEATURES

Infotainment:

- Navi 900 IntelliLink system
 - Fully integrated European sat nav system
 - 8-inch colour touchscreen
 - AM/FM/DAB digital radio
 - Bluetooth® audio streaming
 - Bluetooth® mobile phone portal
 - Apple CarPlay™/Android Auto™
 - USB audio connection
- Six speakers (four front, two rear)

Interior convenience/styling:

- Leather seat trim
- Electronic dual-zone climate control
- Heated leather-covered steering wheel
- Heated front/outer rear seats
- Sports-style front seats
- Four-way electrical lumbar adjustment
- Adjustable front armrest
- Multi-function trip computer
- Steering wheel audio/phone/cruise controls
- Electric parking brake
- Cruise control with speed limiter
- Two rear USB charging points

Exterior convenience/styling:

- 17-inch multi-spoke alloy wheels
- Chrome-effect upper window trim
- Rain-sensitive windscreen wipers
- Automatic lighting control with tunnel detection
- Automatic anti-dazzle rear-view mirror
- Front fog lights
- Remote control central locking
- Electrically operated front/rear windows
- Electrically adjustable/heated/folding door mirrors
- Silver-effect roof rails (Sports Tourer)

Safety/security:

- Electronic Stability Programme (ESP)
- Anti-lock Braking System (ABS)
- Six airbags
- Remote control alarm system
- Hill start assist
- ISOFIX child seat mounting points on outer rear seats
- Electronic engine deadlock immobiliser
- Tyre pressure monitoring system
- Door-to-door illumination
- LED daytime running lights

ULTIMATE



ULTIMATE ON-THE-ROAD PRICES

	Hatchback		Insurance Group
	OTR RRP	CO ₂ (g/km)	
Petrol			
1.4i Turbo (150PS) S/S	£26,295	125	20E
1.4i Turbo (150PS) S/S auto	£27,435	139	20E

Please note: On-the-road recommended retail prices (RRP) include VAT at 20%, number plates and delivery to Retailer of £700.00 (inc. £116.67 VAT), 12 months' Vehicle Excise Duty and new vehicle first registration fee of £55.00. Excludes fuel and insurance.

All diesel models feature BlueInjection, see www.vauxhall.co.uk/adblue.

S/S = Start/Stop.

FEATURES

Infotainment:

- Navi 900 IntelliLink system
 - Fully integrated European sat nav system
 - 8-inch colour touchscreen
 - AM/FM/DAB digital radio
 - Bluetooth® audio streaming
 - Bluetooth® mobile phone portal
 - Apple CarPlay™/Android Auto™
 - USB audio connection
- Six speakers (four front, two rear)

Interior convenience/styling:

- Perforated leather seat trim
- Electronic dual-zone climate control
- Heated leather-covered steering wheel
- Heated front/outer rear seats
- Sports-style front seats
- Driver's and front passenger's ergonomic active seats
- Four-way electrical lumbar adjustment
- Adjustable front armrest
- Centre rear armrest
- Multi-function trip computer
- Steering wheel audio/phone/cruise controls
- Electric parking brake
- Cruise control with speed limiter
- Two rear USB charging points

Exterior convenience/styling:

- 18-inch bi-colour alloy wheels
- Chrome-effect upper window trim

- Rain-sensitive windscreen wipers
- Automatic lighting control with tunnel detection
- Automatic anti-dazzle rear-view mirror
- IntelliLux LED Matrix headlights
- Front fog lights
- Parking Pack
 - Front and rear parking distance sensors
 - Advance park assist
 - Side blind spot alert
 - Rear-view camera
- Remote control central locking
- Electrically operated front/rear windows
- Electrically adjustable/heated/folding door mirrors
- Dark-tinted rear windows

Safety/security:

- Driving Assistance Pack One featuring intelligent forward camera system
- Electronic Stability Programme (ESP)
- Anti-lock Braking System (ABS)
- Six airbags
- Remote control alarm system
- Hill start assist
- ISOFIX child seat mounting points on outer rear seats
- Electronic engine deadlock immobiliser
- Tyre pressure monitoring system
- Door-to-door illumination
- LED daytime running lights
- LED tail lights

ASTRA HATCHBACK PRICES

	Price (£)	VAT (£)	Total (£)	On-the-road RRP (£)	BiK 20% (£)	CO ₂ (g/km)
DESIGN						
1.0i Turbo (105PS) S/S ecoTEC	15,000.00	3,000.00	18,000.00	18,905.00	77.90	107
1.4i Turbo (125PS) S/S	15,250.00	3,050.00	18,300.00	19,225.00	88.65	122
1.4i Turbo (150PS) S/S auto	16,375.00	3,275.00	19,650.00	20,575.00	101.73	130
Diesel						
1.6CDTi (110PS) S/S ecoTEC	16,208.33	3,241.67	19,450.00	20,375.00	97.38	107
1.6CDTi (136PS) S/S	16,783.33	3,356.67	20,140.00	21,105.00	107.67	116
TECH LINE NAV						
1.0i Turbo (105PS) S/S ecoTEC	15,583.33	3,116.67	18,700.00	19,605.00	80.82	107
1.4i Turbo (125PS) S/S	15,833.33	3,166.67	19,000.00	19,925.00	91.92	122
1.4i Turbo (150PS) S/S auto	16,958.33	3,391.67	20,350.00	21,275.00	105.23	130
Diesel						
1.6CDTi (110PS) S/S ecoTEC	16,791.67	3,358.33	20,150.00	21,075.00	100.77	107
1.6CDTi (136PS) S/S	17,366.67	3,473.33	20,840.00	21,805.00	111.28	116
1.6CDTi (136PS) S/S auto	18,466.67	3,693.33	22,160.00	23,125.00	121.92	122
GRIFFIN (SPECIAL EDITION MODEL)						
1.4i Turbo (150PS)						138
1.4i Turbo (150PS) S/S						125
1.4i Turbo (150PS) S/S auto	PRICE AVAILABLE ON REQUEST FROM RETAILER					139
Diesel						
1.6CDTi (136PS) S/S						121
SRI						
1.0i Turbo (105PS) S/S ecoTEC	17,383.33	3,476.67	20,860.00	21,765.00	93.42	110
1.4i Turbo (150PS) S/S	17,841.67	3,568.33	21,410.00	22,335.00	103.17	123
1.4i Turbo (150PS) S/S auto	18,758.33	3,751.67	22,510.00	23,475.00	116.03	134
Diesel						
1.6CDTi (110PS) S/S ecoTEC	18,591.67	3,718.33	22,310.00	23,235.00	115.03	110
1.6CDTi (136PS) S/S	19,166.67	3,833.33	23,000.00	23,965.00	122.43	118
1.6CDTi (136PS) S/S auto	20,266.67	4,053.33	24,320.00	25,285.00	137.60	126

Colours and model variants for Griffin special edition subject to availability. Please check with your Vauxhall Retailer.

S/S = Start/Stop.

All diesel models feature BlueInjection. Vehicles with BlueInjection technology will need regular AdBlue® top-ups also between servicing requirements. An indicator integrated into the on-board computer will warn you when you need to top up. More information see www.vauxhall.co.uk/adblue. In accordance with regulations R (EC) No. 715/2007 and R (EC) No. 692/2008 (in the versions respectively applicable).

Please note: On-the-road recommended retail prices (RRP) include number plates and delivery to retailer of £700.00 (inc. £116.67 VAT), 12 months' Vehicle Excise Duty and new vehicle first registration fee of £55.00. Excludes fuel and insurance.

Company Car Benefit in Kind (BiK) rates are monthly based on the standard paint price.

	Price (£)	VAT (£)	Total (£)	On-the-road RRP (£)	BiK 20% (£)	CO ₂ (g/km)
SRI NAV						
1.0i Turbo (105PS) S/S ecoTEC	17,966.67	3,593.33	21,560.00	22,465.00	96.45	110
1.4i Turbo (150PS) S/S	18,425.00	3,685.00	22,110.00	23,035.00	106.43	123
1.4i Turbo (150PS) S/S auto	19,341.67	3,868.33	23,210.00	24,175.00	119.53	134
Diesel						
1.6CDTi (110PS) S/S ecoTEC	19,175.00	3,835.00	23,010.00	23,935.00	118.53	110
1.6CDTi (136PS) S/S	19,750.00	3,950.00	23,700.00	24,665.00	126.05	118
1.6CDTi (136PS) S/S auto	20,850.00	4,170.00	25,020.00	25,985.00	141.45	126
SRI VX-LINE						
1.4i Turbo (150PS) S/S	18,841.67	3,768.33	22,610.00	23,535.00	112.65	125
Diesel						
1.6CDTi (136PS) S/S	20,166.67	4,033.33	24,200.00	25,165.00	132.78	121
SRI VX-LINE NAV						
1.4i Turbo (150PS) S/S	19,425.00	3,885.00	23,310.00	24,235.00	116.03	125
Diesel						
1.6CDTi (136PS) S/S	20,750.00	4,150.00	24,900.00	25,865.00	136.52	121
ELITE NAV						
1.0i Turbo (105PS) S/S ecoTEC	18,350.00	3,670.00	22,020.00	22,925.00	98.45	110
1.4i Turbo (150PS) S/S	18,808.33	3,761.67	22,570.00	23,495.00	108.58	123
1.4i Turbo (150PS) S/S auto	19,725.00	3,945.00	23,670.00	24,635.00	121.83	134
Diesel						
1.6CDTi (110PS) S/S ecoTEC	19,558.33	3,911.67	23,470.00	24,395.00	120.83	110
1.6CDTi (136PS) S/S	20,133.33	4,026.67	24,160.00	25,125.00	128.43	118
1.6CDTi (136PS) S/S auto	21,233.33	4,246.67	25,480.00	26,445.00	143.98	126
ULTIMATE						
1.4i Turbo (150PS) S/S	21,141.67	4,228.33	25,370.00	26,295.00	126.00	125
1.4i Turbo (150PS) S/S auto	22,058.33	4,411.67	26,470.00	27,435.00	140.37	139

ASTRA SPORTS TOURER PRICES

	Price (£)	VAT (£)	Total (£)	On-the-road RRP (£)	BiK 20% (£)	CO ₂ (g/km)
DESIGN						
1.0i Turbo (105PS) S/S ecoTEC	16,208.33	3,241.67	19,450.00	20,355.00	83.95	107
1.4i Turbo (125PS) S/S	16,458.33	3,291.67	19,750.00	20,675.00	95.42	124
Diesel						
1.6CDTi (110PS) S/S ecoTEC	17,416.67	3,483.33	20,900.00	21,865.00	107.98	112
1.6CDTi (136PS) S/S	17,991.67	3,598.33	21,590.00	22,555.00	115.15	118
TECH LINE NAV						
1.0i Turbo (105PS) S/S ecoTEC	16,791.67	3,358.33	20,150.00	21,055.00	86.87	107
1.4i Turbo (125PS) S/S	17,041.67	3,408.33	20,450.00	21,375.00	98.68	124
Diesel						
1.6CDTi (110PS) S/S ecoTEC	18,000.00	3,600.00	21,600.00	22,565.00	111.48	112
1.6CDTi (136PS) S/S	18,575.00	3,715.00	22,290.00	23,255.00	118.77	118
SRI						
1.4i Turbo (150PS) S/S	19,050.00	3,810.00	22,860.00	23,785.00	113.87	125
1.4i Turbo (150PS) S/S auto	19,966.67	3,993.33	23,960.00	24,925.00	123.28	134
Diesel						
1.6CDTi (110PS) S/S ecoTEC	19,800.00	3,960.00	23,760.00	24,725.00	126.37	116
1.6CDTi (136PS) S/S	20,375.00	4,075.00	24,450.00	25,415.00	134.12	121
1.6CDTi (136PS) S/S auto	21,475.00	4,295.00	25,770.00	26,735.00	149.98	130

	Price (£)	VAT (£)	Total (£)	On-the-road RRP (£)	BiK 20% (£)	CO ₂ (g/km)
SRI NAV						
1.4i Turbo (150PS) S/S	19,633.33	3,926.67	23,560.00	24,485.00	117.25	125
1.4i Turbo (150PS) S/S auto	20,550.00	4,110.00	24,660.00	25,625.00	126.78	134
Diesel						
1.6CDTi (110PS) S/S ecoTEC	20,383.33	4,076.67	24,460.00	25,425.00	129.98	116
1.6CDTi (136PS) S/S	20,958.33	4,191.67	25,150.00	26,115.00	137.85	121
1.6CDTi (136PS) S/S auto	22,058.33	4,411.67	26,470.00	27,435.00	153.95	130
ELITE NAV						
1.4i Turbo (150PS) S/S	20,016.67	4,003.33	24,020.00	24,945.00	119.47	125
1.4i Turbo (150PS) S/S auto	20,933.33	4,186.67	25,120.00	26,085.00	129.08	134
Diesel						
1.6CDTi (110PS) S/S ecoTEC	20,766.67	4,153.33	24,920.00	25,885.00	132.37	116
1.6CDTi (136PS) S/S	21,341.67	4,268.33	25,610.00	26,575.00	140.32	121
1.6CDTi (136PS) S/S auto	22,441.67	4,488.33	26,930.00	27,895.00	156.57	130

Colours and model variants for Griffin special edition subject to availability. Please check with your Vauxhall Retailer.

S/S = Start/Stop.

All diesel models feature BlueInjection. Vehicles with BlueInjection technology will need regular AdBlue® top-ups also between servicing requirements. An indicator integrated into the on-board computer will warn you when you need to top up. More information see www.vauxhall.co.uk/adblue. In accordance with regulations R (EC) No. 715/2007 and R (EC) No. 692/2008 (in the versions respectively applicable).

Please note: On-the-road recommended retail prices (RRP) include number plates and delivery to retailer of £700.00 (inc. £116.67 VAT), 12 months' Vehicle Excise Duty and new vehicle first registration fee of £55.00. Excludes fuel and insurance. Company Car Benefit in Kind (BiK) rates are monthly based on the standard paint price.

STANDARD FEATURES

ALL MODELS

Driver/passenger airbags

- Driver's airbag • Front passenger's airbag • Two front seat side-impact airbags
 - Full-size curtain airbags for driver and front and outer rear seat passengers
-

Seating

- Height-adjustable front seat head restraints • Three height adjustable rear seat head restraints
 - Anti-submarining ramps in all seats – Prevents occupants sliding underneath the lap belt during a collision.
-

Seatbelts

- Height adjustable front inertia-reel lap and diagonal seatbelts
 - Three inertia-reel lap and diagonal rear seatbelts • Front seatbelts with crash locking tongues
 - Outer rear seatbelt pretensioner system – Pretensioners tighten the seatbelt in the event of an accident limiting forward movement.
 - Front and outer rear seatbelt force limiters – Reduces potential upper body injuries during a frontal impact.
 - Front and rear 'seatbelt unfastened' audible warning and warning light
-

Child safety

- Deactivation switch for front passenger's airbag – Permits the safe use of a child seat in the front passenger seat.
 - ISOFIX child seat mountings incorporating top tether anchor points located on outer rear seats (does not include child seat) – Allows ISOFIX child safety seats to be securely fixed into the car. The ISOFIX mounting system reduces forward movement in an accident and makes the child seat easier to install.
 - Child-proof locks on rear doors
-

Driver/passenger safety

- Energy-absorbing steering column • Pedal release system – Reduces potential injury to the driver's legs and feet during a severe frontal impact.
 - Laminated windscreen • Side-impact protection beams • Reinforced passenger safety cell
 - Deformation zones front and rear • Burst-proof door locks and anti-jam door design
-

Pedestrian safety

- Bonnet/headlight/wiper structure – Designed to reduce pedestrian head and upper body injuries.
 - Upper and lower bumper design – Reduces upper and lower leg injuries.
-

Stability

- Electronic Stability Programme (ESP) – Works in conjunction with the vehicle's electronic braking and engine systems to keep the car stable in many different situations. ESP monitors many different inputs to determine when the car starts to lose traction, it can then immediately respond by varying the brake pressure between up to three wheels and adjust the engine output to help correct the loss of traction and improve stability.

Additional ESP features:

- Traction control • Cornering brake control • Straight line stability control • Rollover mitigation
 - Drag torque control – Maintain stability on slippery roads when lifting off the accelerator or changing gear.
-

Braking

- Anti-lock Braking System (ABS) – Prevents the vehicle's wheels from locking up under heavy braking by momentarily reducing brake pressure at the appropriate wheel, ensuring that you can maintain control of the steering.

Additional ESP features:

The same electronic systems used in the ABS and ESP also deliver exceptional braking performance.

- Emergency brake assist – When emergency braking is detected the vehicle automatically applies the maximum possible braking assistance.
 - Hazard warning lights • Fading brake support – Compensates for the effects of brake fade.
 - Electronic brakeforce distribution – Automatically apportions the optimum braking force to each wheel.
 - Adaptive brake lights – Automatically warns other road users of heavy braking.
 - Hill start assist – Briefly maintains rear brake pressure to stop the vehicle rolling back on an incline.
-

Tyre pressure

- Deflation detection system
-

STANDARD FEATURES

ALL MODELS

Cruise control with speed limiter

Cruise control enables you to maintain a constant speed – making it ideal for economical motorway driving. The speed limiter function can be set to ensure that you do not exceed the speed limit and can be easily overridden if required.

- Steering wheel mounted controls
-

Steering

- Speed sensitive electrically assisted power steering
-

Security features

- ‘Key left in ignition’ audible warning
 - Electronically protected audio equipment
 - Engine deadlock immobiliser
 - Visible Vehicle Identification Number (VIN)
 - Locking wheel bolts for alloy wheels
 - Freewheeling door locks
-

Remote control central locking

- Operates on doors, tailgate and fuel filler flap
 - Deadlocking
 - Central locking activation switch on facia
 - One folding key/one static key each with integral remote control function
-

Instrumentation

- Speedometer
 - Rev counter
 - Digital fuel gauge with low fuel level warning light
 - Digital water temperature gauge with warning light
 - Shift-up/down indication light – Indicates when to change gear for optimum fuel economy.
-

Driver information display (centrally located in instrument cluster)

- Monochrome display (upgraded to colour on Elite Nav and Ultimate models)
 - Displays trip computer data
 - Total mileage
 - Service-due indicator
 - Oil life
 - Tyre pressure monitoring system
-

Multi-function trip computer (displayed on driver information display)

- Trip mileage
 - Vehicle range based on remaining fuel
 - Average speed
 - Average fuel economy
 - Instantaneous fuel economy
 - Driving time
-

Central facia display (format dependent on infotainment unit)

- Digital clock with automatic RDS time adjustment
 - Outside air temperature with ice warning function
 - Audio information
 - Additional features dependent on infotainment unit (see infotainment for details)
-

Seating and comfort

- Reach and rake adjustable steering
 - Steering wheel mounted audio controls
 - Three person layout
 - Three height-adjustable and removable head restraints
 - ISOFIX child seat mountings incorporating top tether anchor points located on outer rear seats (does not include child seat) – Allows ISOFIX child safety seats to be securely fixed into the car. The ISOFIX mounting system reduces forward movement in an accident and makes the child seat easier to install.
 - Child-proof locks on rear doors
-

Heating and ventilation

- Four adjustable facia vents
 - Windscreen demist vents
 - Side window demist vents
 - Heated rear screen with timed cut-off
-

Convenience features

- Front 12-volt electrical accessory socket
 - Driver’s and front passengers sunvisors
 - Front passenger vanity mirror
 - Dipping rear-view mirror
-

Interior lighting

- Central front courtesy light
 - Central rear courtesy light
 - Fade up/fade down
-

Interior storage

- Fold out storage box on driver’s side lower facia
 - Glovebox with lid
 - Front door pockets
 - Two drinks holders in centre console
 - Rear door pockets
 - Storage compartment in centre console
-

Luggage area

- Luggage compartment cover (Hatchback only)
 - Luggage compartment retractable cover (Sports Tourer only)
 - Illuminated load area
 - Fully carpeted load area
 - Interior tailgate handle
 - Four load restraint lashing eyes
 - Twin gas-assisted tailgate struts
-

STANDARD FEATURES

ALL MODELS

Exterior lighting features

- LED daytime running lights
 - Automatic lighting control: When the automatic lighting control is switched on, the system switches between daytime running lights and headlights automatically depending on external lighting conditions.
 - Halogen projector headlights • LED side repeat indicators
 - Lights-on audible warning – When keys are removed and driver door opened an audible warning sounds to alert the lights have been left on.
 - Manual headlight beam levelling – Use to adapt headlight range to the vehicle load to prevent dazzling.
 - High-level LED centre rear brake light • Rear fog light • Reversing light • Hazard warning lights
 - Door-to-door illumination: Headlights illuminate the area for an adjustable time after leaving the vehicle.
-

Windscreen wipers

- Two-speed windscreen wipers with variable intermittent wipe • Intermittent rear window wash/wipe
-

Windows

- Electrically operated front and rear windows with safety autoreverse and one-touch up/down facility
 - Heated rear window • Solar heat-absorbing windscreen • Tinted windows
-

Body styling

- Chrome-effect front grille bar • Chrome-effect headlight detail • Body-colour door handles
 - Body-colour door mirrors • Body-colour rear roof spoiler
-

FEATURES/OPTIONS

DRIVER ASSISTANCE

	Design	Tech Line Nav	Griffin	SRI	SRI VX-Line	Elite Nav	Ultimate	Price (£) exc. VAT	Price (£) inc. VAT
Front and rear parking distance sensors • Front and rear parking distance sensors • Audible warning • Distance warning graphic shown in driver information display	○	○		○	○	○		400.00	480.00
Parking Pack (includes front and rear parking distance sensors) Intelligent ultrasonic sensors form part of the solution for today's crowded roads and car parks – delivering exceptional assistance both when parking and protecting you on the open road. Advanced park assist Advanced park assist not only detects suitable parking spaces but also expertly steers into them for you. All you have to do is to drive forward or reverse and apply the brakes. The system works with both parallel and bay parking. • Ultrasonic side sensors with four-metre range • Ultrasonic front and rear parking sensors with a two-metre range • Fully automated steering • Detailed forward/reverse instructions are shown in the instrument cluster Side blind spot alert Side blind spot alert helps prevent potential collisions with other vehicles 'hidden' in the vehicle's side blind spots. If a vehicle enters one of the blind spots a warning light illuminates in the relevant door mirror. • Ultrasonic side sensors with three-metre range • LED warning light in door mirrors • Audible warning is sounded if the indicators are used and the system has detected another vehicle • Electrically folding door mirrors (fitted as standard on Elite Nav models) Rear-view camera The rear-view camera gives a clear view of the area behind your car and helps place the car perfectly, without needing to strain your neck. • Activated when reverse gear selected • Camera view appears in infotainment screen • Rear bumper and one-metre grid lines shown as reference points				○	○	○	●	625.00	750.00
Sport switch Enables the driver to change the steering feel and throttle response for a sportier driving style. • Facia mounted sport switch				●	●				
Electric parking brake • Centre console switch in lieu of handbrake lever • Premium centre console featuring adjustable armrest			●	○	○	●	●	195.83	235.00

● = Standard equipment. ○ = Optional at extra cost.

FEATURES/OPTIONS

DRIVER ASSISTANCE CONTINUED

	Design	Tech Line Nav	Griffin	SRI	SRI VX-Line	Elite Nav	Ultimate	Price (£) exc. VAT	Price (£) inc. VAT
<p>Driving Assistance Pack One</p> <p>A wide range of class-leading driver assistance and safety features are controlled by the front camera system.</p> <p>Forward collision alert with automatic city emergency braking In certain circumstances and at speeds above 5mph warns when approaching another vehicle too quickly. At speeds above 5mph and up to 53mph the system provides additional braking support to help the driver brake more quickly and effectively in an emergency situation. At speeds above 5mph and up to 37mph if no avoiding action is taken by the driver, the system automatically slows the vehicle with emergency braking.</p> <ul style="list-style-type: none"> • Visual warnings – shown in the instrument cluster • Audible warning • Additional braking support • Low speed collision mitigation braking <p>Traffic sign recognition Detects and then displays speed limits, reducing uncertainty and the risk of speeding.</p> <ul style="list-style-type: none"> • Recognises different road signs, including temporary speed restrictions • Displays reminder in the driver information centre <p>Following distance indicator Indicates how many seconds you are behind the vehicle in front – helping you maintain a safe distance.</p> <ul style="list-style-type: none"> • Timings are shown in the driver information centre <p>Lane departure warning with lane assist If the driver has not actively steered or signalled, the lane departure warning system warns when the car moves outside of lane markings at speeds above 35mph. The lane keep assist function additionally provides gentle steering correction to help drivers keep in their lane if no active inputs are made.</p> <ul style="list-style-type: none"> • Warning light in the instrument cluster • Audible warning • Steering wheel ‘nudge’ warning • Facia on/off switch • Both systems switch to standby when in road works or when road markings are confused <p>Please note: Design and Tech Line Nav models are upgraded to include</p> <ul style="list-style-type: none"> • Twin front reading lights with illuminated switches • Twin rear reading lights with illuminated switches • Ambient LED facia/centre console downlighter • Driver’s and front passenger’s illuminated vanity mirrors with flip-up covers • Automatic lighting control with tunnel detection • Automatically dimming anti-dazzle rear-view mirror • Rain-sensitive windscreen wipers 									
	○	○		●	●			679.17	815.00
						○	●	479.17	575.00

● = Standard equipment. ○ = Optional at extra cost.

FEATURES/OPTIONS

SECURITY

	Design	Tech Line Nav	Griffin	SRi	SRi VX-Line	Elite Nav	Ultimate	Price (£) exc. VAT	Price (£) inc. VAT
<p>Remote control ultrasonic security alarm system</p> <ul style="list-style-type: none"> • Remote control (operates in conjunction with central locking) • Ultrasonic interior sensors • Tilt sensor • Thatcham approved <p>Please note: Design and Tech Line Nav models are upgraded to include • Twin front reading lights with illuminated switches</p> <ul style="list-style-type: none"> • Twin rear reading lights with illuminated switches • Ambient LED facia/centre console downlighter • Driver's and front passenger's illuminated vanity mirrors with flip-up covers <p>Alarm system is standard on Tech Line Nav 1.6 (136PS) Turbo D S/S manual models, and optional on SRi 1.0 (105PS) Turbo S/S ecoTEC models, standard on all other SRi models.</p>	○	○	●	●	●	●	●	216.67	260.00

INTERIOR STYLING

<p>Design interior décor</p> <p>Steering wheel:</p> <ul style="list-style-type: none"> • Three-spoke design • Satin chrome-effect bezel <p>Facia and door trim:</p> <ul style="list-style-type: none"> • Black facia with Antelao Sand trim inserts • Instrument panel bar Polar Silver • Black door panels with black Atlantis cloth inserts • Polar Silver trim inserts on front doors • Chrome-effect interior door handles <p>Seat trim:</p> <ul style="list-style-type: none"> • Talino fabric seat trim inserts • Plain black fabric side bolsters and surrounds <p>Headlining:</p> <ul style="list-style-type: none"> • Titanium roof lining 	●								
<p>Tech Line Nav interior décor</p> <p>Steering wheel:</p> <ul style="list-style-type: none"> • Three-spoke design • Leather-covered with accent stitching • Satin chrome-effect bezel <p>Facia and door trim:</p> <ul style="list-style-type: none"> • Black facia with Antelao Sand trim inserts • Instrument panel bar Polar Silver • Black door panels with black Atlantis cloth inserts • Polar Silver trim inserts on front doors • Chrome-effect interior door handles <p>Seat trim:</p> <ul style="list-style-type: none"> • Talino fabric seat trim inserts • Plain black fabric side bolsters and surrounds <p>Headlining:</p> <ul style="list-style-type: none"> • Titanium roof lining 		●							

● = Standard equipment. ○ = Optional at extra cost.

FEATURES/OPTIONS

INTERIOR STYLING CONTINUED

	Design	Tech Line Nav	Griffin	SRi	SRi VX-Line	Elite Nav	Ultimate	Price (£) exc. VAT	Price (£) inc. VAT
<p>Griffin interior décor</p> <p>Steering wheel:</p> <ul style="list-style-type: none"> • Three-spoke design • Leather covered with accent stitching • Satin chrome-effect bezel <p>Facia and door trim:</p> <ul style="list-style-type: none"> • Black facia with Piano black trim inserts • Instrument panel bar Satin Chrome • Silver air vent surrounds • Black door panels with black Sienna cloth inserts • Piano black trim inserts on front doors • Chrome-effect interior door handles <p>Seat trim:</p> <ul style="list-style-type: none"> • Athena fabric seat trim inserts • Premium leather-effect side bolsters and surrounds <p>Headlining:</p> <ul style="list-style-type: none"> • Titanium roof lining <p>Front door sill covers:</p> <ul style="list-style-type: none"> • Alloy-effect 			●						
<p>SRi/SRi VX-Line interior décor</p> <p>Steering wheel:</p> <ul style="list-style-type: none"> • Three-spoke design • Leather-covered with accent stitching • Satin chrome-effect bezel <p>Facia and door trim:</p> <ul style="list-style-type: none"> • Black facia with Piano black trim inserts • Instrument panel bar Piano Black • Silver air vent surrounds • Black door panels with black Atlantis cloth inserts • Piano black trim inserts on front doors • Chrome-effect interior door handles <p>Seat trim:</p> <ul style="list-style-type: none"> • Formula fabric seat trim inserts • Plain black fabric side bolsters and surrounds <p>Headlining:</p> <ul style="list-style-type: none"> • SRi models – Titanium roof lining • SRi VX-Line models – Black roof lining 				●	●				

● = Standard equipment.

FEATURES/OPTIONS

INTERIOR STYLING CONTINUED

	Design	Tech Line Nav	Griffin	SRI	SRI VX-Line	Elite Nav	Ultimate	Price (£) exc. VAT	Price (£) inc. VAT
<p>Elite Nav/Ultimate interior décor with Siena leather seat trim</p> <p>Steering wheel:</p> <ul style="list-style-type: none"> • Three-spoke design • Leather-covered with accent stitching • Satin chrome-effect bezel <p>Facia and door trim:</p> <ul style="list-style-type: none"> • Black facia with Piano black trim inserts • Instrument panel bar Satin Chrome • Silver air vent surrounds • Black door panels with black Leather-effect inserts • Piano black trim inserts on front doors • Chrome-effect interior door handles <p>Seat trim:</p> <ul style="list-style-type: none"> • Black Siena leather seat trim inserts • Black leather-effect side bolsters and surrounds <p>Headlining:</p> <ul style="list-style-type: none"> • Titanium roof lining <p>Front door sill covers:</p> <ul style="list-style-type: none"> • Alloy-effect 						●	●		

SEATING AND COMFORT

<p>Comfort front seats</p> <p>Driver's seat (eight way adjustable):</p> <ul style="list-style-type: none"> • Height (up/down) • Reach (fore/aft) • Backrest recline (upright/incline) • Head restraint (up/down) <p>Front passenger's seat (six way adjustable):</p> <ul style="list-style-type: none"> • Reach (fore/aft) • Backrest (upright/recline) • Head restraint (up/down) 	●	●							
<p>Driver's ergonomic active seat – AGR certified* with sports-style front passenger seat</p> <p>Driver's seat (16-way adjustable):</p> <ul style="list-style-type: none"> • Height (up/down) • Reach (fore/aft) • Tilt (fore/aft) • Backrest (upright/recline) • Seat cushion extension (fore/aft) • Lumbar adjustment (four-way electrical) • Head restraint (up/down) <p>Front passenger's seat (six way adjustable):</p> <ul style="list-style-type: none"> • Reach (fore/aft) • Backrest (upright/recline) • Head restraint (up/down) 	○	○	●	●	●			216.67	260.00

● = Standard equipment. ○ = Optional at extra cost.

FEATURES/OPTIONS

SEATING AND COMFORT CONTINUED

	Design	Tech Line Nav	Griffin	SRI	SRI VX-Line	Elite Nav	Ultimate	Price (£) exc. VAT	Price (£) inc. VAT
Sports-style front seats featuring Siena Leather Driver's and front passenger's seat (12-way adjustable): • Height (up/down) • Reach (fore/aft) • Backrest (upright/recline) • Lumbar adjustment (four-way electrical) • Head restraint (up/down)						●			
• Heated front and outer rear seats						●			
• Heated front and outer rear seats • Centre rear armrest							●		
Driver's and front passenger's ergonomic active seats – AGR certified* – Changes seat trim to perforated leather on Elite Nav models Driver's and front passenger's seat (16-way adjustable): • Height (up/down) • Reach (fore/aft) • Tilt (fore/aft) • Backrest (upright/recline) • Seat cushion extension (fore/aft) • Lumbar adjustment (four-way electrical) • Head restraint (up/down)						○	●	170.83	205.00
Driver's Ergonomic Active Seat with Wellness Functions – AGR certified* (only available with optional driver's & front passenger's ergonomic active seats – AGR certified) Driver's seat additional features: • Massage function via three air cushions • Active ventilation backrest/seat cushion • Electrically operated adjustment with seat memory function • Pneumatically adjustable backrest side bolsters Front passenger's seat additional feature: • Active ventilation backrest/seat cushion						○	○	595.83	715.00
Rear seating • 60/40 split-folding rear seat back	●	●	●	●	●	●			
• 40/20/40 split-folding rear seat back • FlexFold rear seats with remote electrical release (Sports Tourer only) • Leather trim only							●		

*AGR (The Campaign for Healthier Backs) is an independent centre of excellence for ergonomics, based in Germany.

● = Standard equipment. ○ = Optional at extra cost.

FEATURES/OPTIONS

INFOTAINMENT

	Design	Tech Line Nav	Griffin	SRi	SRi VX-Line	Elite Nav	Ultimate	Price (£) exc. VAT	Price (£) inc. VAT
<p>R4.0 IntelliLink touchscreen infotainment system</p> <p>For use with MP3 players, USB memory sticks, mobile phones and smartphone apps</p> <p>Onboard features:</p> <ul style="list-style-type: none"> • 7-inch colour touchscreen • DAB digital radio/AM/FM stereo radio with 36 station presets • RDS with Traffic Programme <p>Media connections:</p> <ul style="list-style-type: none"> • USB connection with iPod control • Bluetooth® A2DP audio streaming (Advanced Audio Distribution Profile) <p>Mobile phone portal:</p> <ul style="list-style-type: none"> • Bluetooth® connectivity • Handsfree calls via steering wheel controls • Vehicle microphone • Phone book access – Contacts/last calls/missed calls etc. are mirrored on IntelliLink’s display and are easily navigated using the touchscreen (features dependent on mobile phone). <p>Smartphone interface:</p> <ul style="list-style-type: none"> • Apple CarPlay™ • Android Auto™ – Smartphone projection that allows operations via voice command, touchscreen and buttons to control apps and music playback. 	●			●	●				
<p>Navi R4.0 IntelliLink touchscreen navigation and infotainment system</p> <p>For use with MP3 players, USB memory sticks, mobile phones and smartphone apps</p> <p>Onboard features:</p> <ul style="list-style-type: none"> • 7-inch colour touchscreen • DAB digital radio/AM/FM stereo radio with 36 station presets • RDS with Traffic Programme <p>Navigation features:</p> <ul style="list-style-type: none"> • Satellite navigation system <p>Media connections:</p> <ul style="list-style-type: none"> • USB connection with iPod control • Bluetooth® A2DP audio streaming (Advanced Audio Distribution Profile) <p>Mobile phone portal:</p> <ul style="list-style-type: none"> • Bluetooth® connectivity • Handsfree calls via steering wheel controls • Vehicle microphone • Phone book access – Contacts/last calls/missed calls etc. are mirrored on IntelliLink’s display and are easily navigated using the touchscreen (features dependent on mobile phone). <p>Smartphone interface:</p> <ul style="list-style-type: none"> • Apple CarPlay™ • Android Auto™ – Smartphone projection that allows operations via voice command, touchscreen and buttons to control apps and music playback. 		●	●	▲	▲				

● = Standard equipment. ▲ = Standard on Nav models, see pricing page for details.

FEATURES/OPTIONS

INFOTAINMENT CONTINUED

	Design	Tech Line Nav	Griffin	SRI	SRI VX-Line	Elite Nav	Ultimate	Price (£) exc. VAT	Price (£) inc. VAT
<p>Navi 900 IntelliLink touchscreen navigation and infotainment system</p> <p>For use with MP3 players, USB memory sticks, mobile phones and smartphone apps</p> <p>Onboard features:</p> <ul style="list-style-type: none"> • 8-inch colour touchscreen • DAB digital radio/AM/FM stereo radio with 36 station presets • RDS with Traffic Programme • 60 configurable favourites including contacts, addresses, playlists, radio stations and voice recognition • Six premium speakers <p>Navigation features:</p> <ul style="list-style-type: none"> • Satellite navigation system • 3D street level mapping • European coverage <p>Media connections:</p> <ul style="list-style-type: none"> • USB connection with iPod control • Bluetooth® A2DP audio streaming (Advanced Audio Distribution Profile) <p>Mobile phone portal:</p> <ul style="list-style-type: none"> • Bluetooth® connectivity • Handsfree calls via steering wheel controls • Vehicle microphone • Phone book access – Contacts/last calls/missed calls etc. are mirrored on IntelliLink's display and are easily navigated using the touchscreen (features dependent on mobile phone). <p>Smartphone interface:</p> <ul style="list-style-type: none"> • Apple CarPlay™ • Android Auto™ – Smartphone projection that allows operations via voice command, touchscreen and buttons to control apps and music playback. 						●	●	591.67	710.00
CD drive (only available in conjunction with Navi 900 IntelliLink)						○	○	112.50	135.00
Four speakers (front)	●	●							
Six speakers (four front, two rear)			●	●	●	●	●		
Twin USB power sockets for rear seat passengers						●	●		

● = Standard equipment. ○ = Optional at extra cost.

FEATURES/OPTIONS

HEATING AND VENTILATION

	Design	Tech Line Nav	Griffin	SRI	SRI VX-Line	Elite Nav	Ultimate	Price (£) exc. VAT	Price (£) inc. VAT
Air conditioning • Air recirculation facility • Cabin particulate filter – Removes dust, airborne particles and pollen. • Multi-speed fan • Illuminated controls	●	●		●	●				
Electronic climate control including air conditioning • Dual-zone control – Allowing different temperature settings for driver and front passenger. • Advanced predictive logic control system using sun and humidity sensors • Partial air recirculation – Faster warm up/cool down. • Cabin particulate filter – Removes dust, airborne particles and pollen. • Automatic air direction and fan speed with manual override • LCD temperature display • Illuminated controls			●	○	○	●	●	354.17	425.00
Winter Pack  • Heated leather-covered steering wheel • Heated front seats – Three temperature settings. • Rear floor heating ducts	○	○	●	○	○	●	●	295.83	355.00

INTERIOR CONVENIENCE/LIGHTING

Automatically dimming anti-dazzle rear-view mirror			●	●	●	●	●		
Front centre armrest with storage		●	●	●	●	●	●		
Twin USB power sockets for rear seat passengers – each socket provides 2.1 amps at 5 volts						●	●		
Premium lighting • Twin front reading lights with illuminated switches • Twin rear reading lights with illuminated switches • Ambient LED facia/centre console downlighter • Driver's and front passenger's illuminated vanity mirrors with flip-up covers			●	●	●	●	●		
• Ambient LED lighting in front doors			●			●	●		
Interior storage • Storage pockets on front seat backs			●	●	●	●	●		

● = Standard equipment. ○ = Optional at extra cost.

FEATURES/OPTIONS

EXTERIOR LIGHTING

	Design	Tech Line Nav	Griffin	SRi	SRi VX-Line	Elite Nav	Ultimate	Price (£) exc. VAT	Price (£) inc. VAT
Standard lighting features <ul style="list-style-type: none"> • Automatic lighting control with tunnel detection 			●	●	●	●	●		
IntelliLux LED Matrix headlights <p>IntelliLux LED Matrix headlights work with the Driving Assistance Pack One incorporating front camera system, to provide outstanding lighting performance and enhanced safety. Each headlight features a matrix of eight individual LED lights. These lights replace the main beam function and supplement the dipped beam function. Each LED illuminates a separate part of the road ahead meaning that by automatically switching lights on and off, illumination is varied to suit traffic and road conditions.</p> <p>The IntelliLux system calculates which LED lights are activated and deactivated using additional data such as ambient light conditions, vehicle speed, steering angle and when the indicators are used. For example, when the front camera system detects an oncoming vehicle, the individual LED lights that would dazzle the oncoming driver are automatically switched off and then switched back on once the vehicle has passed. All other areas remain fully illuminated. Studies show that the enhanced roadside illumination of IntelliLux LED Matrix headlights give the driver an extra 1.5 seconds of reaction time at 50mph.</p> <ul style="list-style-type: none"> • Dipped beam, main beam and dynamic lighting: 16 electronically controlled LED lights (eight per headlight) • Driving Assistance Pack One incorporating front camera system • Intelligent main beam control • Automatic headlight levelling • LED tail lights 				○	○		●	1,041.67	1,250.00
Every type of driving environment has been considered: <ul style="list-style-type: none"> • Urban light – With street lighting and speeds up to 34mph, the system automatically enhances the dipped beam function. • Highway light – The system recognises when the car is on a dual carriageway or motorway. At higher speeds the light distribution on the right is reduced to minimise glare from the crash barriers. • Country light – As speeds increase, so does the lighting’s performance. • Static Cornering light – At lower speeds corners and bends are illuminated to match steering inputs. • Parking light – When reversing, additional side-facing lights are activated in the headlights. • Energy saving mode – On Start/Stop models, the IntelliLux LED Matrix system goes into Energy saving mode when the engine is automatically stopped. 						○		1,520.83	1,825.00
LED tail lights: (standard with IntelliLux LED Matrix headlights)				○	○	○	●	170.83	205.00
Front fog lights	●	●	●	●		●	●		

● = Standard equipment. ○ = Optional at extra cost.

FEATURES/OPTIONS

EXTERIOR CONVENIENCE/STYLING

	Design	Tech Line Nav	Griffin	SRi	SRi VX-Line	Elite Nav	Ultimate	Price (£) exc. VAT	Price (£) inc. VAT
Keyless entry and start • Two transmitter fobs • Engine Start/Stop button • Back-up key				○	○	○	○	337.50	405.00
Power tailgate • With under bumper release sensor (Sports Tourer only) – Only available in conjunction with optional keyless entry and start				○		○		300.00	360.00
Windscreen wipers • Rain-sensitive windscreen wipers			●	●	●	●	●		
Door mirrors • Twin electrically adjustable/heated door mirrors • Manually folding door mirrors	●	●		●	●				
• Electrically folding door mirrors			●			●	●		
Windows • Dark-tinted rear windows	●	●	●	○	○	○	●	237.50	285.00
Power tilt and slide sunroof • Manually operated sunblind • Sunroof can be closed remotely from outside of the vehicle Please note: Design and Tech Line Nav models are upgraded to include: • Twin front reading lights with illuminated switches • Driver's and front passenger's illuminated vanity mirrors with flip-up covers • Twin rear reading lights with illuminated switches	○	○		○	○	○	○	458.33	550.00
Roof rails (Sport Tourer only) • Black	●	●							
• Silver-effect				●		●			

● = Standard equipment. ○ = Optional at extra cost.







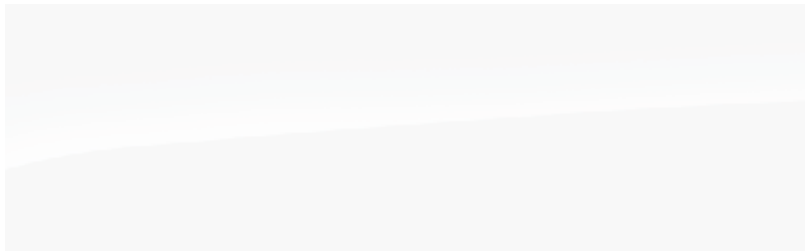

FEATURES/OPTIONS

EXTERIOR CONVENIENCE/STYLING CONTINUED

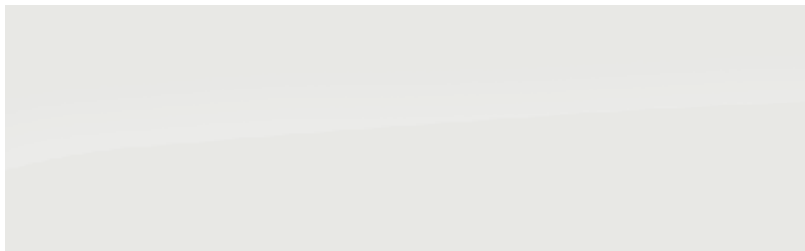
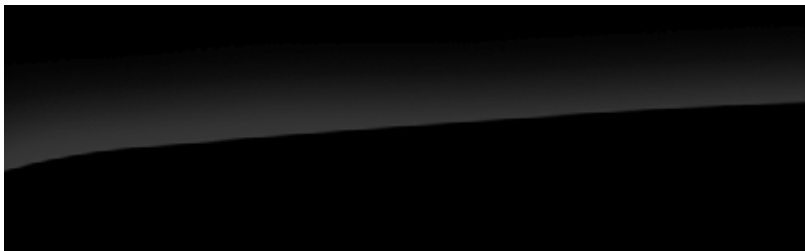
	Design	Tech Line Nav	Griffin	SRi	SRi VX-Line	Elite Nav	Ultimate	Price (£) exc. VAT	Price (£) inc. VAT
Towing Pack <ul style="list-style-type: none"> • Detachable tow bar • Trailer stability programme integrated into ESP system Please note: Not available with optional VX-Line Styling Pack on Elite Nav and Ultimate models.	○	○		○		○	○	504.17	605.00
Body styling <ul style="list-style-type: none"> • Chrome-effect upper window trim 			●	●	●	●	●		
<ul style="list-style-type: none"> • Matt black B-pillars • Gloss black C-pillars 	●	●							
<ul style="list-style-type: none"> • Gloss black B-pillars • Gloss black C-pillars 			●	●	●	●	●		
VX-Line Styling Pack (Hatchback models only) <ul style="list-style-type: none"> • Sports-style front and rear bumpers • Side sills Please note: Deletes front fog lights, not available with 1.0i Turbo (105PS) or 1.6CDTi (110PS) S/S ecoTEC models. Not available with optional Towing Pack or Aegean Blue and Flip Chip Silver exterior colours.					●	○	○	829.17	995.00

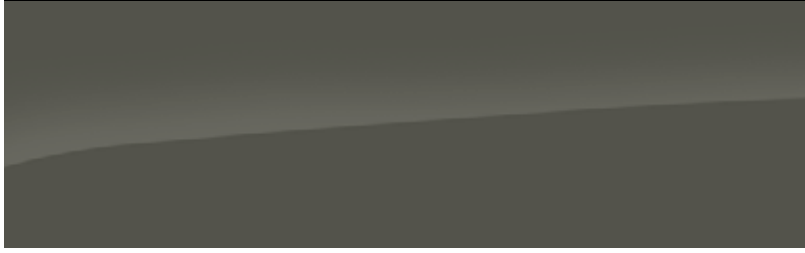
● = Standard equipment. ○ = Optional at extra cost.

EXTERIOR COLOURS



				Design	Tech Line Nav	Griffin	SRi	SRi VX-Line	Elite Nav	Ultimate	Price (£) exc. VAT	Price (£) inc. VAT
Solid		Aegean Blue		●	●	●	●		●	●		
Brilliant		Summit White		○	○	N/C	○	○	○	○	237.50	285.00
Two-coat		Sovereign Silver metallic		○	○	N/C	○	○	○	○	479.17	575.00
		Flip Chip Silver metallic • Not available on SRi VX-Line models										
Two-coat		Darkmoon Blue premium		○	○	N/C	○	○	○	○	545.83	655.00
		Emerald Green premium	Dark Caramel premium • No-cost option on SRi VX-Line models									

The colours reproduced may vary slightly from the actual paint colour. As a result they should be used as a guide only. Your Vauxhall Retailer has a comprehensive display of our paint samples.

Colours and model variants for Griffin special edition subject to availability. Please check with your Vauxhall Retailer.



● = Standard equipment. ○ = Optional at extra cost. N/C = No-cost option.

WHEELS AND TYRES

	Design	Tech Line Nav	Griffin	SRI	SRI VX-Line	Elite Nav	Ultimate	Price (£) exc. VAT	Price (£) inc. VAT
Steel emergency spare wheel (in lieu of emergency tyre inflation kit) Loadspace capacity is reduced.	○	○		○	○	○	○	91.67	110.00
Full-size 16-inch steel spare wheel (in lieu of emergency tyre inflation kit) Sports Tourer only, not available with optional 17-inch alloy wheels.	○	○						91.67	110.00
 16-inch alloy wheels <ul style="list-style-type: none"> • 205/55 R 16 tyres • Emergency tyre inflation kit (in lieu of spare wheel) 	●	●							
 16-inch structure wheels <ul style="list-style-type: none"> • 205/55 R 16 tyres • Emergency tyre inflation kit (in lieu of spare wheel) 	N/C	N/C						No-cost option	
 17-inch 10-spoke alloy wheels <ul style="list-style-type: none"> • 225/45 R 17 tyres • Emergency tyre inflation kit (in lieu of spare wheel) 	○	○						400.00	480.00



● = Standard equipment. ○ = Optional at extra cost. N/C = No-cost option.

WHEELS AND TYRES

	Design	Tech Line Nav	Griffin	SRI	SRI VX-Line	Elite Nav	Ultimate	Price (£) exc. VAT	Price (£) inc. VAT
 <p>17-inch five twin-spoke alloy wheels</p> <ul style="list-style-type: none"> • 225/45 R 17 tyres • Emergency tyre inflation kit (in lieu of spare wheel) 				●					
 <p>17-inch multi-spoke alloy wheels</p> <ul style="list-style-type: none"> • 225/45 R 17 tyres • Emergency tyre inflation kit (in lieu of spare wheel) 						●			
 <p>17-inch gloss black five twin-spoke alloy wheels</p> <ul style="list-style-type: none"> • 225/45 R 17 tyres • Emergency tyre inflation kit (in lieu of spare wheel) 				○		○		83.33	100.00

● = Standard equipment. ○ = Optional at extra cost.

WHEELS AND TYRES

	Design	Tech Line Nav	Griffin	SRi	SRi VX-Line	Elite Nav	Ultimate	Price (£) exc. VAT	Price (£) inc. VAT
 <p>18-inch bi-colour alloy wheels</p> <ul style="list-style-type: none"> • 225/40 R 18 tyres • Emergency tyre inflation kit (in lieu of spare wheel) • Not available with 1.0i Turbo (105PS) or 1.6CDTi (110PS) ecoTEC engines 			●	○		○	●	400.00	480.00
 <p>18-inch five twin-spoke alloy wheels</p> <ul style="list-style-type: none"> • 225/40 R 18 tyres • Emergency tyre inflation kit (in lieu of spare wheel) • Not available with 1.0i Turbo (105PS) or 1.6CDTi (110PS) ecoTEC engines 				○	●			400.00	480.00

● = Standard equipment. ○ = Optional at extra cost.

PERFORMANCE, FUEL ECONOMY AND EMISSIONS

HATCHBACK	Performance (manufacturer's figures)			Fuel economy mpg (litres/100km)#		CO ₂ emissions g/km*	Vehicle Excise Duty**		Benefit in kind company car taxation rates - 2019/20 tax year
	Wheel size (inches)	Maximum speed (mph)	Acceleration 0-60mph (sec)	Combined Low	Combined High		First year rate	Standard rate	
Manual									
1.0i Turbo (105PS) Start/Stop ecoTEC	16	121	10.9	44.1 (6.4)	48.7 (5.8)	107	£150	£145	25%
1.0i Turbo (105PS) Start/Stop ecoTEC	17	121	10.9	44.1 (6.4)	48.7 (5.8)	110	£150	£145	26%
1.4i Turbo (125PS) Start/Stop	16	127	8.9	44.1 (6.4)	47.9 (5.9)	122	£170	£145	28%
1.4i Turbo (125PS) Start/Stop	17	127	8.9	44.1 (6.4)	47.9 (5.9)	123	£170	£145	28%
1.4i Turbo (150PS) Start/Stop	17	134	8.0	44.1 (6.4)	47.9 (5.9)	123	£170	£145	28%
1.4i Turbo (150PS) Start/Stop	18	134	8.0	44.1 (6.4)	47.9 (5.9)	125	£170	£145	29%
1.4i Turbo (150PS) – Griffin model only	18	134	7.8	42.8 (6.6)	45.6 (6.2)	138	£210	£145	31%
1.6CDTi (110PS) Start/Stop ecoTEC BlueInjection	16	124	10.4	53.3 (5.3)	60.1 (4.7)	107	£170	£145	29%
1.6CDTi (110PS) Start/Stop ecoTEC BlueInjection	17	124	10.4	53.3 (5.3)	60.1 (4.7)	110	£170	£145	30%
1.6CDTi (136PS) Start/Stop BlueInjection	16	132	8.8	52.3 (5.4)	58.9 (4.8)	116	£210	£145	31%
1.6CDTi (136PS) Start/Stop BlueInjection	17	132	8.8	52.3 (5.4)	58.9 (4.8)	118	£210	£145	31%
1.6CDTi (136PS) Start/Stop BlueInjection	18	132	8.8	52.3 (5.4)	58.9 (4.8)	121	£210	£145	32%
Automatic									
1.4i Turbo (150PS) Start/Stop	16	130	8.2	37.7 (7.5)	42.8 (6.6)	130	£170	£145	30%
1.4i Turbo (150PS) Start/Stop	17	130	8.2	37.7 (7.5)	42.8 (6.6)	134	£210	£145	30%
1.4i Turbo (150PS) Start/Stop	18	130	8.2	37.7 (7.5)	42.8 (6.6)	139	£210	£145	31%
1.6CDTi (136PS) Start/Stop BlueInjection	16	129	9.4	48.7 (5.8)	52.3 (5.4)	122	£210	£145	32%
1.6CDTi (136PS) Start/Stop BlueInjection	17	129	9.4	48.7 (5.8)	52.3 (5.4)	126	£210	£145	33%
1.6CDTi (136PS) Start/Stop BlueInjection	18	129	9.4	48.7 (5.8)	52.3 (5.4)	130	£210	£145	34%

#Fuel consumption figures are determined according to the WLTP test cycle. Full data relating to WLTP test cycles can be found at: www.vauxhall.co.uk/wltp

*CO₂ emissions figures are determined according to the WLTP test cycle however, a Government formula is then applied to translate these figures back to what they would have been under the outgoing NEDC test cycle, which WLTP replaces. The correct tax treatment is then applied.

Figures are intended for comparability purposes only. The fuel consumption you achieve under real life driving conditions and CO₂ produced will depend upon a number of factors, including the accessories fitted after registration, variations in driving styles, weather conditions and vehicle load. Only compare fuel consumption and CO₂ with other vehicles tested using the same technical procedures. For more information contact your local Vauxhall Retailer.

**Correct at time of publication.

PERFORMANCE, FUEL ECONOMY AND EMISSIONS

SPORTS TOURER	Performance (manufacturer's figures)			Fuel economy mpg (litres/100km)#		CO ₂ emissions g/km*	Vehicle Excise Duty**		Benefit in kind company car taxation rates - 2019/20 tax year
	Wheel size (inches)	Maximum speed (mph)	Acceleration 0-60mph (sec)	Combined Low	Combined High		First year rate	Standard rate	
Manual									
1.0i Turbo (105PS) Start/Stop ecoTEC	16	121	11.1	43.5 (6.5)	48.7 (5.8)	107	£150	£145	25%
1.0i Turbo (105PS) Start/Stop ecoTEC	17	121	11.1	43.5 (6.5)	48.7 (5.8)	110	£150	£145	26%
1.4i Turbo (125PS) Start/Stop	16	127	9.3	43.5 (6.5)	47.9 (5.9)	124	£170	£145	28%
1.4i Turbo (125PS) Start/Stop	17	127	9.3	43.5 (6.5)	47.9 (5.9)	126	£170	£145	29%
1.4i Turbo (150PS) Start/Stop	17	134	8.4	43.5 (6.5)	47.9 (5.9)	125	£170	£145	29%
1.4i Turbo (150PS) Start/Stop	18	134	8.4	43.5 (6.5)	47.9 (5.9)	127	£210	£145	30%
1.6CDTi (110PS) Start/Stop ecoTEC BlueInjection	16	124	10.7	52.3 (5.4)	58.9 (4.8)	112	£210	£145	30%
1.6CDTi (110PS) Start/Stop ecoTEC BlueInjection	17	124	10.7	52.3 (5.4)	58.9 (4.8)	116	£210	£145	31%
1.6CDTi (136PS) Start/Stop BlueInjection	16	132	9.0	52.3 (5.4)	57.7 (4.9)	118	£210	£145	31%
1.6CDTi (136PS) Start/Stop BlueInjection	17	132	9.0	52.3 (5.4)	57.7 (4.9)	121	£210	£145	32%
1.6CDTi (136PS) Start/Stop BlueInjection	18	132	9.0	52.3 (5.4)	57.7 (4.9)	125	£210	£145	33%
Automatic									
1.4i Turbo (150PS) Start/Stop	17	130	8.6	37.2 (7.6)	42.8 (6.6)	134	£210	£145	30%
1.4i Turbo (150PS) Start/Stop	18	130	8.6	37.2 (7.6)	42.8 (6.6)	138	£210	£145	31%
1.6CDTi (136PS) S/S BlueInjection	17	129	9.6	47.1 (6.0)	52.3 (5.4)	130	£210	£145	34%
1.6CDTi (136PS) S/S BlueInjection	18	129	9.6	47.1 (6.0)	52.3 (5.4)	134	£530	£145	34%

#Fuel consumption figures are determined according to the WLTP test cycle. Full data relating to WLTP test cycles can be found at: www.vauxhall.co.uk/wltp

*CO₂ emissions figures are determined according to the WLTP test cycle however, a Government formula is then applied to translate these figures back to what they would have been under the outgoing NEDC test cycle, which WLTP replaces. The correct tax treatment is then applied.

Figures are intended for comparability purposes only. The fuel consumption you achieve under real life driving conditions and CO₂ produced will depend upon a number of factors, including the accessories fitted after registration, variations in driving styles, weather conditions and vehicle load. Only compare fuel consumption and CO₂ with other vehicles tested using the same technical procedures. For more information contact your local Vauxhall Retailer.

**Correct at time of publication.

DIMENSIONS

Loadspace Dimensions	Hatchback	Sports Tourer
Load floor length (rear seats folded)	1575 (62.0)	1705 (67.1)
Load floor length (behind rear seats)	828 (32.5)	1065 (41.9)
Load area width	1001 (39.4)	1050 (41.3)
Load area height	841 (33.1)	822 (32.3)
Tailgate aperture width (maximum)	1015 (39.9)	1032 (40.6)
Tailgate aperture height	600 (23.6)	747 (29.4)
Luggage Capacities* litres (cu.ft.)		
Rear seat up (under luggage compartment cover)	370 (13.0)	540 (19.0)
Rear seat down (measured to roof)	1210 (42.7)	1630 (57.5)



1809 (71.2)
excluding door mirrors

2042 (80.3)
including door mirrors

1485
(58.4)

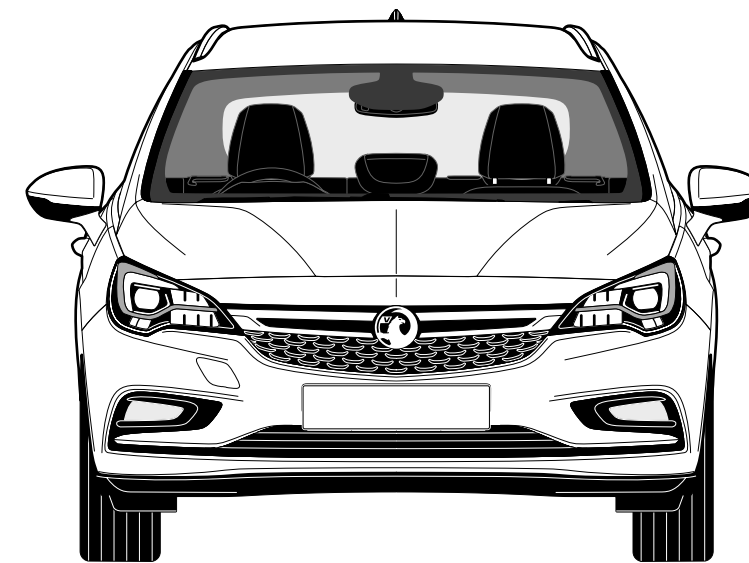

1809 (71.2)
excluding door mirrors

2042 (80.3)
including door mirrors

1510
(59.4)

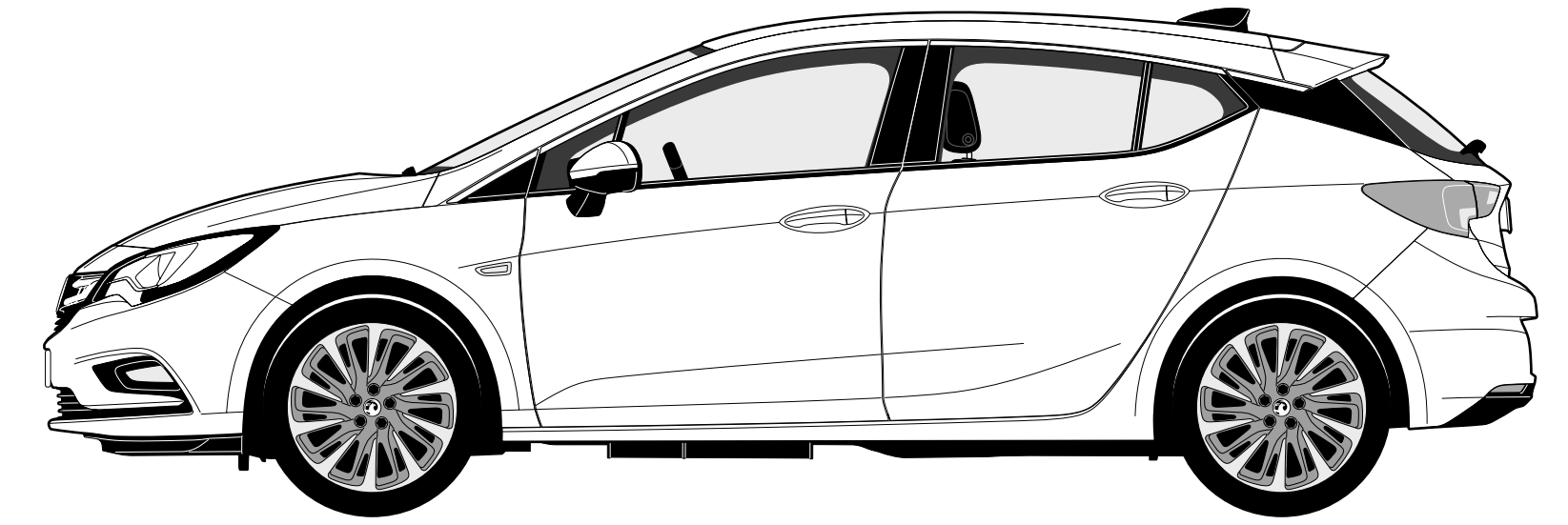

960 (37.7) 2662 (104.8) 748 (29.4)

4370 (172.0)

HATCHBACK

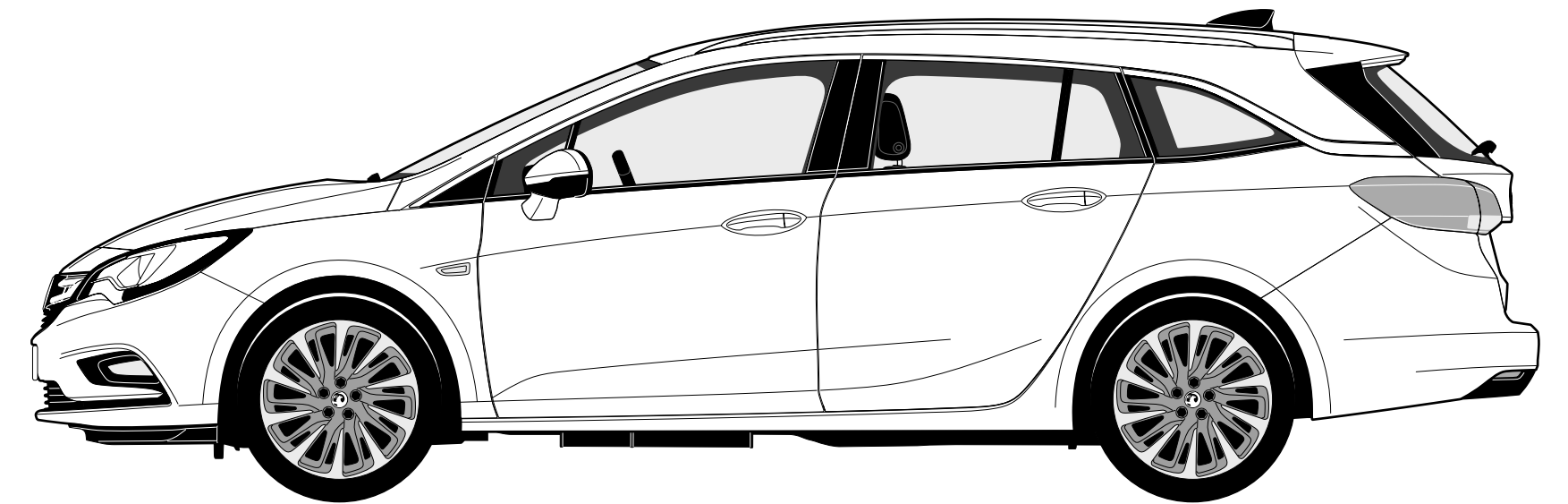

960 (37.7) 2662 (104.8) 1080 (42.5)

4702 (185.1)

SPORTS TOURER

All measurements are in mm (inches) unless stated otherwise.

*Measured using the ECIE method. When an optional spare wheel is specified loadspace capacity is reduced due to a raised luggage compartment floor.

SPECIFICATIONS

Transmission

Five-speed manual gearbox:

Standard on: 1.0i Turbo (105PS)

Six-speed manual gearbox:

Petrol engines: 1.4i Turbo (125/150PS) models

Diesel engines: 1.6CDTi (110/136PS) models

Six-speed automatic transmission with

ActiveSelect® function

A six-speed automatic transmission is optional on 1.4i Turbo (150PS) and 1.6CDTi (136PS) models.

On the road, a wide selection of shift patterns is adapted to the style and habits of the driver, anticipating when maximum acceleration or maximum efficiency is required. The electronic control will also adapt to the prevailing road conditions, reducing gear shifting when climbing or descending and using engine braking assistance during down changes.

The ActiveSelect® manual mode allows the gear lever to be used like a sequential manual gearbox – you simply push the lever forward or back to change up or down the gears. The driver also benefits from a ‘neutral’ gear disengagement at idle, which reduces vibration and contributes to improved fuel consumption.

Braking and stability

- Electronic Stability Programme (ESP)
- Cornering brake control
- Straight line stability control
- Rollover mitigation
- Drag torque control
- Hill start assist
- Anti-lock Braking System (ABS)
- Emergency brake assist
- Fading brake support
- Electronic brakeforce distribution
- Adaptive brake lights

1.0i Turbo (105PS) ecoTEC

Front ventilated discs: 276mm diameter

Rear discs: 264mm diameter

1.4i Turbo (125/150PS)

Front ventilated discs: 276mm diameter

Rear discs: 264mm diameter

1.6CDTi (110PS) ecoTEC

Front ventilated discs: 276mm diameter

Rear discs: 264mm diameter

1.6CDTi (110/136PS)

Front ventilated discs: 300mm diameter

Rear discs: 264mm diameter

Steering

- Power-assisted steering
- Turning circle (wall-to-wall): – 11.05m (36.2ft.)

Suspension

Front: Independent. Lightweight MacPherson struts with gas-pressure dampers and coil springs. Anti-roll bar.

Rear: Lightweight compound crank rear axle with one-piece, hollow cast trailing arms. Built-in anti-roll bar. Progressive-rate double conical mini-block springs and gas-pressure dampers.

Body

Aerodynamic drag co-efficient:

Hatchback – Cd 0.285

Sports Tourer – Cd 0.278

Fuel Tank Capacity

48 litres (10.5 gallons)

Weights and Towing Data kg

	Gross vehicle weight		Maximum towing weights Trailer with brakes (without brakes)	
	Hatchback	Sports Tourer	Hatchback	Sports Tourer
1.0i Turbo (105PS) Start/Stop ecoTEC	1780	1850	1220 (610)	1150 (620)
1.4i Turbo (125PS) Start/Stop	1810	1885	1450 (620)	1403 (640)
1.4i Turbo (150PS)	1820	1890	1550 (620)	1500 (640)
1.4i Turbo (150PS) Start/Stop	1810	1885	1450 (620)	1403 (640)
1.4i Turbo (150PS) Start/Stop automatic	1845	1915	1420 (620)	1420 (640)
1.6CDTi (110PS) Start/Stop ecoTEC	1850	1930	1400 (650)	1400 (670)
1.6CDTi (136PS) Start/Stop	1875	1950	1650 (650)	1500 (680)
1.6CDTi (136PS) Start/Stop automatic	1900	1975	1700 (650)	1500 (680)

Gross vehicle weight is the total permissible weight of the vehicle including passengers and their luggage. The maximum roof rack loading should not exceed 75kg on all models. The maximum towing weights are based on the ability of the car, with two occupants of 75kg each, to restart on a 12% gradient, which is approximately 1 in 8.3, at sea level. The permitted trailer load applies up to the specified incline and up to an altitude of 1000 metres above sea level. The permissible gross train weight decreases by 10% for every 1000 metres of additional altitude. Any extra weight, such as luggage or additional passengers, should be deducted from the maximum towing weight. With a trailer fully loaded, maximum noseweight should not exceed 75kg. Always fit Vauxhall towing attachments and accessories available from your Vauxhall Retailer. They are designed specifically for Vauxhall models and carry a 12-month guarantee. During trailer towing do not exceed a maximum speed of 60mph. This speed limit is also applicable in countries with higher permitted speeds for trailer-vehicle combinations. Pay attention to the local speed limits. For trailers with low driving stability and caravans the use of an oscillation damper is strongly recommended.

PETROL ENGINES

Engine	1.0i Turbo (105PS) with Start/Stop	1.4 Turbo (125PS) with Start/Stop	1.4 Turbo (150PS) with and without Start/Stop
Capacity	999cc	1399cc	1399cc
Maximum power	105PS (77kW) @ 5500rpm	125PS (92kW) @ 4000-5600rpm	150PS (110kW) @ 5000-5600rpm
Maximum torque	170Nm (125 lb.ft.) @ 1800-4250rpm	230Nm (170lb.ft.) @ 2000-3500rpm	245Nm (180lb.ft.) @ 2000-4000rpm
Configuration	3 cylinders, 4 valves per cylinder, double overhead camshafts	4 cylinders, 4 valves per cylinder, double overhead camshafts	4 cylinders, 4 valves per cylinder, double overhead camshafts
Fuel/induction system	Water-cooled turbocharger with intercooler. Variable Valve Timing (VVT). Central direct fuel injection	Water-cooled turbocharger with intercooler. Variable Valve Timing (VVT). Central direct fuel injection	Water-cooled turbocharger with intercooler. Variable Valve Timing (VVT). Central direct fuel injection
Emission compliance	Euro 6d-TEMP (6.2). Gasoline Particulate Filter	Euro 6d-TEMP (6.2). Gasoline Particulate Filter	Euro 6d-TEMP (6.2). Gasoline Particulate Filter
Service interval	20,000 miles or 1 year (whichever occurs sooner)	20,000 miles or 1 year (whichever occurs sooner)	20,000 miles or 1 year (whichever occurs sooner)

DIESEL ENGINES

Engine	1.6CDTi (110PS) Turbo diesel with Start/Stop	1.6CDTi (136PS) Turbo diesel with Start/Stop
Capacity	1598cc	1598cc
Maximum power	110PS (81kW) @ 3500rpm	136PS (100kW) @ 3500-4000rpm
Maximum torque	300Nm (221 lb.ft.) @ 1750-2000rpm	320Nm (236 lb.ft.) @ 2000-2250rpm
Configuration	4 cylinders, 4 valves per cylinder, double overhead camshafts	4 cylinders, 4 valves per cylinder, double overhead camshafts
Fuel/induction system	Turbocharger with intercooler. Common rail fuel injection	Variable geometry turbocharger with intercooler. Common rail fuel injection
Emission compliance	Euro 6d-TEMP (6.2). Diesel Particulate Filter	Euro 6d-TEMP (6.2). Diesel Particulate Filter
Service interval	20,000 miles or 1 year (whichever occurs sooner)	20,000 miles or 1 year (whichever occurs sooner)

ACCESSORIES

CHILD SEATS¹	Total (inc. VAT)
BABY-SAFE ² – 0-13kg/birth to 15 months	£141
– ISOFIX base	£244
DUO ISOFIX ² – 9-18kg/9 months to 4 years	
with top tether kit	£372
KID ² –15-36kg or 4 to 12 years	£168
INTERIOR	
PowerFlex bar	from £116
Smartphone holder ³	£51
Air freshener holder ³	£44
Air freshener refill	£13
Cupholder insert	
– Tissue	£17
– Notepad	£17
– Make-up	£17
Interior trim kit – Shaded Maori	£147
SAFETY	
Parking sensors	
– four fully flush front bumper mounted sensors	£326
– four fully flush rear bumper mounted sensors	£326
Safety Pack – first aid kit, warning triangle, hi-visibility vest, Vauxhall bag	£30
First aid kit	£15
Warning triangle	£20
Fire extinguisher – 2kg	£39
Hi-visibility vest	£9
Tyre repair kit	£156

FLEXCONNECT RANGE	Total (inc. VAT)
FlexConnect bracket	£22
FlexConnect hook	£32
FlexConnect coat hanger	£34
FlexConnect folding table	£77
FlexConnect iPad Mini cradle	£109
FlexConnect iPad (1-4) cradle	£118
FlexConnect iPad Air cradle	£117
FlexConnect Samsung Galaxy cradle	£107
PRACTICAL	
Spare bulb kit ⁴	£39
Spare bulb kit (white) ⁴	£38
Stretch tow rope – 3000kg	£36
Privacy shades	
– rear window (Hatchback)	£98
– rear side windows (Hatchback)	£86
– rear window (Sports Tourer)	£97
– rear side windows (Sports Tourer)	£109
Fog lamp wing kit	
– Carbon fibre	£106
– Brushed aluminium	£95
STYLING	
Door sill plates	£40
Illuminated door sill plates	£151
Stainless steel pedal covers	
– manual	£152
– automatic	£150

PROTECTION	Total (inc. VAT)
Rubber floor mats – set of four	£60
Velour floor mats – set of four	£64
Economy floor mats – set of four	£30
Cargo liner ⁵	from £95
Cargo net – horizontal	£22
Cargo net – sidewall	£18
Cargo net – vertical (Sports Tourer)	£80
Tyre valve covers with Vauxhall logo (set of 4)	£24
Load compartment storage tray – hatchback only ⁶	£79
Mudflaps	
– front	£50
– rear ⁷ (Hatchback)	£52
– rear (Sports Tourer)	£58
Dog guard (Sports Tourer)	£204
Door mirror caps	
– Black	£95
– White	£132
Bumper load protection foil	£61
ALLOY WHEELS (set of four with centre caps)⁸	
17-inch 10 V-spoke	£1,032
18-inch 10 double-spoke	£1,618

TRANSPORT SYSTEMS	Total (inc. VAT)
Roof base carrier	from £217
Roof carriers (requires base carrier)	
Bike roof carrier – Thule Freeride 532	£78
Surf board roof carrier – Thule 833	£82
Kayak roof carrier – Thule 837	£172
Ski roof carrier – up to 4 pairs (400mm wide) – Thule 7324	£161
Ski roof carrier – up to 6 pairs (600mm wide) – Thule 7326	£190
Hard shell roof boxes (requires base carrier)	
Thule Ocean 80 (320 litre/1330 x 860 x 370mm)	£154
Thule Ocean 200 (450 litre/1750 x 820 x 450mm)	£323
Thule Motion 800 (460 litre/2050 x 840 x 450mm)	from £463
Thule Touring 200 (400 litre/1750 x 820 x 450mm)	£338
Thule Touring 700 (430 litre/2320 x 700 x 420mm)	£384
Tow bar carrier system	
Fixed tow bar ⁹	£544
Detachable tow bar	from £715

Please note: Prices shown are fully fitted and painted, where applicable and include VAT. Please check with your local Vauxhall Retailer for details. It is advisable to ensure your insurance policy is adequate to cover additional fitted accessories. Prices correct at time of publication.

¹Restrictions apply to the use of child seats, please consult your Vauxhall Retailer or request a copy of the Child seats brochure. ²Without transponder. ³Only for use with PowerFlex Bar. ⁴Excludes xenon headlight bulb for models with Adaptive Forward Lighting (AFL). ⁵On Hatchback – for vehicles with spare wheel. For vehicles without spare wheel, load compartment storage tray required to use cargo liner. ⁶For vehicles without spare wheel. ⁷Not available with certain exterior styling products. ⁸Different tyres and locking wheel bolts/nuts may be required at extra cost. Price excludes new tyres and locking wheel bolts/nuts, includes static wheel balancing. ⁹Available with 13-pin electrics. Sports Tourer only. Please consult your Vauxhall Retailers for details.

COMPANY CAR DRIVER AND FLEET INFORMATION

Design and Tech Line High Spec Low P11D

Specifically developed for businesses and company car drivers alike, our Design and Tech Line Nav models are seriously fit for Fleet.

Design models all feature very low P11D values, generous standard specification, including Sat Nav on Design Nav models, and a choice of high tech ecoTEC engines for great fuel economy and low emissions.

For even more standard specification, step up to our Tech Line Nav range. Again you are guaranteed low P11D values, plus great standard kit including Sat Nav, Bluetooth®, USB connection, aux-in socket and digital radio.

With Design and Tech Line Nav you can take for granted low Whole Life Costs and low company car driver taxation.

Company Car Driver Free 3 Day Test Drive

Our free* 3 Day Test Drive programme is open to all Company Car Drivers which allows you to choose any model in the current Vauxhall line-up (exclusions apply). With full insurance cover provided, it gives you a meaningful length of time to make an informed decision about your next company car.

Search Vauxhall 3DTD to book your FREE* test drive or click the link the below:

[Vauxhall 3 Day Test Drive](#)

*The free 3 Day Test Drive programme is open to Company Car Drivers and Fleet Decision Makers. Available for UK Mainland only. Terms and conditions apply. Full terms and conditions can be found at vauxhallfleet.co.uk/testdrive/index/terms.

Benefit in kind company car taxation†

The car benefit charge will be the car's list price (including VAT, options and accessories fitted, delivery to Retailer and number plates, but excluding Vehicle Excise Duty and new vehicle first registration fee) multiplied by the percentage charge for the CO₂ emissions band in which the car falls (see table opposite). Multiply this figure by your personal income tax rate (20%^{††} for Basic Rate, 40%^{††} for Higher Rate) to calculate your annual benefit in kind tax liability.

Example:

Astra Tech Line Nav 1.6CDTi (110PS) Start/Stop ecoTEC 5-door hatchback (CO₂ emissions 107g/km)	
On-the-road RRP	£21,075.00
Deduct: Vehicle Excise Duty	(£170.00)
New vehicle first registration fee	(£55.00)
Effective list price	£20,850.00
Add: Optional two-coat metallic paint	£575.00
List price for tax purposes (P11D value)	£21,425.00
Car benefit charge 2019–20 tax year (29%)	£6,213.00
Benefit in kind tax liability (2019–20 tax year)	
Basic Rate (20%) tax payer	£1,242.60
Higher Rate (40%) tax payer	£2,485.20

†Please note this Price Guide provides taxation information as a guide only. Vauxhall does not provide taxation guidance. Drivers should always take professional advice on their own tax position.

††Excludes residents of Scotland.

BIK FOR SCOTTISH RESIDENTS

Effective 6 April 2018 the Scottish Government have introduced their own BIK taxation structure. This only applies to Company Car Drivers that are Scottish taxpayers. HMRC will determine whether or not an individual is a Scottish taxpayer based on where their main place of residence is.

The BIK rates for Scotland are:

- Over £12,500–£14,549 Starter Rate 19%
- Over £14,549–£24,994 Basic Rate 20%
- Over £24,994–£43,430 Intermediate Rate 21%
- Over £43,430–£150,000 Higher Rate 41%
- Above £150,000 Top Rate 46%

Benefit in kind company car taxation table

CO ₂ emissions in grams per kilometre	Percentage of cars price to be taxed	
	Non-Diesel [#] 2019-20 tax year	Diesel ^{##} 2019-20 tax year
Up to 50	16	20
51-75	19	23
76-94	22	26
95-99	23	27
100-104	24	28
105-109	25	29
110-114	26	30
115-119	27	31
120-124	28	32
125-129	29	33
130-134	30	34
135-139	31	35
140-144	32	36
145-149	33	37
150-154	34	37
155-159	35	37
160-164	36	37
165-169	37	37
170-174	37	37
175-179	37	37
180 and above	37	37

[#]Also applies to diesel vehicles that meet the Real Driving Emissions Step 2 (RDE2). ^{##}Applies to vehicles that do not meet the Real Driving Emissions Step 2 (RDE2).

To calculate your own personal liability, search: **Vauxhall BiK**, or click the link below: [Vauxhall BiK Tool](#)

Fleet Toolbox

Discover the facts in our online Toolbox for both Company Car Drivers and Fleet Decision Makers. The Fleet Toolbox has a host of useful calculators, comparators, interactive listings and information.

Search Vauxhall Fleet Tools or click the link below: [Vauxhall Fleet Tool Box](#)

Contact Vauxhall Fleet

Please contact one of our dedicated sales teams who will be happy to help with your particular enquiry.

Company Car Drivers

Call: 0345 111 2020

Email: company-car@vauxhallinfo.co.uk

Telephone lines are open

– Monday to Friday 8:00am–9:00pm

– Saturday and Sunday 9:00am–6:00pm

Fleet Decision Makers

Depending on the size of your fleet of vehicles, we have a dedicated team to handle your enquiries. The lines are open Monday to Friday excluding Bank Holidays.

1-24 vehicles

Call: 0845 076 2254 (8:30am–5:00pm)

25+ vehicles

Call: 0330 587 8222 (8:30am–5:00pm)

Email: vauxhallfleet@vauxhall.co.uk

Special Vehicles (Police, Fire and Ambulance)

Call: 01582 409999 (8:30am–5:00pm)

Email: vauxhallspecialvehicles@vauxhall.co.uk

For more information visit www.vauxhall.co.uk/fleet

FURTHER INFORMATION

On-the-road prices

To eliminate uncertainty about hidden costs when buying a new car, Vauxhall publishes on-the-road recommended retail prices (RRP) and these are shown in the pricing tables within this price guide. These prices include VAT, number plates and delivery to Retailer of £700.00 (including £116.67 VAT), 12 months' Government Vehicle Excise Duty (see opposite for details) and the DVLA new vehicle first registration fee of £55.00.*

Please note: The on-the-road recommended retail price (RRP) does not include fuel supplied by the Retailer, motor insurance or any other goods or services supplied by agreement between the Retailer and the customer.

Price protection

Order a new Vauxhall for build in the current model year (as confirmed by your Retailer) for delivery no more than three months in advance and the price you are quoted is the price you pay. This is irrespective of any subsequent price rises between placing your order and delivery of your new car, but you must take delivery as soon as the car is available. Vauxhall Motors Limited is not liable for price adjustments caused by Government changes in the rate of VAT (currently 20%), Vehicle Excise Duty, DVLA new vehicle first registration fee or by any other applicable legislation or regulations.

Vauxhall Finance Leasing

Vauxhall Finance Leasing is a trading style of Vauxhall Finance plc. Working with the Vauxhall Retailer network we provide competitive car and van leasing solutions for business users and private individuals. We combine the support of a national contract with the convenience of a local contact.

For further information, please contact your local Vauxhall Retailer or visit www.vauxhall.co.uk/leasing

In the event of an accident

Vauxhall Accident Management helps keep you mobile following an accident. Benefits include vehicle recovery, Vauxhall-approved repairs and contacting your insurer. For more details, visit www.vauxhall.co.uk/AccidentManagement

Vehicle Excise Duty

The amount of Vehicle Excise Duty (road fund licence) payable on new cars varies depending on the level of carbon dioxide (CO₂) emissions produced by the vehicle. CO₂ emissions are measured in grams per kilometre (g/km) travelled and divided into 13 charging bands shown in the table opposite.

A 'first year rate' of Vehicle Excise Duty is payable on all new cars and in subsequent years the amount payable reverts to the 'standard rate'. From 1 April 2017 the breakpoints for each of these bands have been revised. Also, for vehicles with a list price over £40,000, including factory-fitted options, an additional £320 is payable for the first five years of standard rate payments.

Vehicle Excise Duty*

Band	CO ₂ emissions in grams per kilometre	First year rate		Standard rate
		Petrol [#]	Diesel [†]	
A	0	£0	£0	£0
B	1-50	£10	£25	£145
C	51-75	£25	£110	£145
D	76-90	£110	£130	£145
E	91-100	£130	£150	£145
F	101-110	£150	£170	£145
G	111-130	£170	£210	£145
H	131-150	£210	£530	£145
I	151-170	£530	£855	£145
J	171-190	£855	£1,280	£145
K	191-225	£1,280	£1,815	£145
L	226-255	£1,815	£2,135	£145
M	over 255	£2,135	£2,135	£145

*Correct at time of issue.

[#]Also applies to diesel vehicles that meet the Real Driving Emissions Step 2 (RDE2).

[†]Applies to vehicles that do not meet the Real Driving Emissions Step 2 (RDE2).

FURTHER INFORMATION

Customer Care Commitment

For added peace of mind, Vauxhall has an innovative Customer Care Commitment that offers the following:

- Three-year vehicle warranty consisting of a one-year/unlimited mileage manufacturer's warranty and a second and third year manufacturer's warranty with a 60,000 miles limitation
- Vauxhall Assistance for 12 months from first registration
- Six years' body panel anti-perforation warranty

Please note: Warranty is only available on vehicles sourced from Vauxhall Motors Limited. Terms and conditions apply – please see your Vauxhall Retailer for details.

Vauxhall Assistance

Vauxhall Assistance is provided automatically with every new Vauxhall for 12 months from first registration and covers everything from accident assistance, roadside recovery and 'at home' service to flat tyres. With Vauxhall Assistance help is literally just a free* phone call away, 24 hours a day, 365 days a year!

Protecting the environment

Vauxhall's commitment to the environment is demonstrated by our products' many environmental awards. For even more information on Vauxhall's efforts to achieve an environmentally sustainable future, and how to dispose of your end-of-life vehicle, see www.vauxhall.co.uk/recycling

Vauxhall Service Plan

- Fixed monthly payments for the plan duration
- Easy to budget and interest-free
- Genuine parts fitted by Vauxhall-trained technicians

Plus on Gold plans:

- Valet and courtesy car
- Vauxhall Roadside Assistance
- Engine flush and fuel treatments
- Litre of oil for top ups between services

Full details can be obtained from your local participating Vauxhall Retailer.

Vauxhall Insurance with added reassurance

Comprehensive cover – Summary of benefits**

- Competitive premiums
- Repairs by a Vauxhall-trained technician
- Genuine Vauxhall parts, guaranteed for three years when we repair your car within our Approved Repairer Network
- Free courtesy car as standard when using an Approved Repairer†
- 24 hour claims helpline
- Personal Accident benefit
- Cover for audio equipment
- Windscreen cover

Call for a quote on **0844 463 2670**††

For more product information

For further information on the Vauxhall range or location of your nearest Vauxhall Retailer please call **0345 600 1500**. Alternatively, details can be found on our website at www.vauxhall.co.uk

*Mobile phone users will be charged at their standard tariff.

**The benefits listed above are for comprehensive cover only. For details of Third Party, Fire and Theft cover, please call our sales team.

†Should your car need repairing following an accident we provide a courtesy car (subject to availability) for the duration of the repair. Only genuine Vauxhall parts are used. Terms and conditions apply.

††Calls may be recorded. Vauxhall Insurance is underwritten by Ageas Insurance Limited.

Take the next step:



Join us online:

Discover the full Vauxhall range at [vauxhall.co.uk](https://www.vauxhall.co.uk) >

Privacy Policy: For full details please visit [vauxhall.co.uk/privacy](https://www.vauxhall.co.uk/privacy)

The invoice price, including delivery to Retailer, factory-fitted options, accessories fitted by the Retailer and number plates, is subject to VAT. Some feature descriptions in this guide may refer to, and some illustrations may show, optional equipment not included in the standard delivery. The information contained in this guide was accurate at the time of publication. We reserve the right to make changes in design and equipment. Please note that Vauxhall Retailers are not the agents of Vauxhall Motors Limited and are not authorised to bind Vauxhall Motors Limited by any specific or implied undertaking or representation. It is advisable to ensure that your motor insurance policy provides adequate cover for additional fitted options and accessories. The colours in this guide are only approximate actual colours. Illustrated optional equipment is available at extra charge. Availability, technical features and equipment provided on our vehicles can vary by model. For precise information on the equipment provided on our vehicles, please contact your local Vauxhall Retailer.

INSIGNIA

Price and Specification Guide | 1 April 2019 | Model Year 2019.5



VAUXHALL
British Brand since 1903

CONTENTS

To find the information you want use the links below to navigate around the guide:

[RANGE HIGHLIGHTS >](#)

Explore the Insignia range and find your perfect model.

[MODELS >](#)

Find all the information you need about your chosen model.

[PRICES >](#)

Find on-the-road recommended retail prices.

[FEATURES/OPTIONS >](#)

Tailor your chosen model to suit your needs with everything from satellite navigation to parking sensors.

[EXTERIOR COLOURS >](#)

Add some sparkle to your car with a metallic paint.

[WHEELS AND TYRES >](#)

Why not upgrade to a set of distinctive alloy wheels to give your car more presence.

[PERFORMANCE, FUEL ECONOMY AND EMISSIONS >](#)

Know how many miles you will get around town, the CO₂ figures and the 0-60 time.

[DIMENSIONS >](#)

Ensure your car will fit in the garage and know how much luggage you can take for a long weekend away.

[SPECIFICATIONS >](#)

Towing weights, engine details and other useful details you may need to know.

[ACCESSORIES >](#)

Add some practical touches to your car with our range of quality accessories.

[COMPANY CAR INFORMATION >](#)

Benefit in Kind company car tax, 3 day test drives and P11D.

[FURTHER INFORMATION >](#)

Price protection, vehicle excise duty, our range of additional products and much more.

INSIGNIA RANGE HIGHLIGHTS



DESIGN OTR from £19,945

Standard features include:

Infotainment:

- Multimedia audio system
 - 7-inch colour touchscreen
 - Bluetooth®/Apple CarPlay™/Android Auto™
- Seven speakers (five front, two rear)

Interior convenience/styling:

- Air conditioning
- Leather-covered steering wheel
- Steering wheel audio/phone/cruise controls
- Steering column adjustable for reach/rake

Exterior convenience/styling:

- 17-inch bi-colour structure wheels (1.6 diesel ecoTEC models)
- 17-inch five twin-spoke alloy wheels (excluding 1.6 diesel ecoTEC models)
- Automatic lighting control
- Electrically operated front/rear windows
- Electrically adjustable/heated door mirrors

Safety/security:

- Electronic Stability Programme (ESP)
- Anti-lock Braking System (ABS)
- Driving Assistance Pack One
- Six airbags
- Keyless start
- Security alarm system (Thatcham approved, T1)

DESIGN NAV OTR from £20,745

Design Nav models additional feature:

- Multimedia Navi system
 - Fully integrated sat nav system
 - 7-inch colour touchscreen



SRi OTR from £22,715

Features over Design:

Interior convenience/styling:

- AGR active front seats
- Sports pedals
- Dual-zone electronic climate control
- Illuminated vanity mirrors
- Storage pockets on front seat backs
- Ambient LED lighting in front doors
- Twin rear USB sockets
- Auto-dimming rear-view mirror

Exterior convenience/styling:

- 17-inch five twin-spoke alloy wheels
- Front fog lights
- Rear spoiler (Grand Sport models)
- Rain-sensitive windscreen wipers
- Silver-effect roof rails (Sports Tourer models)
- Front and rear parking sensors

SRi NAV OTR from £23,505

SRi Nav models additionally feature:

- Multimedia Navi system
 - Fully integrated sat nav system
 - 7-inch colour touchscreen



SRi VX-LINE NAV OTR from £24,725

Features over SRi:

Infotainment:

- Multimedia Navi system
 - Fully integrated sat nav system
 - 7-inch colour touchscreen

Interior convenience/styling:

- Heated, flat-bottom, leather-covered VX-Line steering wheel
- Dark fabric headlining

Exterior convenience/styling:

- 17-inch five twin-spoke alloy wheels (1.6 diesel manual models)
- 18-inch five-spoke alloy wheels (excluding 1.6 diesel manual and 1.6 (200PS) Turbo models)
- 20-inch five twin-spoke alloy wheels (1.6 (200PS) Turbo models)
- VX-Line Styling Pack
 - Sports-style front and rear bumpers
 - Side sills
 - Dual visible exhaust tailpipes (restrictions apply, see Exterior Styling for details)

INSIGNIA RANGE HIGHLIGHTS



TECH LINE NAV OTR from £23,305

Features over Design:

Infotainment:

- Multimedia Navi system
 - Fully integrated sat nav system
 - 7-inch colour touchscreen

Interior convenience/styling:

- Dual-zone electronic climate control
- AGR active drivers seat
- Twin rear USB sockets
- Auto-dimming rear-view mirror
- Driver's seat tilt and lumbar adjustment
- Front passenger's seat height adjustment

Exterior convenience/styling:

- 17-inch five twin-spoke alloy wheels
- Rain-sensitive windscreen wipers
- Front and rear parking sensors
- Silver-effect roof rails (Sports Tourer models)



ELITE NAV OTR from £26,535

Features over Tech Line Nav:

Infotainment:

- Multimedia Navi Pro system
 - Fully integrated European sat nav system
 - 8-inch colour touchscreen
- Bose® premium sound system (2.0 (210PS) BiTurbo D 4X4 models)

Interior convenience/styling:

- AGR active front seats
- Leather seat facings
- Heated front seats
- 8-inch colour information display

Exterior convenience/styling:

- 17-inch five twin-spoke alloy wheels (1.6 diesel manual models)
- 18-inch bi-colour alloy wheels (excluding 1.6 diesel manual, 1.6 (200PS) Turbo and 2.0 (210PS) BiTurbo D 4X4 models)
- 20-inch five twin-spoke alloy wheels (1.6 (200PS) Turbo and (210PS) BiTurbo D 4X4 models)
- IntelliLux LED® matrix headlights
- Front fog lights
- Dark-tinted rear windows
- Torque vectoring system (4X4 models)



GSi NAV OTR from £38,260

Features over Tech Line Nav:

Infotainment:

- Multimedia Navi Pro system
 - Fully integrated European sat nav system
 - 8-inch colour touchscreen
- Bose® premium sound system

Interior convenience/styling:

- Perforated leather seat facings
- Ergonomic AGR active front seats
- Heated front and outer rear seats
- Heated, flat-bottom, leather-covered steering wheel
- Head-up display
- 8-inch colour information display
- Dark fabric headlining
- Sports pedals
- FlexOrganiser® Pack (Sports Tourer models)

Exterior convenience/styling:

- 20-inch five twin-spoke alloy wheels
- GSi front and rear bumpers
- GSi side sills
- GSi rear spoiler (Grand Sport models)
- Visible exhaust tailpipes
- IntelliLux LED® matrix headlights
- FlexRide with Competition mode
- Sports chassis
- Dark-tinted rear windows
- Torque vectoring system



COUNTRY TOURER OTR from £27,165

Standard features include:

Infotainment:

- Multimedia Navi system
 - Fully integrated sat nav system
 - 7-inch colour touchscreen
 - Bluetooth®/Apple CarPlay™/Android Auto™
- Seven speakers (five front, two rear)
- Bose® premium sound system (2.0 (210PS) BiTurbo D 4X4 models)

Interior convenience/styling:

- Dual-zone electronic climate control
- Leather-covered steering wheel
- Steering wheel audio/phone/cruise controls
- Steering column adjustable for reach/rake

Exterior convenience/styling:

- 18-inch bi-colour five twin-spoke alloy wheels
- Anthracite wheel arch and side sill extensions
- Front and rear bumpers incorporating silver-effect skid plates
- Silver-effect roof rails
- Front and rear parking sensors
- FlexRide
- Automatic lighting control
- Electrically operated front/rear windows
- Electrically adjustable/heated door mirrors

Safety/security:

- Electronic Stability Programme (ESP)
- Anti-lock Braking System (ABS)
- Driving Assistance Pack One
- Six airbags
- Keyless start
- Security alarm system (Thatcham approved, T1)

DESIGN



DESIGN ON-THE-ROAD PRICES

	Grand Sport		Sports Tourer		Insurance
	OTR RRP	CO ₂ (g/km)	OTR RRP	CO ₂ (g/km)	Group
Petrol					
1.5 (140PS) Turbo	£19,945	129	£21,505	131	14E
1.5 (165PS) Turbo	£20,245	129	£21,805	131	16E
1.5 (165PS) Turbo auto	£21,885	138	£23,405	144	16E
Diesel					
1.6 (110PS) Turbo D ecoTEC	£20,345	116	£21,845	121	13E
1.6 (136PS) Turbo D	£20,845	121	£22,345	125	15E
1.6 (136PS) Turbo D auto	£22,765	137	£24,265	139	15E
2.0 (170PS) Turbo D	-	-	£23,465	145	20E
2.0 (170PS) Turbo D auto	-	-	£25,065	148	20E

DESIGN NAV ON-THE-ROAD PRICES

	Grand Sport		Sports Tourer		Insurance
	OTR RRP	CO ₂ (g/km)	OTR RRP	CO ₂ (g/km)	Group
Petrol					
1.5 (140PS) Turbo	£20,745	129	£22,305	131	14E
1.5 (165PS) Turbo	£21,045	129	£22,605	131	16E
1.5 (165PS) Turbo auto	£22,685	138	£24,205	144	16E
Diesel					
1.6 (110PS) Turbo D ecoTEC	£21,145	116	£22,645	121	13E
1.6 (136PS) Turbo D	£21,645	121	£23,145	125	16E
1.6 (136PS) Turbo D auto	£23,565	137	£25,065	139	16E
2.0 (170PS) Turbo D	-	-	£24,265	145	20E
2.0 (170PS) Turbo D auto	-	-	£25,865	148	20E

Please note: On-the-road recommended retail prices (RRP) include VAT at 20%, number plates and delivery to Retailer of £700.00 (inc. £116.67 VAT), 12 months' Vehicle Excise Duty and new vehicle first registration fee of £55.00. Excludes fuel and insurance.

FEATURES

Infotainment:

- Multimedia audio system
 - 7-inch colour touchscreen
 - AM/FM/DAB digital radio
 - Bluetooth® audio streaming
 - Bluetooth® mobile phone portal
 - Apple CarPlay™/Android Auto™
 - USB audio connection
- Seven speakers (five front, two rear)

Interior convenience/styling:

- Air conditioning
- Multi-function trip computer
- Cruise control with speed limiter
- Leather-covered steering wheel
- Front centre armrest
- Steering wheel audio/phone/cruise controls
- Steering column adjustable for reach/rake

Exterior convenience/styling:

- 17-inch bi-colour structure wheels (1.6 diesel ecoTEC models)
- 17-inch five twin-spoke alloy wheels (excluding 1.6 diesel ecoTEC models)
- Automatic lighting control
- Electrically operated front/rear windows
- Electrically adjustable/heated door mirrors
- Black roof rails (Sports Tourer models)

Safety/security:

- Driving Assistance Pack One
 - Front camera system
 - Forward collision alert with automatic city emergency braking
 - Following distance indicator
 - Lane departure warning with lane assist
- Electronic Stability Programme (ESP)
- Anti-lock Braking System (ABS)
- Six airbags
- Hill start assist
- ISOFIX child seat mounting points, outer rear seats
- Tyre pressure monitoring system
- LED daytime running lights
- Keyless start
- Remote control central locking
- Security alarm system (Thatcham approved, T1)

DESIGN NAV MODELS ADDITIONALLY FEATURE

- Multimedia Navi system
 - Fully integrated sat nav system
 - 7-inch colour touchscreen
- Traffic sign recognition

SRI



SRI ON-THE-ROAD PRICES

	Grand Sport		Sports Tourer		Insurance Group
	OTR RRP	CO ₂ (g/km)	OTR RRP	CO ₂ (g/km)	
Petrol					
1.5 (165PS) Turbo	£22,715	129	£24,275	131	17E
1.5 (165PS) Turbo auto	£24,355	138	£25,875	144	17E
Diesel					
1.6 (110PS) Turbo D ecoTEC	£22,815	116	£24,315	121	14E
1.6 (136PS) Turbo D	£23,315	121	£24,815	125	16E
1.6 (136PS) Turbo D auto	£25,235	137	£26,735	139	16E
2.0 (170PS) Turbo D	£24,435	141	£25,935	145	20E
2.0 (170PS) Turbo D auto	£26,035	146	£27,535	148	20E

SRI NAV ON-THE-ROAD PRICES

	Grand Sport		Sports Tourer		Insurance Group
	OTR RRP	CO ₂ (g/km)	OTR RRP	CO ₂ (g/km)	
Petrol					
1.5 (165PS) Turbo	£23,505	129	£25,065	131	17E
1.5 (165PS) Turbo auto	£25,145	138	£26,665	144	17E
Diesel					
1.6 (110PS) Turbo D ecoTEC	£23,605	116	£25,105	121	14E
1.6 (136PS) Turbo D	£24,105	121	£25,605	125	16E
1.6 (136PS) Turbo D auto	£26,025	137	£27,525	139	16E
2.0 (170PS) Turbo D	£25,225	141	£26,725	145	20E
2.0 (170PS) Turbo D auto	£26,825	146	£28,325	148	20E

Please note: On-the-road recommended retail prices (RRP) include VAT at 20%, number plates and delivery to Retailer of £700.00 (inc. £116.67 VAT), 12 months' Vehicle Excise Duty and new vehicle first registration fee of £55.00. Excludes fuel and insurance.

FEATURES

Infotainment:

- Multimedia audio system
 - 7-inch colour touchscreen
 - AM/FM/DAB digital radio
 - Bluetooth® audio streaming
 - Bluetooth® mobile phone portal
 - Apple CarPlay™/Android Auto™
 - USB audio connection
- Seven speakers (five front, two rear)

Interior convenience/styling:

- AGR active front seats
- Dual-zone electronic climate control
- Multi-function trip computer
- Cruise control with speed limiter
- Leather-covered steering wheel
- Front centre armrest
- Steering wheel audio/phone/cruise controls
- Steering column adjustable for reach/rake
- Sports pedals
- Twin rear USB sockets
- Auto-dimming rear-view mirror
- Illuminated vanity mirrors
- Storage pockets on front seat backs
- Ambient LED lighting in front doors

Exterior convenience/styling:

- 17-inch five twin-spoke alloy wheels
- Front fog lights

- Automatic lighting control with tunnel detection
- Rain-sensitive windscreen wipers
- Electrically adjustable/heated door mirrors
- Rear spoiler (Grand Sport models)
- Front and rear parking sensors
- Silver-effect roof rails (Sports Tourer models)

Safety/security:

- Driving Assistance Pack One
 - Front camera system
 - Forward collision alert with automatic city emergency braking
 - Following distance indicator
 - Lane departure warning with lane assist
- Electronic Stability Programme (ESP)
- Anti-lock Braking System (ABS)
- Six airbags
- ISOFIX child seat mounting points, outer rear seats
- Tyre pressure monitoring system
- LED daytime running lights
- Security alarm system (Thatcham approved, T1)

SRI NAV MODELS ADDITIONALLY FEATURE

- Multimedia Navi system
 - Fully integrated sat nav system
 - 7-inch colour touchscreen
- Traffic sign recognition

SRI VX-LINE NAV



SRI VX-LINE NAV ON-THE-ROAD PRICES

	Grand Sport		Sports Tourer		Insurance Group
	OTR RRP	CO ₂ (g/km)	OTR RRP	CO ₂ (g/km)	
Petrol					
1.5 (165PS) Turbo	£24,725	126	£26,285	128	17E
1.5 (165PS) Turbo auto	£26,365	135	£27,885	140	17E
1.6 (200PS) Turbo	£26,265	145	£28,105	151	25E
1.6 (200PS) Turbo auto	£29,635	153	£31,155	154	25E
Diesel					
1.6 (136PS) Turbo D	£25,325	121	£26,825	125	16E
1.6 (136PS) Turbo D auto	£27,245	137	£28,745	139	16E
2.0 (170PS) Turbo D	£26,445	138	£27,945	142	21E
2.0 (170PS) Turbo D auto	£28,045	144	£29,545	147	21E

Please note: On-the-road recommended retail prices (RRP) include VAT at 20%, number plates and delivery to Retailer of £700.00 (inc. £116.67 VAT), 12 months' Vehicle Excise Duty and new vehicle first registration fee of £55.00. Excludes fuel and insurance.

FEATURES

Infotainment:

- Multimedia Navi system
 - Fully integrated sat nav system
 - 7-inch colour touchscreen
 - AM/FM/DAB digital radio
 - Bluetooth® audio streaming
 - Bluetooth® mobile phone portal
 - Apple CarPlay™/Android Auto™
 - USB audio connection
- Seven speakers (five front, two rear)

Interior convenience/styling:

- AGR active front seats
- Dual-zone electronic climate control
- Multi-function trip computer
- Cruise control with speed limiter
- Steering wheel audio/phone/cruise controls
- Heated, flat bottom, leather-covered VX-Line steering wheel
- Steering column adjustable for reach/rake
- Sports pedals • Dark fabric headlining
- Twin rear USB sockets
- Auto-dimming rear-view mirror

Exterior convenience/styling:

- 17-inch alloy wheels (1.6 diesel manual models)
- 18-inch alloy wheels (excluding 1.6 diesel manual and 1.6 (200PS) Turbo models)
- 20-inch five twin-spoke alloy wheels (1.6 (200PS) Turbo models)

- VX-Line Styling Pack
 - Sports-style front and rear bumpers
 - Side sills
 - Rear spoiler (Grand Sport models)
 - Dual visible exhaust tailpipes (restrictions apply, see Exterior Styling for details)
- Chrome-effect upper window trim
- Automatic lighting control with tunnel detection
- Electrically operated front/rear windows
- Electrically adjustable/heated door mirrors
- Front and rear parking sensors
- Silver-effect roof rails (Sports Tourer models)

Safety/security:

- Driving Assistance Pack One
 - Front camera system
 - Forward collision alert with automatic city emergency braking
 - Following distance indicator
 - Lane departure warning with lane assist
 - Traffic sign recognition
- Electronic Stability Programme (ESP)
- Anti-lock Braking System (ABS) • Six airbags
- ISOFIX child seat mounting points, outer rear seats
- Tyre pressure monitoring system
- LED daytime running lights
- Remote control central locking
- Security alarm system (Thatcham approved, T1)

TECH LINE NAV



TECH LINE NAV ON-THE-ROAD PRICES

	Grand Sport		Sports Tourer		Insurance Group
	OTR RRP	CO ₂ (g/km)	OTR RRP	CO ₂ (g/km)	
Petrol					
1.5 (165PS) Turbo	£23,305	129	£24,865	131	17E
1.5 (165PS) Turbo auto	£24,945	138	£26,465	144	17E
Diesel					
1.6 (110PS) Turbo D ecoTEC	£23,405	116	£24,905	121	14E
1.6 (136PS) Turbo D	£23,905	121	£25,405	125	16E
1.6 (136PS) Turbo D auto	£25,825	137	£27,325	139	16E
2.0 (170PS) Turbo D	£25,025	141	£26,525	145	21E
2.0 (170PS) Turbo D auto	£26,625	146	£28,125	148	21E

Please note: On-the-road recommended retail prices (RRP) include VAT at 20%, number plates and delivery to Retailer of £700.00 (inc. £116.67 VAT), 12 months' Vehicle Excise Duty and new vehicle first registration fee of £55.00. Excludes fuel and insurance.

FEATURES

Infotainment:

- Multimedia Navi system
 - Fully integrated sat nav system
 - 7-inch colour touchscreen
 - AM/FM/DAB digital radio
 - Bluetooth® audio streaming
 - Bluetooth® mobile phone portal
 - Apple CarPlay™/Android Auto™
 - USB audio connection
- Seven speakers (five front, two rear)

Interior convenience/styling:

- Dual-zone electronic climate control
- Multi-function trip computer
- 16-way adjustable driver's seat
- Front centre armrest
- Storage pockets on front seat backs
- Cruise control with speed limiter
- Leather-covered steering wheel
- Steering wheel audio/phone/cruise controls
- Steering column adjustable for reach/rake
- Twin rear USB sockets
- Auto-dimming rear-view mirror

Exterior convenience/styling:

- 17-inch five twin-spoke alloy wheels
- Chrome-effect upper window trim
- Rain-sensitive windscreen wipers
- Automatic lighting control with tunnel detection
- Electrically adjustable/heated door mirrors
- Front and rear parking sensors
- Silver-effect roof rails (Sports Tourer models)

Safety/security:

- Driving Assistance Pack One
 - Front camera system
 - Forward collision alert with automatic city emergency braking
 - Following distance indicator
 - Lane departure warning with lane assist
 - Traffic sign recognition
- Electronic Stability Programme (ESP)
- Anti-lock Braking System (ABS)
- Six airbags
- Hill start assist
- ISOFIX child seat mounting points, outer rear seats
- Tyre pressure monitoring system
- LED daytime running lights
- Security alarm system (Thatcham approved, T1)
- Electronic engine deadlock immobiliser

ELITE NAV



ELITE NAV ON-THE-ROAD PRICES

	Grand Sport		Sports Tourer		Insurance
	OTR RRP	CO ₂ (g/km)	OTR RRP	CO ₂ (g/km)	Group
Petrol					
1.5 (165PS) Turbo	£26,535	126	£28,095	128	17E
1.5 (165PS) Turbo auto	£28,175	135	£29,695	140	17E
1.6 (200PS) Turbo	£28,075	145	£29,915	151	25E
1.6 (200PS) Turbo auto	£30,845	153	£32,365	154	25E
Diesel					
1.6 (110PS) Turbo D ecoTEC	£26,635	116	£28,135	121	16E
1.6 (136PS) Turbo D	£27,135	121	£28,635	125	18E
1.6 (136PS) Turbo D auto	£29,055	137	£30,555	139	18E
2.0 (170PS) Turbo D	£28,255	138	£29,755	142	23E
2.0 (170PS) Turbo D auto	£29,855	144	£31,355	147	23E
2.0 (210PS) BiTurbo D 4X4 auto	£31,200	184	£32,700	187	27E

Please note: On-the-road recommended retail prices (RRP) include VAT at 20%, number plates and delivery to Retailer of £700.00 (inc. £116.67 VAT), 12 months' Vehicle Excise Duty and new vehicle first registration fee of £55.00. Excludes fuel and insurance.

FEATURES

Infotainment:

- Multimedia Navi Pro system
 - Fully integrated European sat nav system
 - 8-inch colour touchscreen
 - AM/FM/DAB digital radio
 - Bluetooth® audio streaming
 - Bluetooth® mobile phone portal
 - Apple CarPlay™/Android Auto™
 - USB audio connection

- Seven speakers (five front, two rear)
- Bose® premium sound system (2.0 (210PS) BiTurbo D 4X4 models only)

Interior convenience/styling:

- Leather seat facings
- Dual-zone electronic climate control
- Leather-covered steering wheel
- Heated front seats
- 16-way adjustable driver's seat
- Multi-function trip computer
- Cruise control with speed limiter
- Front centre armrest
- Steering wheel audio/phone/cruise controls
- 8-inch colour information display
- Twin rear USB sockets

Exterior convenience/styling:

- 17-inch alloy wheels (1.6 diesel manual models)

- 18-inch alloy wheels (excluding 1.6 diesel manual, 1.6 (200PS) Turbo and 2.0 (210PS) BiTurbo D 4X4 models)
- 20-inch alloy wheels (1.6 (200PS) Turbo and 2.0 (210PS) BiTurbo D 4X4 models)
- IntelliLux LED® matrix headlights
- Rain-sensitive windscreen wipers
- Automatic lighting control with tunnel detection
- Front fog lights
- Dark-tinted rear windows
- Front and rear parking sensors
- Silver-effect roof rails (Sports Tourer models)

Safety/security:

- Driving Assistance Pack One
 - Front camera system
 - Forward collision alert with automatic city emergency braking
 - Following distance indicator
 - Lane departure warning with lane assist
 - Traffic sign recognition
- Electronic Stability Programme (ESP)
- Anti-lock Braking System (ABS)
- Six airbags
- Hill start assist
- ISOFIX child seat mounting points, outer rear seats
- Tyre pressure monitoring system
- Security alarm system (Thatcham approved, T1)

GSi NAV



GSi NAV ON-THE-ROAD PRICES

	Grand Sport		Sports Tourer		Insurance Group
	OTR RRP	CO ₂ (g/km)	OTR RRP	CO ₂ (g/km)	
Diesel					
2.0 (210PS) BiTurbo D 4X4 auto	£38,260	187	£39,760	188	28E

Please note: On-the-road recommended retail prices (RRP) include VAT at 20%, number plates and delivery to Retailer of £700.00 (inc. £116.67 VAT), 12 months' Vehicle Excise Duty and new vehicle first registration fee of £55.00. Excludes fuel and insurance.

FEATURES

Infotainment:

- Multimedia Navi Pro system
 - Fully integrated European sat nav system
 - 8-inch colour touchscreen
 - AM/FM/DAB digital radio
 - Bluetooth® audio streaming
 - Bluetooth® mobile phone portal
 - Apple CarPlay™/Android Auto™
 - USB audio connection
- Bose® premium sound system

Interior convenience/styling:

- Perforated leather seat facings
- Ergonomic AGR active front seats
- Dual-zone electronic climate control
- Heated, flat-bottom leather-covered VX-Line steering wheel
- Heated front and outer rear seats
- Multi-function trip computer
- Cruise control with speed limiter
- Front centre armrest
- Steering wheel audio/phone/cruise controls
- Head-up display
- 8-inch colour information display
- Twin rear USB sockets
- FlexOrganiser® Pack (Sports Tourer models)

Exterior convenience/styling:

- 20-inch alloy wheels

- GSi front and rear bumpers
- GSi side sills
- GSi rear spoiler (Grand Sport models)
- Visible exhaust tailpipes
- IntelliLux LED® matrix headlights
- FlexRide with Competition mode
- Sports chassis
- Rain-sensitive windscreen wipers
- Automatic lighting control with tunnel detection
- Dark-tinted rear windows
- Front and rear parking sensors
- Silver-effect roof rails (Sports Tourer models)

Safety/security:

- Driving Assistance Pack One
 - Front camera system
 - Forward collision alert with automatic city emergency braking
 - Following distance indicator
 - Lane departure warning with lane assist
 - Traffic sign recognition
- Electronic Stability Programme (ESP)
- Anti-lock Braking System (ABS)
- Six airbags
- Hill start assist
- Tyre pressure monitoring system
- Keyless entry and start
- Security alarm system (Thatcham approved, T1)

COUNTRY TOURER



COUNTRY TOURER ON-THE-ROAD PRICES

	Country Tourer		Insurance Group
	OTR RRP	CO ₂ (g/km)	
Petrol			
2.0 (170PS) Turbo D	£27,165	150	20E
2.0 (170PS) Turbo D auto	£29,095	151	20E
2.0 (170PS) Turbo D 4X4	£28,495	164	24E
2.0 (210PS) BiTurbo D 4X4 auto	£30,120	188	24E

Please note: On-the-road recommended retail prices (RRP) include VAT at 20%, number plates and delivery to Retailer of £700.00 (inc. £116.67 VAT), 12 months' Vehicle Excise Duty and new vehicle first registration fee of £55.00. Excludes fuel and insurance.

FEATURES

Infotainment:

- Multimedia Navi system
 - 7-inch colour touchscreen
 - AM/FM/DAB digital radio
 - Bluetooth® audio streaming
 - Bluetooth® mobile phone portal
 - Apple CarPlay™/Android Auto™
 - USB audio connection
- Seven speakers (five front, two rear)
- Bose® premium sound system (2.0 (210PS) BiTurbo D 4X4 models)

Interior convenience/styling:

- Dual-zone electronic climate control
- Leather-covered steering wheel
- 16-way adjustable driver's seat
- Multi-function trip computer
- Cruise control with speed limiter
- Front centre armrest
- Steering wheel audio/phone/cruise controls
- Twin rear USB sockets

Exterior convenience/styling:

- 18-inch alloy wheels
- Anthracite wheel arch and side sill extensions
- Front and rear bumpers incorporating silver-effect skid plates

- FlexRide
- Rain-sensitive windscreen wipers
- Automatic lighting control with tunnel detection
- Front fog lights
- Dark-tinted rear windows
- Electrically adjustable/heated door mirrors
- Front and rear parking sensors
- Silver-effect roof rails

Safety/security:

- Driving Assistance Pack One
 - Front camera system
 - Forward collision alert with automatic city emergency braking
 - Following distance indicator
 - Lane departure warning with lane assist
 - Traffic sign recognition
- Electronic Stability Programme (ESP)
- Anti-lock Braking System (ABS)
- Six airbags
- Hill start assist
- ISOFIX child seat mounting points, outer rear seats
- Tyre pressure monitoring system
- Security alarm system (Thatcham approved, T1)

INSIGNIA GRAND SPORT PRICES

	Price (£)	VAT (£)	Total (£)	On-the-road RRP (£)	BiK 20% (£)	CO ₂ (g/km)
DESIGN						
1.5 (140PS) Turbo	15,850.00	3,170.00	19,020.00	19,945.00	95.30	129
1.5 (165PS) Turbo	16,100.00	3,220.00	19,320.00	20,245.00	96.75	129
1.5 (165PS) Turbo auto	17,433.33	3,486.67	20,920.00	21,885.00	111.70	138
Diesel						
1.6 (110PS) Turbo D	16,150.00	3,230.00	19,380.00	20,345.00	103.73	116
1.6 (136PS) Turbo D	16,566.66	3,313.34	19,880.00	20,845.00	109.75	121
1.6 (136PS) Turbo D auto	17,900.00	3,580.00	21,480.00	22,765.00	129.38	137
DESIGN NAV						
1.5 (140PS) Turbo	16,516.66	3,303.34	19,820.00	20,745.00	99.17	129
1.5 (165PS) Turbo	16,766.66	3,353.34	20,120.00	21,045.00	100.62	129
1.5 (165PS) Turbo auto	18,100.00	3,620.00	21,720.00	22,685.00	115.83	138
Diesel						
1.6 (110PS) Turbo D	16,816.66	3,363.34	20,180.00	21,145.00	107.87	116
1.6 (136PS) Turbo D	17,233.33	3,446.67	20,680.00	21,645.00	114.02	121
1.6 (136PS) Turbo D auto	18,566.66	3,713.34	22,280.00	23,565.00	134.05	137

	Price (£)	VAT (£)	Total (£)	On-the-road RRP (£)	BiK 20% (£)	CO ₂ (g/km)
SRI						
1.5 (165PS) Turbo	18,158.33	3,631.67	21,790.00	22,715.00	108.70	129
1.5 (165PS) Turbo auto	19,491.66	3,898.34	23,390.00	24,355.00	124.45	138
Diesel						
1.6 (110PS) Turbo D	18,208.33	3,641.67	21,850.00	22,815.00	116.50	116
1.6 (136PS) Turbo D	18,625.00	3,725.00	22,350.00	23,315.00	122.93	121
1.6 (136PS) Turbo D auto	19,958.33	3,991.67	23,950.00	25,235.00	143.78	137
2.0 (170PS) Turbo D	19,291.66	3,858.34	23,150.00	24,435.00	143.10	141
2.0 (170PS) Turbo D auto	20,625.00	4,125.00	24,750.00	26,035.00	156.93	146
SRI NAV						
1.5 (165PS) Turbo	18,816.66	3,763.34	22,580.00	23,505.00	112.52	129
1.5 (165PS) Turbo auto	20,150.00	4,030.00	24,180.00	25,145.00	128.53	138
Diesel						
1.6 (110PS) Turbo D	18,866.66	3,773.34	22,640.00	23,605.00	120.58	116
1.6 (136PS) Turbo D	19,283.33	3,856.67	23,140.00	24,105.00	127.13	121
1.6 (136PS) Turbo D auto	20,616.66	4,123.34	24,740.00	26,025.00	148.40	137
2.0 (170PS) Turbo D	19,950.00	3,990.00	23,940.00	25,225.00	147.83	141
2.0 (170PS) Turbo D auto	21,283.33	4,256.67	25,540.00	26,825.00	161.80	146

All diesel models feature BlueInjection. Vehicles with BlueInjection technology will need regular AdBlue® top-ups also between servicing requirements. An indicator integrated into the on-board computer will warn you when you need to top up. More information under www.vauxhall.co.uk/adblue. In accordance with regulations R (EC) No. 715/2007 and R (EC) No. 692/2008 (in the versions respectively applicable).

Please note: On-the-road recommended retail prices (RRP) include number plates and delivery to retailer of £700.00 (inc. £116.67 VAT), 12 months' Vehicle Excise Duty and new vehicle first registration fee of £55.00. Excludes fuel and insurance. Company Car Benefit in Kind (BiK) rates are monthly based on the standard paint price.

INSIGNIA GRAND SPORT PRICES CONTINUED

	Price (£)	VAT (£)	Total (£)	On-the-road RRP (£)	BiK 20% (£)	CO ₂ (g/km)
SRI VX-LINE NAV						
1.5 (165PS) Turbo	19,833.33	3,966.67	23,800.00	24,725.00	118.42	126
1.5 (165PS) Turbo auto	21,166.66	4,233.34	25,400.00	26,365.00	134.85	135
1.6 (200PS) Turbo	21,083.33	4,216.67	25,300.00	26,265.00	143.00	145
1.6 (200PS) Turbo auto	23,625.00	4,725.00	28,350.00	29,635.00	164.62	153
Diesel						
1.6 (136PS) Turbo D	20,300.00	4,060.00	24,360.00	25,325.00	133.65	121
1.6 (136PS) Turbo D auto	21,633.33	4,326.67	25,960.00	27,245.00	155.52	137
2.0 (170PS) Turbo D	20,966.66	4,193.34	25,160.00	26,445.00	150.85	138
2.0 (170PS) Turbo D auto	22,300.00	4,460.00	26,760.00	28,045.00	164.75	144
TECH LINE NAV						
1.5 (165PS) Turbo	18,650.00	3,730.00	22,380.00	23,305.00	111.55	129
1.5 (165PS) Turbo auto	19,983.33	3,996.67	23,980.00	24,945.00	127.50	138
Diesel						
1.6 (110PS) Turbo D	18,700.00	3,740.00	22,440.00	23,405.00	119.55	116
1.6 (136PS) Turbo D	19,116.66	3,823.34	22,940.00	23,905.00	126.07	121
1.6 (136PS) Turbo D auto	20,450.00	4,090.00	24,540.00	25,825.00	147.23	137
2.0 (170PS) Turbo D	19,783.33	3,956.67	23,740.00	25,025.00	146.63	141
2.0 (170PS) Turbo D auto	21,116.66	4,223.34	25,340.00	26,625.00	160.57	146

	Price (£)	VAT (£)	Total (£)	On-the-road RRP (£)	BiK 20% (£)	CO ₂ (g/km)
ELITE NAV						
1.5 (165PS) Turbo	21,341.66	4,268.34	25,610.00	26,535.00	127.15	126
1.5 (165PS) Turbo auto	22,675.00	4,535.00	27,210.00	28,175.00	144.20	135
1.6 (200PS) Turbo	22,591.67	4,518.33	27,110.00	28,075.00	152.95	145
1.6 (200PS) Turbo auto	24,633.33	4,926.67	29,560.00	30,845.00	171.47	153
Diesel						
1.6 (110PS) Turbo D	21,391.66	4,278.34	25,670.00	26,635.00	136.23	116
1.6 (136PS) Turbo D	21,808.33	4,361.67	26,170.00	27,135.00	143.30	121
1.6 (136PS) Turbo D auto	23,141.66	4,628.34	27,770.00	29,055.00	166.07	137
2.0 (170PS) Turbo D	22,475.00	4,495.00	26,970.00	28,255.00	161.40	138
2.0 (170PS) Turbo D auto	23,808.33	4,761.67	28,570.00	29,855.00	175.62	144
2.0 (210PS) BiTurbo D 4X4 auto	24,304.16	4,860.84	29,165.00	31,200.00	184.17	184
GSI NAV						
Diesel						
2.0 (210PS) BiTurbo D 4X4 auto	30,187.50	6,037.50	36,225.00	38,260.00	227.70	187

All diesel models feature BlueInjection. Vehicles with BlueInjection technology will need regular AdBlue® top-ups also between servicing requirements. An indicator integrated into the on-board computer will warn you when you need to top up. More information under www.vauxhall.co.uk/adblue. In accordance with regulations R (EC) No. 715/2007 and R (EC) No. 692/2008 (in the versions respectively applicable).

Please note: On-the-road recommended retail prices (RRP) include number plates and delivery to retailer of £700.00 (inc. £116.67 VAT), 12 months' Vehicle Excise Duty and new vehicle first registration fee of £55.00. Excludes fuel and insurance. Company Car Benefit in Kind (BiK) rates are monthly based on the standard paint price.

INSIGNIA SPORTS TOURER PRICES

	Price (£)	VAT (£)	Total (£)	On-the-road RRP (£)	BiK 20% (£)	CO ₂ (g/km)
DESIGN						
1.5 (140PS) Turbo	17,116.66	3,423.34	20,540.00	21,505.00	106.20	131
1.5 (165PS) Turbo	17,366.66	3,473.34	20,840.00	21,805.00	107.70	131
1.5 (165PS) Turbo auto	18,700.00	3,740.00	22,440.00	23,405.00	123.40	144
Diesel						
1.6 (110PS) Turbo D	17,400.00	3,480.00	20,880.00	21,845.00	115.08	121
1.6 (136PS) Turbo D	17,816.66	3,563.34	21,380.00	22,345.00	121.43	125
1.6 (136PS) Turbo D auto	19,150.00	3,830.00	22,980.00	24,265.00	138.13	139
2.0 (170PS) Turbo D	18,483.33	3,696.67	22,180.00	23,465.00	141.08	145
2.0 (170PS) Turbo D auto	19,816.66	3,963.34	23,780.00	25,065.00	150.95	148
DESIGN NAV						
1.5 (140PS) Turbo	17,783.33	3,556.67	21,340.00	22,305.00	110.20	131
1.5 (165PS) Turbo	18,033.33	3,606.67	21,640.00	22,605.00	111.70	131
1.5 (165PS) Turbo auto	19,366.66	3,873.34	23,240.00	24,205.00	127.67	144
Diesel						
1.6 (110PS) Turbo D	18,066.67	3,613.33	21,680.00	22,645.00	119.35	121
1.6 (136PS) Turbo D	18,483.33	3,696.67	22,180.00	23,145.00	125.83	125
1.6 (136PS) Turbo D auto	19,816.66	3,963.34	23,780.00	25,065.00	142.80	139
2.0 (170PS) Turbo D	19,150.00	3,830.00	22,980.00	24,265.00	146.02	145
2.0 (170PS) Turbo D auto	20,483.33	4,096.67	24,580.00	25,865.00	155.88	148

	Price (£)	VAT (£)	Total (£)	On-the-road RRP (£)	BiK 20% (£)	CO ₂ (g/km)
SRI						
1.5 (165PS) Turbo	19,425.00	3,885.00	23,310.00	24,275.00	120.05	131
1.5 (165PS) Turbo auto	20,758.33	4,151.67	24,910.00	25,875.00	136.58	144
Diesel						
1.6 (110PS) Turbo D	19,458.33	3,891.67	23,350.00	24,315.00	128.27	121
1.6 (136PS) Turbo D	19,875.00	3,975.00	23,850.00	24,815.00	135.02	125
1.6 (136PS) Turbo D auto	21,208.33	4,241.67	25,450.00	26,735.00	152.53	139
2.0 (170PS) Turbo D	20,541.66	4,108.34	24,650.00	25,935.00	156.32	145
2.0 (170PS) Turbo D auto	21,875.00	4,375.00	26,250.00	27,535.00	166.18	148
SRI NAV						
1.5 (165PS) Turbo	20,083.33	4,016.67	24,100.00	25,065.00	124.00	131
1.5 (165PS) Turbo auto	21,416.66	4,283.34	25,700.00	26,665.00	140.80	144
Diesel						
1.6 (110PS) Turbo D	20,116.67	4,023.33	24,140.00	25,105.00	132.47	121
1.6 (136PS) Turbo D	20,533.33	4,106.67	24,640.00	25,605.00	139.37	125
1.6 (136PS) Turbo D auto	21,866.66	4,373.34	26,240.00	27,525.00	157.15	139
2.0 (170PS) Turbo D	21,200.00	4,240.00	25,440.00	26,725.00	161.18	145
2.0 (170PS) Turbo D auto	22,533.33	4,506.67	27,040.00	28,325.00	171.05	148

All diesel models feature BlueInjection. Vehicles with BlueInjection technology will need regular AdBlue® top-ups also between servicing requirements. An indicator integrated into the on-board computer will warn you when you need to top up. More information under www.vauxhall.co.uk/adblue. In accordance with regulations R (EC) No. 715/2007 and R (EC) No. 692/2008 (in the versions respectively applicable).

Please note: On-the-road recommended retail prices (RRP) include number plates and delivery to retailer of £700.00 (inc. £116.67 VAT), 12 months' Vehicle Excise Duty and new vehicle first registration fee of £55.00. Excludes fuel and insurance. Company Car Benefit in Kind (BiK) rates are monthly based on the standard paint price.

INSIGNIA SPORTS TOURER PRICES CONTINUED

	Price (£)	VAT (£)	Total (£)	On-the-road RRP (£)	BiK 20% (£)	CO ₂ (g/km)
SRI VX-LINE NAV						
1.5 (165PS) Turbo	21,133.33	4,226.67	25,360.00	26,285.00	130.10	128
1.5 (165PS) Turbo auto	22,433.33	4,486.67	26,920.00	27,885.00	147.30	140
1.6 (200PS) Turbo	22,350.00	4,470.00	26,820.00	28,105.00	155.93	151
1.6 (200PS) Turbo auto	24,891.67	4,978.33	29,870.00	31,155.00	173.22	154
Diesel						
1.6 (136PS) Turbo D	21,550.00	4,310.00	25,860.00	26,825.00	146.07	125
1.6 (136PS) Turbo D auto	22,883.33	4,576.67	27,460.00	28,745.00	164.27	139
2.0 (170PS) Turbo D	22,216.66	4,443.34	26,660.00	27,945.00	168.72	142
2.0 (170PS) Turbo D auto	23,550.00	4,710.00	28,260.00	29,545.00	178.58	147
TECH LINE NAV						
1.5 (165PS) Turbo	19,916.66	3,983.34	23,900.00	24,865.00	123.00	131
1.5 (165PS) Turbo auto	21,250.00	4,250.00	25,500.00	26,465.00	139.73	144
Diesel						
1.6 (110PS) Turbo D	19,950.00	3,990.00	23,940.00	24,905.00	131.40	121
1.6 (136PS) Turbo D	20,366.67	4,073.33	24,440.00	25,405.00	138.27	125
1.6 (136PS) Turbo D auto	21,700.00	4,340.00	26,040.00	27,325.00	155.98	139
2.0 (170PS) Turbo D	21,033.33	4,206.67	25,240.00	26,525.00	159.95	145
2.0 (170PS) Turbo D auto	22,366.66	4,473.34	26,840.00	28,125.00	169.82	148

	Price (£)	VAT (£)	Total (£)	On-the-road RRP (£)	BiK 20% (£)	CO ₂ (g/km)
ELITE NAV						
1.5 (165PS) Turbo	22,641.67	4,528.33	27,170.00	28,095.00	134.70	128
1.5 (165PS) Turbo auto	23,941.66	4,788.34	28,730.00	29,695.00	156.95	140
1.6 (200PS) Turbo	23,858.33	4,771.67	28,630.00	29,915.00	166.20	151
1.6 (200PS) Turbo auto	25,900.00	5,180.00	31,080.00	32,365.00	180.08	154
Diesel						
1.6 (110PS) Turbo D	22,641.66	4,528.34	27,170.00	28,135.00	148.63	121
1.6 (136PS) Turbo D	23,058.33	4,611.67	27,670.00	28,635.00	156.03	125
1.6 (136PS) Turbo D auto	24,391.66	4,878.34	29,270.00	30,555.00	174.82	139
2.0 (170PS) Turbo D	23,725.00	4,745.00	28,470.00	29,755.00	175.02	142
2.0 (170PS) Turbo D auto	25,058.33	5,011.67	30,070.00	31,355.00	189.73	147
2.0 (210PS) BiTurbo D 4X4 auto	25,554.16	5,110.84	30,665.00	32,700.00	193.42	187
GSi NAV						
Diesel						
2.0 (210PS) BiTurbo D 4X4 auto	31,437.50	6,287.50	37,725.00	39,760.00	236.95	188

All diesel models feature BlueInjection. Vehicles with BlueInjection technology will need regular AdBlue® top-ups also between servicing requirements. An indicator integrated into the on-board computer will warn you when you need to top up. More information under www.vauxhall.co.uk/adblue. In accordance with regulations R (EC) No. 715/2007 and R (EC) No. 692/2008 (in the versions respectively applicable).

Please note: On-the-road recommended retail prices (RRP) include number plates and delivery to retailer of £700.00 (inc. £116.67 VAT), 12 months' Vehicle Excise Duty and new vehicle first registration fee of £55.00. Excludes fuel and insurance. Company Car Benefit in Kind (BiK) rates are monthly based on the standard paint price.

INSIGNIA COUNTRY TOURER PRICES

	Price (£)	VAT (£)	Total (£)	On-the-road RRP (£)	BiK 20% (£)	CO ₂ (g/km)
COUNTRY TOURER						
Diesel						
2.0 (170PS) Turbo D	21,566.66	4,313.34	25,880.00	27,165.00	163.90	150
2.0 (170PS) Turbo D auto	22,904.17	4,580.83	27,485.00	29,095.00	173.80	151
2.0 (170PS) Turbo D 4X4	22,404.17	4,480.83	26,885.00	28,495.00	170.10	164
2.0 (210PS) BiTurbo D 4X4 auto	23,404.17	4,680.83	28,085.00	30,120.00	177.50	188

All diesel models feature BlueInjection. Vehicles with BlueInjection technology will need regular AdBlue® top-ups also between servicing requirements. An indicator integrated into the on-board computer will warn you when you need to top up. More information under www.vauxhall.co.uk/adblue. In accordance with regulations R (EC) No. 715/2007 and R (EC) No. 692/2008 (in the versions respectively applicable).

Please note: On-the-road recommended retail prices (RRP) include number plates and delivery to retailer of £700.00 (inc. £116.67 VAT), 12 months' Vehicle Excise Duty and new vehicle first registration fee of £55.00. Excludes fuel and insurance. Company Car Benefit in Kind (BiK) rates are monthly based on the standard paint price.

STANDARD FEATURES

ALL MODELS

Driver/passenger airbags

- Driver's airbag • Front passenger's airbag • Two front seat side-impact airbags
 - Full-size curtain airbags for driver and front and outer rear seat passengers
-

Seating

- Height-adjustable front seat head restraints (excluding GSi Nav models)
 - Three height adjustable rear seat head restraints
 - Anti-submarining ramps in front seats – Prevents occupants sliding underneath the lap belt during a collision.
-

Seatbelts

- Two front and three rear inertia-reel lap and diagonal seatbelts
 - Front and outer rear seatbelt pretensioner system – Pretensioners tighten the seatbelt in the event of an accident limiting forward movement.
 - Front and outer rear seatbelt force limiters – Reduces potential upper body injuries during a frontal impact.
 - Front 'seatbelt unfastened' audible warning and warning light
-

Child safety

- Deactivation switch for front passenger's front and side-impact airbags – Permits the safe use of a child seat in the front passenger seat. • ISOFIX child seat mountings incorporating top tether anchor points located on outer rear seats (does not include child seat) – Allows ISOFIX child safety seats to be securely fixed into the car. The ISOFIX mounting system reduces forward movement in an accident and makes the child seat easier to install.
 - Child-proof locks on rear doors
-

Driver/passenger safety

- Energy-absorbing steering column
 - Pedal release system – Reduces potential injury to the driver's legs and feet during a severe frontal impact.
 - Laminated windscreen • Side-impact protection beams • Reinforced passenger safety cell
 - Deformation zones front and rear • Burst-proof door locks and anti-jam door design
-

Pedestrian safety

- Active bonnet/headlight/wiper structure – Designed to reduce pedestrian head and upper body injuries. The active bonnet travels backwards and upwards to help prevent impact between pedestrian's head and underbonnet components.
 - Upper and lower bumper design – Reduces upper and lower leg injuries.
-

Stability

- Electronic Stability Programme (ESP) – Works in conjunction with the vehicle's electronic braking and engine systems to keep the car stable in many different situations. ESP monitors many different inputs to determine when the car starts to lose traction, it can then immediately respond by varying the brake pressure between up to three wheels and adjust the engine output to help correct the loss of traction and improve stability.

Additional ESP features:

- Traction control • Cornering brake control • Straight line stability control • Rollover mitigation
 - Drag torque control – Maintain stability on slippery roads when lifting off the accelerator or changing gear.
-

Braking

- Anti-lock Braking System (ABS) – Prevents the vehicle's wheels from locking up under heavy braking by momentarily reducing brake pressure at the appropriate wheel, ensuring that you can maintain control of the steering.

Additional ESP features:

The same electronic systems used in the ABS and ESP also deliver exceptional braking performance.

- Emergency brake assist – When emergency braking is detected the vehicle automatically applies the maximum possible braking assistance.
 - Fading brake support – Compensates for the effects of brake fade • Electronic brakeforce distribution – Automatically apportions the optimum braking force to each wheel.
 - Adaptive brake lights – Automatically warns other road users of heavy braking.
 - Hill start assist – Briefly maintains rear brake pressure to stop the vehicle rolling back on an incline.
 - Hazard warning lights
-

Tyre pressure

- Tyre pressure monitoring system
-

STANDARD FEATURES

ALL MODELS

Electric parking brake

- Centre console switch in lieu of handbrake lever
 - Premium centre console featuring adjustable armrest
-

Steering

- Speed-sensitive electrically assisted power steering
-

Cruise control with speed limiter

Cruise control enables you to maintain a constant speed – making it ideal for economical motorway driving. The speed limiter function can be set to ensure that you do not exceed the speed limit and can be easily overridden if required.

- Steering wheel mounted controls
-

Standard security features

- Keyless start with engine start/stop button
 - Electronically protected audio equipment
 - Engine deadlock immobiliser
 - Visible Vehicle Identification Number (VIN)
 - Locking wheel bolts for alloy wheels
 - Freewheeling door locks
-

Remote control central locking

- Operates on doors, tailgate and fuel filler flap
 - Deadlocking
 - Central locking activation switch on driver's door
-

Remote control ultrasonic security alarm system

- Remote control (operates in conjunction with central locking)
 - Ultrasonic interior sensors
 - Tilt sensor
 - Independent power supply
 - Thatcham approved (T1)
-

Instrumentation

- Speedometer
 - Rev counter
 - Digital fuel gauge with low fuel level warning light
 - Digital water temperature gauge with warning light
 - Shift-up/down indication light – Indicates when to change gear for optimum fuel economy.
-

Driver information display (centrally located in instrument cluster)

- Trip computer data
 - Total mileage
 - Service-due indicator
 - Oil life
 - Tyre pressure monitoring system
-

Multi-function trip computer (displayed on driver information display)

- Trip mileage
 - Vehicle range based on remaining fuel
 - Average speed
 - Average fuel economy
 - Instantaneous fuel economy
 - Driving time
-

Central fascia display (format dependent on infotainment unit)

- Audio information
 - Digital clock with automatic RDS time adjustment
 - Outside air temperature with ice warning function
 - Additional features dependent on infotainment unit (see infotainment for details)
-

Seating and comfort

- Reach and rake adjustable steering
 - Steering wheel mounted audio controls
-

Rear seating

- Three person layout
 - Three height-adjustable and removable head restraints
 - ISOFIX child seat mountings incorporating top tether anchor points located on outer rear seats (does not include child seat) – Allows ISOFIX child safety seats to be securely fixed into the car. The ISOFIX mounting system reduces forward movement in an accident and makes the child seat easier to install.
 - Child-proof locks on rear doors
-

Heating and ventilation

- Four adjustable fascia vents
 - Windscreen demist vents
 - Side window demist vents
-

Convenience features

- Front 12-volt electrical accessory socket
 - Driver's and front passengers sunvisors
 - Driver's and front passenger's vanity mirrors
 - Dipping rear-view mirror
-

Interior lighting

- Central front courtesy light
 - Central rear courtesy light
 - Fade up/fade down
 - Twin front reading lights with illuminated switches
 - Twin rear reading lights
 - Ambient LED fascia/centre console downlighter
-

Interior storage

- Illuminated glovebox with lid
 - Front door pockets with 1.5-litre bottle holder
 - Two drinks holders in centre console
 - Rear door pockets with 1-litre bottle holder
 - Front centre adjustable armrest with 4-litre storage capacity (2.8 litres if optional wireless charger is ordered)
-

Luggage area

- Luggage compartment cover (Grand Sport models)
 - Luggage compartment retractable cover (Sports Tourer/Country Tourer models)
 - Illuminated load area
 - Fully carpeted load area
 - Interior tailgate handle
 - Four load restraint lashing eyes
 - Twin gas-assisted tailgate struts
 - Storage tray in spare wheel well
-

STANDARD FEATURES

ALL MODELS

Exterior lighting features

- LED daytime running lights • LED tail lights
 - Automatic lighting control: When the automatic lighting control is switched on, the system switches between daytime running lights and headlights automatically depending on external lighting conditions.
 - LED side repeat indicators
 - Lights-on audible warning: When driver's door is opened an audible warning sounds to alert the lights have been left on.
 - Manual headlight beam levelling: Use to adapt headlight range to the vehicle load to prevent dazzling.
 - LED brake lights • High-level LED centre rear brake light • Rear fog light • Reversing light
 - Hazard warning lights
 - Door-to-door illumination: Headlights illuminate the area for an adjustable time after leaving the vehicle.
 - Welcome lighting: Headlights and tail lights illuminate when the vehicle is unlocked.
-

Windscreen wipers

- Two-speed windscreen wipers with variable intermittent wipe
 - Intermittent rear window wash/wipe (Sports Tourer/Country Tourer models)
-

Door mirrors

- Twin electrically adjustable/heated door mirrors • Manually folding door mirrors
-

Windows

- Electrically operated front and rear windows with safety autoreverse and one-touch up/down facility
 - Heated rear window • Solar heat-absorbing windscreen • Tinted windows
-

Body styling

- Chrome-effect front grille bar • Body-colour door mirrors
 - Chrome-effect upper window trim (excluding Design Grand Sport models)
 - Body-colour door handles
-

FEATURES/OPTIONS

DRIVER ASSISTANCE

	Design/ Design Nav	SRi/ SRi Nav	SRi VX-Line Nav	Tech Line Nav	Elite Nav	GSi Nav	Country Tourer	Price (£) exc. VAT	Price (£) inc. VAT
<p>Driving Assistance Pack One</p> <p>A wide range of class-leading driver assistance and safety features are controlled by the front camera system</p> <p>Forward collision alert with automatic city emergency braking In certain circumstances and at speeds above 5mph warns when approaching another vehicle too quickly. At speeds above 5mph and up to 50mph the system provides additional braking support to help the driver brake more quickly and effectively in an emergency situation. On dry roads at speeds above 5mph and up to 25mph the vehicle can brake to a full stop. At speeds above 25mph and up to 50mph, if no avoiding action is taken by the driver, the system automatically slows the vehicle with emergency braking.</p> <ul style="list-style-type: none"> • Visual warnings – red LEDs projected onto windscreen and visual warning shown in the instrument cluster. • Audible warning • Additional braking support • Low speed collision mitigation braking <p>Following distance indicator Indicates how many seconds you are behind the vehicle in front – helping you maintain a safe distance.</p> <ul style="list-style-type: none"> • Timings are shown in the driver information display • Warning light in the instrument cluster if the gap to the vehicle ahead is below that set by the driver <p>Lane departure warning with lane assist If the driver has not actively steered or signalled, the lane departure warning system warns when the car moves outside of lane markings at speeds above 35mph. The lane assist function additionally provides gentle steering correction to help drivers keep in their lane if no active inputs are made.</p> <ul style="list-style-type: none"> • Warning light in the instrument cluster • Audible warning • Steering wheel ‘nudge’ warning • Facia on/off switch 	●	●	●	●	●	●	●		
<p>FlexRide (available at extra cost on 2.0 (170PS) Turbo D, standard 1.6 (200PS) Turbo auto and 2.0 (210PS) BiTurbo D 4X4 models)</p> <p>Enables the driver to choose from three distinct driving modes – Normal (default setting), Sport or Tour.</p> <ul style="list-style-type: none"> • Facia mounted Sport and Tour switches • GSi models include a unique Competition mode 	○	○	○	○	○	●	●	708.33	850.00
<p>Driving Assistance Pack Two – Automatic cruise control incorporating automatic brake intervention (not available on 1.6 (110/136) Turbo D models)</p> <p>Automatic cruise control adjusts the vehicle’s speed to maintain a time distance to the preceding vehicle, up to the speed that you have set. On models with automatic transmission the ‘Stop and Go’ function will bring the vehicle to a complete stop and then set off again as the traffic ahead moves away. Automatic brake intervention is active at all speeds above walking pace (2.5mph).</p>		○	○	○	○	○	○	475.00	570.00

● = Standard equipment. ○ = Optional at extra cost.

FEATURES/OPTIONS

DRIVER ASSISTANCE CONTINUED

	Design/ Design Nav	SRI/ SRI Nav	SRI VX-Line Nav	Tech Line Nav	Elite Nav	GSI Nav	Country Tourer	Price (£) exc. VAT	Price (£) inc. VAT
<p>Driving Assistance Pack Three (only available on Nav models and in conjunction with Power Seat Pack. Includes front and rear parking distance sensors)</p> <p>Intelligent ultrasonic sensors form part of the solution for today's crowded roads and car parks – delivering exceptional assistance both when parking and protecting you on the open road.</p> <ul style="list-style-type: none"> Electrically foldable door mirrors with puddle lights <p>Advanced park assist</p> <p>Advanced park assist not only detects suitable parking spaces but also expertly steers into them for you. All you have to do is to drive forward or reverse. The system works with both parallel and bay parking.</p> <ul style="list-style-type: none"> Ultrasonic side sensors with four-metre range Ultrasonic front and rear parking sensors with a two-metre range Fully automated steering On automatic models, braking is automated Detailed forward/reverse instructions are shown in the instrument cluster or central facia display <p>Lane change assist with side blind spot alert</p> <p>Lane change assist with side blind spot alert helps prevent potential collisions with other vehicles 'hidden' in the vehicle's side blind spots. If a vehicle enters one of the blind spots a warning light illuminates in the relevant door mirror.</p> <ul style="list-style-type: none"> Ultrasonic side sensors identify vehicles within three-metre range LED warning light in door mirrors, flashes when indicators are used Audible warning is sounded if the indicators are used and the system has detected another vehicle Radar sensors with 70-metre range identify traffic approaching quickly from behind <p>360° panoramic camera</p> <p>The camera gives a clear view of the area all around your car and helps place the car perfectly, without needing to strain your neck.</p> <ul style="list-style-type: none"> Activated when reverse gear selected, when switched on manually or when very close to an object ahead of or behind the vehicle Camera views appear in infotainment screen Overhead view displayed on the left side of the screen allows you to see clearly how close you are to obstacles in front of and behind you Right side of the screen displays front or rear view, depending on gear selected Rear bumper and grid lines shown as reference points <p>Rear cross traffic alert</p> <p>As you reverse the car, this system detects vehicles approaching from the rear and side.</p> <ul style="list-style-type: none"> Radar sensors with 20-metre range identify approaching vehicles Warning light in central facia display Audible warning on relevant side of car 								854.17	1,025.00

○ = Optional at extra cost.

FEATURES/OPTIONS

DRIVER ASSISTANCE CONTINUED

	Design/ Design Nav	SRI/ SRI Nav	SRI VX-Line Nav	Tech Line Nav	Elite Nav	GSi Nav	Country Tourer	Price (£) exc. VAT	Price (£) inc. VAT
<p>Driving Assistance Pack Four (only available on Nav models. Design Nav models require optional Sight and Light Pack. Includes front and rear parking distance sensors. Not available with optional power driver's seat)</p> <p>Intelligent ultrasonic sensors form part of the solution for today's crowded roads and car parks – delivering exceptional assistance both when parking and protecting you on the open road.</p> <ul style="list-style-type: none"> Electrically foldable door mirrors with puddle lights <p>Lane change assist with side blind spot alert</p> <p>Lane change assist with side blind spot alert helps prevent potential collisions with other vehicles 'hidden' in the vehicle's side blind spots. If a vehicle enters one of the blind spots a warning light illuminates in the relevant door mirror.</p> <ul style="list-style-type: none"> Ultrasonic side sensors identify vehicles within three-metre range LED warning light in door mirrors, flashes when indicators are used Audible warning is sounded if the indicators are used and the system has detected another vehicle Radar sensors with 70-metre range identify traffic approaching quickly from behind <p>Rear-view camera</p> <p>The rear-view camera gives a clear view of the area behind your car and helps place the car perfectly, without needing to strain your neck.</p> <ul style="list-style-type: none"> Activated when reverse gear selected Camera view appears in infotainment screen Rear bumper and grid lines shown as reference points <p>Rear cross traffic alert</p> <p>As you reverse the car, this system detects vehicles approaching from the rear and side.</p> <ul style="list-style-type: none"> Radar sensors with 20-metre range identify approaching vehicles Warning light in central facia display Audible warning on relevant side of car 	○	○	○	○	○	○	○	541.67	650.00
<p>Front and rear parking distance sensors (not available with Driving Assistance Pack Three or Four)</p> <ul style="list-style-type: none"> Audible warning Distance warning graphic shown in driver information display 	○	●	●	●	●	●	●	383.33	460.00

○ = Optional at extra cost.

FEATURES/OPTIONS

SECURITY

	Design/ Design Nav	SRI/ SRI Nav	SRI VX-Line Nav	Tech Line Nav	Elite Nav	GSI Nav	Country Tourer	Price (£) exc. VAT	Price (£) inc. VAT
Keyless entry with two transmitter fobs	○	○	○	○	○	●	○	250.00	300.00

DRIVER INFORMATION

Driver information display (centrally located in instrument cluster) • 3.5-inch monochrome display	●	●	●	●			●		
• 8-inch colour display incorporating speedometer and supplementary audio, phone and navigation information (standard on 1.6 (200PS) Automatic models)	□	□	□	□	●	●	□		
Head-up display (only available with Multimedia Navi Pro) Projects key information onto the windscreen so that the driver's eyes remain on the road at all times. The display is adjustable for height and brightness. Displays: • Navigation directions • Audio and phone information • Speedometer • Rev counter • Selected gear and gear shift indicator • Set speed of cruise control and speed limiter • Forward collision alert • Following distance indicator gap adjustment • Lane assist and lane departure warning • Pedestrian alert Please note: The red LEDs of the forward collision alert system are replaced by a warning symbol		○	○	○	○	●	○	241.67	290.00

INTERIOR STYLING

Design interior décor Steering wheel: • Three-spoke design • Leather-covered • Satin chrome-effect bezel Facia and door trim: • Black facia • Black door panels with black Atlantis cloth inserts • Metallic silver Raute trim inserts • Chrome-effect interior door handles Headlining: • Light fabric	●								
--	---	--	--	--	--	--	--	--	--

● = Standard equipment. ○ = Optional at extra cost. □ = Available as part of an extra-cost option pack.

FEATURES/OPTIONS

INTERIOR STYLING CONTINUED

	Design/ Design Nav	SRI/ SRI Nav	SRI VX-Line Nav	Tech Line Nav	Elite Nav	GSI Nav	Country Tourer	Price (£) exc. VAT	Price (£) inc. VAT
<p>SRI interior décor</p> <p>Steering wheel:</p> <ul style="list-style-type: none"> • Three-spoke design • Leather-covered, perforated • Satin chrome-effect bezel <p>Facia and door trim:</p> <ul style="list-style-type: none"> • Black facia • Silver air vent surrounds • Black door panels with black premium leather-effect inserts (standard seats); black leather-effect inserts (optional AGR active seats) • Dark metallic Hexagon trim inserts • Chrome-effect interior door handles <p>Pedals:</p> <ul style="list-style-type: none"> • Sports, alloy-effect <p>Headlining:</p> <ul style="list-style-type: none"> • Light fabric 		●							
<p>SRI VX-Line Nav interior décor</p> <p>Steering wheel:</p> <ul style="list-style-type: none"> • Three-spoke VX-Line design, flat bottom • Leather-covered, perforated • Electrically heated • Satin chrome-effect bezel <p>Facia and door trim:</p> <ul style="list-style-type: none"> • Black facia • Silver air vent surrounds • Black door panels with black premium leather-effect inserts (standard seats); black leather-effect inserts (optional AGR active seats) • Dark metallic Hexagon trim inserts • Chrome-effect interior door handles <p>Pedals:</p> <ul style="list-style-type: none"> • Sports, alloy-effect <p>Headlining:</p> <ul style="list-style-type: none"> • Dark fabric 			●						

● = Standard equipment.

FEATURES/OPTIONS

INTERIOR STYLING CONTINUED

	Design/ Design Nav	SRI/ SRI Nav	SRI VX-Line Nav	Tech Line Nav	Elite Nav	GSI Nav	Country Tourer	Price (£) exc. VAT	Price (£) inc. VAT
<p>Tech Line Nav/Country Tourer interior décor</p> <p>Steering wheel:</p> <ul style="list-style-type: none"> • Three-spoke design • Leather-covered • Satin chrome-effect bezel <p>Facia and door trim:</p> <ul style="list-style-type: none"> • Black facia • Black door panels with black leather-effect inserts • Dark silver Agate trim inserts • Chrome-effect interior door handles <p>Headlining:</p> <ul style="list-style-type: none"> • Light fabric <p>Floor mats:</p> <ul style="list-style-type: none"> • Velour, front and rear (Country Tourer models only) <p>Front door sill covers:</p> <ul style="list-style-type: none"> • Alloy-effect 				●			●		
<p>Elite Nav interior décor</p> <p>Steering wheel:</p> <ul style="list-style-type: none"> • Three-spoke design • Leather-covered • Satin chrome-effect bezel <p>Facia and door trim:</p> <ul style="list-style-type: none"> • Black facia • Silver air vent surrounds • Black door panels with black leather-effect inserts • Dark silver Agate trim inserts • Chrome-effect interior door handles <p>Headlining:</p> <ul style="list-style-type: none"> • Light fabric <p>Front door sill covers:</p> <ul style="list-style-type: none"> • Alloy-effect 					●				

● = Standard equipment.

FEATURES/OPTIONS

INTERIOR STYLING CONTINUED

	Design/ Design Nav	SRi/ SRi Nav	SRi VX-Line Nav	Tech Line Nav	Elite Nav	GSi Nav	Country Tourer	Price (£) exc. VAT	Price (£) inc. VAT
<p>GSi Nav interior décor</p> <p>Steering wheel:</p> <ul style="list-style-type: none"> • Three-spoke VX-Line design, flat bottom • Leather-covered, perforated • Electrically heated • Satin chrome-effect bezel <p>Facia and door trim:</p> <ul style="list-style-type: none"> • Black facia • Silver air vent surrounds • Black door panels with black leather-effect inserts • Dark metallic Hexagon trim inserts • Chrome-effect interior door handles <p>Pedals:</p> <ul style="list-style-type: none"> • Sports, alloy-effect <p>Headlining:</p> <ul style="list-style-type: none"> • Dark fabric <p>Floor mats:</p> <ul style="list-style-type: none"> • Velour, front and rear <p>Front door sill covers:</p> <ul style="list-style-type: none"> • Alloy-effect 						●			
<p>VX-Line Interior Pack</p> <hr/> <p>Steering wheel:</p> <ul style="list-style-type: none"> • Three-spoke VX-Line design, flat bottom • Leather-covered, perforated • Electrically heated • Satin chrome-effect bezel • Paddle shift on automatic models <p>Pedals:</p> <ul style="list-style-type: none"> • Sports, alloy-effect <p>Headlining:</p> <ul style="list-style-type: none"> • Dark fabric 		○	●	○	○	●	○	337.50	405.00

● = Standard equipment. ○ = Optional at extra cost.

FEATURES/OPTIONS

SEATING AND COMFORT

	Design/ Design Nav	SRI/ SRI Nav	SRI VX-Line Nav	Tech Line Nav	Elite Nav	GSI Nav	Country Tourer	Price (£) exc. VAT	Price (£) inc. VAT
<p>Cloth front seats</p> <p>Driver's seat (eight-way adjustable):</p> <ul style="list-style-type: none"> • Height • Reach • Backrest • Head restraint <p>Front passenger's seat (six-way adjustable):</p> <ul style="list-style-type: none"> • Reach • Backrest • Head restraint <p>Seat trim:</p> <ul style="list-style-type: none"> • Milano fabric seat trim inserts • Plain black fabric side bolsters 	●								
<p>Cloth front seats</p> <p>Ergonomic active driver's seat (16-way adjustable):</p> <ul style="list-style-type: none"> • Height • Reach • Tilt • Backrest • Lumbar adjustment (four-way electrical) • Head restraint (four-way) <p>Front passenger's seat (eight-way adjustable):</p> <ul style="list-style-type: none"> • Reach • Backrest • Head restraint (four-way) <p>Seat trim:</p> <ul style="list-style-type: none"> • Monita fabric seat trim inserts • Black Premium leather effect side bolsters 				●			●		
<p>Ergonomic active front seats (AGR-approved*)</p> <p>Driver's seat (18-way adjustable):</p> <ul style="list-style-type: none"> • Height • Reach • Tilt • Backrest • Seat cushion extension • Lumbar adjustment (four-way electrical) • Head restraint (four-way) <p>Front passenger's seat (eight-way adjustable):</p> <ul style="list-style-type: none"> • Reach • Backrest • Head restraint (four-way) <p>Please note: On Design models the driver's and front passenger's head restraints are only adjustable up and down.</p> <p>Seat trim:</p> <ul style="list-style-type: none"> • Monita fabric seat trim inserts • Black Premium leather effect side bolsters 		●	●						
<ul style="list-style-type: none"> • Milano fabric seat trim inserts • Plain black fabric side bolsters (Ergonomic active driver's seat) 	○							354.17	425.00

*AGR (The Campaign for Healthier Backs) is an independent centre of excellence for ergonomics, based in Germany.

● = Standard equipment. ○ = Optional at extra cost.

FEATURES/OPTIONS

SEATING AND COMFORT CONTINUED

	Design/ Design Nav	SRi/ SRi Nav	SRi VX-Line Nav	Tech Line Nav	Elite Nav	GSi Nav	Country Tourer	Price (£) exc. VAT	Price (£) inc. VAT
<p>Ergonomic active front seats (AGR-approved*)</p> <p>Driver's and front passenger's seat (18-way adjustable):</p> <ul style="list-style-type: none"> • Height • Reach • Tilt • Backrest • Seat cushion extension • Lumbar adjustment (four-way electrical) • Head restraint (four-way) • Heated front seats <p>Seat trim:</p> <ul style="list-style-type: none"> • Black Siena perforated leather seat trim inserts • Black Premium leather effect side bolsters 		○	○	○	●		○	962.50	1,155.00
<p>Premium ergonomic active front seats (AGR-approved*)</p> <p>Driver's and front passenger's seat (14-way adjustable):</p> <ul style="list-style-type: none"> • Height (electrical) • Reach (electrical) • Tilt (electrical) • Backrest (electrical) • Seat cushion extension • Lumbar adjustment (four-way electrical) • Massage functions • Active ventilation • Pneumatically adjustable backrest side bolsters • Driver's seat memory function, including door mirrors • Heated front seats • Heated outer rear seats • FlexFold 40/20/40 split-folding rear seat back <p>Seat trim:</p> <ul style="list-style-type: none"> • Black Siena perforated leather seat trim inserts • Black Premium leather effect side bolsters 						●			

*AGR (The Campaign for Healthier Backs) is an independent centre of excellence for ergonomics, based in Germany.

● = Standard equipment. ○ = Optional at extra cost.

FEATURES/OPTIONS

SEATING AND COMFORT CONTINUED

	Design/ Design Nav	SRI/ SRI Nav	SRI VX-Line Nav	Tech Line Nav	Elite Nav	GSI Nav	Country Tourer	Price (£) exc. VAT	Price (£) inc. VAT
<p>Power driver's seat (only available in conjunction with leather Ergonomic active front seats. Not available with optional Driving Assistance Pack Four)</p> <p>The following features are electrically adjustable:</p> <ul style="list-style-type: none"> • Height • Reach • Tilt • Backrest • Lumbar adjustment • Massage functions • Pneumatically adjustable backrest side bolsters • Driver's seat memory function, including door mirrors • Active ventilation for driver's and front passenger's seats • Electrically foldable door mirrors with puddle lights 		○	○	○	○		○	566.67	680.00
<p>Power driver's seat (only available on models with cloth trim. Not available with optional Driving Assistance Pack Four)</p> <p>The following features are electrically adjustable:</p> <ul style="list-style-type: none"> • Height • Reach • Tilt • Backrest • Lumbar adjustment • Massage functions • Pneumatically adjustable backrest side bolsters • Driver's seat memory function, including door mirrors • Heated front seats • Electrically foldable door mirrors with puddle lights 		○	○					425.00	510.00
• 60/40 split-folding rear seat back	●			●					
• FlexFold 40/20/40 split-folding rear seat back with one-touch release		●	●		●	●	●		
• Centre rear armrest		●	●		●	●	●		

● = Standard equipment. ○ = Optional at extra cost.

FEATURES/OPTIONS

INFOTAINMENT

	Design/ Design Nav	SRI/ SRI Nav	SRI VX-Line Nav	Tech Line Nav	Elite Nav	GSI Nav	Country Tourer	Price (£) exc. VAT	Price (£) inc. VAT
<p>Multimedia touchscreen infotainment system</p> <p>Onboard features:</p> <ul style="list-style-type: none"> • 7-inch colour touchscreen featuring tablet-like controls including swipe gestures • DAB digital radio/AM/FM stereo radio • RDS with Traffic Programme <p>Media connections:</p> <ul style="list-style-type: none"> • USB connection with iPod control in front centre armrest • Bluetooth® A2DP audio streaming (Advanced Audio Distribution Profile) <p>Mobile phone portal:</p> <ul style="list-style-type: none"> • Bluetooth® connectivity • Handsfree calls via steering wheel controls • Vehicle microphone • Phone book access – Contacts/last calls/missed calls etc. are mirrored on Multimedia display and are easily navigated using the touchscreen (features dependent on mobile phone). <p>Smartphone interface:</p> <ul style="list-style-type: none"> • Apple CarPlay™ • Android Auto™ 	●	●							
<p>Multimedia Navi touchscreen navigation and infotainment system</p> <p>Onboard features:</p> <ul style="list-style-type: none"> • 7-inch colour touchscreen • DAB digital radio/AM/FM stereo radio with 36 station presets • RDS with Traffic Programme <p>Navigation features:</p> <ul style="list-style-type: none"> • Satellite navigation system <p>Media connections:</p> <ul style="list-style-type: none"> • USB connection with iPod control • Bluetooth® A2DP audio streaming (Advanced Audio Distribution Profile) <p>Mobile phone portal:</p> <ul style="list-style-type: none"> • Bluetooth® connectivity • Handsfree calls via steering wheel controls • Vehicle microphone • Phone book access – Contacts/last calls/missed calls etc. are mirrored on display and are easily navigated using the touchscreen (features dependent on mobile phone). <p>Smartphone interface:</p> <ul style="list-style-type: none"> • Apple CarPlay™ • Android Auto™ <p>Traffic sign recognition:</p> <ul style="list-style-type: none"> • Recognises different road signs, including temporary speed restrictions • Displays reminder in the driver information centre 	▲	▲	●	●			●		

● = Standard equipment. ▲ = Standard on Nav models, see pricing page for details.

FEATURES/OPTIONS

INFOTAINMENT CONTINUED





	Design/ Design Nav	SRI/ SRI Nav	SRI VX-Line Nav	Tech Line Nav	Elite Nav	GSi Nav	Country Tourer	Price (£) exc. VAT	Price (£) inc. VAT
<p>Multimedia Navi Pro touchscreen navigation and infotainment Pack (standard on 1.6 (200PS) Automatic and Country Tourer 4X4 models)</p> <p>Onboard features:</p> <ul style="list-style-type: none"> • 8-inch colour touchscreen featuring tablet-like controls including swipe gestures • DAB digital radio/AM/FM stereo radio • RDS with Traffic Programme • 60 configurable favourites including contacts, addresses, playlists and radio stations • Voice control for audio, phone and navigation functions • Stores up to 5 user profiles for simple retrieval <p>Navigation features:</p> <ul style="list-style-type: none"> • Satellite navigation system • Integrated 3D European navigation with Traffic Message Channel TMC/TPEG • Connected navigation services¹ such as predictive navigation and live traffic alerts, parking information, online map updates, routing and POI search <p>Media connections:</p> <ul style="list-style-type: none"> • USB connection with iPod control in front centre armrest • Bluetooth® A2DP audio streaming (Advanced Audio Distribution Profile) <p>Mobile phone portal:</p> <ul style="list-style-type: none"> • Bluetooth® connectivity • Handsfree calls via steering wheel controls • Voice control support from connected phone • Phone book access – Contacts/last calls/missed calls etc. are mirrored on Multimedia display and are easily navigated using the touchscreen (features dependent on mobile phone). • SMS read out and reply <p>Instrumentation:</p> <ul style="list-style-type: none"> • 8-inch colour display incorporating speedometer and supplementary audio, phone and navigation information (standard on 1.6 (200PS) Automatic models) <p>Smartphone interface:</p> <ul style="list-style-type: none"> • Apple CarPlay™ • Android Auto™ <p>Traffic sign recognition:</p> <ul style="list-style-type: none"> • Recognises different road signs, including temporary speed restrictions • Displays reminder in the driver information centre and, where fitted, the optional head-up display 	○	○	○	○	●	●	○	966.67	1,160.00
Seven speakers (five front, two rear)	●	●	●	●	●		●		
<p>Bose® Premium Sound System (only available with Multimedia Navi Pro, standard on 2.0 (210PS) BiTurbo D 4X4 models. Not available in conjunction with optional emergency spare wheel)</p> <ul style="list-style-type: none"> • 4x45w channels • Bose® digital amplifier with six channels of customised equalisation • 7 premium speakers • Subwoofer 		○	○	○	○	●	○	583.33	700.00
Twin USB power sockets for rear seat passengers		●	●	●	●	●	●		
Wireless charger for mobile devices (Maximum device dimensions 75.7 x 23.6mm. Not suitable for Samsung Galaxy S8, S8 plus models)	○	○	○	○	○	○	○	133.33	160.00

¹Requires acceptance of Telenav end user licence agreement and consent to the use of personal data as set out in the Telenav privacy policy.

● = Standard equipment. ○ = Optional at extra cost.

FEATURES/OPTIONS

HEATING AND VENTILATION

	Design/ Design Nav	SRI/ SRI Nav	SRI VX-Line Nav	Tech Line Nav	Elite Nav	GSi Nav	Country Tourer	Price (£) exc. VAT	Price (£) inc. VAT
Air conditioning <ul style="list-style-type: none"> • Air recirculation facility • Cabin particulate filter – Removes dust, airborne particles and pollen. • Multi-speed fan • Illuminated controls • Rear floor heating ducts 	●								
Electronic climate control including air conditioning <ul style="list-style-type: none"> • Dual-zone control – Allowing different temperature settings for driver and front passenger. • Automatic front seat heating – On models ordered with Winter Pack or leather trim, front seat heating is switched on automatically to help achieve the requested interior temperature. • Advanced predictive logic control system using sun and humidity sensors • Partial air recirculation – Faster warm up/cool down. • Cabin particulate filter – Removes dust, airborne particles and pollen. • Automatic air direction and fan speed with manual override • LCD temperature display • Illuminated controls • Rear floor heating ducts 	○	●	●	●	●	●	●	337.50	405.00
Winter Pack One – models with cloth trim, without VX-Line Interior Pack  <ul style="list-style-type: none"> • Heated leather-covered steering wheel • Heated front seats – Three temperature settings. • Heated windscreen 		○		○			○	550.00	660.00
Winter Pack Two – models with leather trim, without VX-Line Interior Pack  <ul style="list-style-type: none"> • Heated leather-covered steering wheel • Heated windscreen 		○		○	○		○	333.33	400.00
Winter Pack Three – models with leather trim and VX-Line Interior Pack  <ul style="list-style-type: none"> • Heated windscreen 		○	○	○	○	○	○	125.00	150.00
Winter Pack Four – models with cloth trim and VX-Line Interior Pack  <ul style="list-style-type: none"> • Heated front seats – Three temperature settings. • Heated windscreen 		○	○	○			○	341.67	410.00

● = Standard equipment. ○ = Optional at extra cost.

FEATURES/OPTIONS

INTERIOR CONVENIENCE/LIGHTING

	Design/ Design Nav	SRI/ SRI Nav	SRI VX-Line Nav	Tech Line Nav	Elite Nav	GSI Nav	Country Tourer	Price (£) exc. VAT	Price (£) inc. VAT
Convenience features Automatically dimming anti-dazzle rear-view mirror – On Design models, fitted in conjunction with Sight and Light Pack. Not available separately.	☐	●	●	●	●	●	●		
Premium ambient lighting <ul style="list-style-type: none"> • Driver's and front passenger's LED illuminated vanity mirrors with flip-up covers • Ambient LED lighting in front doors and below audio unit 		●	●	●	●	●	●		
Interior storage <ul style="list-style-type: none"> • Storage pockets on front seat backs 		●	●	●	●		●		
Luggage compartment 12-volt electrical accessory socket (Sports Tourer/Country Tourer models)		●	●	●	●	●	●		
FlexOrganiser® Pack (Sports Tourer/Country Tourer models) <ul style="list-style-type: none"> • Four side rails • 3D storage net • Side net pocket • Four side rail hooks 	○	○	○	○	○	●	○	100.00	120.00

EXTERIOR LIGHTING

Standard lighting features <ul style="list-style-type: none"> • Automatic lighting control with tunnel detection – on Design models, fitted in conjunction with Sight and Light Pack. Not available separately. 	☐	●	●	●	●	●	●		
Front fog lights – also fitted as part of the Tech Line Nav Plus Pack.		●	●	○	●		●	141.67	170.00

● = Standard equipment. ○ = Optional at extra cost. ☐ = Available as part of an extra-cost option pack.

FEATURES/OPTIONS

EXTERIOR LIGHTING CONTINUED

	Design/ Design Nav	SRi/ SRi Nav	SRi VX-Line Nav	Tech Line Nav	Elite Nav	GSi Nav	Country Tourer	Price (£) exc. VAT	Price (£) inc. VAT
<p>IntelliLux LED® Matrix headlights</p> <p>IntelliLux LED® Matrix headlights work with the standard Driving Assistance Pack One incorporating front camera system, to provide outstanding lighting performance and enhanced safety. Each headlight features a matrix of 16 individual LED lights. These lights replace both the dipped beam and main beam functions. Each LED illuminates a separate part of the road ahead meaning that by automatically switching lights on and off, illumination is varied to suit traffic and road conditions.</p> <p>The IntelliLux system calculates which LED lights are activated and deactivated using additional data such as ambient light conditions, vehicle speed, steering angle and when the indicators are used. For example, when the front camera system detects an oncoming vehicle, the individual LED lights that would dazzle the oncoming driver are automatically switched off and then switched back on once the vehicle has passed. All other areas remain fully illuminated.</p> <hr/> <p>Every type of driving environment has been considered:</p> <ul style="list-style-type: none"> • Urban light – With street lighting and speeds up to 34mph, the system automatically enhances the dipped beam function. • Highway light – The system recognises when the car is on a dual carriageway or motorway. At higher speeds the light distribution on the right is reduced to minimise glare from the crash barriers whilst the left-side beam is lengthened. • Country light – As speeds increase, so does the lighting’s performance, illuminating the nearside of the road. • Static Cornering light – At lower speeds corners and bends are illuminated to match steering inputs. • Parking light – When reversing, additional side-facing lights are activated in the headlights. • Tourist mode – The lighting pattern can be adjusted when travelling abroad. • Energy saving mode – The IntelliLux LED® Matrix system goes into energy saving mode when the engine is automatically stopped. • Dipped beam, main beam and dynamic lighting: 32 electronically controlled LED lights (16 per headlight) • Intelligent main beam control • Automatic headlight levelling 		○	○	○	●	●	○	1,079.17	1,295.00
<p>Sight and Light Pack</p> <hr/> <ul style="list-style-type: none"> • Automatic lighting control with tunnel detection • Rain-sensitive windscreen wipers • Automatically dimming anti-dazzle rear-view mirror • High beam assist 	○	●	●	●	●	●	●	200.00	240.00

● = Standard equipment. ○ = Optional at extra cost.

FEATURES/OPTIONS

EXTERIOR CONVENIENCE

	Design/ Design Nav	SRI/ SRI Nav	SRI VX-Line Nav	Tech Line Nav	Elite Nav	GSI Nav	Country Tourer	Price (£) exc. VAT	Price (£) inc. VAT
Windscreen wipers • Rain-sensitive windscreen wipers – On Design models, fitted in conjunction with Sight and Light Pack. Not available separately.	☐	●	●	●	●	●	●		
• Intermittent rear window wash/wipe (Grand Sport models)	N/C	N/C	N/C	N/C	N/C	N/C		No-cost option	
Door mirrors • Electrically foldable door mirrors with puddle lights – Fitted as part of Driving Assistance Pack Three and Four and in conjunction with power driver's seat. Not available separately.	☐	☐	☐	☐	☐	●	☐		
Windows • Dark-tinted rear windows					●	●	●		
• Noise-reducing laminated side windows	○	○	○	○	○	○	○	183.33	220.00
Power tailgate (Sports Tourer/Country Tourer models) • Keyless entry with two transmitter fobs • Under-bumper release sensor • Tailgate close switch • Maximum opening height can be set to avoid damage in areas with low ceiling heights		○	○	○	○		○	566.67	680.00
Power tailgate (Sports Tourer models) • Under-bumper release sensor • Tailgate close switch • Maximum opening height can be set to avoid damage in areas with low ceiling heights						○		316.67	380.00
Roof rails (Sports Tourer/Country Tourer models) • Black	●								
• Silver-effect		●	●	●	●	●	●		
Towing Pack • Retractable tow bar • Trailer stability programme integrated into ESP system	○	○	○	○	○		○	570.83	685.00

● = Standard equipment. ○ = Optional at extra cost. ☐ = Available as part of an extra-cost option pack. N/C = No-cost option.







FEATURES/OPTIONS

EXTERIOR STYLING

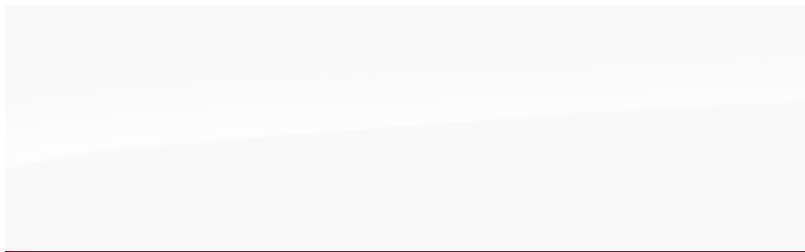
	Design/ Design Nav	SRI/ SRI Nav	SRI VX-Line Nav	Tech Line Nav	Elite Nav	GSI Nav	Country Tourer	Price (£) exc. VAT	Price (£) inc. VAT
Body styling		●	●						
• Rear spoiler (Grand Sport models)		●	●						
• Matt black B-pillars	●								
• Gloss black B-pillars		●	●	●	●	●	●		
• Matt black lower window trim	●	●	●						
• Gloss black lower window trim				●	●	●	●		
• GSi front and rear bumpers and side sills						●			
• GSi rear spoiler (Grand Sport models)						●			
• Dual visible exhaust tailpipes (Grand Sport 1.6 (200PS) Turbo and 2.0 (210PS) BiTurbo D models) – not available on 1.5 (165PS) Petrol, 1.6 (110/136PS) and 2.0 (170PS) Diesel Grand Sport Models)			●		●				
• Dual integrated exhaust tailpipes						●			
• Dual imitation exhaust bezels (Sports Tourer 1.6 (200PS) Turbo and 2.0 (210PS) BiTurbo D models – not available on 1.5 (165PS) Petrol, 1.6 (110/136PS) and 2.0 (170PS) Diesel Sports Tourer Models)		□	●	□	●		●		
• Anthracite wheel arch and side sill extensions							●		
• Front and rear bumpers incorporating silver-effect skid plates							●		
VX-Line Styling Pack (not available on 1.6 Turbo D (110PS) ecoTEC models or with Aegean Blue solid paint)		○	●	○	○			708.33	850.00
• Sports-style front and rear bumpers • Side sills • Rear spoiler (Grand Sport models) • Dual imitation exhaust bezels (Sports Tourer models) – not available on 1.5 (165PS) Petrol, 1.6 (110/136PS) and 2.0 (170PS) Diesel models)		○	●	○	○				
Tech Line Nav Plus Pack (not available on 1.6 diesel ecoTEC models)				○				416.67	500.00
• 18-inch technical grey diamond-cut alloy wheels • 245/45 R 18 tyres • Front fog lights				○					

● = Standard equipment. ○ = Optional at extra cost. □ = Available as part of an extra-cost option pack.

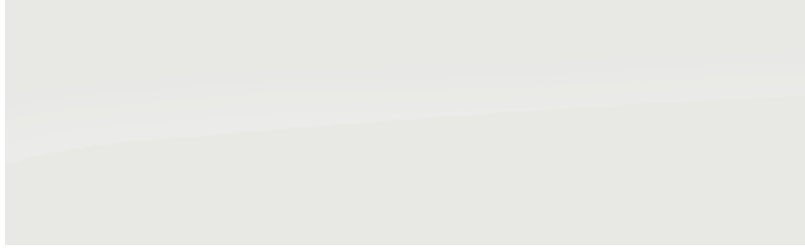
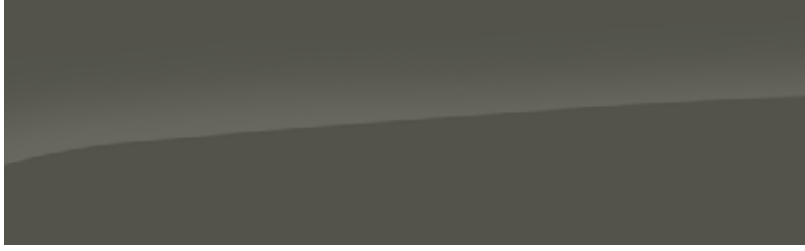

EXTERIOR COLOURS

				Design/ Design Nav	SRI/ SRI Nav	SRI VX-Line Nav	Tech Line Nav	Elite Nav	GSi Nav	Country Tourer	Price (£) exc. VAT	Price (£) inc. VAT		
Solid		Aegean Blue • Not available on Grand Sport SRI/SRI Nav models		●	●		●	●		●				
		Summit White • Standard colour on Grand Sport SRI/SRI Nav models		○	●	●	○	○	●	○	237.50	285.00		
Brilliant		Lava Red		○	○	○	○	○	○	○				
	Two-coat		Satin Steel Grey metallic • Not available on GSi Nav models		○	○	○	○	○	○	○	504.17	605.00	
		Sovereign Silver metallic												Mineral Black metallic
														Cosmic Grey metallic

The colours reproduced may vary slightly from the actual paint colour. As a result they should be used as a guide only. Your Vauxhall Retailer has a comprehensive display of our paint samples.

● = Standard equipment. ○ = Optional at extra cost.



EXTERIOR COLOURS

				Design/ Design Nav	SRi/ SRi Nav	SRi VX-Line Nav	Tech Line Nav	Elite Nav	GSi Nav	Country Tourer	Price (£) exc. VAT	Price (£) inc. VAT
Two-coat		Darkmoon Blue premium		Rioja Red premium	<input type="radio"/>	<input type="radio"/>	<input type="radio"/>	<input type="radio"/>	<input type="radio"/>	<input type="radio"/>	545.83	655.00
Tri-coat		Abalone White Premium			<input type="radio"/>	<input type="radio"/>	<input type="radio"/>	<input type="radio"/>	<input type="radio"/>	<input type="radio"/>	729.17	875.00

The colours reproduced may vary slightly from the actual paint colour. As a result they should be used as a guide only. Your Vauxhall Retailer has a comprehensive display of our paint samples.



○ = Optional at extra cost.

WHEELS AND TYRES

	Design/ Design Nav	SRI/ SRI Nav	SRI VX-Line Nav	Tech Line Nav	Elite Nav	GSi Nav	Country Tourer	Price (£) exc. VAT	Price (£) inc. VAT
Steel emergency spare wheel offer - 16-inch/17-inch									
1.5 (140PS) Turbo (Grand Sport/Sports Tourer 16-inch)	○							91.67	110.00
1.5 (165PS) Turbo/1.5 (165PS) Turbo auto (Grand Sport 16-inch/Sports Tourer 17-inch)	○	○	○	○	○				
1.6 (200PS) Turbo D auto (Grand Sport/Sports Tourer 17-inch)			○		○				
1.6 (110PS) Turbo D ecoTEC (Grand Sport/Sports Tourer 16-inch)	○	○		○	○				
1.6 (136PS) Turbo D (Grand Sport 16-inch/Sports Tourer 17-inch)	○	○	○	○	○				
1.6 (136PS) Turbo D auto (Grand Sport/Sports Tourer 16-inch)	○	○	○	○	○				
2.0 (170PS) Turbo D BlueInjection manual/auto (Grand Sport/Sports Tourer/Country Tourer 17-inch)	○	○	○	○	○		○		
2.0 (170PS) Turbo D 4X4 BlueInjection (Country Tourer 17-inch)							○		
 17-inch bi-colour structure wheels <ul style="list-style-type: none"> • 215/55 R 17 ultra-low rolling resistance tyres (1.6 diesel engines) • Emergency tyre inflation kit (in lieu of spare wheel) 	●								
 17-inch five twin-spoke alloy wheels <ul style="list-style-type: none"> • 215/55 R 17 ultra-low rolling resistance tyres (1.6 diesel engines) • 225/55 R 17 tyres (excluding 1.6 diesel engines) • Emergency tyre inflation kit (in lieu of spare wheel) 		●		●					
<ul style="list-style-type: none"> • All models excluding 1.6 diesel 	●								
<ul style="list-style-type: none"> • 1.6 diesel manual models only. Not available with other models 			●		●				



● = Standard equipment. ○ = Optional at extra cost.

WHEELS AND TYRES

	Design/ Design Nav	SRI/ SRI Nav	SRI VX-Line Nav	Tech Line Nav	Elite Nav	GSI Nav	Country Tourer	Price (£) exc. VAT	Price (£) inc. VAT
 <p>18-inch five-spoke alloy wheels</p> <ul style="list-style-type: none"> • 245/45 R 18 ultra-low rolling resistance tyres • Emergency tyre inflation kit (in lieu of spare wheel) • Not available on 1.6 diesel manual models 			●						
 <p>18-inch multi-spoke bi-colour technical grey diamond-cut alloy wheels</p> <ul style="list-style-type: none"> • 245/55 R 18 ultra-low rolling resistance tyres • Emergency tyre inflation kit (in lieu of spare wheel) • Not available on 1.6 diesel manual models • Available as part of Plus Pack on Tech Line Nav models 		○		○	●			420.83	505.00
 <p>18-inch five twin-spoke bi-colour technical grey alloy wheels</p> <ul style="list-style-type: none"> • 235/50 R 18 tyres • Emergency tyre inflation kit (in lieu of spare wheel) 							●		

● = Standard equipment. ○ = Optional at extra cost.

WHEELS AND TYRES

	Design/ Design Nav	SRi/ SRi Nav	SRi VX-Line Nav	Tech Line Nav	Elite Nav	GSi Nav	Country Tourer	Price (£) exc. VAT	Price (£) inc. VAT
 <p>20-inch five twin-spoke bi-colour high gloss black alloy wheels</p> <ul style="list-style-type: none"> • 245/35 R 20 tyres • Emergency tyre inflation kit (in lieu of spare wheel) • Only available as an option on 2.0 (170PS) Turbo D models 		○		○				829.17	995.00
			○		○			733.33	880.00
<ul style="list-style-type: none"> • Standard on 1.6 (200PS) Turbo and 2.0 (210PS) BiTurbo D models 			●		●				
 <p>20-inch bi-colour five twin-spoke alloy wheels</p> <ul style="list-style-type: none"> • 245/35 R 20 Michelin Pilot Sport 4S tyres • Emergency tyre inflation kit (in lieu of spare wheel) 						●			

● = Standard equipment. ○ = Optional at extra cost.

PERFORMANCE, FUEL ECONOMY AND EMISSIONS

GRAND SPORT	Performance (manufacturer's figures)			Fuel economy mpg (litres/100km)#		CO ₂ emissions g/km*	Vehicle Excise Duty**		Benefit in kind company car taxation rates - 2019/20 tax year
	Wheel size (inches)	Maximum speed (mph)	Acceleration 0-60mph (sec)	Combined Low	Combined High		First year rate	Standard rate	
Manual									
1.5 (140PS) Turbo	17/18	130	9.3	40.9 (6.9)	45.6 (6.2)	129	£170	£145	29%
1.5 (165PS) Turbo	17	138	8.4	40.4 (7.0)	44.8 (6.3)	129	£170	£145	29%
1.5 (165PS) Turbo (with ULRR tyres)	18	138	8.4	40.4 (7.0)	44.8 (6.3)	126	£170	£145	29%
1.6 (200PS) Turbo	20	146	7.2	39.2 (7.2)	42.2 (6.7)	145	£210	£145	33%
1.6 (110PS) Turbo D ecoTEC (with ULRR tyres)	17	127	11.1	54.3 (5.2)	57.7 (4.9)	116	£210	£145	31%
1.6 (136PS) Turbo D (with ULRR tyres)	17	131	9.9	49.6 (5.7)	54.3 (5.2)	121	£210	£145	32%
2.0 (170PS) Turbo D	17	140	8.2	47.1 (6.0)	51.4 (5.5)	141	£530	£145	37%
2.0 (170PS) Turbo D (with ULRR tyres)	18	140	8.2	47.1 (6.0)	51.4 (5.5)	138	£530	£145	37%
2.0 (170PS) Turbo D	20	140	8.2	47.1 (6.0)	51.4 (5.5)	144	£530	£145	37%
Automatic									
1.5 (165PS) Turbo	17	135	8.8	37.7 (7.5)	40.9 (6.9)	138	£210	£145	31%
1.5 (165PS) Turbo (with ULRR tyres)	18	135	8.8	37.7 (7.5)	40.9 (6.9)	135	£210	£145	31%
1.6 (200PS) Turbo	20	144	7.5	36.7 (7.7)	39.2 (7.2)	153	£530	£145	34%
1.6 (136PS) Turbo D (with ULRR tyres)	17/18	127	10.2	44.8 (6.3)	48.7 (5.8)	137	£530	£145	35%
2.0 (170PS) Turbo D	17	139	8.4	42.8 (6.6)	46.3 (6.1)	146	£530	£145	37%
2.0 (170PS) Turbo D (with ULRR tyres)	18	139	8.4	42.8 (6.6)	46.3 (6.1)	144	£530	£145	37%
2.0 (170PS) Turbo D	20	139	8.4	42.8 (6.6)	46.3 (6.1)	147	£530	£145	37%
2.0 (210PS) BiTurbo D 4X4 (exc. GSi Nav)	20	145	7.4	36.2 (7.8)	39.2 (7.2)	184	£1280	£145	37%
2.0 (210PS) BiTurbo D 4X4 GSi Nav	20	145	7.4	36.7 (7.7)	37.2 (7.6)	187	£1280	£145	37%

ULRR = Ultra-low rolling resistance.

#Fuel consumption figures are determined according to the WLTP test cycle. Full data relating to WLTP test cycles can be found at: www.vauxhall.co.uk/wltp

*CO₂ emissions figures are determined according to the WLTP test cycle however, a Government formula is then applied to translate these figures back to what they would have been under the outgoing NEDC test cycle, which WLTP replaces. The correct tax treatment is then applied.

Figures are intended for comparability purposes only. The fuel consumption you achieve under real life driving conditions and CO₂ produced will depend upon a number of factors, including the accessories fitted after registration, variations in driving styles, weather conditions and vehicle load. Only compare fuel consumption and CO₂ with other vehicles tested using the same technical procedures. For more information contact your local Vauxhall Retailer.

**Correct at time of publication.

PERFORMANCE, FUEL ECONOMY AND EMISSIONS

SPORTS TOURER	Performance (manufacturer's figures)			Fuel economy mpg (litres/100km)#		CO ₂ emissions g/km*	Vehicle Excise Duty**		Benefit in kind company car taxation rates - 2019/20 tax year
	Wheel size (inches)	Maximum speed (mph)	Acceleration 0-60mph (sec)	Combined Low	Combined High		First year rate	Standard rate	
Manual									
1.5 (140PS) Turbo	17/18	129	9.6	39.2 (7.2)	43.5 (6.5)	131	£210	£145	30%
1.5 (165PS) Turbo	17	135	8.6	39.2 (7.2)	43.5 (6.5)	131	£210	£145	30%
1.5 (165PS) Turbo (with ULRR tyres)	18	135	8.6	39.2 (7.2)	43.5 (6.5)	128	£210	£145	30%
1.6 (200PS) Turbo	20	144	7.4	38.2 (7.4)	41.5 (6.8)	151	£515	£145	34%
1.6 (110PS) Turbo D ecoTEC (with ULRR tyres)	17	126	10.9	52.3 (5.4)	55.4 (5.1)	121	£210	£145	32%
1.6 (136PS) Turbo D (with ULRR tyres)	17	129	10.1	47.9 (5.9)	52.3 (5.4)	125	£210	£145	33%
2.0 (170PS) Turbo D	17	139	8.4	45.6 (6.2)	50.4 (5.6)	145	£530	£145	37%
2.0 (170PS) Turbo D (with ULRR tyres)	18	139	8.4	45.6 (6.2)	50.4 (5.6)	142	£530	£145	37%
2.0 (170PS) Turbo D	20	139	8.4	45.6 (6.2)	50.4 (5.6)	148	£530	£145	37%
Automatic									
1.5 (165PS) Turbo	17	133	9.0	36.2 (7.8)	39.8 (7.1)	144	£210	£145	32%
1.5 (165PS) Turbo (with ULRR tyres)	18	133	9.0	36.2 (7.8)	39.8 (7.1)	140	£210	£145	32%
1.6 (200PS) Turbo	20	143	7.7	35.8 (7.9)	38.7 (7.3)	154	£515	£145	34%
1.6 (136PS) Turbo D (with ULRR tyres)	17/18	126	10.5	44.1 (6.4)	47.9 (5.9)	139	£530	£145	35%
2.0 (170PS) Turbo D	17	137	8.6	41.5 (6.8)	45.6 (6.2)	148	£530	£145	37%
2.0 (170PS) Turbo D (with ULRR tyres)	18	137	8.6	41.5 (6.8)	45.6 (6.2)	147	£530	£145	37%
2.0 (170PS) Turbo D	20	137	8.6	41.5 (6.8)	45.6 (6.2)	150	£530	£145	37%
2.0 (210PS) BiTurbo D 4X4 (exc. GSi Nav)	20	144	7.5	35.8 (7.9)	38.7 (7.3)	187	£1280	£145	37%
2.0 (210PS) BiTurbo D 4X4 GSi Nav	20	144	7.5	35.3 (8.0)	36.7 (7.7)	188	£1280	£145	37%

ULRR = Ultra-low rolling resistance.

#Fuel consumption figures are determined according to the WLTP test cycle. Full data relating to WLTP test cycles can be found at: www.vauxhall.co.uk/wltp

*CO₂ emissions figures are determined according to the WLTP test cycle however, a Government formula is then applied to translate these figures back to what they would have been under the outgoing NEDC test cycle, which WLTP replaces. The correct tax treatment is then applied.

Figures are intended for comparability purposes only. The fuel consumption you achieve under real life driving conditions and CO₂ produced will depend upon a number of factors, including the accessories fitted after registration, variations in driving styles, weather conditions and vehicle load. Only compare fuel consumption and CO₂ with other vehicles tested using the same technical procedures. For more information contact your local Vauxhall Retailer.

**Correct at time of publication.

PERFORMANCE, FUEL ECONOMY AND EMISSIONS

COUNTRY TOURER	Performance (manufacturer's figures)			Fuel economy mpg (litres/100km)#		CO ₂ emissions g/km*	Vehicle Excise Duty**		Benefit in kind company car taxation rates - 2019/20 tax year
	Wheel size (inches)	Maximum speed (mph)	Acceleration 0-60mph (sec)	Combined Low	Combined High		First year rate	Standard rate	
Manual									
2.0 (170PS) Turbo D	18	137	8.6	44.8 (6.3)	47.1 (6.0)	150	£530	£145	37%
2.0 (170PS) Turbo D 4X4	18	135	9.3	40.9 (6.9)	42.2 (6.7)	164	£855	£145	37%
Automatic									
2.0 (170PS) Turbo D	18	135	8.8	41.5 (6.8)	43.5 (6.5)	151	£855	£145	37%
2.0 (210PS) BiTurbo D 4X4	18	142	7.7	35.3 (8.0)	36.7 (7.7)	188	£1280	£145	37%

#Fuel consumption figures are determined according to the WLTP test cycle. Full data relating to WLTP test cycles can be found at: www.vauxhall.co.uk/wltp

*CO₂ emissions figures are determined according to the WLTP test cycle however, a Government formula is then applied to translate these figures back to what they would have been under the outgoing NEDC test cycle, which WLTP replaces. The correct tax treatment is then applied.

Figures are intended for comparability purposes only. The fuel consumption you achieve under real life driving conditions and CO₂ produced will depend upon a number of factors, including the accessories fitted after registration, variations in driving styles, weather conditions and vehicle load. Only compare fuel consumption and CO₂ with other vehicles tested using the same technical procedures. For more information contact your local Vauxhall Retailer.

**Correct at time of publication.

DIMENSIONS

Loadspace Dimensions	Grand Sport	Sports Tourer
Load floor length (rear seats folded)	1940 (76.4)	2005 (78.9)
Load floor length (behind rear seats)	1133 (44.6)	1178 (46.3)
Load area width	1030 (40.5)	1030 (40.5)
Load area height	722 (28.4)	794 (31.2)
Tailgate aperture height	557 (21.9)	711 (28.0)
Luggage Capacities* litres (cu.ft.)		
Rear seat up (under luggage compartment cover)	490 (17.3)	560 (19.8)
Rear seat down (measured to roof)	1450 (51.1)	1665 (58.8)

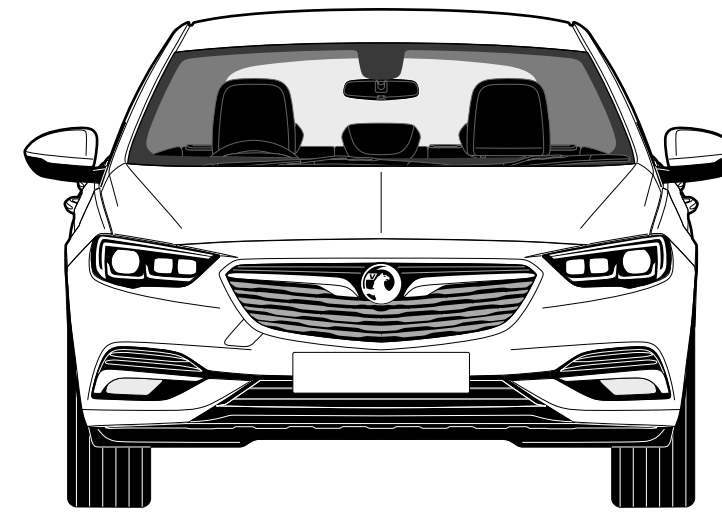

1863 (73.3)
excluding door mirrors
2093 (82.4)
including door mirrors

1455
(57.3)

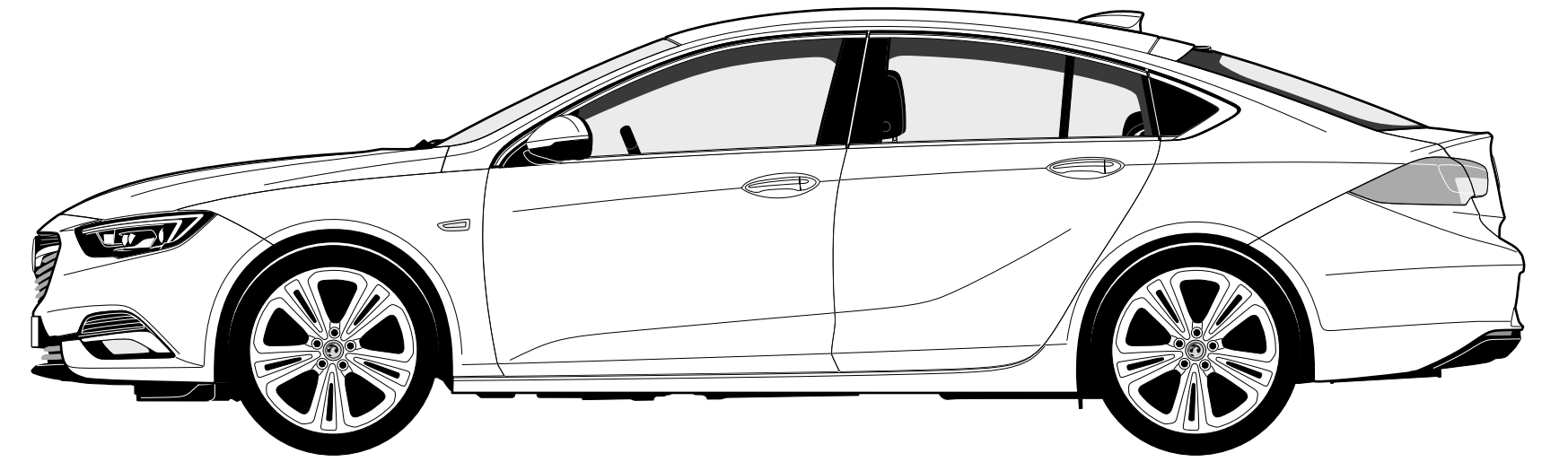

990 (39.0) 2829 (111.4) 1078 (42.4)
4897 (192.8)

GRAND SPORT



1863 (73.3)
excluding door mirrors
2093 (82.4)
including door mirrors

1514
(59.6)

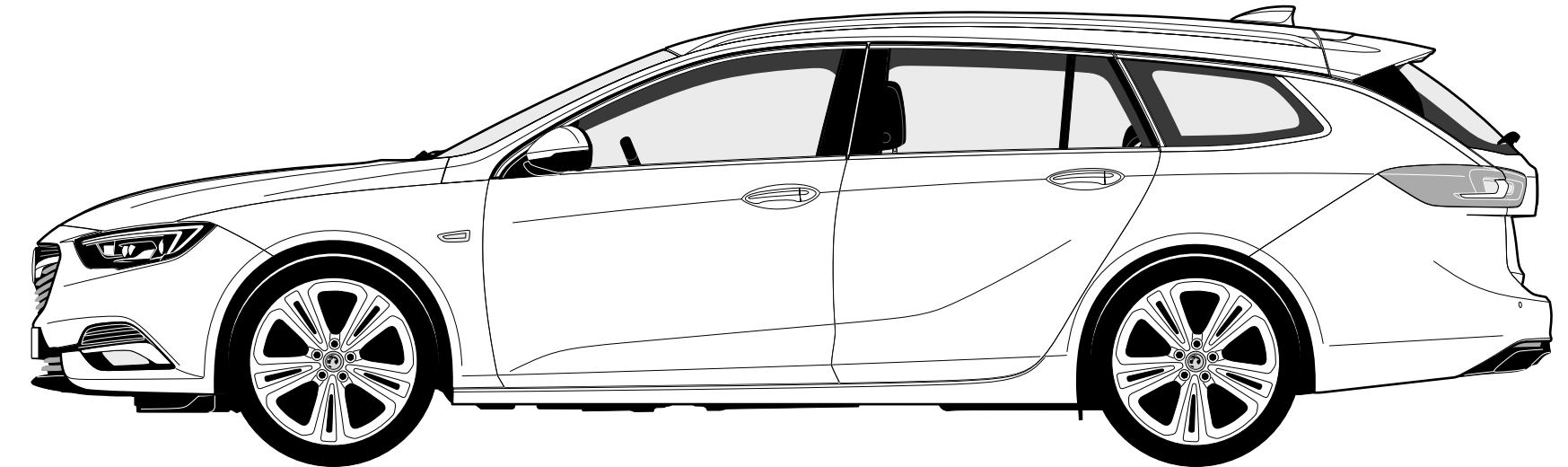

990 (39.0) 2829 (111.4) 1167 (46.0)
4986 (196.3)

SPORTS TOURER



1863 (73.3)
excluding door mirrors
2093 (82.4)
including door mirrors

1534
(60.4)

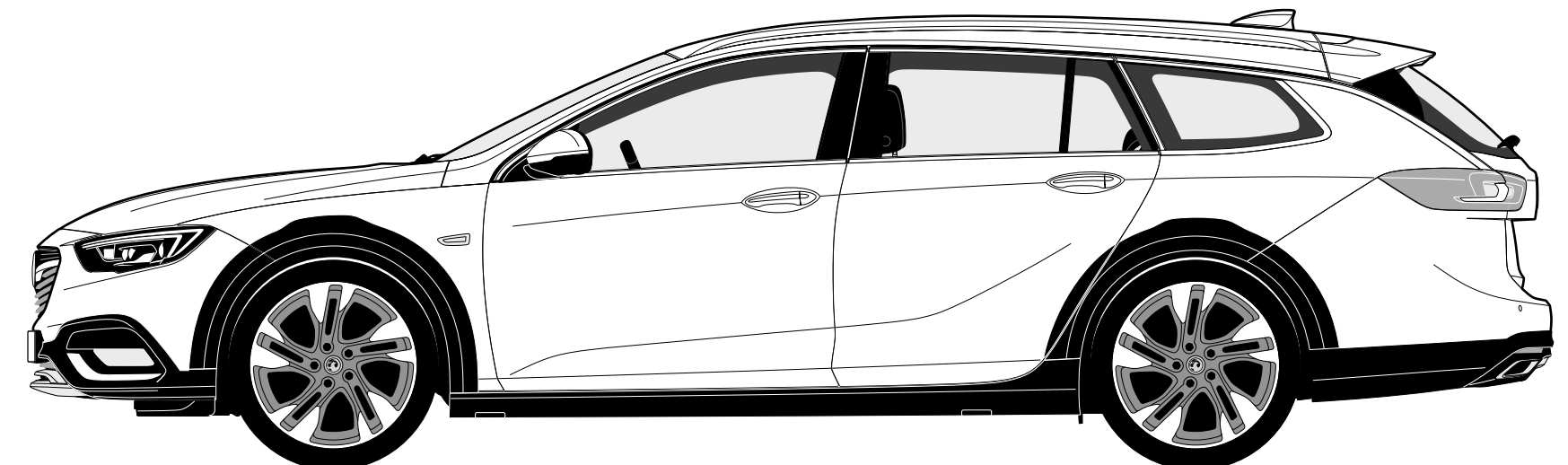

990 (39.0) 2829 (111.4) 1167 (46.0)
4986 (196.3)

COUNTRY TOURER

All measurements are in mm (inches) unless stated otherwise.

*Measured using the ECIE method. When an optional spare wheel is specified loadspace capacity is reduced due to a raised luggage compartment floor.

SPECIFICATIONS

Weights and Towing Data kg

	Gross vehicle weight			Maximum towing weights Trailer with brakes (without brakes)		
	Grand Sport	Sports Tourer	Country Tourer	Grand Sport	Sports Tourer	Country Tourer
1.5 (140PS) Turbo	2015	2080	-	1405 (700)	1405 (730)	-
1.5 (165PS) Turbo	2015	2085	-	1405 (700)	1405 (730)	-
1.5 (165PS) Turbo automatic	2040	2110	-	1405 (700)	1405 (730)	-
1.6 (200PS) Turbo	2090	2130	-	1410 (730)	1410 (750)	-
1.6 (200PS) Turbo automatic	2110	2165	-	1410 (730)	1410 (750)	-
1.6 (110PS) Turbo D ecoTEC	2035	2125	-	1405 (720)	1405 (750)	-
1.6 (136PS) Turbo D	2070	2140	-	1405 (730)	1405 (750)	-
1.6 (136PS) Turbo D automatic (inc. Sports Tourer)	2095	2165	-	1300 (730)	1300 (750)	-
2.0 (170PS) Turbo D	2185	2240	2240	1950 (750)	1950 (750)	1950 (750)
2.0 (170PS) Turbo D automatic	2220	2270	2270	1700 (750)	1700 (750)	1700 (750)
2.0 (170PS) Turbo D 4X4	-	-	2330	-	-	2200 (750)
2.0 (210PS) BiTurbo D 4X4	2340	2390	2380	1805 (750)	1805 (750)	1805 (750)

Gross vehicle weight is the total permissible weight of the vehicle including passengers and their luggage. **The maximum roof rack loading** should not exceed 100kg on all models. **The maximum towing weights** are based on the ability of the car, with two occupants of 75kg each, to restart on a 12% gradient, which is approximately 1 in 8.3, at sea level. The permitted trailer load applies up to the specified incline and up to an altitude of 1000 metres above sea level. The permissible gross train weight decreases by 10% for every 1000 metres of additional altitude. Any extra weight, such as luggage or additional passengers, should be deducted from the maximum towing weight. With a trailer fully loaded, maximum noseweight should not exceed 60kg (75kg on Sports Tourer models, 90kg on 2.0 (170PS) Turbo D and 2.0 (210PS) BiTurbo 4x4 models). Always fit Vauxhall towing attachments and accessories available from your Vauxhall Retailer. They are designed specifically for Vauxhall models and carry a 12-month guarantee. During trailer towing do not exceed a maximum speed of 60mph. This speed limit is also applicable in countries with higher permitted speeds for trailer-vehicle combinations. Pay attention to the local speed limits. For trailers with low driving stability and caravans the use of an oscillation damper is strongly recommended.

SPECIFICATIONS

Transmission

Six-speed manual gearbox

Petrol engines: 1.5 (140PS) Turbo, 1.5 (165PS)

Turbo and 1.6 (200PS) Turbo models

Diesel engines: 1.6 (110/136PS) Turbo D and

2.0 (170PS) Turbo D models

Automatic transmission with ActiveSelect®

Six-speed automatic transmission: Optional at extra cost on 1.5 (165PS) Turbo/1.6 (200PS) Turbo/1.6 (136PS) Turbo D models.

Eight-speed automatic transmission: Standard on 2.0 (210PS) BiTurbo D 4X4, optional at extra cost on 2.0 (170PS) Turbo D front-wheel drive models.

The latest generation automatic transmissions available on Insignia, incorporating Start/Stop technology, offer improved fuel economy and refinement over previous versions. On the road, a wide selection of shift patterns is adapted to the style and habits of the driver, anticipating when maximum acceleration or maximum efficiency is required. The electronic control will also adapt to the prevailing road conditions, reducing gear shifting when climbing or descending and using engine braking assistance during down changes.

The ActiveSelect® manual mode allows the gear lever to be used like a sequential manual gearbox – you simply push the lever forward or back to change up or down the gears. The eight-speed transmission includes a range of driver-selectable modes.

Four-wheel drive system

Standard on Elite Nav 2.0 (210PS) BiTurbo D 4X4, GSi Nav and Country Tourer 4X4 models. The sophisticated four-wheel drive system replaces the conventional rear axle differential with two electronically controlled clutches which allows Insignia to take advantage of the latest torque vectoring technology. This ensures that torque is directed to the wheels with the greatest grip, thus improving handling in all conditions and traction in slippery conditions.

Braking and stability

- Electronic Stability Programme (ESP)
- Cornering brake control
- Straight line stability control
- Rollover mitigation
- Drag torque control
- Hill start assist
- Anti-lock Braking System (ABS)
- Emergency brake assist
- Fading brake support
- Electronic brakeforce distribution
- Adaptive brake lights

1.5 (140PS/165PS) Turbo

Front ventilated discs: 300mm diameter

Rear discs: 288mm diameter

1.6 (110PS) Turbo D

Front ventilated discs: 300mm diameter

Rear discs: 288mm diameter

1.6 (136PS) Turbo D

Front ventilated discs: 321mm diameter

Rear discs: 288mm diameter

1.6 (200PS) Turbo

Front ventilated discs: 300mm diameter

Rear discs: 288mm diameter

2.0 (170PS) Turbo D

Front ventilated discs: 321mm diameter

Rear ventilated discs: 315mm diameter

2.0 (170PS) Turbo D 4X4

Front ventilated discs: 321mm diameter

Rear ventilated discs: 315mm diameter

2.0 (210PS) BiTurbo D 4X4 (excluding GSi Nav)

Front ventilated discs: 321mm diameter

Rear ventilated discs: 315mm diameter

2.0 (210PS) BiTurbo D 4X4 GSi Nav

Front ventilated discs: 345mm diameter

Rear ventilated discs: 315mm diameter

Suspension

Front: Independent. Lightweight MacPherson struts with gas-pressure dampers and coil springs. Anti-roll bar.

Rear: Lightweight multi-link (FWD - 4-link; 4X4 - 5-link) with rising-rate mini-block coil springs and gas-pressure dampers. Anti-roll bar.

- GSi Nav models feature an updated sports chassis with lower ride height and specially tuned dampers

FlexRide (Adaptive Stability Technology) system

FlexRide offers drivers the choice of three distinct driving modes – Normal (default setting), Sport or Tour. GSi Nav models include a fourth, unique, Competition mode.

- **Sport mode:** This stiffens the car's suspension and sharpens steering and throttle responses. It also raises the threshold at which the ESP and traction control systems are activated, enhancing dynamic performance
- **Tour mode:** Ideal for long motorway journeys, the Tour mode adjusts the dampers to a softer setting to create a perceptibly smoother ride and further enhance Insignia's ride comfort
- **Continuous damping control:** Utilises data from up to 11 variables including acceleration, braking and cornering to constantly control the suspension for optimum stability, driver engagement and comfort. Operates in all three driving modes

Body

Aerodynamic drag co-efficient:

Cd 0.26

Steering

- Speed-sensitive electric power-assisted steering
- Turning circle (kerb-to kerb):
– 11.15m (36.6ft.)

Fuel Tank Capacity

62 litres (13.6 gallons)

Adblue Tank Capacity

15 litres (3.3 gallons)

PETROL ENGINES

Engine	1.5 (140PS) Turbo with Start/Stop	1.5 (165PS) Turbo with Start/Stop	1.6 Turbo (200PS) with Start/Stop
Capacity	1490cc	1490cc	1598cc
Maximum power	140PS (103kW) @ 5600rpm	165PS (121kW) @ 5600rpm	200PS (147kW) @ 4700-5500rpm
Maximum torque	250Nm (184 lb.ft.) @ 2000-4100rpm	250Nm (184 lb.ft.) @ 2000-4500rpm	300Nm (221 lb.ft.) @ 1700-4700rpm
Configuration	4 cylinders, 4 valves per cylinder, double overhead camshafts	4 cylinders, 4 valves per cylinder, double overhead camshafts	4 cylinders, 4 valves per cylinder, double overhead camshafts
Fuel/induction system	Turbocharger with intercooler. Variable Valve Timing (VVT). Direct fuel injection	Turbocharger with intercooler. Variable Valve Timing (VVT), Direct fuel injection	Water-cooled turbocharger with intercooler. Variable Valve Timing (VVT). Central direct fuel injection
Emission compliance	Euro 6d-TEMP (6.2). Gasoline Particulate Filter	Euro 6d-TEMP (6.2). Gasoline Particulate Filter	Euro 6d-TEMP (6.2). Gasoline Particulate Filter
Service interval	20,000 miles or 1 year (whichever occurs sooner)	20,000 miles or 1 year (whichever occurs sooner)	20,000 miles or 1 year (whichever occurs sooner)

DIESEL ENGINES

Engine	1.6 (110PS) Turbo D ecoTEC with Start/Stop	1.6 (136PS) Turbo D with Start/Stop	2.0 (170PS) Turbo D with Start/Stop
Capacity	1598cc	1598cc	1956cc
Maximum power	110PS (81kW) @ 4000rpm	136PS (100kW) @ 3500-4000rpm	170PS (125kW) @ 3750rpm
Maximum torque	300Nm (221 lb.ft.) @ 2000rpm	320Nm (236 lb.ft.) @ 2000-2250rpm	400Nm (295 lb.ft.) @ 1750-2500rpm
Configuration	4 cylinders, 4 valves per cylinder, double overhead camshafts	4 cylinders, 4 valves per cylinder, double overhead camshafts	4 cylinders, 4 valves per cylinder, double overhead camshafts
Fuel/induction system	Turbocharger with intercooler. Common rail fuel injection	Variable geometry turbocharger with intercooler. Common rail fuel injection	Variable geometry turbocharger with intercooler. Common rail fuel injection
Emission compliance	Euro 6d-TEMP (6.2). Diesel Particulate Filter	Euro 6d-TEMP (6.2). Diesel Particulate Filter	Euro 6d-TEMP (6.2). Diesel Particulate Filter
Service interval	20,000 miles or 1 year (whichever occurs sooner)	20,000 miles or 1 year (whichever occurs sooner)	20,000 miles or 1 year (whichever occurs sooner)

Engine	2.0 (210PS) BiTurbo D with Start/Stop
Capacity	1956cc
Maximum power	210PS (154kW) @ 4000rpm
Maximum torque	480Nm (354 lb.ft.) @ 1500rpm
Configuration	4 cylinders, 4 valves per cylinder, double overhead camshafts
Fuel/induction system	Two stage turbocharger with intercooler. Common rail fuel injection
Emission compliance	Euro 6d-TEMP (6.2). Diesel Particulate Filter
Service interval	20,000 miles or 1 year (whichever occurs sooner)

ACCESSORIES

CHILD SEATS¹ Total (inc. VAT)

BABY-SAFE ² – 0-13kg/birth to 15 months	£141
– ISOFIX base	£244
DUO ISOFIX ² – 9-18kg/9 months to 4 years	
with top tether kit	£372
KID ² – 15-36kg or 4 to 12 years	£168

INTERIOR

Cupholder insert	
– Tissue	£17
– Notepad	£17
– Make-up	£17

SAFETY

Parking sensors	
– four fully flush front bumper mounted sensors	£317
– four fully flush rear bumper mounted sensors	£336
Rear view camera	£275
Safety Pack – first aid kit, hi-visibility vest and small warning triangle	£30
Warning triangle – Small	£12
Warning triangle – Large	£20
First aid kit	£15
Hi-visibility vest	£9

FLEXCONNECT RANGE Total (inc. VAT)

FlexConnect bracket	£22
FlexConnect hook	£32
FlexConnect coat hanger	£34
FlexConnect folding table	£77
FlexConnect iPad Mini cradle	£109
FlexConnect iPad (1-4) cradle	£118
FlexConnect iPad Air cradle	£117
FlexConnect Samsung Galaxy cradle	£107

PRACTICAL

Spare bulb kit ³	£39
Spare bulb kit (white) ³	£38
Stretch tow rope – 3000kg	£36
Privacy Shades (rear and rear side windows)	
– Grand Sport	£94
– Sports Tourer	£108

PROTECTION

Rubber floor mats – set of four	£51
Velour floor mats – set of four	£55
Economy floor mats – set of four	£45
Cargo liner – reversible	£92
Cargo net - horizontal	
– Grand Sport	£46
– Sports Tourer	£51
Mudflaps	
– front	£51
– rear (Grand Sport)	£51
– rear (Sports Tourer) ⁴	£46
Dog guard (Sports Tourer)	£193
Door mirror caps	
– Carbon	£134
– Aluminium	£229
Bumper load protection film	£98

TRANSPORT SYSTEMS Total (inc. VAT)

Roof base carrier	from £180
Roof carriers (requires base carrier)	
Bike roof carrier – Thule Freeride 532	£78
Surf board roof carrier – Thule 833	£82
Kayak roof carrier – Thule 837	£172
Ski roof carrier – up to 4 pairs (400mm wide) – Thule 7324	£161
Ski roof carrier – up to 6 pairs (600mm wide) – Thule 7326	£190
Hard shell roof boxes (requires base carrier)	
Thule Ocean 80 (320 litre/1330 x 860 x 370mm)	£154
Thule Ocean 200 (450 litre/1750 x 820 x 450mm)	£323
Thule Motion 800 (460 litre/2050 x 840 x 450mm)	from £463
Thule Touring 200 (400 litre/1750 x 820 x 450mm)	£338
Thule Touring 700 (430 litre/2320 x 700 x 420mm)	£384
Tow bar carrier system	
Fixed tow bar	£472
Detachable tow bar	£564

STYLING Total (inc. VAT)

Door sill plates	£40
Stainless steel pedal covers	
– manual	£127
– automatic	£150
Rear Spoiler (Grand Sport)	£266

ALLOY WHEELS (set of four with centre caps)⁵

18-inch High Gloss Black	£1,306
--------------------------	--------

Please note: Prices shown are fully fitted and painted, where applicable and include VAT. Please check with your local Vauxhall Retailer for details. It is advisable to ensure your insurance policy is adequate to cover additional fitted accessories. Prices correct at time of publication.

¹Restrictions apply to the use of child seats, please consult your Vauxhall Retailer or request a copy of the Child seats brochure. ²Without transponder. ³Excludes xenon headlight bulb for models with Adaptive Forward Lighting (AFL). ⁴Excludes Country Tourer. ⁵Different tyres and locking wheel bolts/nuts may be required at extra cost. Price excludes new tyres and locking wheel bolts/nuts, includes static wheel balancing.

COMPANY CAR DRIVER AND FLEET INFORMATION

Design and Tech Line High Spec Low P11D

Specifically developed for businesses and company car drivers alike, our Design and Tech Line Nav models are seriously fit for Fleet.

Design models all feature very low P11D values, generous standard specification, including Sat Nav on Design Nav models, and a choice of high tech ecoTEC engines for great fuel economy and low emissions.

For even more standard specification, step up to our Tech Line Nav range. Again you are guaranteed low P11D values, plus great standard kit including Sat Nav, Bluetooth®, USB connection, aux-in socket and digital radio.

With Design and Tech Line Nav you can take for granted low Whole Life Costs and low company car driver taxation.

Company Car Driver Free 3 Day Test Drive

Our free* 3 Day Test Drive programme is open to all Company Car Drivers which allows you to choose any model in the current Vauxhall line-up (exclusions apply). With full insurance cover provided, it gives you a meaningful length of time to make an informed decision about your next company car.

Search Vauxhall 3DTD to book your FREE* test drive or click the link the below:

[Vauxhall 3 Day Test Drive](#)

*The free 3 Day Test Drive programme is open to Company Car Drivers and Fleet Decision Makers. Available for UK Mainland only. Terms and conditions apply. Full terms and conditions can be found at vauxhallfleet.co.uk/testdrive/index/terms.

Benefit in kind company car taxation†

The car benefit charge will be the car's list price (including VAT, options and accessories fitted, delivery to Retailer and number plates, but excluding Vehicle Excise Duty and new vehicle first registration fee) multiplied by the percentage charge for the CO₂ emissions band in which the car falls (see table opposite). Multiply this figure by your personal income tax rate (20%^{††} for Basic Rate, 40%^{††} for Higher Rate) to calculate your annual benefit in kind tax liability.

Example:

Insignia Tech Line Nav 1.6 (110PS) Turbo D ecoTEC Grand Sport (CO ₂ emissions 116g/km)	
On-the-road RRP	£23,405.00
Deduct: Vehicle Excise Duty	(£210.00)
New vehicle first registration fee	(£55.00)
Effective list price	£23,140.00
Add: Optional two-coat metallic paint	£605.00
List price for tax purposes (P11D value)	£23,745.00
Car benefit charge 2019-20 tax year (31%)	£7,361.00
Benefit in kind tax liability (2019-20 tax year)	
Basic Rate (20%) tax payer	£1,472.20
Higher Rate (40%) tax payer	£2,944.40

†Please note this Price Guide provides taxation information as a guide only. Vauxhall does not provide taxation guidance. Drivers should always take professional advice on their own tax position.

††Excludes residents of Scotland.

BIK FOR SCOTTISH RESIDENTS

Effective 6 April 2018 the Scottish Government have introduced their own BIK taxation structure. This only applies to Company Car Drivers that are Scottish taxpayers. HMRC will determine whether or not an individual is a Scottish taxpayer based on where their main place of residence is.

The BIK rates for Scotland are:

- Over £12,500-£14,549 Starter Rate 19%
- Over £14,549-£24,994 Basic Rate 20%
- Over £24,994-£43,430 Intermediate Rate 21%
- Over £43,430-£150,000 Higher Rate 41%
- Above £150,000 Top Rate 46%

Benefit in kind company car taxation table

CO ₂ emissions in grams per kilometre	Percentage of cars price to be taxed	
	Non-Diesel [‡] 2019-20 tax year	Diesel ^{‡‡} 2019-20 tax year
Up to 50	16	20
51-75	19	23
76-94	22	26
95-99	23	27
100-104	24	28
105-109	25	29
110-114	26	30
115-119	27	31
120-124	28	32
125-129	29	33
130-134	30	34
135-139	31	35
140-144	32	36
145-149	33	37
150-154	34	37
155-159	35	37
160-164	36	37
165-169	37	37
170-174	37	37
175-179	37	37
180 and above	37	37

[‡]Also applies to diesel vehicles that meet the Real Driving Emissions Step 2 (RDE2). ^{‡‡}Applies to vehicles that do not meet the Real Driving Emissions Step 2 (RDE2).

To calculate your own personal liability, search: **Vauxhall BiK**, or click the link below: [Vauxhall BiK Tool](#)

Fleet Toolbox

Discover the facts in our online Toolbox for both Company Car Drivers and Fleet Decision Makers. The Fleet Toolbox has a host of useful calculators, comparators, interactive listings and information.

Search Vauxhall Fleet Tools or click the link below: [Vauxhall Fleet Tool Box](#)

Contact Vauxhall Fleet

Please contact one of our dedicated sales teams who will be happy to help with your particular enquiry.

Company Car Drivers

Call: 0345 111 2020

Email: company-car@vauxhallinfo.co.uk

Telephone lines are open

- Monday to Friday 8:00am-9:00pm

- Saturday and Sunday 9:00am-6:00pm

Fleet Decision Makers

Depending on the size of your fleet of vehicles, we have a dedicated team to handle your enquiries. The lines are open Monday to Friday excluding Bank Holidays.

1-24 vehicles

Call: 0845 076 2254 (8:30am-5:00pm)

25+ vehicles

Call: 0330 587 8222 (8:30am-5:00pm)

Email: vauxhallfleet@vauxhall.co.uk

Special Vehicles (Police, Fire and Ambulance)

Call: 01582 409999 (8:30am-5:00pm)

Email: vauxhallspecialvehicles@vauxhall.co.uk

For more information visit www.vauxhall.co.uk/fleet

FURTHER INFORMATION

On-the-road prices

To eliminate uncertainty about hidden costs when buying a new car, Vauxhall publishes on-the-road recommended retail prices (RRP) and these are shown in the pricing tables within this price guide. These prices include VAT, number plates and delivery to Retailer of £700.00 (including £116.67 VAT), 12 months' Government Vehicle Excise Duty (see opposite for details) and the DVLA new vehicle first registration fee of £55.00.*

Please note: The on-the-road recommended retail price (RRP) does not include fuel supplied by the Retailer, motor insurance or any other goods or services supplied by agreement between the Retailer and the customer.

Price protection

Order a new Vauxhall for build in the current model year (as confirmed by your Retailer) for delivery no more than three months in advance and the price you are quoted is the price you pay. This is irrespective of any subsequent price rises between placing your order and delivery of your new car, but you must take delivery as soon as the car is available. Vauxhall Motors Limited is not liable for price adjustments caused by Government changes in the rate of VAT (currently 20%), Vehicle Excise Duty, DVLA new vehicle first registration fee or by any other applicable legislation or regulations.

Vauxhall Finance Leasing

Vauxhall Finance Leasing is a trading style of Vauxhall Finance plc. Working with the Vauxhall Retailer network we provide competitive car and van leasing solutions for business users and private individuals. We combine the support of a national contract with the convenience of a local contact.

For further information, please contact your local Vauxhall Retailer or visit www.vauxhall.co.uk/leasing

In the event of an accident

Vauxhall Accident Management helps keep you mobile following an accident. Benefits include vehicle recovery, Vauxhall-approved repairs and contacting your insurer. For more details, visit www.vauxhall.co.uk/AccidentManagement

Vehicle Excise Duty

The amount of Vehicle Excise Duty (road fund licence) payable on new cars varies depending on the level of carbon dioxide (CO₂) emissions produced by the vehicle. CO₂ emissions are measured in grams per kilometre (g/km) travelled and divided into 13 charging bands shown in the table opposite.

A 'first year rate' of Vehicle Excise Duty is payable on all new cars and in subsequent years the amount payable reverts to the 'standard rate'. From 1 April 2017 the breakpoints for each of these bands have been revised. Also, for vehicles with a list price over £40,000, including factory-fitted options, an additional £320 is payable for the first five years of standard rate payments.

Vehicle Excise Duty*

Band	CO ₂ emissions in grams per kilometre	First year rate		Standard rate
		Petrol [#]	Diesel [†]	
A	0	£0	£0	£0
B	1-50	£10	£25	£145
C	51-75	£25	£110	£145
D	76-90	£110	£130	£145
E	91-100	£130	£150	£145
F	101-110	£150	£170	£145
G	111-130	£170	£210	£145
H	131-150	£210	£530	£145
I	151-170	£530	£855	£145
J	171-190	£855	£1,280	£145
K	191-225	£1,280	£1,815	£145
L	226-255	£1,815	£2,135	£145
M	over 255	£2,135	£2,135	£145

*Correct at time of issue.

[#]Also applies to diesel vehicles that meet the Real Driving Emissions Step 2 (RDE2).

[†]Applies to vehicles that do not meet the Real Driving Emissions Step 2 (RDE2).

FURTHER INFORMATION

Customer Care Commitment

For added peace of mind, Vauxhall has an innovative Customer Care Commitment that offers the following:

- Three-year vehicle warranty consisting of a one-year/unlimited mileage manufacturer's warranty and a second and third year manufacturer's warranty with a 60,000 miles limitation
- Vauxhall Assistance for 12 months from first registration
- Six years' body panel anti-perforation warranty

Please note: Warranty is only available on vehicles sourced from Vauxhall Motors Limited. Terms and conditions apply – please see your Vauxhall Retailer for details.

Vauxhall Assistance

Vauxhall Assistance is provided automatically with every new Vauxhall for 12 months from first registration and covers everything from accident assistance, roadside recovery and 'at home' service to flat tyres. With Vauxhall Assistance help is literally just a free* phone call away, 24 hours a day, 365 days a year!

Protecting the environment

Vauxhall's commitment to the environment is demonstrated by our products' many environmental awards. For even more information on Vauxhall's efforts to achieve an environmentally sustainable future, and how to dispose of your end-of-life vehicle, see www.vauxhall.co.uk/recycling

Vauxhall Service Plan

- Fixed monthly payments for the plan duration
- Easy to budget and interest-free
- Genuine parts fitted by Vauxhall-trained technicians

Plus on Gold plans:

- Valet and courtesy car
- Vauxhall Roadside Assistance
- Engine flush and fuel treatments
- Litre of oil for top ups between services

Full details can be obtained from your local participating Vauxhall Retailer.

Vauxhall Insurance with added reassurance

Comprehensive cover – Summary of benefits**

- Competitive premiums
- Repairs by a Vauxhall-trained technician
- Genuine Vauxhall parts, guaranteed for three years when we repair your car within our Approved Repairer Network
- Free courtesy car as standard when using an Approved Repairer†
- 24 hour claims helpline
- Personal Accident benefit
- Cover for audio equipment
- Windscreen cover

Call for a quote on **0844 463 2670**††

For more product information

For further information on the Vauxhall range or location of your nearest Vauxhall Retailer please call **0345 600 1500**. Alternatively, details can be found on our website at www.vauxhall.co.uk

*Mobile phone users will be charged at their standard tariff.

**The benefits listed above are for comprehensive cover only. For details of Third Party, Fire and Theft cover, please call our sales team.

†Should your car need repairing following an accident we provide a courtesy car (subject to availability) for the duration of the repair. Only genuine Vauxhall parts are used. Terms and conditions apply.

††Calls may be recorded. Vauxhall Insurance is underwritten by Ageas Insurance Limited.

Take the next step:



Join us online:

Discover the full Vauxhall range at [vauxhall.co.uk](https://www.vauxhall.co.uk) >

Privacy Policy: For full details please visit [vauxhall.co.uk/privacy](https://www.vauxhall.co.uk/privacy)

The invoice price, including delivery to Retailer, factory-fitted options, accessories fitted by the Retailer and number plates, is subject to VAT. Some feature descriptions in this guide may refer to, and some illustrations may show, optional equipment not included in the standard delivery. The information contained in this guide was accurate at the time of publication. We reserve the right to make changes in design and equipment. Please note that Vauxhall Retailers are not the agents of Vauxhall Motors Limited and are not authorised to bind Vauxhall Motors Limited by any specific or implied undertaking or representation. It is advisable to ensure that your motor insurance policy provides adequate cover for additional fitted options and accessories. The colours in this guide are only approximate actual colours. Illustrated optional equipment is available at extra charge. Availability, technical features and equipment provided on our vehicles can vary by model. For precise information on the equipment provided on our vehicles, please contact your local Vauxhall Retailer.

CROSSLAND X

Price and Specification Guide | 1 April 2019 | Model Year 2019.5



VAUXHALL
British Brand since 1903

CONTENTS

To find the information you want use the links below to navigate around the guide:

[RANGE HIGHLIGHTS >](#)

Explore the Crossland X range and find your perfect model.

[MODELS >](#)

Find all the information you need about your chosen model.

[PRICES >](#)

Find on-the-road recommended retail prices.

[FEATURES/OPTIONS >](#)

Tailor your chosen model to suit your needs with everything from satellite navigation to rear-view camera and parking sensors.

[EXTERIOR COLOURS >](#)

Add some sparkle to your car with a metallic paint.

[WHEELS AND TYRES >](#)

Why not upgrade to a set of distinctive alloy wheels to give your car more presence.

[PERFORMANCE, FUEL ECONOMY AND EMISSIONS >](#)

Know how many miles you will get around town, the CO₂ figures and the 0-60 time.

[DIMENSIONS >](#)

Ensure your car will fit in the garage and know how much luggage you can take for a long weekend away.

[SPECIFICATIONS >](#)

Towing weights, engine details and other useful details you may need to know.

[ACCESSORIES >](#)

Add some practical touches to your car with our range of quality accessories.

[COMPANY CAR INFORMATION >](#)

Benefit in Kind company car tax, 3 day test drives and P11D.

[FURTHER INFORMATION >](#)

Price protection, vehicle excise duty, our range of additional products and much more.

CROSSLAND X RANGE HIGHLIGHTS



SE OTR from £17,715

Standard features include:

Infotainment:

- R4.0 IntelliLink system
 - Smartphone projection, Apple CarPlay™ and Android Auto™
 - 7-inch colour touchscreen
 - AM/FM/digital radio
 - Bluetooth® audio streaming/mobile phone portal
 - USB connection with iPod control

Interior convenience/styling:

- Air conditioning
- Cruise control with speed limiter
- Leather-covered steering wheel with audio controls
- Steering column adjustable for reach and rake

Exterior convenience/styling:

- Auto lighting/windscreen wipers
- Silver-effect 16-inch alloy wheels

Safety/security:

- Switchable electronic stability programme
- Anti-lock braking system
- Front camera system
- Hill start assist
- LED daytime running lights

SE NAV OTR from £18,415

SE Nav models additionally feature:

- Navi 5.0 IntelliLink system
 - Fully integrated European sat nav system
 - 8-inch colour touchscreen
 - Voice control
 - Second USB charging connection



TECH LINE NAV OTR from £17,815

Features over SE Nav:

Interior convenience/styling:

- Dual-zone electronic climate control
- Ambient LED lighting
- Flex Floor
- Driver's centre armrest

Exterior convenience/styling:

- Alloy-effect protective front and rear skid plates
- Dark-tinted rear windows
- Chrome-effect side window trim
- 16-inch diamond-cut alloy wheels

Safety/security:

- Remote control security alarm system
- Rear parking distance sensors



ELITE OTR from £18,915

Features over SE:

Interior convenience/styling:

- Dual-zone electronic climate control
- Ambient LED lighting
- Flex Floor
- Driver's centre armrest

Exterior convenience/styling:

- Alloy-effect protective front and rear skid plates
- Dark-tinted rear windows
- Chrome-effect side window trim
- 17-inch diamond-cut alloy wheels

Safety/security:

- Remote control security alarm system
- Rear parking distance sensors

ELITE NAV OTR from £19,615

Elite Nav models additionally feature:

- Navi 5.0 IntelliLink system
 - Fully integrated European sat nav system
 - 8-inch colour touchscreen
 - Voice control
 - Second USB charging connection



ULTIMATE OTR from £23,085

Features over Elite:

Infotainment:

- Navi 5.0 IntelliLink system
 - Fully integrated European sat nav system
 - 8-inch colour touchscreen
 - Voice control
 - Second USB charging system
- Premium sound system

Interior convenience/styling:

- Leather seat facings
- Ergonomic heated active front seats
- Heated leather-covered steering wheel with audio controls
- Versatility Pack
 - Sliding rear seat
 - Centre rear seat armrest
 - Centre rear seat head restraint

Exterior convenience/styling:

- Contrast colour roof
- Door mirrors in roof colour
- Silver-effect roof rails

Safety/security:

- Safety Pack
 - Driver drowsiness system
 - Forward collision alert
 - Automatic emergency braking with pedestrian detection

SE



SE ON-THE-ROAD PRICES

	5-door SUV		Insurance Group
	OTR RRP	CO ₂ (g/km)	
Petrol			
1.2 (83PS)	£17,715	116	8E
1.2 (110PS) Turbo S/S ecoTEC	£19,035	108	13E
1.2 (110PS) Turbo S/S auto	£20,095	125	12E
Diesel			
1.5 (102PS) Turbo D S/S ecoTEC	£19,815	107	14E

SE NAV ON-THE-ROAD PRICES

Petrol			
1.2 (83PS)	£18,415	116	8E
1.2 (110PS) Turbo S/S ecoTEC	£19,735	108	13E
1.2 (110PS) Turbo S/S auto	£20,795	125	12E
Diesel			
1.5 (102PS) Turbo D S/S ecoTEC	£20,515	107	14E

Please note: On-the-road recommended retail prices (RRP) include VAT at 20%, number plates and delivery to Retailer of £700.00 (inc. £116.67 VAT), 12 months' Vehicle Excise Duty and new vehicle first registration fee of £55.00. Excludes fuel and insurance.

All diesel models feature BlueInjection, see www.vauxhall.co.uk/adblue.

S/S = Start/Stop.

FEATURES

Infotainment:

- R4.0 IntelliLink system
 - Smartphone projection, Apple CarPlay™ and Android Auto™
 - 7-inch colour touchscreen
 - AM/FM/digital radio
 - Bluetooth® audio streaming
 - Bluetooth® mobile phone portal
 - USB connection with iPod control

Interior convenience/styling:

- Air conditioning
- Cruise control with speed limiter
- Multi-function trip computer
- Leather-covered steering wheel
- Steering column adjustable for reach and rake
- Steering wheel mounted audio controls
- Auto anti-dazzle rear-view mirror
- 60/40 split-folding rear seat

Exterior convenience/styling:

- Silver-effect 16-inch alloy wheels
- Side-protection mouldings
- Front fog lights
- Auto lighting/windscreen wipers
- Electrically adjustable/heated door mirrors
- Electrically operated front and rear windows
- Remote control central locking

Safety/security:

- Switchable electronic stability programme
- Anti-lock braking system
- Front camera system
 - Lane departure warning
 - Speed sign recognition
- Traction control
- Hill start assist
- Tyre pressure monitoring system
- Six airbags
- Emergency tyre inflation kit in lieu of spare wheel
- LED daytime running lights

SE NAV MODELS

ADDITIONALLY FEATURE

Infotainment:

- Navi 5.0 IntelliLink system
 - Fully integrated European sat nav system
 - 8-inch colour touchscreen
 - Voice control
 - Second USB charging connection

TECH LINE NAV



TECH LINE NAV ON-THE-ROAD PRICES

	5-door SUV		Insurance Group
	OTR RRP	CO ₂ (g/km)	
Petrol			
1.2 (83PS)	£17,815	116	8E
1.2 (110PS) Turbo S/S ecoTEC	£19,135	108	13E
1.2 (110PS) Turbo S/S auto	£20,195	125	12E
1.2 (130PS) Turbo S/S	£19,455	116	17E
Diesel			
1.5 (102PS) Turbo D S/S ecoTEC	£19,915	107	14E

Please note: On-the-road recommended retail prices (RRP) include VAT at 20%, number plates and delivery to Retailer of £700.00 (inc. £116.67 VAT), 12 months' Vehicle Excise Duty and new vehicle first registration fee of £55.00. Excludes fuel and insurance.

All diesel models feature BlueInjection, see www.vauxhall.co.uk/adblue.

S/S = Start/Stop.

FEATURES

Infotainment:

- Navi 5.0 IntelliLink system
 - Fully integrated European sat nav system
 - Smartphone projection, Apple CarPlay™ and Android Auto™
 - 8-inch colour touchscreen
 - AM/FM/digital radio
 - Bluetooth® audio streaming
 - Bluetooth® mobile phone portal
 - Voice control
 - USB connection with iPod control

Interior convenience/styling:

- Dual-zone electronic climate control
- Cruise control with speed limiter
- Multi-function trip computer
- Leather-covered steering wheel
- Steering column adjustable for reach and rake
- Steering wheel mounted audio controls
- Driver's centre armrest
- Auto anti-dazzle rear-view mirror
- 60/40 split-folding rear seat
- Ambient LED lighting
- Flex Floor

Exterior convenience/styling:

- 16-inch diamond-cut alloy wheels
- Alloy-effect protective front and rear skid plates
- Side-protection mouldings
- Front fog lights
- Auto lighting/windscreen wipers
- Electrically adjustable/heated door mirrors
- Electrically operated front and rear windows
- Remote control central locking
- Dark tinted rear windows
- Chrome-effect side window trim

Safety/security:

- Switchable electronic stability programme
- Anti-lock braking system
- Front camera system
 - Lane departure warning
 - Speed sign recognition
- Traction control
- Hill start assist
- Tyre pressure monitoring system
- Six airbags
- Remote control security alarm system
- Rear parking distance sensors
- Emergency tyre inflation kit in lieu of spare wheel
- LED daytime running lights

ELITE



ELITE ON-THE-ROAD PRICES

	5-door SUV		Insurance Group
	OTR RRP	CO ₂ (g/km)	
Petrol			
1.2 (83PS)	£18,915	117	8E
1.2 (110PS) Turbo S/S ecoTEC	£20,235	108	14E
1.2 (110PS) Turbo S/S auto	£21,295	128	12E
1.2 (130PS) Turbo S/S	£20,555	118	18E
Diesel			
1.5 (102PS) Turbo D S/S ecoTEC	£21,015	107	14E

ELITE NAV ON-THE-ROAD PRICES

	5-door SUV		Insurance Group
	OTR RRP	CO ₂ (g/km)	
Petrol			
1.2 (83PS)	£19,615	117	8E
1.2 (110PS) Turbo S/S ecoTEC	£20,935	108	14E
1.2 (110PS) Turbo S/S auto	£21,995	128	12E
1.2 (130PS) Turbo S/S	£21,255	118	18E
Diesel			
1.5 (102PS) Turbo D S/S ecoTEC	£21,715	107	14E

Please note: On-the-road recommended retail prices (RRP) include VAT at 20%, number plates and delivery to Retailer of £700.00 (inc. £116.67 VAT), 12 months' Vehicle Excise Duty and new vehicle first registration fee of £55.00. Excludes fuel and insurance.

All diesel models feature BlueInjection, see www.vauxhall.co.uk/adblue.

S/S = Start/Stop.

FEATURES

Infotainment:

- R4.0 IntelliLink system
 - Smartphone projection, Apple CarPlay™ and Android Auto™
 - 7-inch colour touchscreen
 - AM/FM/digital radio
 - Bluetooth® audio streaming
 - Bluetooth® mobile phone portal
 - USB connection with iPod control

Interior convenience/styling:

- Dual-zone electronic climate control
- Cruise control with speed limiter
- Multi-function trip computer
- Leather-covered steering wheel
- Steering column adjustable for reach and rake
- Steering wheel mounted audio controls
- Auto anti-dazzle rear-view mirror
- Driver's centre armrest
- 60/40 split-folding rear seat
- Ambient LED lighting
- Flex Floor

Exterior convenience/styling:

- 17-inch diamond-cut alloy wheels
- Alloy-effect protective front and rear skid plates
- Side-protection mouldings
- Front fog lights
- Auto lighting/windscreen wipers

- Electrically adjustable/heated door mirrors
- Electrically operated front and rear windows
- Dark-tinted rear windows
- Chrome-effect side window trim

Safety/security:

- Switchable electronic stability programme
- Anti-lock braking system
- Front camera system
 - Lane departure warning
 - Speed sign recognition
- Traction control/hill start assist
- Tyre pressure monitoring system
- Six airbags
- Remote control central locking/alarm system
- Rear parking distance sensors
- Emergency tyre inflation kit in lieu of spare wheel
- LED daytime running lights

ELITE NAV MODELS ADDITIONALLY FEATURE

Infotainment:

- Navi 5.0 IntelliLink system
 - Fully integrated European sat nav system
 - 8-inch colour touchscreen
 - Voice control
 - Second USB charging connection

ULTIMATE



ULTIMATE ON-THE-ROAD PRICES

	5-door SUV		Insurance Group
	OTR RRP	CO ₂ (g/km)	
Petrol			
1.2 (110PS) Turbo S/S ecoTEC	£23,085	108	14E
1.2 (110PS) Turbo S/S auto	£24,145	128	12E
1.2 (130PS) Turbo S/S	£23,405	118	18E

Please note: On-the-road recommended retail prices (RRP) include VAT at 20%, number plates and delivery to Retailer of £700.00 (inc. £116.67 VAT), 12 months' Vehicle Excise Duty and new vehicle first registration fee of £55.00. Excludes fuel and insurance.

S/S = Start/Stop.

FEATURES

Infotainment:

- Navi 5.0 IntelliLink system
 - Fully integrated European sat nav system
 - Smartphone projection, Apple CarPlay™ and Android Auto™
 - 8-inch colour touchscreen
 - AM/FM/digital radio
 - Bluetooth® audio streaming
 - Bluetooth® mobile phone portal
 - Voice control
 - USB connection with iPod control
 - Second USB charging connection
- Premium sound system

Interior convenience/styling:

- Dual-zone electronic climate control
- Cruise control with speed limiter
- Multi-function trip computer
- Leather seat facings
- Ergonomic heated active front seats
- Heated leather-covered steering wheel with audio controls
- Steering column adjustable for reach and rake
- Steering wheel mounted audio controls
- Auto anti-dazzle rear-view mirror
- Driver's centre armrest
- Versatility Pack

Exterior convenience/styling:

- 17-inch diamond-cut alloy wheel
- Alloy-effect protective front and rear skid plates
- Contrast colour roof/door mirrors
- Silver-effect roof rails
- Side-protection mouldings
- Front fog lights
- Auto lighting/windscreen wipers
- Electrically adjustable/heated door mirrors
- Electrically operated front and rear windows
- Dark-tinted rear windows
- Chrome-effect side window trim

Safety/security:

- Switchable electronic stability programme
- Anti-lock braking system
- Safety Pack
 - Driver drowsiness system
 - Forward collision alert
 - Automatic emergency braking with pedestrian detection
- Front camera system
- Tyre pressure monitoring system
- Six airbags
- Remote control central locking/alarm system
- Rear parking distance sensors
- Emergency tyre inflation kit in lieu of spare wheel
- LED daytime running lights

CROSSLAND X PRICES

	Price (£)	VAT (£)	Total (£)	On-the-road RRP (£)	BiK 20% (£)	CO ₂ (g/km)
SE						
1.2 (83PS)	13,991.67	2,798.33	16,790.00	17,715.00	78.70	116
1.2 (110PS) Turbo S/S ecoTEC	15,108.33	3,021.67	18,130.00	19,035.00	78.45	108
1.2 (110PS) Turbo S/S auto	15,975.00	3,195.00	19,170.00	20,095.00	96.03	125
Diesel						
1.5 (102PS) Turbo D S/S ecoTEC	15,741.67	3,148.33	18,890.00	19,815.00	94.68	107
SE NAV						
1.2 (83PS)	14,575.00	2,915.00	17,490.00	18,415.00	81.85	116
1.2 (110PS) Turbo S/S ecoTEC	15,691.67	3,138.33	18,830.00	19,735.00	81.37	108
1.2 (110PS) Turbo S/S auto	16,558.33	3,311.67	19,870.00	20,795.00	99.42	125
Diesel						
1.5 (102PS) Turbo D S/S ecoTEC	16,325.00	3,265.00	19,590.00	20,515.00	98.07	107
TECH LINE NAV						
1.2 (83PS)	14,075.00	2,815.00	16,890.00	17,815.00	79.15	116
1.2 (110PS) Turbo S/S ecoTEC	15,191.67	3,038.33	18,230.00	19,135.00	78.87	108
1.2 (110PS) Turbo S/S auto	16,058.33	3,211.67	19,270.00	20,195.00	96.52	125
1.2 (130PS) Turbo S/S	15,441.67	3,088.33	18,530.00	19,455.00	86.53	116
Diesel						
1.5 (102PS) Turbo D S/S ecoTEC	15,825.00	3,165.00	18,990.00	19,915.00	95.17	107

	Price (£)	VAT (£)	Total (£)	On-the-road RRP (£)	BiK 20% (£)	CO ₂ (g/km)
ELITE						
1.2 (83PS)	14,991.67	2,998.33	17,990.00	18,915.00	84.10	117
1.2 (110PS) Turbo S/S ecoTEC	16,108.33	3,221.67	19,330.00	20,235.00	83.45	108
1.2 (110PS) Turbo S/S auto	16,975.00	3,395.00	20,370.00	21,295.00	101.83	128
1.2 (130PS) Turbo S/S	16,358.33	3,271.67	19,630.00	20,555.00	91.48	118
Diesel						
1.5 (102PS) Turbo D S/S ecoTEC	16,741.67	3,348.33	20,090.00	21,015.00	100.48	107
ELITE NAV						
1.2 (83PS)	15,575.00	3,115.00	18,690.00	19,615.00	87.25	117
1.2 (110PS) Turbo S/S ecoTEC	16,691.67	3,338.33	20,030.00	20,935.00	86.37	108
1.2 (110PS) Turbo S/S auto	17,558.33	3,511.67	21,070.00	21,995.00	105.22	128
1.2 (130PS) Turbo S/S	16,941.67	3,388.33	20,330.00	21,255.00	94.63	118
Diesel						
1.5 (102PS) Turbo D S/S ecoTEC	17,325.00	3,465.00	20,790.00	21,715.00	103.87	107
ULTIMATE						
1.2 (110PS) Turbo S/S ecoTEC	18,483.33	3,696.67	22,180.00	23,085.00	95.32	108
1.2 (110PS) Turbo S/S auto	19,350.00	3,870.00	23,220.00	24,145.00	115.60	128
1.2 (130PS) Turbo S/S	18,733.33	3,746.67	22,480.00	23,405.00	104.30	118

S/S = Start/Stop.

All diesel models feature BlueInjection. Vehicles with BlueInjection technology will need regular AdBlue® top-ups also between servicing requirements. An indicator integrated into the on-board computer will warn you when you need to top up. More information see www.vauxhall.co.uk/adblue. In accordance with regulations R (EC) No. 715/2007 and R (EC) No. 692/2008 (in the versions respectively applicable).

Please note: On-the-road recommended retail prices (RRP) include number plates and delivery to retailer of £700.00 (inc. £116.67 VAT), 12 months' Vehicle Excise Duty and new vehicle first registration fee of £55.00. Excludes fuel and insurance. Company Car Benefit in Kind (BiK) rates are monthly based on the standard paint price.

STANDARD FEATURES

ALL MODELS

Driver/passenger airbags

- Driver's and front passenger's airbags with active-vent technology – Adapts the airbag pressure based on the position of the seat, reducing it the closer the seat is to the fascia.
 - Front seat side-impact airbags
 - Full-size curtain airbags for driver, front seat passenger and outer rear seat passengers
-

Seating

- Height-adjustable front seat head restraints • Height-adjustable outer rear seat head restraints
 - Anti-submarining ramps in front seats
-

Seatbelts

- Inertia-reel lap and diagonal seatbelts for all seats
 - Dual seatbelt pretensioners on front seats – These keep the pelvis better coupled to the vehicle in an impact; the pelvis and therefore the legs are allowed less forward movement, reducing the risk of hard knee contact with the fascia.
 - Pretensioners on outer rear seatbelt retractors • Load limiters on front and outer rear seatbelt retractors
 - Smart seatbelt reminder for front and rear seats – Warning lights and audible warning.
-

Child safety

- Deactivation switch for front passenger's front and side-impact airbags – Permits the safe use of a child seat in the front passenger seat.
 - ISOFIX child seat mountings incorporating top tether anchor points located on outer rear seats (does not include child seat) – Allows ISOFIX child safety seats to be securely fixed into the car. The ISOFIX mounting system reduces forward movement in an accident and makes the child seat easier to install.
 - Child-proof locks on rear doors
-

Driver/passenger safety

- Energy-absorbing steering column • Side-impact protection beams
 - Reinforced passenger safety cell • Deformation zones front and rear
-

Pedestrian safety

- Collapsible windscreen wiper system – Designed to reduce pedestrian head injuries.
 - Upper and lower bumper design – Reduces upper and lower leg injuries.
-

Braking and stability

- Switchable Electronic Stability Programme (ESP) • Anti-lock Braking System (ABS)
 - Corner stability control • Traction control • Hill start assist
 - Engine drag torque control – Improves directional stability by preventing the driven wheels from locking on slippery surfaces under the influence of engine braking.
 - Hydraulic brake assist • Hydraulic brake boost • Electronic brakeforce distribution
-

Tyre pressure

- Deflation detection system
-

STANDARD FEATURES

ALL MODELS

Steering

- Speed-sensitive power-assisted steering
 - Reach and rake adjustable steering
-

Cruise control with speed limiter and intelligent speed adaptation

Cruise control feature – enables you to maintain a constant speed – making it ideal for economical motorway driving. The speed limiter function – can be set to ensure that you do not exceed the speed limit and can be easily overridden if required. Working in conjunction with speed sign recognition, when a new speed limit is detected a message appears in the driver information display. You can then set the cruise control to the new speed limit with a simple press on a steering wheel button.

- Steering wheel mounted controls
-

Front camera system

A range of driver assistance and safety features are controlled by the front camera system.

Lane departure warning: If the driver has not actively steered or signalled, the lane departure warning system warns when the car moves outside of lane markings at speeds above 37mph.

- Warning light in instrument cluster
- Audible warning
- Facia on/off switch

Traffic sign recognition: Detects and then displays speed limits, reducing uncertainty and the risk of speeding.

- Recognises different road signs, including temporary speed restrictions
 - Displays reminder in the instrument cluster
 - On Nav models, where the front camera system is unable to detect any speed signs the speed limit stored in the navigation database will be displayed
-

Security features

- Electronically protected audio equipment
 - Engine deadlock immobiliser
 - Visible Vehicle Identification Number (VIN)
 - Locking wheel bolts for alloy wheels
 - Luggage area cover
-

Remote control central locking

- Operates on doors, tailgate and fuel filler flap
 - Deadlocking
 - Driver's internal central locking activation switch
-

Instrumentation

- Speedometer
 - Rev counter
 - Fuel gauge with low fuel level warning light
 - Water temperature gauge with warning light
 - Shift-up indication light – Indicates when to change gear for optimum fuel economy
-

Driver information display (centrally located in instrument cluster)

- Displays trip computer data
 - Total mileage
 - Service-due indicator
 - Tyre pressure monitoring system
 - Monochrome display (non-Nav models)
 - 3.5-inch colour information display – On SE models, only on Nav variants or in conjunction with optional Navi 5.0
-

Multi-function trip computer (displayed on driver information display)

- Trip mileage
 - Vehicle range based on remaining fuel
 - Average speed
 - Average fuel economy
 - Instantaneous fuel economy
-

Central facia display (format dependent on infotainment unit)

- Audio information
 - Digital clock with automatic RDS time adjustment
 - Outside air temperature with ice warning function
 - Additional features dependent on infotainment unit (see infotainment for details)
-

Audio features

- Six speakers (four front, two rear)
 - Steering wheel mounted audio controls
-

Rear seating

- Three-person layout
 - 60/40 split-folding rear seat
 - Height-adjustable and removable outer seat head restraints
-

Additional heating and ventilation features

- Four adjustable facia vents
 - Windscreen demist vents
 - Side window demist vents
 - Heated rear screen with timed cut-off
-

Convenience features

- Front 12-volt electrical accessory socket
 - Front and rear passenger assist handles
 - Driver's and front passenger's illuminated vanity mirrors with flip-up cover
 - Automatically dimming anti-dazzle rear-view mirror
-

STANDARD FEATURES

ALL MODELS

Interior lighting

- Courtesy lighting operated by door switches • Rear courtesy light with reading lights
-

Interior storage

- Glovebox with lid • Front door pockets with 1.5-litre bottle holder • Two drinks holders in centre console • Rear door pockets with 0.5-litre bottle holder • Open storage compartment in centre console
-

Luggage area

- Luggage compartment foldable cover • Illuminated luggage area • Fully carpeted luggage area
-

Exterior lighting features

- Front fog lights • LED daytime running lights • Automatic lighting control with tunnel detection • Halogen headlights • Lights-on audible warning • Manual headlight beam levelling • High-level LED centre rear brake light • Rear fog light • Reversing light • Hazard warning lights • Door-to-door illumination • Welcome lighting
-

Front fog lights

Windscreen wipers

- Two-speed windscreen wipers with variable intermittent wipe • Intermittent rear window wash/wipe • Rain-sensitive windscreen wipers
-

Door mirrors

- Twin electrically adjustable/heated door mirrors (wide-angle on driver's side) with automatic timed cut-off • Manually foldable door mirrors
-

Windows

- Electrically operated front and rear windows with safety autoreverse and one-touch facility • Heated rear window • Solar heat-absorbing windscreen • Tinted windows
-

Body styling

- Side-protection mouldings • Chrome-effect front grille bar • Body-colour door handles • Rear spoiler
-

FEATURES/OPTIONS

DRIVER ASSISTANCE

	SE/SE Nav	Tech Line Nav	Elite/ Elite Nav	Ultimate	Price (£) exc. VAT	Price (£) inc. VAT
Safety Pack						
Driver drowsiness system The system monitors driving time and driving behaviour to help prevent accidents caused by tiredness.						
Forward collision alert The system operates automatically from 3mph and gives an audible warning as well as a visual warning when approaching another vehicle too quickly.						
Automatic emergency braking with pedestrian detection The system works automatically in conjunction with forward collision alert, at speeds between 3mph and 53mph, and detects both vehicles and pedestrians. If no avoiding action is taken by the driver, at speeds below 19mph the system automatically slows the vehicle to a full stop with emergency braking of 0.9g. At speeds from 19mph to 53mph it brakes automatically to reduce speed by a maximum of 14mph – to reduce speed even further the driver must brake him/herself. The operational speed range of the system depends on the detected obstacle (mobile target: from 3 to 53mph; fixed target: from 3 to 50mph; pedestrian: from 3 to 37mph). Vauxhall driver assistance systems are intended to support the driver within the system-imminent limitations. The driver remains responsible for the driving task.						
	○	○	○	●	416.67	500.00
Rear-view Camera Pack (available on non-Nav models only)						
Rear-view camera The rear-view camera gives a clear view of the area behind your car and helps place the car perfectly, without needing to strain your neck. • Activated when reverse gear selected • Camera view appears in infotainment screen • Rear bumper and grid lines shown as reference points						
	○				466.67	560.00
Front and rear parking distance sensors An audible warning alerts you to obstacles in front of and behind you. A series of beeps are sounded as you approach the obstacle, increasing in frequency as the distance closes.						
			○		279.17	335.00

● = Standard equipment. ○ = Optional at extra cost.

FEATURES/OPTIONS

DRIVER ASSISTANCE CONTINUED

	SE/SE Nav	Tech Line Nav	Elite/ Elite Nav	Ultimate	Price (£) exc. VAT	Price (£) inc. VAT
Rear-view Camera Pack Plus (available on Nav models, and in conjunction with optional Navi 5.0)						
Panoramic rear-view camera						
The rear-view camera gives a clear view of the area behind your car and helps place the car perfectly, without needing to strain your neck.						
<ul style="list-style-type: none"> • The 180° panoramic view detects traffic coming from the side, helping you reverse out of perpendicular parking spaces more safely • Overhead view allows you to see clearly how close you are to obstacles behind you • Activated when reverse gear selected • Camera view appears in infotainment screen • Rear bumper and grid lines shown as reference points 						
Front and rear parking distance sensors						
An audible warning alerts you to obstacles in front of and behind you. A series of beeps are sounded as you approach the obstacle, increasing in frequency as the distance closes.						
Parking sensors						
• Rear parking distance sensors – audible warning						
• Front and rear parking distance sensors • Audible warning						
	○				400.00	480.00
		○	○	○	200.00	240.00

SECURITY

Remote control central locking						
• One folding key/one static key, each with integral remote control function						
Remote control central locking						
• Two folding keys, each with integral remote control function						
Remote control security alarm system						
• Remote control (operates in conjunction with central locking) – SE and SE Nav models include a second folding key.						
	○	●	●	●	216.67	260.00

● = Standard equipment. ○ = Optional at extra cost.

FEATURES/OPTIONS

INTERIOR STYLING

	SE/SE Nav	Tech Line Nav	Elite/ Elite Nav	Ultimate	Price (£) exc. VAT	Price (£) inc. VAT
SE/SE Nav interior décor Steering wheel: • Three-spoke design • Leather-covered • Satin chrome-effect bezel Facia and door trim: • Light gravel facia and door panel inserts • Black door panels with black Atlantis cloth inserts • Chrome-effect interior door handles Infotainment surround: • Piano black	●					
Tech Line Nav interior décor Steering wheel: • Three-spoke design • Leather-covered • Satin chrome-effect bezel Facia and door trim: • Tioga grey facia and door panel inserts • Black door panels with medium grey Premium leather-effect inserts • Chrome-effect interior door handles Infotainment surround: • Piano black		●				
Elite/Elite Nav interior décor Steering wheel: • Three-spoke design • Leather-covered • Satin chrome-effect bezel Facia and door trim: • Tioga grey facia and door panel inserts • Black door panels with medium grey Premium leather-effect inserts • Chrome-effect interior door handles Infotainment surround: • Piano black			●			
Ultimate interior décor Steering wheel: • Three-spoke design • Leather-covered • Satin chrome-effect bezel" Facia and door trim: • Tioga grey facia and door panel inserts • Jet black door panels with medium grey Premium leather-effect inserts • Chrome-effect interior door handles Infotainment surround: • Piano black				●		

● = Standard equipment.

FEATURES/OPTIONS

INFOTAINMENT

	SE/SE Nav	Tech Line Nav	Elite/ Elite Nav	Ultimate	Price (£) exc. VAT	Price (£) inc. VAT
<p>R4.0 IntelliLink touchscreen infotainment system – for use with media players, USB memory sticks, mobile phones and smartphone apps.</p> <p>Onboard features:</p> <ul style="list-style-type: none"> • 7-inch colour touchscreen • AM/FM stereo radio with 36 station presets • RDS with Traffic Programme <p>Media connections:</p> <ul style="list-style-type: none"> • USB connection with iPod control • Bluetooth® A2DP audio streaming (Advanced Audio Distribution Profile) <p>Mobile phone portal:</p> <ul style="list-style-type: none"> • Bluetooth® connectivity • Handsfree calls via steering wheel controls • Vehicle microphone • Phone book access – The majority of the phone’s functions – contacts/last calls/missed calls etc. are mirrored on IntelliLink’s display and are easily navigated using the touchscreen (features dependent on mobile phone). <p>Smartphone interface:</p> <ul style="list-style-type: none"> • Apple CarPlay™ • Android Auto™ 	▲		▲			
<p>Navi 5.0 IntelliLink touchscreen navigation and infotainment system for use with media players, USB memory sticks, mobile phones and smartphone apps.</p> <p>Onboard features:</p> <ul style="list-style-type: none"> • 8-inch colour touchscreen • Digital radio/AM/FM stereo radio • RDS with Traffic Programme <p>Navigation features:</p> <ul style="list-style-type: none"> • Satellite navigation system • 3D street level mapping • European coverage <p>Media connections:</p> <ul style="list-style-type: none"> • 2 USB connections, upper with iPod control and smartphone projection functions • Bluetooth® A2DP audio streaming (Advanced Audio Distribution Profile) <p>Mobile phone portal:</p> <ul style="list-style-type: none"> • Bluetooth® connectivity • Handsfree calls via steering wheel controls • Vehicle microphone • Phone book access – The majority of the phone’s functions – contacts/last calls/missed calls etc. are mirrored on IntelliLink’s display and are easily navigated using the touchscreen (features dependent on mobile phone). <p>Smartphone interface:</p> <ul style="list-style-type: none"> • Apple CarPlay™ • Android Auto™ 	■	●	■	●	591.67	710.00
<p>Premium sound system</p> <ul style="list-style-type: none"> • Six speakers • Subwoofer • Separate amplifier for subwoofer 				●		

● = Standard equipment. ▲ = See price page for details. ■ = Standard on Nav models. Optional at extra cost on non-Nav models.

FEATURES/OPTIONS

SEATING AND COMFORT

	SE/SE Nav	Tech Line Nav	Elite/ Elite Nav	Ultimate	Price (£) exc. VAT	Price (£) inc. VAT
Comfort front seats Driver's seat (eight-way adjustable): • Height (up/down) • Reach (fore/aft) • Backrest (upright/recline) • Head restraint (up/down) Front passenger's seat (six-way adjustable): • Reach (fore/aft) • Backrest (upright/recline) • Head restraint (up/down)	●	●	●			
Seat trim: • Peanut black fabric seat trim inserts • Plain black fabric side bolsters	●					
• Florey black fabric seat trim inserts • Medium grey fabric inner side bolsters • Black leather-effect outer side bolsters		●	●			
Front Seats Comfort Pack <hr/> Driver's and front passenger's seats (12-way adjustable): • Height • Reach • Backrest • Lumbar adjustment (four-way electrical) • Head restraint Seat trim: • Peanut black fabric seat trim inserts • Plain black fabric side bolsters <hr/> • Florey black fabric seat trim inserts • Medium grey fabric inner side bolsters • Black leather-effect outer side bolsters	○				275.00	330.00
		○	○		275.00	330.00

● = Standard equipment. ○ = Optional at extra cost.

FEATURES/OPTIONS

SEATING AND COMFORT CONTINUED

	SE/SE Nav	Tech Line Nav	Elite/ Elite Nav	Ultimate	Price (£) exc. VAT	Price (£) inc. VAT
Ergonomic active front seats (AGR-approved)* Driver's and front passenger's seat (16-way adjustable): • Height • Reach • Tilt (electrical) • Backrest • Seat cushion extension • Lumbar adjustment (four-way electrical) • Head restraint Convenience features: • 12-volt power outlet behind front seats • Covered storage compartment in centre console				●		
Seat trim: • Florey black fabric seat trim inserts • Medium grey fabric inner side bolsters • Black leather-effect outer side bolsters	○				437.50	525.00
• Florey black fabric seat trim inserts • Medium grey fabric inner side bolsters • Black leather-effect outer side bolsters		○	○		354.17	425.00
• Siena leather seat trim inserts and inner side bolsters • Black premium leather-effect outer side bolsters • Jet black stitching		○	○	●	1,208.33	1,450.00
Centre rear seat head restraint Fitted in conjunction with Versatility Pack. Not available separately.	□	□	□	●		

HEATING AND VENTILATION

Air conditioning • Air recirculation facility • Cabin particular filter – removes dust, airborne particles and pollen • Multi-speed fan • Illuminated controls	●					
Electronic climate control with air conditioning • Dual-zone control – allows different temperature settings for driver and front passenger • Advanced predictive logic control system using a sun sensor • Charcoal filter – removes dust, airborne particles, pollen and unpleasant odours • Automatic air direction and fan speed with manual override • Illuminated controls		●	●	●		
Winter Pack  • Heated front seats • Electrically heated leather-covered steering wheel	○	○	○	●	295.83	355.00

*AGR (The Campaign for Healthier Backs) is an independent centre of excellence for ergonomics, based in Germany.

● = Standard equipment. ○ = Optional at extra cost. □ = Available as part of an extra-cost option pack.

FEATURES/OPTIONS

INTERIOR CONVENIENCE

	SE/SE Nav	Tech Line Nav	Elite/ Elite Nav	Ultimate	Price (£) exc. VAT	Price (£) inc. VAT
12-volt power outlet behind front seats – Fitted in conjunction with ergonomic active front seats. Not available separately.	☐	☐	☐	●		
Driver's centre armrest		●	●	●		
Versatility Pack						
<ul style="list-style-type: none"> • Sliding 60/40 rear seat base • Centre rear seat armrest and ski flap allowing access to luggage compartment • Adjustable rear seat backrest • 60/40 split-folding rear seat back • Centre rear seat head restraint • Flex Floor with under-floor divider – Standard on Tech Line Nav, Elite, Elite Nav and Ultimate models 	○	○	○	●	312.50	375.00

INTERIOR LIGHTING

Premium lighting		●	●	●		
• Ambient facia/centre console downlighter • Ambient LED lighting in front doors, facia and gear shift surround • Front map reading lights						

INTERIOR STORAGE

• Covered storage compartment in centre console – Fitted in conjunction with ergonomic active front seats. Not available separately.	☐	☐	☐	☐		
• Storage pocket on front seat backs – On SE and SE Nav models, fitted in conjunction with ergonomic active front seats. Not available separately.	○	●	●	●		
• Flex Floor with under-floor divider – On SE and SE Nav models, fitted in conjunction with Versatility Pack. Not available separately.	☐	●	●	●		

● = Standard equipment. ○ = Optional at extra cost. ☐ = Available as part of an extra-cost option pack.

FEATURES/OPTIONS

EXTERIOR LIGHTING

	SE/SE Nav	Tech Line Nav	Elite/ Elite Nav	Ultimate	Price (£) exc. VAT	Price (£) inc. VAT
LED tail lights	○	○	○	○	166.67	200.00
Premium LED Lighting Pack						
LED elements light the road brighter than halogen, allowing you to see hazards sooner and giving you more time to react. The system uses data such as vehicle speed, steering angle and when the indicators are used to determine the most suitable lighting. • Static cornering light – At lower speeds, when you indicate and turn the steering above a certain angle, corners and bends are illuminated to match steering inputs. • Intelligent main beam control – Powerful down-the-road illumination on top of the LED low beam. • Automatic headlight levelling • LED tail lights	○	○	○	○	625.00	750.00

EXTERIOR CONVENIENCE







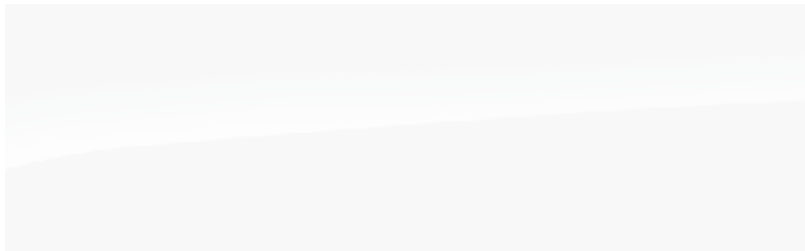

Heated windscreen (operated by heated rear window button)		○	○	○	83.33	100.00
Fixed panoramic glass roof panel with electrically operated sunblind (not available on 1.2 (83PS) models) – Includes silver-effect roof rails.	○	○	○	○	579.17	695.00
Roof rails, silver-effect	○	○	○	●	125.00	150.00
Detachable tow bar	○	○	○	○	458.33	550.00

EXTERIOR STYLING

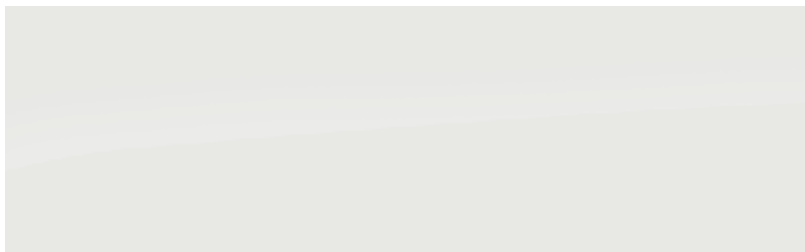
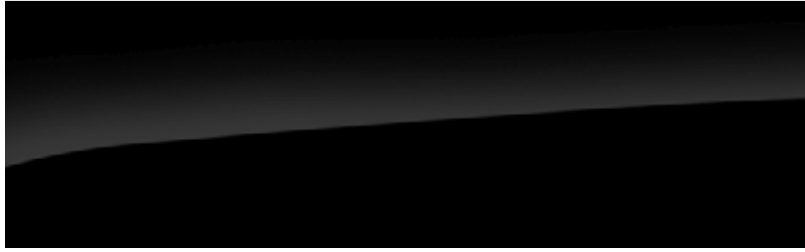
Body styling • Alloy-effect protective front and rear skid plates		●	●	●		
• Chrome-effect side window trim		●	●	●		
Windows • Dark-tinted rear windows		●	●	●		

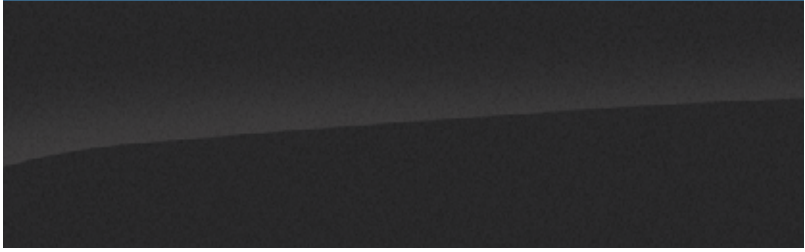
● = Standard equipment. ○ = Optional at extra cost.



EXTERIOR COLOURS

				SE/SE Nav	Tech Line Nav	Elite/ Elite Nav	Ultimate	Price (£) exc. VAT	Price (£) inc. VAT
Solid		Aegean Blue • Not available with Mineral Black roof		●	●	●	●		
Brilliant		Summit White		○	○	○	○	237.50	285.00
Two-coat	 	Sovereign Silver metallic Mineral Black metallic	 	○	○	○	○	479.17	575.00
Two-coat	 	Amber Orange premium Darkmoon Blue Premium • Not available with Mineral Black roof		○	○	○	○	545.83	655.00

The colours reproduced may vary slightly from the actual paint colour. As a result they should be used as a guide only. Your Vauxhall Retailer has a comprehensive display of our paint samples.

● = Standard equipment. ○ = Optional at extra cost.



ROOF AND DOOR MIRROR COLOURS

	SE/SE Nav	Tech Line Nav	Elite/ Elite Nav	Ultimate	Price (£) exc. VAT	Price (£) inc. VAT
Body-colour	●	●	●	N/C	No-cost option	
 <p>Mineral Black • Not available with Aegean Blue, Mineral Black and Darkmoon Blue exterior colours</p>		○	○	●	333.33	400.00
 <p>Summit White • Standard on Ultimate models with Aegean Blue, Mineral Black and Darkmoon Blue exterior colours • Not available with Summit White and Rioja Red exterior colours</p>		○	○	N/C	333.33	400.00

The colours reproduced may vary slightly from the actual paint colour. As a result they should be used as a guide only. Your Vauxhall Retailer has a comprehensive display of our paint samples.



● = Standard equipment. ○ = Optional at extra cost. N/C = No-cost option.

WHEELS AND TYRES

	SE/SE Nav	Tech Line Nav	Elite/ Elite Nav	Ultimate	Price (£) exc. VAT	Price (£) inc. VAT
<p>16-inch steel emergency spare wheel (in lieu of emergency tyre inflation kit).</p>	○	○	○		91.67	110.00
 <p>16-inch silver-effect four twin-spoke alloy wheels</p> <ul style="list-style-type: none"> • 205/60 R 16 ultra low rolling resistance tyres • Emergency tyre inflation kit (in lieu of spare wheel) 	●					
 <p>16-inch diamond-cut titan four twin-spoke alloy wheels</p> <ul style="list-style-type: none"> • 205/60 R 16 ultra low rolling resistance tyres • Emergency tyre inflation kit (in lieu of spare wheel) 		●				
 <p>17-inch diamond-cut Technical Grey multi-spoke alloy wheels</p> <ul style="list-style-type: none"> • 215/50 R 17 tyres • Emergency tyre inflation kit (in lieu of spare wheel) 			●	●		

● = Standard equipment.

WHEELS AND TYRES

	SE/SE Nav	Tech Line Nav	Elite/ Elite Nav	Ultimate	Price (£) exc. VAT	Price (£) inc. VAT
 <p>17-inch silver-effect twin-spoke alloy wheels</p> <ul style="list-style-type: none"> • 215/50 R 17 tyres • Emergency tyre inflation kit (in lieu of spare wheel) 	○	○			333.33	400.00
 <p>17-inch diamond-cut titan multi-spoke alloy wheels</p> <ul style="list-style-type: none"> • 215/50 R 17 tyres • Emergency tyre inflation kit (in lieu of spare wheel) 			○	○	83.33	100.00

○ = Optional at extra cost.

PERFORMANCE, FUEL ECONOMY AND EMISSIONS

	Performance (manufacturer's figures)			Fuel economy mpg (litres/100km)#		CO ₂ emissions g/km*	Vehicle Excise Duty**		Benefit in kind company car taxation rates - 2019/20 tax year
	Wheel size (inches)	Maximum speed (mph)	Acceleration 0-60mph (sec)	Combined Low	Combined High		First year rate	Standard rate	
Petrol models									
1.2 (83PS)	16	106	13.6	42.2 (6.7)	46.3 (6.1)	116	£170	£145	27%
1.2 (83PS)	17	106	13.6	42.2 (6.7)	46.3 (6.1)	117	£170	£145	27%
1.2 (110PS) Turbo Start/Stop ecoTEC	16	116	10.2	44.8 (6.3)	47.1 (6.0)	108	£150	£145	25%
1.2 (110PS) Turbo Start/Stop ecoTEC	17	116	10.2	44.8 (6.3)	47.1 (6.0)	108	£150	£145	25%
1.2 (110PS) Turbo Start/Stop auto	16	116	11.1	39.8 (7.1)	42.2 (6.7)	125	£170	£145	29%
1.2 (110PS) Turbo Start/Stop auto	17	116	11.1	39.8 (7.1)	42.2 (6.7)	128	£170	£145	29%
1.2 (130PS) Turbo Start/Stop	16	125	9.3	43.5 (6.5)	44.8 (6.3)	116	£170	£145	27%
1.2 (130PS) Turbo Start/Stop	17	125	9.3	43.5 (6.5)	44.8 (6.3)	118	£170	£145	27%
Diesel models									
1.5 (102PS) Turbo D Start/Stop ecoTEC	16/17	111	11.0	55.4 (5.1)	60.1 (4.7)	107	£170	£145	29%

#Fuel consumption figures are determined according to the WLTP test cycle. Full data relating to WLTP test cycles can be found at: www.vauxhall.co.uk/wltp

*CO₂ emissions figures are determined according to the WLTP test cycle however, a Government formula is then applied to translate these figures back to what they would have been under the outgoing NEDC test cycle, which WLTP replaces. The correct tax treatment is then applied.

Figures are intended for comparability purposes only. The fuel consumption you achieve under real life driving conditions and CO₂ produced will depend upon a number of factors, including the accessories fitted after registration, variations in driving styles, weather conditions and vehicle load. Only compare fuel consumption and CO₂ with other vehicles tested using the same technical procedures. For more information contact your local Vauxhall Retailer.

**Correct at time of publication.

DIMENSIONS

Loadspace Dimensions

Maximum length (behind rear seats)	793 (31.2)
Maximum length (rear seats folded)	1483 (58.4)
Maximum width	1000 (39.4)
Width between wheel arches	947 (37.3)
Maximum height	894 (35.2)
Luggage Capacities* litres (cu.ft.)	
Rear seats up (under luggage compartment cover)	410 (14.5)
Rear seats up with optional sliding rear seats in forward-most position	520 (18.4)
Rear seats folded (to upper edge of front seat back)	810 (28.6)
Rear seats folded (to roof)	1255 (44.3)

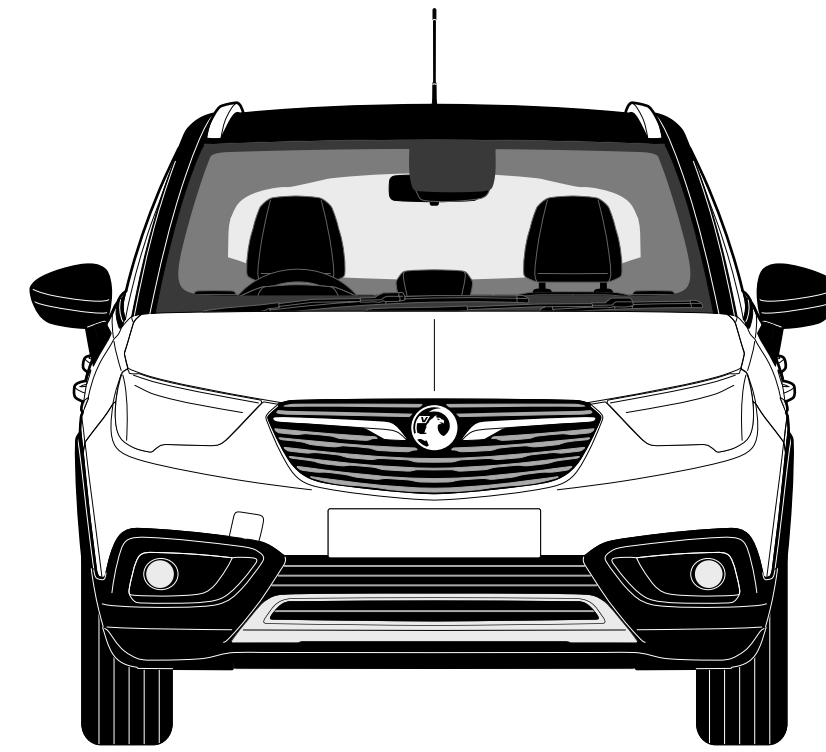

1765 (69.5)
excluding door mirrors

1976 (77.8)
including door mirrors

1605
(63.2)
including
roof rails

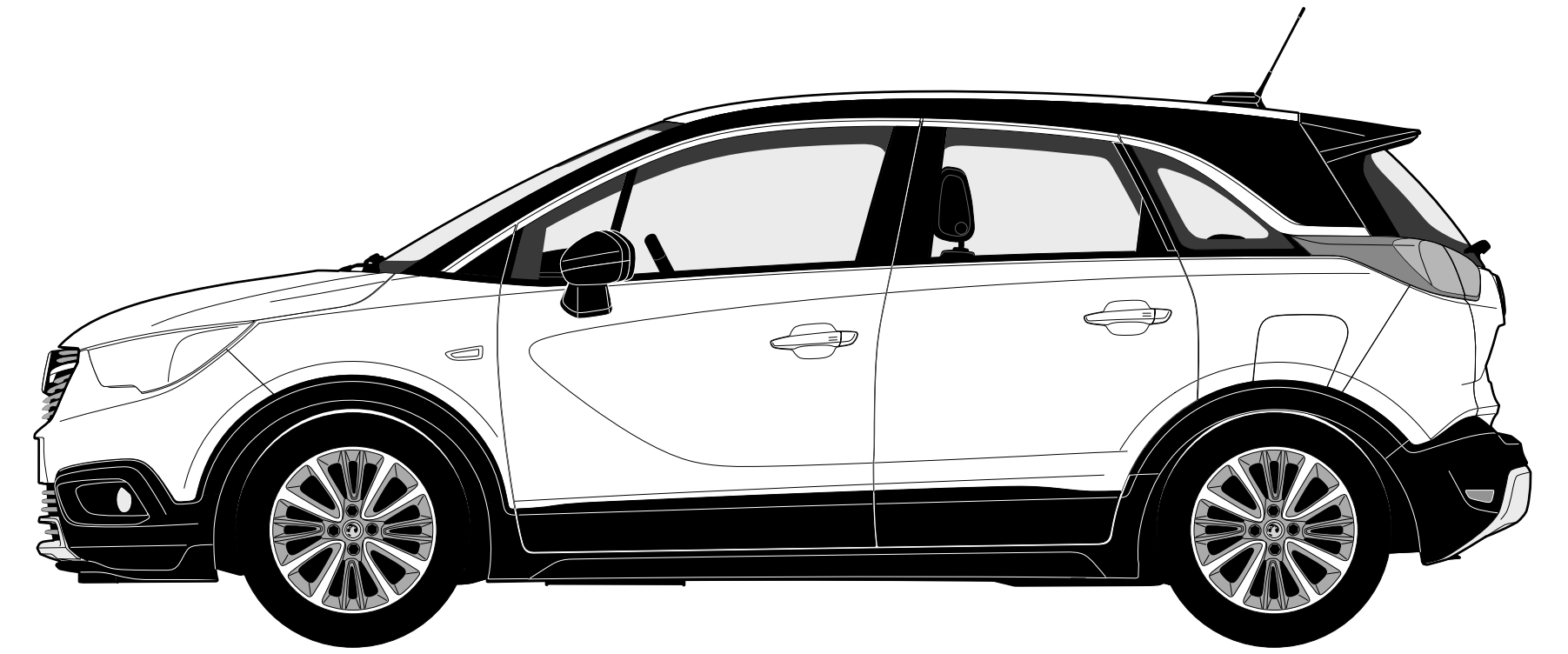

896
(35.3)

2604 (102.5)

712
(28.0)

4212 (165.8)

CROSSLAND X

All measurements are in mm (inches) unless stated otherwise.

*Measured using the ECIE method.

SPECIFICATIONS

Transmission

Five-speed manual gearbox:

Petrol engines: 1.2 (83PS)

Six-speed manual gearbox:

Petrol engines: 1.2 (110/130PS) Turbo models

Diesel engines: 1.5 (102PS) Turbo D models

Six-speed automatic transmission:

Petrol engines: 1.2 (110PS) Turbo models

Steering

- Speed-sensitive electric power-assisted steering
- Turning circle (wall-to-wall): 11.21m (36.7ft)

Suspension

Front: Independent. Decoupled MacPherson struts with gas-pressure dampers and coil springs. Anti-roll bar.

Rear: Compound crank with coil springs and gas-pressure dampers.

Braking and stability

- Switchable Electronic Stability Programme (ESP)
- Anti-lock Braking System (ABS)
- Corner stability control
- Traction control
- Hill start assist
- Engine drag torque control
- Hydraulic brake assist
- Hydraulic brake boost
- Electronic brakeforce distribution

1.2 (81PS)/1.5 (102PS) Turbo D models

Front ventilated discs: 266mm diameter

Rear discs: 249mm diameter

1.2 (110PS) Turbo ecoTEC/1.2 (130PS) Turbo

Front ventilated discs: 283mm diameter

Rear discs: 249mm diameter

Fuel tank capacity

- 45 litres (9.9 gallons)

Adblue tank capacity

- 15 litres (3.3 gallons)

Body

- Aerodynamic drag co-efficient: Cd 0.31

Start/stop technology

Crossland X's Start/Stop system, fitted as standard to all models except 1.2 (83PS), offers real benefits by improving fuel economy and reducing CO₂ emissions, particularly in town. It does this by automatically stopping the engine when you come to a standstill, and then restarting as you prepare to move off.

Before automatically stopping the engine a number of system checks are carried out to ensure that it is both safe and practical to do so. To ensure safety, the driver must depress the clutch pedal, shift in to neutral, and then release the clutch pedal. System checks carried out before Auto Stop activates include:

- Start/Stop system is not manually deactivated via the facia button
- Sufficient brake vacuum is available to prevent the car rolling down an incline
- Battery is in good condition and charged
- Outside air temperature and engine temperature are above specified minima
- Electronic climate control (where fitted) is not in maximum heating or maximum cooling mode
- Self-cleaning function of the diesel particulate filter is not active

If all of these conditions are satisfied then the vehicle will Auto Stop.

When you are ready to pull away from standstill, Auto Restart is activated by depressing the clutch pedal.

Whilst at a standstill the vehicle is continually monitored. If necessary, the engine will automatically be restarted. Conditions that would initiate an Auto Restart include:

- Low battery level
- Brake vacuum below specified minimum
- Start/Stop system is manually deactivated
- Stationary for 5.5 minutes

Weights and Towing Data kg

	Gross vehicle weight	Maximum towing weights Trailer with brakes (without brakes)
1.2 (83PS)	1690	650 (560)
1.2 (110PS) Turbo Start/Stop ecoTEC	1770	840 (600)
1.2 (110PS) Turbo Start/Stop auto	1805	840 (600)
1.2 (130PS) Turbo Start/Stop	1790	840 (620)
1.5 (102PS) Turbo D Start/Stop ecoTEC	1820	840 (620)

Gross vehicle weight is the total permissible weight of the vehicle including passengers and their luggage. The **maximum roof rack loading** should not exceed 75kg on all models. The **maximum towing weights** are based on the ability of the car, with two occupants of 75kg each, to restart on a 12% gradient, which is approximately 1 in 8.3, at sea level. The permitted trailer load applies up to the specified incline and up to an altitude of 1000 metres above sea level. The permissible gross train weight decreases by 10% for every 1000 metres of additional altitude. Any extra weight, such as luggage or additional passengers, should be deducted from the maximum towing weight. With a trailer fully loaded, **maximum noseweight** should not exceed 75kg. Always fit Vauxhall towing attachments and accessories available from your Vauxhall Retailer. They are designed specifically for Vauxhall models and carry a 12-month guarantee. During trailer towing do not exceed a maximum speed of 60mph. This speed limit is also applicable in countries with higher permitted speeds for trailer-vehicle combinations. Pay attention to the local speed limits. For trailers with low driving stability and caravans the use of an oscillation damper is strongly recommended.

PETROL ENGINES

Engine	1.2 (83PS)	1.2 (110PS) Turbo ecoTEC	1.2 (130PS) Turbo
Capacity	1199cc	1199cc	1199cc
Maximum power	83PS (61kW) @ 5750rpm	110PS (81kW) @ 5500rpm	130PS (96kW) @ 5500rpm
Maximum torque	118Nm (87 lb.ft.) @ 2750rpm	205Nm (151 lb.ft.) @ 1500rpm	230Nm (169 lb.ft.) @ 1750rpm
Configuration	3 cylinders, 4 valves per cylinder, double overhead camshafts	3 cylinders, 4 valves per cylinder, double overhead camshafts	3 cylinders, 4 valves per cylinder, double overhead camshafts
Fuel/induction system	Naturally aspirated with Variable Valve Timing. Multi-point sequential electronic fuel injection	Turbocharger. Variable Valve Timing. Direct fuel injection	Turbocharger. Variable Valve Timing. Direct fuel injection
Emission compliance	Euro 6.d-TEMP (6.2).	Euro 6.d FINAL (6.3). Gasoline Particulate Filter	Euro 6.d-TEMP (6.2). Gasoline Particulate Filter
Service interval	16,000 miles or 1 year (whichever occurs sooner)	16,000 miles or 1 year (whichever occurs sooner)	16,000 miles or 1 year (whichever occurs sooner)

DIESEL ENGINE

Engine	1.5 Turbo (102PS) Turbo D ecoTEC
Capacity	1499cc
Maximum power	102PS (75kW) @ 3500rpm
Maximum torque	250Nm (184 lb.ft.) @ 1750rpm
Configuration	4 cylinders, 4 valves per cylinder, double overhead camshafts
Fuel/induction system	Turbocharger. Direct fuel injection
Emission compliance	Euro 6.d - TEMP (6.2). Diesel Particulate Filter
Service interval	16,000 miles or 1 year (whichever occurs sooner)

ACCESSORIES

CHILD SEATS¹ Total (inc. VAT)

BABY-SAFE ² – 0-13kg/birth to 15 months	£141
– ISOFIX base	£244
DUO ISOFIX ² – 9-18kg/9 months to 4 years	
with top tether kit	£372
KID ² – 15-36kg or 4 to 12 years	£168

SAFETY

Parking sensors	
– four fully flush rear bumper mounted sensors	£336
– four fully flush front bumper mounted sensors ³	£317
Safety Pack – first aid kit, hi-visibility vest and small warning triangle	£30
Warning triangle – Small	£12
Warning triangle – Large	£20
First aid kit	£15
Hi-visibility vest	£9
Fire extinguisher – 2kg	£39

FLEXCONNECT RANGE

FlexConnect bracket	£22
FlexConnect hook	£32
FlexConnect coat hanger	£34
FlexConnect folding table	£77
FlexConnect iPad Mini cradle	£109
FlexConnect iPad (1-4) cradle	£118
FlexConnect iPad Air cradle	£117
FlexConnect Samsung Galaxy cradle	£107

PRACTICAL Total (inc. VAT)

Spare bulb kit ⁴	£39
Stretch tow rope – 3 tonne	£36
Smoker pack	£44
Privacy shades – rear and rear side windows	£104
Side steps	£521

PROTECTION

Rubber floor mats – set of four	£60
Velour floor mats – set of four	£58
Economy froot mats - set of four	£46
Cargo liner ⁵	£72
Cargo restraint kit	£276
Dog guard	£184
Mudflaps – front and rear	£112
Load compartment mat	£54

TRANSPORT SYSTEMS Total (inc. VAT)

Roof base carrier	from £197
Roof carriers (requires base carrier)	
Bike roof carrier – Thule Freeride 532	£78
Surf board roof carrier – Thule 833	£82
Kayak roof carrier – Thule 837	£172
Ski roof carrier (up to 4 pairs)	
– Thule 7324	£161
Ski roof carrier (up to 6 pairs)	
– Thule 7326	£190
Hard shell roof boxes (requires base carrier)	
Thule Ocean 80 (320 litre/1330 x 860 x 370mm)	£154
Thule Ocean 200 (450 litre/1750 x 820 x 450mm)	£323
Thule Motion 800 (460 litre/2050 x 840 x 450mm)	from £463
Thule Touring 200 (400 litre/1750 x 820 x 450mm)	£338
Thule Touring 700 (430 litre/2320 x 700 x 420mm)	£384
Tow bar carrier system	
Fixed tow bar ⁶	from £508
Detachable tow bar ⁶	from £673

STYLING Total (inc. VAT)

Door sill plates	£40
Illuminated door sill plates	£151
Stainless steel pedal covers	
– manual	£118
– automatic	£118

Please note: Prices shown are fully fitted and painted, where applicable and include VAT. Please check with your local Vauxhall Retailer for details. It is advisable to ensure your insurance policy is adequate to cover additional fitted accessories. Prices correct at time of publication.

¹Restrictions apply to the use of child seats, please consult your Vauxhall Retailer or request a copy of the Child seats brochure. ²Without transponder. ³Can only be fitted in conjunction with rear sensors. ⁴Excludes xenon headlight bulb for models with Adaptive Forward Lighting (AFL).

⁵For vehicles without spare wheel. ⁶Available with 7 pin, 13 pin and 12S electrics. Please consult your Vauxhall Retailer for details.

COMPANY CAR DRIVER AND FLEET INFORMATION

Design and Tech Line High Spec Low P11D

Specifically developed for businesses and company car drivers alike, our Design and Tech Line Nav models are seriously fit for Fleet.

Design models all feature very low P11D values, generous standard specification, including Sat Nav on Design Nav models, and a choice of high tech ecoTEC engines for great fuel economy and low emissions.

For even more standard specification, step up to our Tech Line Nav range. Again you are guaranteed low P11D values, plus great standard kit including Sat Nav, Bluetooth®, USB connection, aux-in socket and digital radio.

With Design and Tech Line Nav you can take for granted low Whole Life Costs and low company car driver taxation.

Company Car Driver Free 3 Day Test Drive

Our free* 3 Day Test Drive programme is open to all Company Car Drivers which allows you to choose any model in the current Vauxhall line-up (exclusions apply). With full insurance cover provided, it gives you a meaningful length of time to make an informed decision about your next company car.

Search Vauxhall 3DTD to book your FREE* test drive or click the link the below:

[Vauxhall 3 Day Test Drive](#)

*The free 3 Day Test Drive programme is open to Company Car Drivers and Fleet Decision Makers. Available for UK Mainland only. Terms and conditions apply. Full terms and conditions can be found at vauxhallfleet.co.uk/testdrive/index/terms.

Benefit in kind company car taxation†

The car benefit charge will be the car's list price (including VAT, options and accessories fitted, delivery to Retailer and number plates, but excluding Vehicle Excise Duty and new vehicle first registration fee) multiplied by the percentage charge for the CO₂ emissions band in which the car falls (see table opposite). Multiply this figure by your personal income tax rate (20%^{††} for Basic Rate, 40%^{††} for Higher Rate) to calculate your annual benefit in kind tax liability.

Example:

Crossland X Tech Line Nav 1.5 (102PS) Turbo D Start/Stop ecoTEC (CO₂ emissions 107g/km)

On-the-road RRP	£19,915.00
Deduct: Vehicle Excise Duty	(£170.00)
New vehicle first registration fee	(£55.00)
Effective list price	£19,690.00
Add: Optional two-coat metallic paint	£575.00
List price for tax purposes (P11D value)	£20,265.00
Car benefit charge 2019-20 tax year (29%)	£5,877.00
Benefit in kind tax liability (2019-20 tax year)	
Basic Rate (20%) tax payer	£1,175.40
Higher Rate (40%) tax payer	£2,350.80

†Please note this Price Guide provides taxation information as a guide only. Vauxhall does not provide taxation guidance. Drivers should always take professional advice on their own tax position.

††Excludes residents of Scotland.

BIK FOR SCOTTISH RESIDENTS

Effective 6 April 2018 the Scottish Government have introduced their own BIK taxation structure. This only applies to Company Car Drivers that are Scottish taxpayers. HMRC will determine whether or not an individual is a Scottish taxpayer based on where their main place of residence is.

The BIK rates for Scotland are:

- Over £12,500-£14,549 Starter Rate 19%
- Over £14,549-£24,994 Basic Rate 20%
- Over £24,994-£43,430 Intermediate Rate 21%
- Over £43,430-£150,000 Higher Rate 41%
- Above £150,000 Top Rate 46%

Benefit in kind company car taxation table

CO ₂ emissions in grams per kilometre	Percentage of cars price to be taxed	
	Non-Diesel [#] 2019-20 tax year	Diesel ^{##} 2019-20 tax year
Up to 50	16	20
51-75	19	23
76-94	22	26
95-99	23	27
100-104	24	28
105-109	25	29
110-114	26	30
115-119	27	31
120-124	28	32
125-129	29	33
130-134	30	34
135-139	31	35
140-144	32	36
145-149	33	37
150-154	34	37
155-159	35	37
160-164	36	37
165-169	37	37
170-174	37	37
175-179	37	37
180 and above	37	37

[#]Also applies to diesel vehicles that meet the Real Driving Emissions Step 2 (RDE2). ^{##}Applies to vehicles that do not meet the Real Driving Emissions Step 2 (RDE2).

To calculate your own personal liability, search: **Vauxhall BiK**, or click the link below: [Vauxhall BiK Tool](#)

Fleet Toolbox

Discover the facts in our online Toolbox for both Company Car Drivers and Fleet Decision Makers. The Fleet Toolbox has a host of useful calculators, comparators, interactive listings and information.

Search Vauxhall Fleet Tools or click the link below: [Vauxhall Fleet Tool Box](#)

Contact Vauxhall Fleet

Please contact one of our dedicated sales teams who will be happy to help with your particular enquiry.

Company Car Drivers

Call: 0345 111 2020

Email: company-car@vauxhallinfo.co.uk

Telephone lines are open

- Monday to Friday 8:00am-9:00pm

- Saturday and Sunday 9:00am-6:00pm

Fleet Decision Makers

Depending on the size of your fleet of vehicles, we have a dedicated team to handle your enquiries. The lines are open Monday to Friday excluding Bank Holidays.

1-24 vehicles

Call: 0845 076 2254 (8:30am-5:00pm)

25+ vehicles

Call: 0330 587 8222 (8:30am-5:00pm)

Email: vauxhallfleet@vauxhall.co.uk

Special Vehicles (Police, Fire and Ambulance)

Call: 01582 409999 (8:30am-5:00pm)

Email: vauxhallspecialvehicles@vauxhall.co.uk

For more information visit www.vauxhall.co.uk/fleet

FURTHER INFORMATION

On-the-road prices

To eliminate uncertainty about hidden costs when buying a new car, Vauxhall publishes on-the-road recommended retail prices (RRP) and these are shown in the pricing tables within this price guide. These prices include VAT, number plates and delivery to Retailer of £700.00 (including £116.67 VAT), 12 months' Government Vehicle Excise Duty (see opposite for details) and the DVLA new vehicle first registration fee of £55.00.*

Please note: The on-the-road recommended retail price (RRP) does not include fuel supplied by the Retailer, motor insurance or any other goods or services supplied by agreement between the Retailer and the customer.

Price protection

Order a new Vauxhall for build in the current model year (as confirmed by your Retailer) for delivery no more than three months in advance and the price you are quoted is the price you pay. This is irrespective of any subsequent price rises between placing your order and delivery of your new car, but you must take delivery as soon as the car is available. Vauxhall Motors Limited is not liable for price adjustments caused by Government changes in the rate of VAT (currently 20%), Vehicle Excise Duty, DVLA new vehicle first registration fee or by any other applicable legislation or regulations.

Vauxhall Finance Leasing

Vauxhall Finance Leasing is a trading style of Vauxhall Finance plc. Working with the Vauxhall Retailer network we provide competitive car and van leasing solutions for business users and private individuals. We combine the support of a national contract with the convenience of a local contact.

For further information, please contact your local Vauxhall Retailer or visit www.vauxhall.co.uk/leasing

In the event of an accident

Vauxhall Accident Management helps keep you mobile following an accident. Benefits include vehicle recovery, Vauxhall-approved repairs and contacting your insurer. For more details, visit www.vauxhall.co.uk/AccidentManagement

Vehicle Excise Duty

The amount of Vehicle Excise Duty (road fund licence) payable on new cars varies depending on the level of carbon dioxide (CO₂) emissions produced by the vehicle. CO₂ emissions are measured in grams per kilometre (g/km) travelled and divided into 13 charging bands shown in the table opposite.

A 'first year rate' of Vehicle Excise Duty is payable on all new cars and in subsequent years the amount payable reverts to the 'standard rate'. From 1 April 2017 the breakpoints for each of these bands have been revised. Also, for vehicles with a list price over £40,000, including factory-fitted options, an additional £320 is payable for the first five years of standard rate payments.

Vehicle Excise Duty*

Band	CO ₂ emissions in grams per kilometre	First year rate		Standard rate
		Petrol [#]	Diesel [†]	
A	0	£0	£0	£0
B	1-50	£10	£25	£145
C	51-75	£25	£110	£145
D	76-90	£110	£130	£145
E	91-100	£130	£150	£145
F	101-110	£150	£170	£145
G	111-130	£170	£210	£145
H	131-150	£210	£530	£145
I	151-170	£530	£855	£145
J	171-190	£855	£1,280	£145
K	191-225	£1,280	£1,815	£145
L	226-255	£1,815	£2,135	£145
M	over 255	£2,135	£2,135	£145

*Correct at time of issue.

[#]Also applies to diesel vehicles that meet the Real Driving Emissions Step 2 (RDE2).

[†]Applies to vehicles that do not meet the Real Driving Emissions Step 2 (RDE2).

FURTHER INFORMATION

Customer Care Commitment

For added peace of mind, Vauxhall has an innovative Customer Care Commitment that offers the following:

- Three-year vehicle warranty consisting of a one-year/unlimited mileage manufacturer's warranty and a second and third year manufacturer's warranty with a 60,000 miles limitation
- Vauxhall Assistance for 12 months from first registration
- Six years' body panel anti-perforation warranty

Please note: Warranty is only available on vehicles sourced from Vauxhall Motors Limited. Terms and conditions apply – please see your Vauxhall Retailer for details.

Vauxhall Assistance

Vauxhall Assistance is provided automatically with every new Vauxhall for 12 months from first registration and covers everything from accident assistance, roadside recovery and 'at home' service to flat tyres. With Vauxhall Assistance help is literally just a free* phone call away, 24 hours a day, 365 days a year!

Protecting the environment

Vauxhall's commitment to the environment is demonstrated by our products' many environmental awards. For even more information on Vauxhall's efforts to achieve an environmentally sustainable future, and how to dispose of your end-of-life vehicle, see www.vauxhall.co.uk/recycling

Vauxhall Service Plan

- Fixed monthly payments for the plan duration
- Easy to budget and interest-free
- Genuine parts fitted by Vauxhall-trained technicians

Plus on Gold plans:

- Valet and courtesy car
- Vauxhall Roadside Assistance
- Engine flush and fuel treatments
- Litre of oil for top ups between services

Full details can be obtained from your local participating Vauxhall Retailer.

Vauxhall Insurance with added reassurance

Comprehensive cover – Summary of benefits**

- Competitive premiums
- Repairs by a Vauxhall-trained technician
- Genuine Vauxhall parts, guaranteed for three years when we repair your car within our Approved Repairer Network
- Free courtesy car as standard when using an Approved Repairer†
- 24 hour claims helpline
- Personal Accident benefit
- Cover for audio equipment
- Windscreen cover

Call for a quote on **0844 463 2670**††

For more product information

For further information on the Vauxhall range or location of your nearest Vauxhall Retailer please call **0345 600 1500**. Alternatively, details can be found on our website at www.vauxhall.co.uk

*Mobile phone users will be charged at their standard tariff.

**The benefits listed above are for comprehensive cover only. For details of Third Party, Fire and Theft cover, please call our sales team.

†Should your car need repairing following an accident we provide a courtesy car (subject to availability) for the duration of the repair. Only genuine Vauxhall parts are used. Terms and conditions apply.

††Calls may be recorded. Vauxhall Insurance is underwritten by Ageas Insurance Limited.

Take the next step:



Join us online:

Discover the full Vauxhall range at [vauxhall.co.uk](https://www.vauxhall.co.uk) >

Privacy Policy: For full details please visit [vauxhall.co.uk/privacy](https://www.vauxhall.co.uk/privacy)

The invoice price, including delivery to Retailer, factory-fitted options, accessories fitted by the Retailer and number plates, is subject to VAT. Some feature descriptions in this guide may refer to, and some illustrations may show, optional equipment not included in the standard delivery. The information contained in this guide was accurate at the time of publication. We reserve the right to make changes in design and equipment. Please note that Vauxhall Retailers are not the agents of Vauxhall Motors Limited and are not authorised to bind Vauxhall Motors Limited by any specific or implied undertaking or representation. It is advisable to ensure that your motor insurance policy provides adequate cover for additional fitted options and accessories. The colours in this guide are only approximate actual colours. Illustrated optional equipment is available at extra charge. Availability, technical features and equipment provided on our vehicles can vary by model. For precise information on the equipment provided on our vehicles, please contact your local Vauxhall Retailer.

MOKKA X

PRICE/SPECIFICATION GUIDE

1 April 2019 | Model Year 2019.5





VAUXHALL



British Brand since 1903

MOKKA X RANGE HIGHLIGHTS



ACTIVE	OTR from £22,645
<i>Standard features include:</i>	
Infotainment:	
<ul style="list-style-type: none"> • R4.0 IntelliLink system <ul style="list-style-type: none"> – Smartphone projection, Apple CarPlay™ and Android Auto™ – 7-inch colour touchscreen – AM/FM/digital radio – Bluetooth® audio streaming – Bluetooth® mobile phone portal – USB connection with iPod control – Aux-in socket 	
Interior convenience / styling:	
<ul style="list-style-type: none"> • Dual-zone electronic climate control • Cruise control with speed limiter • Leather-covered steering wheel • Steering column adjustable for reach and rake • Steering wheel mounted audio controls 	
Exterior convenience / styling:	
<ul style="list-style-type: none"> • Silver-effect 17-inch alloy wheels • Silver-effect roof rails • Alloy-effect protective front skid plate • Front fog lights 	
Safety / security:	
<ul style="list-style-type: none"> • Switchable electronic stability programme • Anti-lock braking system • Traction control • Hill start assist • LED daytime running lights • Remote control security alarm system 	
	17-inch 

DESIGN NAV	OTR from £20,645
<i>Features over Active:</i>	
Infotainment:	
<ul style="list-style-type: none"> • Navi 900 IntelliLink system <ul style="list-style-type: none"> – Fully integrated European satellite navigation system – Smartphone projection, Apple CarPlay™ and Android Auto™ – 8-inch colour touchscreen – AM/FM/digital radio – Bluetooth® mobile streaming – Bluetooth® mobile phone portal – USB connection with iPod control – Aux-in socket 	
	17-inch 

GRIFFIN/GRIFFIN PLUS PRICE AVAILABLE ON REQUEST FROM RETAILER
<i>Features over Active:</i>
Infotainment:
<ul style="list-style-type: none"> • Navi 900 IntelliLink system <ul style="list-style-type: none"> – Fully integrated European satellite navigation system – Smartphone projection, Apple CarPlay™ and Android Auto™ – 8-inch colour touchscreen – AM/FM/digital radio – Bluetooth® mobile streaming – Bluetooth® mobile phone portal – USB connection with iPod control – Aux-in socket
Interior convenience / styling:
<ul style="list-style-type: none"> • Premium leather-effect / fabric seat trim • Heated leather-covered steering wheel • Ergonomic active front seats • Heated front seats • Auto anti-dazzle rear-view mirror • Front and rear floor mats (front Griffin-branded)
Exterior convenience / styling:
<ul style="list-style-type: none"> • Rain-sensitive windscreen wipers • High beam assist • Chrome-effect side window trim • Brilliant, metallic or premium paint – available at no additional cost • 18-inch 10-spoke alloy wheels – Griffin models • 19-inch 5-twin spoke alloy wheels – Griffin Plus models
Colours and model variants for Griffin special edition subject to availability. Please check with your Vauxhall Retailer.
18-inch 
19-inch 

Please note, Mokka X model and option availability is restricted. Please check with your Vauxhall Retailer.

MOKKA X RANGE HIGHLIGHTS



ACTIVE	OTR from £22,645
<p><i>Standard features include:</i></p> <p>Infotainment:</p> <ul style="list-style-type: none"> • R4.0 IntelliLink system <ul style="list-style-type: none"> – Smartphone projection, Apple CarPlay™ and Android Auto™ – 7-inch colour touchscreen – AM/FM/digital radio – Bluetooth® audio streaming – Bluetooth® mobile phone portal – USB connection with iPod control – Aux-in socket <p>Interior convenience / styling:</p> <ul style="list-style-type: none"> • Dual-zone electronic climate control • Cruise control with speed limiter • Leather-covered steering wheel • Steering column adjustable for reach and rake • Steering wheel mounted audio controls <p>Exterior convenience / styling:</p> <ul style="list-style-type: none"> • Silver-effect 17-inch alloy wheels • Silver-effect roof rails • Alloy-effect protective front skid plate • Front fog lights <p>Safety / security:</p> <ul style="list-style-type: none"> • Switchable electronic stability programme • Anti-lock braking system • Traction control • Hill start assist • LED daytime running lights • Remote control security alarm system 	
	<p>17-inch</p> 

ELITE	OTR from £25,145
<p><i>Features over Active:</i></p> <p>Interior convenience / styling:</p> <ul style="list-style-type: none"> • Leather seat facings • Ergonomic sports front seats • Electrically heated front seats • Electrically heated steering wheel • Rear seat centre armrest with drinks holders <p>Exterior convenience / styling:</p> <ul style="list-style-type: none"> • Chrome-effect side window trim <p>4X4 models additionally feature:</p> <ul style="list-style-type: none"> • Intelligent four-wheel drive • Descent control system 	
ELITE NAV	OTR from £25,845
<p>Elite Nav models additional feature:</p> <ul style="list-style-type: none"> • Navi 900 IntelliLink system <ul style="list-style-type: none"> – Fully integrated European satellite navigation system – 8-inch colour touchscreen 	
	<p>17-inch</p> 

Please note, Mokka X model and option availability is restricted. Please check with your Vauxhall Retailer.





MOKKA X ACTIVE

5-door SUV
OTR RRP CO₂ (g/km)

ACTIVE – ON-THE-ROAD PRICES

Petrol	1.4i Turbo (140PS) Start/Stop ecoTEC FWD	£22,645	147
	1.4i Turbo (140PS) auto FWD	£23,875	157
Diesel	1.6CDTi (136PS) Start/Stop ecoTEC BlueInjection FWD	£24,325	127

Please note: On-the-road recommended retail prices (RRP) include VAT at 20%, number plates and delivery to Retailer of £700.00 (inc. £116.67 VAT), 12 months' Vehicle Excise Duty and new vehicle first registration fee of £55.00. Excludes fuel and insurance.

KEY OPTIONS		Total inc. VAT
 Looking good:	Brilliant paint	£285
	Metallic paint	£575
	Two-coat premium paint	£655
	Tri-coat premium paint	£725
	19-inch 5-twinspoke alloy wheels	£610
 Sitting comfortably:	Winter Pack	£280
 Fresh air:	Power tilt and slide glass sunroof with manually operated sunblind	£505
 Driving assistance:	Premium LED Adaptive Forward Lighting (AFL) <i>Six LED elements light the road 30% brighter than halogen, allowing you to see hazards sooner and giving you more time to react. The AFL system uses data such as vehicle speed, steering angle and when the indicators are used to determine the most suitable lighting.</i>	£1160
 Practicality:	Steel emergency spare wheel (in lieu of emergency tyre inflation kit)	£110
	Navi 900 IntelliLink system touchscreen navigation and infotainment system	£710

For details of these and other options please see Features / Options pages.



FEATURES

Infotainment:

- R4.0 IntelliLink system
 - Smartphone projection, Apple CarPlay™ and Android Auto™
 - 7-inch colour touchscreen
 - AM/FM/digital radio
 - Bluetooth® audio streaming
 - Bluetooth® mobile phone portal
 - USB connection with iPod control
 - Aux-in socket

Interior convenience / styling:

- Dual-zone electronic climate control
- Cruise control with speed limiter
- Multi-function trip computer
- Leather-covered steering wheel
- Steering column adjustable for reach and rake
- Steering wheel mounted audio controls
- 60/40 split flip and fold rear seat
- Front driver's armrest

Exterior convenience / styling:

- Silver-effect 17-inch alloy wheels
- Alloy-effect protective front skid plate
- Side-protection mouldings
- Silver-effect roof rails
- Front fog lights
- Electrically adjustable/heated door mirrors
- Electrically operated front and rear windows
- Remote control central locking
- Stainless steel exhaust tailpipe

Safety / security:

- Switchable electronic stability programme
- Anti-lock braking system
- Traction control
- Hill start assist
- Tyre pressure monitoring system
- Six airbags
- Remote control alarm system
- Emergency tyre inflation kit in lieu of spare wheel
- LED daytime running lights

COMPANY CAR INFORMATION

-  P11D price starting at £22,380
-  From 33% tax band*
-  From £123 monthly BiK tax*
-  CO₂ emissions from 127g/km

Please see www.vauxhall.co.uk/fleet for details.

* = 2019/20 tax year.





MOKKA X DESIGN NAV

5-door SUV
OTR RRP CO₂ (g/km)

DESIGN NAV – ON-THE-ROAD PRICES

<i>Petrol</i>	1.4i Turbo (140PS) Start/Stop ecoTEC FWD	£20,645	147
	1.4i Turbo (140PS) auto FWD	£21,875	157
<i>Diesel</i>	1.6CDTi (136PS) Start/Stop ecoTEC BlueInjection FWD	£22,325	127

Please note: On-the-road recommended retail prices (RRP) include VAT at 20%, number plates and delivery to Retailer of £700.00 (inc. £116.67 VAT), 12 months' Vehicle Excise Duty and new vehicle first registration fee of £55.00. Excludes fuel and insurance.

KEY OPTIONS		Total inc. VAT
 Looking good:	Brilliant paint	£285
	Metallic paint	£575
	Two-coat premium paint	£655
	Tri-coat premium paint	£725
	19-inch 5-twinspoke alloy wheels	£610
 Sitting comfortably:	Winter Pack	£280
 Fresh air:	Power tilt and slide glass sunroof with manually operated sunblind	£505
 Driving assistance:	Premium LED Adaptive Forward Lighting (AFL) <i>Six LED elements light the road 30% brighter than halogen, allowing you to see hazards sooner and giving you more time to react. The AFL system uses data such as vehicle speed, steering angle and when the indicators are used to determine the most suitable lighting.</i>	£1160
 Practicality:	Steel emergency spare wheel (in lieu of emergency tyre inflation kit)	£110

For details of these and other options please see Features / Options pages.



FEATURES

Infotainment:

- Navi 900 IntelliLink system
 - Fully integrated European satellite navigation system
 - Smartphone projection, Apple CarPlay™ and Android Auto™
 - 8-inch colour touchscreen
 - AM/FM/digital radio
 - Bluetooth® audio streaming
 - Bluetooth® mobile phone portal
 - USB connection with iPod control
 - Aux-in socket

Interior convenience / styling:

- Dual-zone electronic climate control
- Cruise control with speed limiter
- Multi-function trip computer
- Leather-covered steering wheel
- Steering column adjustable for reach and rake
- Steering wheel mounted audio controls
- 60/40 split flip and fold rear seat
- Front driver's armrest

Exterior convenience / styling:

- Silver-effect 17-inch alloy wheels
- Alloy-effect protective front skid plate
- Side-protection mouldings
- Silver-effect roof rails
- Front fog lights
- Electrically adjustable/heated door mirrors
- Electrically operated front and rear windows
- Remote control central locking
- Stainless steel exhaust tailpipe

Safety / security:

- Switchable electronic stability programme
- Anti-lock braking system
- Traction control
- Hill start assist
- Tyre pressure monitoring system
- Six airbags
- Remote control alarm system
- Emergency tyre inflation kit in lieu of spare wheel
- LED daytime running lights

COMPANY CAR INFORMATION

-  P11D price starting at £20,380
-  From 33% tax band*
-  From £112 monthly BiK tax*
-  CO₂ emissions from 127g/km

Please see www.vauxhall.co.uk/fleet for details.

* = 2019/20 tax year.

GRIFFIN/GRIFFIN PLUS

5-door SUV
CO₂ (g/km)

GRIFFIN – PRICE AVAILABLE ON REQUEST FROM RETAILER

<i>Petrol</i>	1.4i Turbo (140PS) Start/Stop ecoTEC FWD	150
	1.4i Turbo (140PS) auto FWD	162

<i>Diesel</i>	1.6CDTi (136PS) Start/Stop ecoTEC BlueInjection FWD	131
---------------	---	-----

GRIFFIN PLUS – PRICE AVAILABLE ON REQUEST FROM RETAILER

<i>Petrol</i>	1.4i Turbo (140PS) Start/Stop ecoTEC FWD	150
	1.4i Turbo (140PS) auto FWD	162

<i>Diesel</i>	1.6CDTi (136PS) Start/Stop ecoTEC BlueInjection FWD	131
---------------	---	-----

Please note: On-the-road recommended retail prices (RRP) include VAT at 20%, number plates and delivery to Retailer of £700.00 (inc. £116.67 VAT), 12 months' Vehicle Excise Duty and new vehicle first registration fee of £55.00. Excludes fuel and insurance.

Colours and model variants for Griffin special edition subject to availability. Please check with your Vauxhall Retailer.



FEATURES

Infotainment:

- Navi 900 IntelliLink system
 - Fully integrated European satellite navigation system
 - Smartphone projection, Apple CarPlay™ and Android Auto™
 - 8-inch colour touchscreen
 - AM/FM/digital radio
 - Bluetooth® mobile streaming
 - Bluetooth® mobile phone portal
 - USB connection with iPod control
 - Aux-in socket

Interior convenience / styling:

- Premium leather-effect / fabric seat trim
- Dual-zone electronic climate control
- Cruise control with speed limiter
- Multi-function trip computer
- Heated leather-covered steering wheel
- Ergonomic active front seats
- Heated front seats
- Auto anti-dazzle rear-view mirror
- Steering column adjustable for reach and rake
- Steering wheel mounted audio controls
- 60/40 split flip and fold rear seat
- Front driver's armrest
- Front and rear floor mats (front Griffin-branded)

Exterior convenience / styling:

- Rain-sensitive windscreen wipers
- High beam assist
- Front fog lights
- Electrically adjustable/heated door mirrors
- Electrically operated front and rear windows
- Remote control central locking
- Alloy-effect protective front skid plate
- Silver-effect roof rails
- Stainless steel exhaust tailpipe
- Chrome-effect side window trim
- Brilliant, metallic or premium paint – available at no additional cost
- 18-inch 10-spoke alloy wheels – Griffin models
- 19-inch 5-twinspoke alloy wheels – Griffin Plus models

Safety / security:

- Switchable electronic stability programme
- Anti-lock braking system
- Traction control
- Hill start assist
- Tyre pressure monitoring system
- Six airbags
- Remote control alarm system
- Emergency tyre inflation kit in lieu of spare wheel
- LED daytime running lights







19-inch wheel standard on Plus models.

MOKKA X ELITE

		5-door SUV	
		OTR RRP	CO ₂ (g/km)
ELITE – ON-THE-ROAD PRICES			
Petrol	1.4i Turbo (140PS) Start/Stop ecoTEC FWD	£25,145	147
	1.4i Turbo (140PS) auto FWD	£26,375	157
	1.4i Turbo (140PS) Start/Stop 4X4	£27,145	162
Diesel	1.6CDTi (136PS) Start/Stop ecoTEC BlueInjection FWD	£26,825	127

		5-door SUV	
		OTR RRP	CO ₂ (g/km)
ELITE NAV – ON-THE-ROAD PRICES			
Petrol	1.4i Turbo (140PS) Start/Stop ecoTEC FWD	£25,845	147
	1.4i Turbo (140PS) auto FWD	£27,075	157
	1.4i Turbo (140PS) Start/Stop 4X4	£27,845	162
Diesel	1.6CDTi (136PS) Start/Stop ecoTEC BlueInjection FWD	£27,525	127

Please note: On-the-road recommended retail prices (RRP) include VAT at 20%, number plates and delivery to Retailer of £700.00 (inc. £116.67 VAT), 12 months' Vehicle Excise Duty and new vehicle first registration fee of £55.00. Excludes fuel and insurance.

KEY OPTIONS		Total inc. VAT
 Looking good:	Brilliant paint	£285
	Metallic paint	£575
	Two-coat premium paint	£655
	Tri-coat premium paint	£725
	18-inch diamond-cut bi-colour 10-spoke alloy wheels	£385
	19-inch 5-twin-spoke alloy wheels	£610
 Fresh air:	Power tilt and slide glass sunroof with manually operated sunblind	£505
 Driving assistance:	Premium LED Adaptive Forward Lighting (AFL) <i>Six LED elements light the road 30% brighter than halogen, allowing you to see hazards sooner and giving you more time to react. The AFL system uses data such as vehicle speed, steering angle and when the indicators are used to determine the most suitable lighting.</i>	£1160
 Practicality:	Steel emergency spare wheel (in lieu of emergency tyre inflation kit)	£110

For details of these and other options please see Features / Options pages.



FEATURES

Infotainment:

- R 4.0 IntelliLink system
 - Smartphone projection, Apple CarPlay™ and Android Auto™
 - 7-inch colour touchscreen
 - AM/FM/digital radio
 - Bluetooth® audio streaming
 - Bluetooth® mobile phone portal
 - USB connection with iPod control
 - Aux-in socket

Interior convenience / styling:

- Leather seat facings
- Ergonomic heated active front seats
- Electrically heated steering wheel
- Dual-zone electronic climate control
- Cruise control / trip computer
- Leather-covered steering wheel
- Steering column adjustable for reach and rake
- Steering wheel mounted audio controls
- Auto anti-dazzle rear-view mirror
- Front driver's armrest

Exterior convenience / styling:

- Silver-effect 17-inch alloy wheels
- Alloy-effect protective front skid plate
- Side-protective mouldings
- Front fog lights
- Electrically adjustable/heated door mirrors
- Electrically operated front / rear windows
- Remote control central locking
- Stainless steel exhaust tailpipe
- Chrome-effect side window trim
- High beam assist
- Auto lighting / windscreen wipers

Safety / security:

- Switchable electronic stability programme
- Anti-lock braking system
- Hill start assist
- Tyre pressure monitoring system
- Six airbags
- Remote control alarm system
- Emergency tyre inflation kit in lieu of spare wheel
- LED daytime running lights

4X4 models additionally feature:

- Intelligent four-wheel drive
- Descent control system

Elite Nav models additionally feature:

- Navi 900 IntelliLink system
 - Fully integrated European satellite navigation system
 - 8-inch colour touchscreen

COMPANY CAR INFORMATION

-  P11D price starting at £24,880
-  From 33% tax band*
-  From £137 monthly BiK tax*
-  CO₂ emissions from 127g/km

Please see www.vauxhall.co.uk/fleet for details.

* = 2019/20 tax year.

MOKKA X PRICES

Model 5-door SUV	Price (£)	VAT (£)	Total (£)	On-the-road RRP (£)	BiK 20% (£)	CO ₂ (g/km)
ACTIVE						
1.4i Turbo (140PS) S/S ecoTEC FWD	18066.67	3613.33	21680.00	22645.00	123.08	147
1.4i Turbo (140PS) auto FWD	18825.00	3765.00	22590.00	23875.00	135.85	157
<i>Diesel</i>						
1.6CDTi (136PS) S/S ecoTEC BlueInjection* FWD	19466.67	3893.33	23360.00	24325.00	132.32	127
DESIGN NAV						
1.4i Turbo (140PS) S/S ecoTEC FWD	16400.00	3280.00	19680.00	20645.00	112.08	147
1.4i Turbo (140PS) auto FWD	17158.33	3431.67	20590.00	21875.00	124.18	157
<i>Diesel</i>						
1.6CDTi (136PS) S/S ecoTEC BlueInjection* FWD	17800.00	3560.00	21360.00	22325.00	121.32	127
GRIFFIN (SPECIAL EDITION MODEL)						
1.4i Turbo (140PS) S/S ecoTEC FWD						150
1.4i Turbo (140PS) auto FWD						162
<i>Diesel</i>						
1.6CDTi (136PS) S/S ecoTEC BlueInjection* FWD				PRICE AVAILABLE ON REQUEST FROM RETAILER		131
GRIFFIN PLUS (SPECIAL EDITION MODEL)						
1.4i Turbo (140PS) S/S ecoTEC FWD						150
1.4i Turbo (140PS) auto FWD						162
<i>Diesel</i>						
1.6CDTi (136PS) S/S ecoTEC BlueInjection* FWD				PRICE AVAILABLE ON REQUEST FROM RETAILER		131

Please note, Mokka X model and option availability is restricted. Please check with your Vauxhall Retailer.

Model 5-door SUV	Price (£)	VAT (£)	Total (£)	On-the-road RRP (£)	BiK 20% (£)	CO ₂ (g/km)
ELITE						
1.4i Turbo (140PS) S/S ecoTEC FWD	20150.00	4030.00	24180.00	25145.00	136.83	147
1.4i Turbo (140PS) auto FWD	20908.33	4181.67	25090.00	26375.00	150.43	157
1.4i Turbo (140PS) S/S 4X4	21550.00	4310.00	25860.00	27145.00	159.35	162
<i>Diesel</i>						
1.6CDTi (136PS) S/S ecoTEC BlueInjection* FWD	21550.00	4310.00	25860.00	26825.00	146.07	127
ELITE NAV						
1.4i Turbo (140PS) S/S ecoTEC FWD	20733.33	4146.67	24880.00	25845.00	140.68	147
1.4i Turbo (140PS) auto FWD	21491.67	4298.33	25790.00	27075.00	154.52	157
1.4i Turbo (140PS) S/S 4X4	22133.33	4426.67	26560.00	27845.00	163.55	162
<i>Diesel</i>						
1.6CDTi (136PS) S/S ecoTEC BlueInjection* FWD	22133.33	4426.67	26560.00	27525.00	149.92	127

Please note: On-the-road recommended retail prices (RRP) include number plates and delivery to retailer of £700.00 (inc. £116.67 VAT), 12 months' Vehicle Excise Duty and new vehicle first registration fee of £55.00. Excludes fuel and insurance. Company Car Benefit in Kind (BiK) rates are monthly based on the standard paint price.
S/S = Start/Stop.

* = Please note: Vehicles with BlueInjection technology will need regular AdBlue® top-ups also between servicing requirements. An indicator integrated into the on-board computer will warn you when you need to top up. More information under www.vauxhall.co.uk/discover-vauxhall/technology/adblue.html

MOKKA X FEATURES / OPTIONS

SAFETY

Driver / passenger airbags

- Driver's airbag • Front passenger's airbag • Front seat side-impact airbags
- Full-size curtain airbags for driver, front seat passenger and outer rear seat passengers

Seating

- Height-adjustable front seat head restraints • Height-adjustable outer rear seat head restraints

Seatbelts

- Height adjustable front inertia-reel lap and diagonal seatbelts • Three inertia-reel lap and diagonal rear seatbelts • Front body-lock diagonal seatbelt pretensioner system – *Tightens the seatbelt during the early stages of a frontal impact, limiting forward movement.* • Driver's and front passenger's lap belt pretensioner system • Front seatbelt force limiters – *Reduces potential upper body injuries during a frontal impact.* • Front and rear 'seatbelt unfastened' warning light

Child safety

- Deactivation switch for front passenger's front and side-impact airbags – *Permits the safe use of a child seat in the front passenger seat.* • ISOFIX child seat mountings incorporating top tether anchor points located on outer rear seats (does not include child seat) – *Allows ISOFIX child safety seats to be securely fixed into the car. The ISOFIX mounting system reduces forward movement in an accident and makes the child seat easier to install.*

Driver / passenger safety

- Energy-absorbing steering column • Pedal release system – *Reduces potential injury to the driver's legs and feet during a severe frontal impact.* • Laminated windscreen • Side-impact protection beams • Reinforced passenger safety cell • Deformation zones front and rear
- Burst-proof door locks and anti-jam door design

Pedestrian safety

- Collapsible windscreen wiper system – *Designed to reduce pedestrian head injuries.*
- Upper and lower bumper design – *Reduces upper and lower leg injuries.*

Stability

Switchable Electronic Stability Programme (ESP):

– Works in conjunction with the vehicle's electronic braking and engine systems to keep the car stable in many different situations. ESP monitors many different inputs to determine when the car starts to lose traction, it can then immediately respond by varying the brake pressure between up to three wheels and adjust the engine output to help correct the loss of traction and improve stability.

Additional ESP features:

- Cornering brake control • Straight line stability control
- Descent control system (4X4 models only) • Rollover mitigation
- Traction control

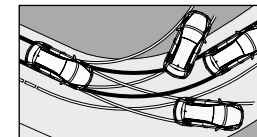

Braking

Anti-lock Braking System (ABS):

– Prevents the vehicle's wheels from locking up under heavy braking by momentarily reducing brake pressure at the appropriate wheel, ensuring that you can maintain control of the steering.

Additional braking features:

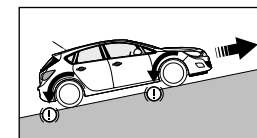

- The same electronic systems used in the ABS and ESP also deliver exceptional braking performance.
- Emergency brake assist – *When emergency braking is detected the vehicle automatically applies the maximum possible braking assistance.* • Electronic brakeforce distribution – *Automatically apportions the optimum braking force to each wheel.* • Adaptive brake lights – *Automatically warns other road users of heavy braking.* • Hill start assist – *Briefly maintains rear brake pressure to stop the vehicle rolling back on an incline.* • Hazard warning lights



Tyre pressure

- Tyre pressure monitoring system

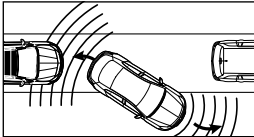
MOKKA X FEATURES / OPTIONS

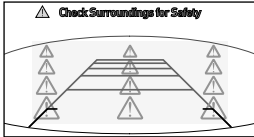
DRIVER ASSISTANCE		Active	Design Nav	Griffin / Griffin Plus	Elite	Price (£) exc. VAT	Total (£) inc. VAT
Steering	<ul style="list-style-type: none"> Speed-sensitive power-assisted steering 	●	●	●	●		
Cruise control with speed limiter	<p>The cruise control feature enables you to maintain a constant speed – making it ideal for economical motorway driving.</p> <p>The speed limiter function can be set to ensure that you do not exceed the speed limit and can be easily overridden if required.</p> <ul style="list-style-type: none"> Steering wheel mounted controls 	●	●	●	●		
Electro Pack	<ul style="list-style-type: none"> Electrically foldable door mirrors 12-volt electrical accessory socket in rear of centre console Front and rear parking distance sensors <p> Easier parking</p>		○	○	○	483.33	580.00
Sight and Light Pack	<ul style="list-style-type: none"> Rain-sensitive windscreen wipers High beam assist Automatically dimming anti-dazzle rear-view mirror 	○	○	●	●	200.00	240.00
Rear-view camera (only available with Electro Pack)	<p>The rear-view camera gives a clear view of the area behind your car and helps place the car perfectly, without needing to strain your neck.</p> <ul style="list-style-type: none"> Activated when reverse gear selected Camera view appears in infotainment screen Rear bumper and one-metre grid lines shown as reference points. <p> See what's behind you on the central screen</p>		○	○	○	237.50	285.00

● = Standard equipment. ○ = Optional at extra cost.

MOKKA X FEATURES / OPTIONS

	Active	Design Nav	Griffin / Griffin Plus	Elite	Price (£) exc. VAT	Total (£) inc. VAT
SECURITY						
Standard security features • Electronically protected audio equipment • Engine deadlock immobiliser • Visible Vehicle Identification Number (VIN) • Locking wheel nuts • Foldable luggage area cover	●	●	●	●		
Remote control central locking • Operates on doors, tailgate and fuel filler flap • Deadlocking • Driver's internal central locking activation switch • One folding key/one static key each with integral remote control function	●	●	●	●		
Remote control security alarm system • Remote control (operates in conjunction with central locking)	●	●	●	●		
DRIVER INFORMATION						
Instrumentation • Speedometer • Rev counter • Fuel gauge with low fuel level warning light • Water temperature gauge with warning light • Shift-up indication light (manual models only) – <i>Indicates when to change gear for optimum fuel economy.</i>	●	●	●	●		
Driver information display (centrally located in instrument cluster) • Monochrome display • Displays trip computer data • Total mileage • Service due indicator • Oil life • Tyre pressure monitor system	●	●	●	●		
Driver information display with ecoTEC Drive Assist (Start/Stop models only): <i>Includes information on which electrical items are using the most energy, fuel consumption statistics for the last 30 miles and when to change gear to help maximise economy.</i>	●	●	●	●		
Multi-function trip computer (displayed on driver information display) • Trip mileage • Vehicle range based on remaining fuel • Average speed • Average fuel economy • Instantaneous fuel economy	●	●	●	●		
Central facia display (format dependent on infotainment unit) • Audio information • Digital clock with automatic RDS time adjustment • Outside air temperature with ice warning function • Additional features dependent on infotainment unit (see infotainment for details)	●	●	●	●		

● = Standard equipment.

MOKKA X FEATURES / OPTIONS

INTERIOR STYLING	Active	Design Nav	Griffin / Griffin Plus	Elite	Price (£) exc. VAT	Total (£) inc. VAT
Active interior décor Steering wheel: • Three-spoke design • Leather-covered • Satin chrome-effect bezel Facia and door trim: • Black facia • Black door panels with black Atlantis cloth inserts • Chrome-effect interior door handles Seat trim: • Milano fabric seat trim inserts • Plain black fabric side bolsters and surrounds	●					
Design Nav interior décor Steering wheel: • Three-spoke design • Leather-covered • Satin chrome-effect bezel Facia and door trim: • Black facia • Black door panels with black Atlantis cloth inserts • Chrome-effect interior door handles Seat trim: • Milano fabric seat trim inserts • Plain black fabric side bolsters and surrounds		●				
Griffin / Griffin Plus interior décor Steering wheel: • Three-spoke design • Leather-covered • Satin chrome-effect bezel Facia and door trim: • Black facia • Black door panels with black leather-effect inserts • Chrome-effect interior door handles Seat trim: • Rhombus cloth seat trim inserts • Premium leather-effect side bolsters and surrounds			●			
Elite interior décor with Black Jasmin leather seat trim Steering wheel: • Three-spoke design • Leather-covered • Satin chrome-effect bezel Facia and door trim: • Black facia • Black door panels with black leather-effect inserts • Chrome-effect interior door handles Seat trim: • Black Jasmin leather seat trim inserts • Black leather-effect side bolsters and surrounds				●		
Elite interior décor with Morello Red Jasmin leather seat trim (not available with Aegean Blue, Lava Red, Satin Steel Grey and Amber Orange exterior colours) Steering wheel: • Three-spoke design • Leather-covered • Satin chrome-effect bezel Facia and door trim: • Black facia • Black door panels with black leather-effect inserts • Chrome-effect interior door handles Seat trim: • Morello Red Jasmin leather seat trim inserts • Morello Red leather-effect side bolsters and surrounds				N/C	No-cost option	

● = Standard equipment. N/C = No-cost option.

MOKKA X FEATURES / OPTIONS

INFOTAINMENT	Active	Design Nav	Griffin / Griffin Plus	Elite	Price (£) exc. VAT	Total (£) inc. VAT
R4.0 IntelliLink system touchscreen infotainment system <i>For use with MP3 players, USB memory sticks, mobile phones and smartphone apps</i>						
Onboard features: • 7-inch colour touchscreen • Digital radio/AM/FM stereo radio with 36 station presets • RDS with Traffic Programme						
Media connections: • USB connection with iPod control • Aux-in socket • Bluetooth A2DP audio streaming (Advanced Audio Distribution Profile)	●			●		
Mobile phone portal: • Bluetooth® connectivity • Handfree calls via steering wheel controls • Vehicle microphone • Phone book access – <i>Contacts/last calls/missed calls etc. are mirrored on IntelliLink's display and are easily navigated using the touchscreen (features dependent on mobile phone)</i>						
Smartphone interface: • Apple CarPlay™ • Android Auto™						
Navi 900 IntelliLink system touchscreen navigation and infotainment system <i>For use with MP3 players, USB memory sticks, mobile phones and smartphone apps</i>						
Onboard features: • 8-inch colour touchscreen • Digital radio/AM/FM stereo radio with 36 station presets • RDS with Traffic Programme • 60 configurable favourites including contacts, addresses, playlists, radio stations and voice recognition						
Navigation features: • Satellite navigation system • 3D street level mapping • European coverage	○	●	●	▲	591.67	710.00
Media connections: • USB connection with iPod control • Aux-in socket • Bluetooth A2DP audio streaming (Advanced Audio Distribution Profile)						
Mobile phone portal: • Bluetooth® connectivity • Handfree calls via steering wheel controls • Vehicle microphone • Phone book access – <i>Contacts/last calls/missed calls etc. are mirrored on IntelliLink's display and are easily navigated using the touchscreen (features dependent on mobile phone)</i>						
Smartphone interface: • Apple CarPlay™ • Android Auto™						
Bose® Premium Sound System (only available with Navi 900 IntelliLink system, spare wheel and Electro Pack) • Six channel amplifier with digital signal processing • Two A-pillar mounted 2.5cm tweeters • Two front door mounted 16.5cm woofers • Two rear door mounted 13cm wide-range speakers • One 13cm Richbass woofer in custom 8-litre bass box in luggage compartment	○	○		○	495.83	595.00
Six speakers (four front, two rear)	●	●	●	●		
Steering wheel mounted audio controls	●	●	●	●		

● = Standard equipment. ○ = Optional at extra cost. ▲ = Standard on Nav models, see pricing page for details.



MOKKA X FEATURES / OPTIONS

SEATING AND COMFORT	Active	Design Nav	Griffin / Griffin Plus	Elite	Price (£) exc. VAT	Total (£) inc. VAT
Reach and rake adjustable steering	●	●	●	●		
Cloth front seats						
Driver's seat (eight-way adjustable): • Height (up/down) • Reach (fore/aft) • Backrest recline (upright/incline) • Head restraint (up/down)	●	●				
Front passenger's seat (six-way adjustable): • Reach (fore/aft) • Backrest (upright/recline) • Head restraint (up/down)						
Ergonomic active front seats (AGR-certified†)						
Driver's and front passenger's seat (18-way adjustable): • Height (up/down) • Reach (fore/aft) • Tilt (electrical fore/aft)			●	●		
• Backrest (upright/recline) • Seat cushion extension (fore/aft) • Lumbar adjustment (four-way electrical) • Head restraint (up/down/fore/aft)						
• Heated front seats			●	●		
Ergonomic active front driver's seat (AGR-certified†)	○	○			275.00	330.00
Rear seating						
• Three-person layout • 60/40 split flip and fold rear seat • Height-adjustable and removable outer seat head restraints						
• ISOFIX child seat mountings incorporating top tether anchor points located on outer rear seats (does not include child seat) – Allows ISOFIX child safety seats to be securely fixed into the car. The ISOFIX mounting system reduces forward movement in an accident and makes the child seat easier to install. • Child-proof locks on rear doors	●	●	●	●		
Centre rear seat head restraint				●		

● = Standard equipment. ○ = Optional at extra cost.

† = AGR (The Campaign for Healthier Backs) is an independent centre of excellence for ergonomics, based in Germany.

MOKKA X FEATURES / OPTIONS

	Active	Design Nav	Griffin / Griffin Plus	Elite	Price (£) exc. VAT	Total (£) inc. VAT
HEATING AND VENTILATION						
Electronic climate control including air conditioning <ul style="list-style-type: none"> • Dual-zone control – <i>Allowing different temperature settings for driver and front passenger.</i> • Advanced predictive logic control system using humidity sensors • Partial air recirculation – <i>Faster warm up/cool down</i> • Cabin particulate filter – <i>Removes dust, airborne particles and pollen.</i> • Automatic air direction and fan speed with manual override • Illuminated controls 	●	●	●	●		
Additional features <ul style="list-style-type: none"> • Four adjustable facia vents • Windscreen demist vents • Side window demist vents • Heated rear screen with timed cut-off 	●	●	●	●		
Winter Pack <ul style="list-style-type: none"> • Heated leather-covered steering wheel • Heated front seats 	○	○	●	●	237.50	285.00
 Warm welcome						

INTERIOR CONVENIENCE

Convenience features <ul style="list-style-type: none"> • Front 12-volt electrical accessory socket • Front and rear passenger assist handles 	●	●	●	●
Rear seat centre armrest with drinks holders				●
Front driver's armrest	●	●	●	●

INTERIOR LIGHTING

Standard lighting <ul style="list-style-type: none"> • Courtesy lighting operated by door switches 	●	●	●	●
---	---	---	---	---

INTERIOR STORAGE

Interior storage <ul style="list-style-type: none"> • Illuminated glovebox with lid • Front door pockets • Storage pocket on front passenger's seat back • Two drinks holders in centre console • Storage pocket on driver's seat back • Front passenger's underseat storage tray 	●	●	●	●
Luggage area <ul style="list-style-type: none"> • Luggage compartment foldable cover • Illuminated luggage area • Fully carpeted luggage area 	●	●	●	●

● = Standard equipment. ○ = Optional at extra cost.

MOKKA X FEATURES / OPTIONS

	Active	Design Nav	Griffin / Griffin Plus	Elite	Price (£) exc. VAT	Total (£) inc. VAT
MECHANICAL						
Front-wheel drive	●	●	●	●		
Intelligent four-wheel drive (4X4 models only)				▲		
Six-speed manual gearbox	●	●	●	●		
Six-speed automatic transmission	▲	▲	▲	▲		
EXTERIOR LIGHTING						
Standard lighting features <ul style="list-style-type: none"> • LED daytime running lights • Automatic lighting control • Halogen headlights • Lights-on audible warning • Manual headlight beam levelling • High-level LED centre rear brake light • Rear fog light • Reversing light • Hazard warning lights • Door-to-door illumination 	●	●	●	●		
Front fog lights	●	●	●	●		
Premium LED Adaptive Forward Lighting (AFL) – Only available with Sight and Light Pack on Design and Active models. Six LED elements light the road 30% brighter than halogen, allowing you to see hazards sooner and giving you more time to react. The AFL system uses data such as vehicle speed, steering angle and when the indicators are used to determine the most suitable lighting. <ul style="list-style-type: none"> • Enhanced colour driver information display • Intelligent main beam control • Automatic headlight levelling • LED tail lights Every type of driving environment has been considered: Urban light: With street lighting and speeds below 35mph, the system automatically enhances the dipped beam function. Country light: As speeds increase, so does the lighting's performance. Dynamic curve light: At speeds between 25mph and 45mph, and above a set steering angle, extra light is projected onto the relevant side of the road to give you a better view. Static cornering light: At lower speeds, when you indicate and turn the steering above a certain angle, corners and bends are illuminated to match steering inputs. Parking light: When reversing, additional side-facing lights are activated in the headlights. Energy saving mode: On Start/Stop models, the system deactivates the static cornering light function when Start/Stop mode is active. Tourist mode: If you're driving on the continent, switch to Tourist mode and your lights will dip automatically for oncoming traffic. High beam: Powerful down-the-road illumination on top of the LED low beam. Full-on lighting for maximum visibility.	○	○		○	966.67	1160.00
LED tail lights (standard with optional Premium LED Adaptive Forward Lighting) – Only available with Sight and Light Pack on Design and Active models.	○	○		○	166.67	200.00









● = Standard equipment. ○ = Optional at extra cost. ▲ = See price page for details.

MOKKA X FEATURES / OPTIONS

	Active	Design Nav	Griffin / Griffin Plus	Elite	Price (£) exc. VAT	Total (£) inc. VAT
EXTERIOR CONVENIENCE						
Windscreen wipers • Two-speed windscreen wipers with variable intermittent wipe • Intermittent rear window wash/wipe	●	●	●	●		
Door mirrors • Twin electrically adjustable/heated door mirrors (wide-angle on driver's side) with automatic timed cut-off	●	●	●	●		
Windows • Electrically operated front windows with safety autoreverse and one-touch facility • Electrically operated rear windows • Heated rear window	●	●	●	●		
Power tilt and slide glass sunroof with manually operated sunblind	○	○		○	420.83	505.00
Roof rails, silver-effect	●	●	●	●		
EXTERIOR STYLING						
Body styling • Alloy-effect protective front skid plate • Side-protection mouldings • Chrome-effect front grille bar • Body-colour door handles • Body-colour door mirrors • Stainless steel exhaust tailpipe	●	●	●	●		
• Chrome-effect side window trim			●	●		
• Black B-pillars	●	●	●	●		
Windows • Solar heat-absorbing windscreen • Tinted windows	●	●	●	●		
• Dark-tinted rear windows	○	○		○	237.50	285.00

● = Standard equipment. ○ = Optional at extra cost.

MOKKA X FEATURES / OPTIONS

EXTERIOR COLOURS**		Active	Design Nav	Griffin / Griffin Plus*	Elite	Price (£) exc. VAT	Total (£) inc. VAT
	Aegean Blue • Solid paint • Not available with Morello Red trim	●	●		●		
	Summit White • Brilliant paint			●	○	237.50	285.00
	Lava Red • Brilliant paint • Not available with Morello Red trim	○	○	●	○		
	Sovereign Silver • Two-coat metallic paint			●	○	479.17	575.00
	Mineral Black • Two-coat metallic paint	○	○	●	○		
	Satin Steel Grey • Two-coat metallic paint • Not available with Morello Red trim			●	○		
	Amber Orange • Two-coat Premium paint • Not available with Morello Red trim			●	○	545.83	655.00
	Velvet Red • Two-coat Premium paint	○	○	●	○		
	Abalone White • Tri-coat premium paint	○	○	●	○	604.17	725.00





● = Standard equipment. ○ = Optional at extra cost. N/C = No-cost option.

The colours reproduced may vary slightly from the actual paint colour. As a result they should be used as a guide only. Your Vauxhall Retailer has a comprehensive display of our paint samples.

*Colours and model variants for Griffin special edition subject to availability. Please check with your Vauxhall Retailer.

**Please note, all exterior colours are subject to availability. Please check with your Vauxhall Retailer.

MOKKA X FEATURES / OPTIONS

WHEELS AND TYRES		Active	Design Nav	Griffin / Griffin Plus	Elite	Price (£) exc. VAT	Total (£) inc. VAT
Steel emergency spare wheel (in lieu of emergency tyre inflation kit)		○	○		○	91.67	110.00
	17-inch silver-effect alloy wheels • 215/60 R 17 tyres • Emergency tyre inflation kit (in lieu of spare wheel)	●	●		●		
	18-inch 10-spoke alloy wheels • 215/55 R 18 tyres • Emergency tyre inflation kit (in lieu of spare wheel) • Standard on Griffin models			●			
	18-inch diamond-cut bi-colour 10-spoke alloy wheels • 215/55 R 18 tyres • Emergency tyre inflation kit (in lieu of spare wheel)				○	320.83	385.00
	18-inch black 10-spoke alloy wheels • 215/55 R 18 tyres • Emergency tyre inflation kit (in lieu of spare wheel)	○	○		○	320.83	385.00
	19-inch 5-twin-spoke alloy wheels • 225/45 R 19 tyres • Emergency tyre inflation kit (in lieu of spare wheel) • Standard on Griffin Plus models	○	○	●	○	508.33	610.00

● = Standard equipment. ○ = Optional at extra cost.

MOKKA X SPECIFICATIONS

PETROL ENGINE

1.4i Turbo (140PS)	
Capacity	1364cc
Maximum power	140PS (103kW) @ 4900-6000rpm
Maximum torque	200Nm (147 lb.ft.) @ 1850-4900rpm
Configuration	4 cylinders, 4 valves per cylinder, double overhead camshafts
Fuel/induction system	Turbocharger with intercooler. Variable Valve Timing. Multi-point sequential fuel injection
Emission compliance	Euro 6d-TEMP (6.2)
Service interval	20,000 miles or 1 year (whichever occurs sooner)

DIESEL ENGINE

1.6CDTi (136PS)	
Capacity	1598cc
Maximum power	136PS (100kW) @ 3500-4000rpm
Maximum torque	320Nm (236 lb.ft.) @ 2000-2250rpm
Configuration	4 cylinders, 4 valves per cylinder, double overhead camshafts
Fuel/induction system	Variable geometry turbocharger with intercooler. Common rail fuel injection
Emission compliance	Euro 6d-TEMP (6.2). Diesel Particulate Filter
Service interval	20,000 miles or 1 year (whichever occurs sooner)

PERFORMANCE, FUEL ECONOMY AND EMISSIONS

	Performance (manufacturer's figures)			Fuel economy mpg (litres/100km)#		CO ₂ emissions	Vehicle Excise Duty**		Benefit in kind company car taxation rates – 2019/20 tax year
	Wheel size	Maximum speed	Acceleration 0-60mph	Combined Low	Combined High		First year rate	Standard rate	
Petrol models									
1.4i Turbo (140PS) S/S ecoTEC FWD	17	122	9.6	36.7 (7.7)	39.2 (7.2)	147	£210	£145	33%
1.4i Turbo (140PS) S/S ecoTEC FWD	18/19	122	9.6	36.7 (7.7)	39.2 (7.2)	150	£210	£145	34%
1.4i Turbo (140PS) auto FWD	17	119	10.1	34.4 (8.2)	37.2 (7.6)	157	£530	£145	35%
1.4i Turbo (140PS) auto FWD	18/19	119	10.1	34.4 (8.2)	37.2 (7.6)	162	£530	£145	36%
1.4i Turbo (140PS) S/S 4X4	17	116	9.3	34.0 (8.3)	36.7 (7.7)	162	£530	£145	36%
1.4i Turbo (140PS) S/S 4X4	18/19	116	9.3	34.0 (8.3)	36.7 (7.7)	167	£530	£145	37%
Diesel models									
1.6CDTi (136PS) S/S BlueInjection ecoTEC FWD	17	118	9.3	48.7 (5.8)	50.4 (5.6)	127	£210	£145	33%
1.6CDTi (136PS) S/S BlueInjection ecoTEC FWD	18/19	118	9.3	48.7 (5.8)	50.4 (5.6)	131	£530	£145	34%

S/S = Start/Stop. FWD = Front-wheel drive.

= Fuel consumption figures are determined according to the WLTP test cycle. Full data relating to WLTP test cycles can be found at: www.vauxhall.co.uk/wltp

*CO₂ emissions figures are determined according to the WLTP test cycle however, a Government formula is then applied to translate these figures back to what they would have been under the outgoing NEDC test cycle, which WLTP replaces. The correct tax treatment is then applied.

Figures are intended for comparability purposes only. The fuel consumption you achieve under real life driving conditions and CO₂ produced will depend upon a number of factors, including the accessories fitted after registration, variations in driving styles, weather conditions and vehicle load. Only compare fuel consumption and CO₂ with other vehicles tested using the same technical procedures. For more information contact your local Vauxhall Retailer.

** = Correct at time of publication.

MOKKA X SPECIFICATIONS

TRANSMISSIONS

Six-speed manual gearbox:

All models

Six-speed automatic transmission with Active Select function:

Available at extra cost on 1.4i (140PS) front-wheel drive models. Electronically controlled with adaptive driving function and fuel-saving eco mode. Fluid drive with torque converter, lock-up clutch and Active Select.

Intelligent 4X4

Electronically controlled four-wheel drive with variable torque split between front and rear axles.

- Torque transfer device: When pulling away from standstill, or under acceleration, more power is diverted to the rear wheels for maximum grip
- Electronic limited-slip differential: Fitted to the rear axle, it can transfer up to 50% of the rear axle torque between the rear wheels

STEERING

- Speed-sensitive power-assisted steering
- Turning circle (wall-to-wall): 11.50m (37.7ft)

SUSPENSION

Front: Independent. Lightweight MacPherson struts with gas-pressure dampers and coil springs. Anti-roll bar.

Rear: Torsion beam with coil springs and gas-pressure dampers.

BRAKING AND STABILITY

- Switchable Electronic Stability Programme (ESP)
- Cornering brake control
- Straight line stability control
- Rollover mitigation
- Traction control
- Hill start assist
- Anti-lock Braking System (ABS)
- Emergency brake assist
- Electronic brakeforce distribution
- Adaptive brake lights
- Hazard warning lights

All models

Front ventilated discs: 300mm diameter

Rear discs: 268mm diameter

BODY

- Aerodynamic drag co-efficient: Cd 0.35

FUEL TANK CAPACITY

- 53 litres (11.7 gallons)

ADBLUE TANK CAPACITY



- 9.6 litres (2.1 gallons)

INSURANCE GROUPS

	Active	Design Nav	Griffin	Griffin Plus	Elite/Elite Nav
1.4 Turbo (140PS) S/S ecoTEC FWD	14E	13E	13E	14E	14E
1.4 Turbo (140PS) auto FWD	14E	13E	13E	14E	14E
1.4 Turbo (140PS) S/S 4X4	–	–	–	–	14E
1.6CDTi (136PS) S/S ecoTEC BlueInjection FWD	15E	14E	15E	16E	15E

S/S = Start/Stop.

TYRES RATING

Tyre size	Fuel efficiency group	Wet grip performance	External noise	
			Measured (dB)	Group
215/60 R 17	B-C	B	71	
215/55 R 18	E	B	71	
225/45 R 19	E	A	71	

Tyre rating according to EU Regulation 1222/2009

MOKKA X SPECIFICATIONS

EXTERIOR DIMENSIONS millimetres (inches)

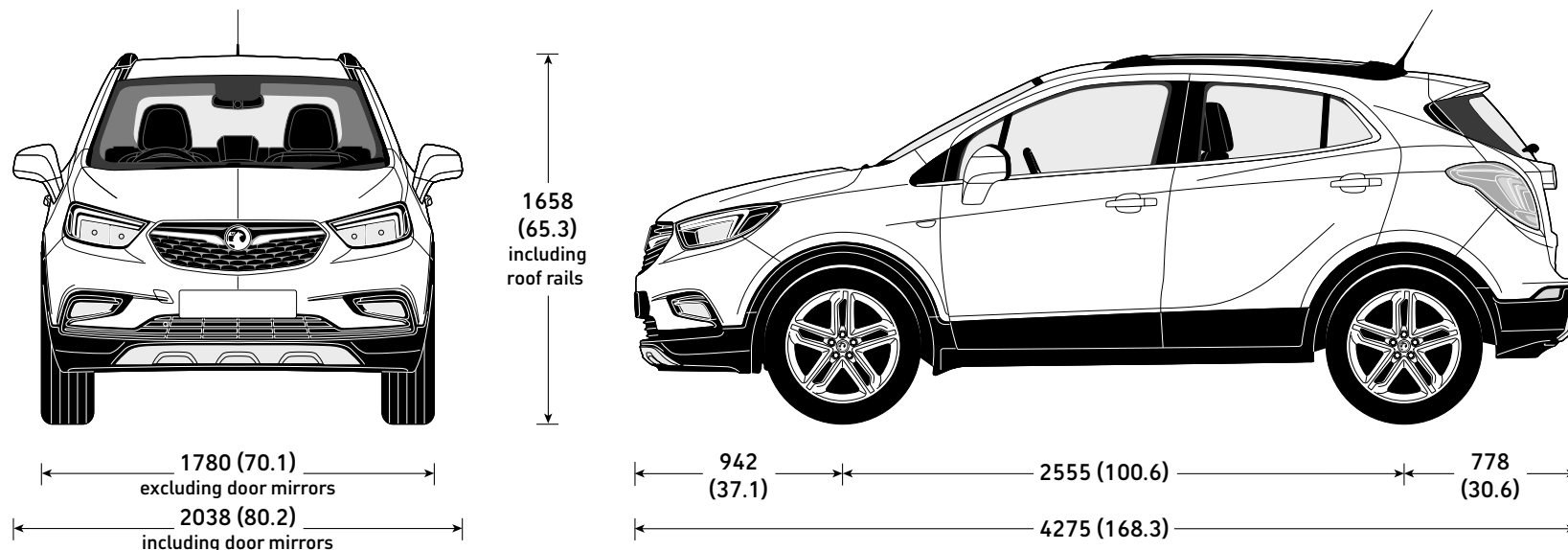

WEIGHTS AND TOWING DATA kg

	Gross vehicle weight	Max. towing weights Trailer with brakes (without brakes)
1.4i Turbo (140PS) ecoTEC FWD	1828	1200 (500)
1.4i Turbo (140PS) FWD automatic	1843	1200 (500)
1.4i Turbo (140PS) 4X4	1879	1200 (500)
1.6CDTi (136PS) ecoTEC FWD manual	1883	1500 (500)

FWD = Front-wheel drive.

Gross vehicle weight is the total permissible weight of the vehicle including passengers and their luggage. The maximum roof rack loading should not exceed 75kg. The maximum towing weights are based on the ability of the car, with two occupants of 75kg each, to restart on a 12% gradient, which is approximately 1 in 8.3, at sea level. At altitudes above 1500 metres, the engine output may drop with a corresponding reduction in towing capability. Any extra weight, such as luggage or additional passengers, should be deducted from the maximum towing weight. With a trailer fully loaded maximum noseweight should not exceed 75kg. Always fit Vauxhall towing attachments and accessories available from your Vauxhall Retailer. They are designed specifically for Vauxhall models and carry a 12-month guarantee.

LOADSPACE DIMENSIONS millimetres (inches)

Maximum length (behind rear seats)	731 (28.8)
Maximum length (rear seats folded)	1428 (56.2)
Maximum width	1006 (39.6)
Width between wheel arches	915 (36.0)
Maximum height	808 (31.8)

LOADSPACE CAPACITIES* litres (cu.ft.)

Rear seats up (under luggage compartment cover)	356 (12.6)
Rear seats folded (to upper edge of front seat back)	785 (27.7)
Rear seats folded (to roof)	1305 (46.1)

* = Measured using the ECIE method.

MOKKA X ACCESSORIES

	Total (inc. VAT)
CHILD SEATS¹	
BABY-SAFE ² – 0-13kg/birth to 15 months	£141
– ISOFIX base	£244
DUO ISOFIX ² – 9-18kg/9 months to 4 years with top tether kit	£372
KID ² –15-36kg or 4 to 12 years	£168

1 = Restrictions apply to the use of child seats, please consult your Vauxhall Retailer or request a copy of the Child seats brochure.

2 = Without transponder.

	Total (inc. VAT)
SAFETY	
Privacy shades – rear side windows	£106
Privacy shades – tailgate window	£93
Safety Pack – first aid kit, hi-visibility vest and small warning triangle	£30
Warning triangle – Small	£12
Warning triangle – Large	£20
First aid kit	£15
Hi-visibility vest	£9
Fire extinguisher – 2kg	£39
Tyre sealant	£80

	Total (inc. VAT)
FLEXCONNECT RANGE	
FlexConnect bracket	£22
FlexConnect hook	£32
FlexConnect coat hanger	£34
FlexConnect folding table	£77
FlexConnect iPad Mini cradle	£109
FlexConnect iPad (1-4) cradle	£118
FlexConnect iPad Air cradle	£117
FlexConnect Samsung Galaxy cradle	£107

PRACTICAL	
Premium spare bulb kit ³	£36
Stretch tow rope – 3 tonne	£36
Smoker pack	£41

3 = Excludes xenon headlight bulb for models with Adaptive Forward Lighting (AFL).

PROTECTION	
Rubber floor mats – set of four	£57
Velour floor mats (Black) – set of four	£59
Velour floor mats (Brown) – set of four	£53
Cargo liner	£85
Cargo net – horizontal	£46
Dog guard	£173
Mudflaps – front and rear ⁴	£98
Load compartment mat (Brown)	£97
Load compartment storage box	£93

4 = Not available with certain exterior styling products.

	Total (inc. VAT)
TRANSPORT SYSTEMS	
Roof base carrier	£151
Roof carriers (requires base carrier)	
Bike roof carrier – Thule Freeride 532	£78
Surf board roof carrier – Thule 833	£82
Kayak roof carrier – Thule 837	£172
Ski roof carrier (up to 4 pairs) – Thule 7324	£161
Ski roof carrier (up to 6 pairs) – Thule 7326	£190

Hard shell roof boxes (requires base carrier)

Thule Ocean 80 (320 litre / 1330 x 860 x 370mm)	£154
Thule Ocean 200 (450 litre / 1750 x 820 x 450mm)	£323
Thule Motion 800 (460 litre / 2050 x 840 x 450mm)	from £463
Thule Touring 200 (400 litre / 1750 x 820 x 450mm)	£338
Thule Touring 700 (430 litre / 2320 x 700 x 420mm)	£384

Tow bar carrier system

Fixed tow bar ⁵	£572
Detachable tow bar ⁵	£658

5 = Available with 13 pin electrics. Please consult your retail or for details.

	Total (inc. VAT)
STYLING	
Decal styling kit	from £204
Rear spoiler kit	£266
Side steps	£428
Styling kit	£613
Door sill plates	£56

ALLOY WHEELS (set of four with centre caps)⁶

17-inch 5-spoke	£1,080
18-inch 5-spoke	£1,546
18-inch 10-spoke	£1,546
19-inch 5-double spoke	£2,021

Other designs available

6 = Different tyres and locking wheel bolts/nuts may be required at extra cost. Price excludes new tyres and locking wheel bolts/nuts, includes static wheel balancing.

Please note:

Prices shown are fully fitted and painted, where applicable and include VAT. Please check with your local Vauxhall Retailer for details. It is advisable to ensure your insurance policy is adequate to cover additional fitted accessories. Prices correct at time of publication.

MOKKA X COMPANY CAR DRIVER/FLEET INFORMATION

DESIGN AND TECH LINE NAV HIGH SPEC, LOW P11D

Specifically developed for businesses and company car drivers alike, our Design and Tech Line Nav models are seriously fit for Fleet.

Design models all feature very low P11D values, generous standard specification, including Sat Nav on Design Nav models, and a choice of high tech ecoTEC engines for great fuel economy and low emissions.

For even more standard specification, step up to our Tech Line Nav range. Again you are guaranteed low P11D values, plus great standard kit including Sat Nav, Bluetooth®, USB connection, aux-in socket and digital radio.

With Design and Tech Line Nav you can take for granted low Whole Life Costs and low company car driver taxation.



COMPANY CAR DRIVER FREE 3 DAY TEST DRIVE

Our free* 3 Day Test Drive programme is open to all Company Car Drivers. It allows you to choose most models in the current Vauxhall line-up (exclusions apply). With full insurance cover provided, it gives you a meaningful length of time to make an informed decision about your next company car.

Search Vauxhall 3DTD to book your FREE* test drive or click the link the below:

[Vauxhall 3 Day Test Drive](#)

*The free 3 Day Test Drive programme is open to Company Car Drivers and Fleet Decision Makers. Available for UK Mainland only. Terms and conditions apply. Full terms and conditions can be found at vauxhallfleet.co.uk/testdrive/index/terms.

BENEFIT IN KIND COMPANY CAR TAXATION†

The car benefit charge will be the car's list price (including VAT, options and accessories fitted, delivery to Retailer and number plates, but excluding Vehicle Excise Duty and new vehicle first registration fee) multiplied by the percentage charge for the CO₂ emissions band in which the car falls (see table opposite). Multiply this figure by your personal income tax rate (20%†† for Basic Rate, 40%†† for Higher Rate) to calculate your annual benefit in kind tax liability.

Example:

Mokka X Design Nav 1.6CDTi (136PS) Start/Stop ecoTEC BlueInjection FWD (CO ₂ emissions 127g/km)	
On-the-road RRP	£22325.00
Deduct: Vehicle Excise Duty	(£210.00)
New vehicle first registration fee	(£55.00)
Effective list price	£22060.00
Add: Optional two-coat metallic paint	£575.00

List price for tax purposes (P11D value)	£22635.00
--	-----------

Car benefit charge	
2019-20 tax year (33%)	£7470.00
Benefit in kind tax liability (2019-20 tax year)	
Basic Rate (20%) tax payer	£1494.00
Higher Rate (40%) tax payer	£2988.00

† = Please note this Price Guide provides taxation information as a guide only. Vauxhall does not provide taxation guidance. Drivers should always take professional advice on their own tax position. †† = Excludes residents of Scotland.

BIK FOR SCOTTISH RESIDENTS

Effective 6 April 2018 the Scottish Government have introduced their own BIK taxation structure. This only applies to Company Car Drivers that are Scottish taxpayers. HMRC will determine whether or not an individual is a Scottish taxpayer based on where their main place of residence is.

The BIK rates for Scotland are:

- Over £12,500-£14,549 Starter Rate 19%
- Over £14,549-£24,994 Basic Rate 20%
- Over £24,994-£43,430 Intermediate Rate 21%
- Over £43,430-£150,000 Higher Rate 41%
- Above £150,000 Top Rate 46%

CO ₂ emissions in grams per kilometre	Percentage of car's price to be taxed	
	Non - Diesel†	Diesel††
	2019-20 tax year	2019-20 tax year
Up to 50	16	20
51-75	19	23
76-94	22	26
95-99	23	27
100-104	24	28
105-109	25	29
110-114	26	30
115-119	27	31
120-124	28	32
125-129	29	33
130-134	30	34
135-139	31	35
140-144	32	36
145-149	33	37
150-154	34	37
155-159	35	37
160-164	36	37
165-169	37	37
170-174	37	37
175-179	37	37
180 and above	37	37

† = Also applies to diesel vehicles that meet the Real Driving Emissions Step 2 (RDE2). †† = Applies to vehicles that do not meet the Real Driving Emissions Step 2 (RDE2).

To calculate your own personal liability, search: **Vauxhall BiK**, or click the link below:

[Vauxhall BiK Tool](#)

FLEET TOOLBOX



Discover the facts in our online Toolbox for both Company Car Drivers and Fleet Decision Makers. The Fleet Toolbox has a host of useful calculators, comparators, interactive listings and information.

Search Vauxhall Fleet Tools or click the link below: [Vauxhall Fleet Tool Box](#)

CONTACT VAUXHALL FLEET

Please contact one of our dedicated sales teams who will be happy to help with your particular enquiry.

Company Car Drivers

Call: 0345 111 2020

Email: company-car@vauxhallinfo.co.uk

Telephone lines are open

– Monday to Friday 8.00am-9.00pm

– Saturday and Sunday 9.00am-6.00pm

Fleet Decision Makers

Depending on the size of your fleet of vehicles, we have a dedicated team to handle your enquiries.

The lines are open Monday to Friday excluding Bank Holidays.

1-24 vehicles

Call: 0845 076 2254 (8.30am-5.00pm)

25+ vehicles

Call: 0330 587 8222 (8.30am-5.00pm)

Email: vauxhallfleet@vauxhall.co.uk

Special Vehicles (Police, Fire and Ambulance)

Call: 01582 409999 (8.30am-5.00pm)

Email: vauxhallspecialvehicles@vauxhall.co.uk

MOKKA X ADDITIONAL INFORMATION

ON-THE-ROAD PRICES

To eliminate uncertainty about hidden costs when buying a new car, Vauxhall publishes on-the-road recommended retail prices (RRP) and these are shown in the pricing tables within this price guide. These prices include VAT, number plates and delivery to Retailer of £700.00 (including £116.67 VAT), 12 months' Government Vehicle Excise Duty (see opposite for details) and the DVLA new vehicle first registration fee of £55.00*.

Please note: The on-the-road recommended retail price (RRP) does not include fuel supplied by the Retailer, motor insurance or any other goods or services supplied by agreement between the Retailer and the customer.

PRICE PROTECTION

Order a new Vauxhall for build in the current model year (as confirmed by your Retailer) for delivery no more than three months in advance and the price you are quoted is the price you pay. This is irrespective of any subsequent price rises between placing your order and delivery of your new car, but you must take delivery as soon as the car is available. Vauxhall Motors Limited is not liable for price adjustments caused by Government changes in the rate of VAT (currently 20%), Vehicle Excise Duty, DVLA new vehicle first registration fee or by any other applicable legislation or regulations.

VAUXHALL FINANCE LEASING

Vauxhall Finance Leasing is a trading style of Vauxhall Finance plc. Working with the Vauxhall Retailer network we provide competitive car and van leasing solutions for business users and private individuals. We combine the support of a national contract with the convenience of a local contact. For further information, please contact your local Vauxhall Retailer or visit www.vauxhall.co.uk/leasing

IN THE EVENT OF AN ACCIDENT...

Vauxhall Accident Management helps keep you mobile following an accident. Benefits include vehicle recovery, Vauxhall-approved repairs and contacting your insurer. For more details, visit vauxhall.co.uk/AccidentManagement

VEHICLE EXCISE DUTY

The amount of Vehicle Excise Duty (road fund licence) payable on new cars varies depending on the level of carbon dioxide (CO₂) emissions produced by the vehicle. CO₂ emissions are measured in grammes (g) per kilometre (km) travelled and divided into 13 charging bands shown in the table below.

A 'first year rate' of Vehicle Excise Duty is payable on all new cars and in subsequent years the amount payable reverts to the 'standard rate'. From 1 April 2017 the breakpoints for each of these bands have been revised. Also, for vehicles with a list price over £40,000, including factory-fitted options, an additional £320 is payable for the first five years of standard rate payments.

VEHICLE EXCISE DUTY*

	CO ₂ emissions	First year rate		Standard rate
		Non-diesel**	Diesel†	
Band A	0g/km	£0.00	£0.00	£0.00
Band B	1 – 50g/km	£10.00	£25.00	£145.00
Band C	51 – 75g/km	£25.00	£110.00	£145.00
Band D	76 – 90g/km	£110.00	£130.00	£145.00
Band E	91 – 100g/km	£130.00	£150.00	£145.00
Band F	101 – 110g/km	£150.00	£170.00	£145.00
Band G	111 – 130g/km	£170.00	£210.00	£145.00
Band H	131 – 150g/km	£210.00	£530.00	£145.00
Band I	151 – 170g/km	£530.00	£855.00	£145.00
Band J	171 – 190g/km	£855.00	£1,280.00	£145.00
Band K	191 – 225g/km	£1,280.00	£1,815.00	£145.00
Band L	226 – 255g/km	£1,815.00	£2,135.00	£145.00
Band M	over 255g/km	£2,135.00	£2,135.00	£145.00

* = Correct at time of issue. ** = Also applies to diesel vehicles that meet the Real Driving Emissions Step 2 (RDE2).

† = Applies to vehicles that do not meet the Real Driving Emissions Step 2 (RDE2).

TRUST VAUXHALL

CUSTOMER CARE COMMITMENT

For added peace of mind, Vauxhall has an innovative Customer Care Commitment that offers the following:

- Three-year vehicle warranty consisting of a one-year/unlimited mileage manufacturer's warranty and a second and third year manufacturer's warranty with a 60,000 miles limitation
- Vauxhall Assistance for 12 months from first registration
- Six years' body panel anti-perforation warranty

Please note: Warranty is only available on vehicles sourced from Vauxhall Motors Limited. Terms and conditions apply – please see your Vauxhall Retailer for details.

VAUXHALL ASSISTANCE

Vauxhall Assistance is provided automatically with every new Vauxhall for 12 months from first registration and covers everything from accident assistance, roadside recovery and 'at home' service to flat tyres. With Vauxhall Assistance help is literally just a free* phone call away, 24 hours a day, 365 days a year!

* = Mobile phone users will be charged at their standard tariff.

PROTECTING THE ENVIRONMENT

Vauxhall's commitment to the environment is demonstrated by our products' many environmental awards. For even more information on Vauxhall's efforts to achieve an environmentally sustainable future, and how to dispose of your end-of-life vehicle, see www.vauxhall.co.uk/recycling

VAUXHALL SERVICE PLAN

- Fixed monthly payments for the plan duration
- Easy to budget and interest-free
- Genuine parts fitted by Vauxhall-trained technicians

Plus on Gold plans:

- Valet and courtesy car
- Vauxhall Roadside Assistance
- Engine flush and fuel treatments
- Litre of oil for top ups between services

Full details can be obtained from your local participating Vauxhall Retailer.

VAUXHALL INSURANCE WITH ADDED REASSURANCE

Comprehensive cover – Summary of benefits**

- Competitive premiums
- Repairs by a Vauxhall-trained technician
- Genuine Vauxhall parts, guaranteed for three years when we repair your car within our Approved Repairer Network
- Free courtesy car as standard when using an Approved Repairer†
- 24 hour claims helpline
- Personal Accident benefit
- Cover for audio equipment
- Windscreen cover

Call for a quote on 0844 463 2670††

** = The benefits listed above are for comprehensive cover only. For details of Third Party, Fire and Theft cover, please call our sales team.
† = Should your car need repairing following an accident we provide a courtesy car (subject to availability) for the duration of the repair. Only genuine Vauxhall parts are used. Terms and conditions apply.
†† = Calls may be recorded. Vauxhall Insurance is underwritten by Ageas Insurance Limited.

FOR MORE PRODUCT INFORMATION

For further information on the Vauxhall range or location of your nearest Vauxhall Retailer please call **0345 600 1500**. Alternatively, details can be found on our website at www.vauxhall.co.uk

JOIN US ONLINE:



Privacy Policy – For full details please visit: vauxhall.co.uk/privacy

The invoice price, including delivery to Retailer, factory-fitted options, accessories fitted by the Retailer and number plates, is subject to VAT. Some feature descriptions in this guide may refer to, and some illustrations may show, optional equipment not included in the standard delivery. The information contained in this guide was accurate at the time of publication. We reserve the right to make changes in design and equipment. Please note that Vauxhall Retailers are not the agents of Vauxhall Motors Limited and are not authorised to bind Vauxhall Motors Limited by any specific or implied undertaking or representation. It is advisable to ensure that your motor insurance policy provides adequate cover for additional fitted options and accessories. The colours in this guide are only approximate actual colours. Illustrated optional equipment is available at extra charge. Availability, technical features and equipment provided on our vehicles can vary by model. For precise information on the equipment provided on our vehicles, please contact your local Vauxhall Retailer.

VAUXHALL

vauxhall.co.uk

©2019 Vauxhall Motors Limited

Published 1 April 2019 (Amended 9 May 2019) Vauxhall Motors Limited, Luton LU4 9TT

GRANDLAND X

Price and Specification Guide | 23 May 2019 | Model Year 2019.5



VAUXHALL
British Brand since 1903

CONTENTS

To find the information you want use the links below to navigate around the guide:

[RANGE HIGHLIGHTS >](#)

Explore the Grandland X range and find your perfect model.

[MODELS >](#)

Find all the information you need about your chosen model.

[PRICES >](#)

Find on-the-road recommended retail prices.

[FEATURES/OPTIONS >](#)

Tailor your chosen model to suit your needs with everything from satellite navigation to rear-view camera and parking sensors.

[EXTERIOR COLOURS >](#)

Add some sparkle to your car with a metallic paint.

[WHEELS AND TYRES >](#)

Why not upgrade to a set of distinctive alloy wheels to give your car more presence.

[PERFORMANCE, FUEL ECONOMY AND EMISSIONS >](#)

Know how many miles you will get around town, the CO₂ figures and the 0-60 time.

[DIMENSIONS >](#)

Ensure your car will fit in the garage and know how much luggage you can take for a long weekend away.

[SPECIFICATIONS >](#)

Towing weights, engine details and other useful details you may need to know.

[ACCESSORIES >](#)

Add some practical touches to your car with our range of quality accessories.

[COMPANY CAR INFORMATION >](#)

Benefit in Kind company car tax, 3 day test drives and P11D.

[FURTHER INFORMATION >](#)

Price protection, vehicle excise duty, our range of additional products and much more.

GRANDLAND X RANGE HIGHLIGHTS



SE OTR from £23,935

Standard features include:

Infotainment:

- R4.0 IntelliLink system
 - Smartphone projection, Apple CarPlay™ and Android Auto™
 - 7-inch colour touchscreen
 - AM/FM/digital radio
 - Bluetooth® connectivity
 - USB connection with iPod control

Interior convenience/styling:

- Dual-zone electronic climate control
- Cruise control with intelligent speed adaptation
- Leather-covered steering wheel with audio controls
- Steering column adjustable for reach and rake
- 220-volt power outlet behind front seats

Exterior convenience/styling:

- 17-inch silver-effect alloy wheels
- Auto lighting/windscreen wipers
- Front fog lights

Safety/security:

- Switchable electronic stability programme
- Anti-lock braking system
- Six airbags
- Lane departure warning
- LED daytime running lights
- High beam assist
- Rear parking distance sensors
- Remote control security alarm system



DESIGN LINE OTR from £24,935

Features over SE:

Interior convenience/styling:

- Versatility Pack
 - Centre rear seat armrest with ski pass-through
 - Illuminated luggage area
 - Flex Floor with under-floor divider
- Alloy-effect sports pedals

Exterior convenience/styling:

- 18-inch diamond-cut alloy wheels
- Alloy-effect protective front and rear skid plates
- Black roof and door mirrors
- Dark-tinted rear windows
- Chrome-effect side window trim
- Electrically foldable door mirrors with puddle lights

Safety/security:

- Front parking distance sensors



TECH LINE NAV OTR from £23,565

Features over SE:

Infotainment:

- Navi 5.0 IntelliLink system
 - Fully integrated European sat nav system
 - 8-inch colour touchscreen
 - Voice control

Interior convenience/styling:

- Ergonomic active front seats
- Ambient lighting
- Versatility Pack
 - Centre rear seat armrest with ski pass-through
 - Illuminated luggage area
 - Flex Floor with under-floor divider
- Alloy-effect door sill covers

Exterior convenience/styling:

- 18-inch silver-effect alloy wheels
- Alloy-effect protective front and rear skid plates
- Chrome-effect side window trim
- Electrically foldable door mirrors with puddle lights

Safety/security:

- Front parking distance sensors
- Safety Pack
 - Driver drowsiness system
 - Forward collision alert
 - Automatic emergency braking
 - Lane assist
- Side blind spot alert

GRANDLAND X RANGE HIGHLIGHTS



SPORT NAV OTR from £26,165

Features over SE:

Infotainment:

- Navi 5.0 IntelliLink system
 - Fully integrated European sat nav system
 - 8-inch colour touchscreen
 - Voice control

Interior convenience/styling:

- Ergonomic active front seats
- Ambient lighting
- Versatility Pack
 - Centre rear seat armrest with ski pass-through
 - Illuminated luggage area
 - Flex Floor with under-floor divider
- Alloy-effect door sill covers

Exterior convenience/styling:

- Black roof and door mirrors
- 18-inch diamond-cut alloy wheels
- Alloy-effect protective front and rear skid plates
- Chrome-effect side window trim
- Electrically foldable door mirrors with puddle lights

Safety/security:

- Front parking distance sensors
- Safety Pack
 - Driver drowsiness system
 - Forward collision alert
 - Automatic emergency braking
 - Lane assist
- Side blind spot alert

ELITE NAV OTR from £27,915

Features over SE:

Infotainment:

- Navi 5.0 IntelliLink system
 - Fully integrated European sat nav system
 - 8-inch colour touchscreen
 - Voice control
- Wireless charger

Interior convenience/styling:

- Leather seat facings
- Ergonomic active front seats
- Power driver's seat
- Heated front seats
- Ambient lighting
- Versatility Pack
 - Centre rear seat armrest with ski pass-through
 - Illuminated luggage area
 - Flex Floor with under-floor divider
- Alloy-effect door sill covers

Exterior convenience/styling:

- 19-inch diamond-cut alloy wheels
- Alloy-effect protective front and rear skid plates
- Panoramic glass roof
- Heated windscreen
- Chrome-effect side window trim

Safety/security:

- Front parking distance sensors
- Safety Pack
 - Driver drowsiness system
 - Forward collision alert
 - Automatic emergency braking
 - Lane assist
- Side blind spot alert

ULTIMATE OTR from £34,935

Features over Elite Nav:

Infotainment:

- Denon premium sound system

Interior convenience/styling:

- Heated outer rear seats
- Automatic cruise control with intelligent speed adaptation
- Alloy-effect sports pedals

Exterior convenience/styling:

- Premium LED Adaptive Forward Lighting Pack with projector headlights
- Black roof and door mirrors
- Dark-tinted rear windows
- Power tailgate

Safety/security:

- Panoramic camera
- Advanced park assist
- Keyless entry and start

SE



SE ON-THE-ROAD PRICES

	5-door SUV		Insurance Group
	OTR RRP	CO ₂ (g/km)	
Petrol			
1.2 (130PS) Turbo S/S	£23,935	121	15E
1.2 (130PS) Turbo S/S auto	£25,755	121	15E
Diesel			
1.5 (130PS) Turbo D S/S BlueInjection	£25,505	111	18E
1.5 (130PS) Turbo D S/S 6-speed auto BlueInjection	£27,305	111	18E

Please note: On-the-road recommended retail prices (RRP) include VAT at 20%, number plates and delivery to Retailer of £700.00 (inc. £116.67 VAT), 12 months' Vehicle Excise Duty and new vehicle first registration fee of £55.00. Excludes fuel and insurance.

All diesel models feature BlueInjection, see www.vauxhall.co.uk/adblue.

S/S = Start/Stop.

FEATURES

Infotainment:

- R4.0 IntelliLink system
 - Apple CarPlay™ and Android Auto™
 - 7-inch colour touchscreen
 - AM/FM/digital radio
 - Bluetooth® connectivity
 - USB connection with iPod control

Interior convenience/styling:

- Dual-zone electronic climate control
- Cruise control with intelligent speed adaptation
- Multi-function trip computer
- Leather-covered steering wheel
- Steering column adjustable for reach and rake
- Steering wheel mounted audio controls
- Driver's centre armrest
- Auto anti-dazzle rear-view mirror
- 220-volt power outlet behind front seats
- 60/40 split-folding rear seat

Exterior convenience/styling:

- 17-inch silver-effect alloy wheels
- Side-protection mouldings
- Front fog lights
- Auto lighting/windscreen wipers
- Electrically adjustable/heated door mirrors
- Electrically operated front and rear windows
- Remote control central locking

Safety/security:

- Switchable electronic stability programme
- Anti-lock braking system
- Lane departure warning
- Speed sign recognition
- Traction control
- Hill start assist
- Deflation detection system
- Six airbags
- Remote control security alarm system
- Rear parking distance sensors
- Emergency tyre inflation kit in lieu of spare wheel
- LED daytime running lights
- High beam assist

DESIGN LINE



DESIGN LINE ON-THE-ROAD PRICES

	5-door SUV		Insurance Group
	OTR RRP	CO ₂ (g/km)	
Petrol			
1.2 (130PS) Turbo S/S	£24,935	121	15E
1.2 (130PS) Turbo S/S auto	£26,755	121	15E
Diesel			
1.5 (130PS) Turbo D S/S ecoTEC BlueInjection	£26,505	113	18E
1.5 (130PS) Turbo D S/S ecoTEC auto BlueInjection	£28,305	113	18E

Please note: On-the-road recommended retail prices (RRP) include VAT at 20%, number plates and delivery to Retailer of £700.00 (inc. £116.67 VAT), 12 months' Vehicle Excise Duty and new vehicle first registration fee of £55.00. Excludes fuel and insurance.

All diesel models feature BlueInjection, see www.vauxhall.co.uk/adblue.

S/S = Start/Stop.

FEATURES

Infotainment:

- R4.0 IntelliLink system
 - Apple CarPlay™ and Android Auto™
 - 7-inch colour touchscreen
 - AM/FM/digital radio
 - Bluetooth® connectivity
 - USB connection with iPod control

Interior convenience/styling:

- Dual-zone electronic climate control
- Cruise control with intelligent speed adaptation
- Multi-function trip computer
- Leather-covered steering wheel
- Steering column adjustable for reach and rake
- Steering wheel mounted audio controls
- Driver's centre armrest
- Auto anti-dazzle rear-view mirror
- 220-volt power outlet behind front seats
- Versatility Pack
 - 60/40 split-folding rear seat back
 - Centre rear seat armrest with ski pass-through
 - Illuminated luggage area
 - Flex Floor with under-floor divider
- Alloy-effect sports pedals

Exterior convenience/styling:

- 18-inch diamond-cut alloy wheels
- Alloy-effect protective front and rear skid plates
- Black roof and door mirrors
- Dark-tinted rear windows
- Chrome-effect side window trim
- Electrically foldable door mirrors with puddle lights
- Side-protection mouldings
- Front fog lights
- Auto lighting/windscreen wipers
- Electrically operated front and rear windows
- Remote control central locking

Safety/security:

- Switchable electronic stability programme
- Anti-lock braking system
- Lane departure warning
- Speed sign recognition
- Traction control
- Hill start assist
- Deflation detection system
- Six airbags
- Remote control security alarm system
- Front and rear parking distance sensors
- Emergency tyre inflation kit in lieu of spare wheel
- LED daytime running lights
- High beam assist

TECH LINE NAV



TECH LINE NAV ON-THE-ROAD PRICES

	5-door SUV		Insurance Group
	OTR RRP	CO ₂ (g/km)	
Petrol			
1.2 (130PS) Turbo S/S	£23,565	121	12E
1.2 (130PS) Turbo S/S auto	£25,385	121	12E
Diesel			
1.5 (130PS) Turbo D S/S BlueInjection	£25,125	113	14E
1.5 (130PS) Turbo D S/S 6-speed auto BlueInjection	£26,925	113	14E
2.0 (177PS) Turbo D S/S auto BlueInjection	£28,015	128	21E

Please note: On-the-road recommended retail prices (RRP) include VAT at 20%, number plates and delivery to Retailer of £700.00 (inc. £116.67 VAT), 12 months' Vehicle Excise Duty and new vehicle first registration fee of £55.00. Excludes fuel and insurance.

All diesel models feature BlueInjection, see www.vauxhall.co.uk/adblue.

S/S = Start/Stop.

FEATURES

Infotainment:

- Navi 5.0 IntelliLink system
 - Fully integrated European sat nav system
 - Apple CarPlay™ and Android Auto™
 - 8-inch colour touchscreen
 - AM/FM/digital radio
 - Bluetooth® connectivity
 - Voice control
 - USB connection with iPod control

Interior convenience/styling:

- Ergonomic active front seats
- Dual-zone electronic climate control
- Cruise control with intelligent speed adaptation
- Multi-function trip computer
- Leather-covered steering wheel
- Steering column adjustable for reach and rake
- Steering wheel mounted audio controls
- Driver's centre armrest
- Auto anti-dazzle rear-view mirror
- 60/40 split-folding rear seat
- 220-volt power outlet behind front seats
- Ambient lighting
- Versatility Pack
 - Centre rear seat armrest with ski pass-through
 - Illuminated luggage area
 - Flex Floor with under-floor divider
- Alloy-effect door sill covers

Exterior convenience/styling:

- 18-inch silver-effect alloy wheels
- Alloy-effect protective front and rear skid plates
- Front fog lights
- Auto lighting/windscreen wipers
- Electrically adjustable/heated door mirrors
- Electrically foldable door mirrors with puddle lights
- Electrically operated front and rear windows

Safety/security:

- Switchable electronic stability programme
- Anti-lock braking system
- Safety Pack
 - Driver drowsiness system
 - Forward collision alert
 - Automatic emergency braking
 - Lane assist
- Side blind spot alert
- Lane departure warning
- Speed sign recognition
- Deflation detection system
- Six airbags
- Remote control central locking/alarm system
- Front and rear parking distance sensors
- Emergency tyre inflation kit in lieu of spare wheel
- LED daytime running lights
- High beam assist

SPORT NAV



SPORT NAV ON-THE-ROAD PRICES

	5-door SUV		Insurance Group
	OTR RRP	CO ₂ (g/km)	
Petrol			
1.2 (130PS) Turbo S/S	£26,165	121	12E
1.2 (130PS) Turbo S/S auto	£27,985	121	12E
Diesel			
1.5 (130PS) Turbo D S/S BlueInjection	£27,735	113	15E
1.5 (130PS) Turbo D S/S 6-speed auto BlueInjection	£29,535	113	15E
2.0 (177PS) Turbo D S/S auto BlueInjection	£30,625	128	22E

Please note: On-the-road recommended retail prices (RRP) include VAT at 20%, number plates and delivery to Retailer of £700.00 (inc. £116.67 VAT), 12 months' Vehicle Excise Duty and new vehicle first registration fee of £55.00. Excludes fuel and insurance.

All diesel models feature BlueInjection, see www.vauxhall.co.uk/adblue.

S/S = Start/Stop.

FEATURES

Infotainment:

- Navi 5.0 IntelliLink system
 - Fully integrated European sat nav system
 - Apple CarPlay™ and Android Auto™
 - 8-inch colour touchscreen
 - AM/FM/digital radio
 - Bluetooth® connectivity
 - Voice control
 - USB connection with iPod control

Interior convenience/styling:

- Ergonomic active front seats
- Dual-zone electronic climate control
- Cruise control with intelligent speed adaptation
- Multi-function trip computer
- Leather-covered steering wheel
- Steering column adjustable for reach and rake
- Steering wheel mounted audio controls
- Driver's centre armrest
- Auto anti-dazzle rear-view mirror
- 60/40 split-folding rear seat
- 220-volt power outlet behind front seats
- Ambient lighting
- Versatility Pack
 - Centre rear seat armrest with ski pass-through
 - Illuminated luggage area
 - Flex Floor with under-floor divider
- Alloy-effect door sill covers

Exterior convenience/styling:

- 18-inch diamond-cut alloy wheels
- Black roof and door mirrors
- Alloy-effect protective front and rear skid plates
- Front fog lights
- Auto lighting/windscreen wipers
- Electrically adjustable/heated door mirrors
- Electrically foldable door mirrors with puddle lights
- Electrically operated front and rear windows

Safety/security:

- Switchable electronic stability programme
- Anti-lock braking system
- Safety Pack
 - Driver drowsiness system
 - Forward collision alert
 - Automatic emergency braking
 - Lane assist
- Side blind spot alert
- Lane departure warning
- Speed sign recognition
- Deflation detection system
- Six airbags
- Remote control central locking/alarm system
- Front and rear parking distance sensors
- Emergency tyre inflation kit in lieu of spare wheel
- LED daytime running lights
- High beam assist

ELITE NAV



ELITE NAV ON-THE-ROAD PRICES

	5-door SUV		Insurance Group
	OTR RRP	CO ₂ (g/km)	
Petrol			
1.2 (130PS) Turbo S/S	£27,915	121	14E
1.2 (130PS) Turbo S/S auto	£29,735	121	14E
Diesel			
1.5 (130PS) Turbo D S/S BlueInjection	£29,475	113	15E
1.5 (130PS) Turbo D S/S 6-speed auto BlueInjection	£31,275	113	15E
2.0 (177PS) Turbo D S/S auto BlueInjection	£32,365	128	22E

Please note: On-the-road recommended retail prices (RRP) include VAT at 20%, number plates and delivery to Retailer of £700.00 (inc. £116.67 VAT), 12 months' Vehicle Excise Duty and new vehicle first registration fee of £55.00. Excludes fuel and insurance.

All diesel models feature BlueInjection, see www.vauxhall.co.uk/adblue.

S/S = Start/Stop.

FEATURES

Infotainment:

- Navi 5.0 IntelliLink system
 - Fully integrated European sat nav system
 - Apple CarPlay™ and Android Auto™
 - 8-inch colour touchscreen
 - AM/FM/digital radio
 - Bluetooth® connectivity
 - Voice control
 - USB connection with iPod control
- Wireless charger

Interior convenience/styling:

- Dual-zone electronic climate control
- Ergonomic heated active front seats
- Leather seat facings
- Cruise control with intelligent speed adaptation
- Multi-function trip computer
- Leather-covered heated steering wheel
- Steering column adjustable for reach and rake
- Steering wheel mounted audio controls
- Auto anti-dazzle rear-view mirror
- Driver's centre armrest
- 60/40 split-folding rear seat
- 220-volt power outlet behind front seats
- Versatility Pack
 - Centre rear seat armrest with ski pass-through
 - Illuminated luggage area
 - Flex Floor with under-floor divider
- Alloy-effect door sill covers

Exterior convenience/styling:

- 19-inch diamond-cut alloy wheels
- Panoramic glass roof
- Alloy-effect protective front and rear skid plates
- Front fog lights
- Auto lighting/windscreen wipers
- Heated windscreen
- Electrically adjustable/heated door mirrors
- Electrically foldable door mirrors with puddle light
- Electrically operated front and rear windows

Safety/security:

- Switchable electronic stability programme
- Anti-lock braking system
- Safety Pack
 - Driver drowsiness system/Forward collision alert/Automatic emergency braking/Lane assist
- Side blind spot alert
- Lane departure warning
- Speed sign recognition
- Front camera system
- Traction control/hill start assist
- Deflation detection system • Six airbags
- Remote control central locking/alarm system
- Front and rear parking distance sensors
- Emergency tyre inflation kit in lieu of spare wheel
- LED daytime running lights

ULTIMATE



ULTIMATE ON-THE-ROAD PRICES

	5-door SUV		Insurance Group
	OTR RRP	CO ₂ (g/km)	
Diesel			
2.0 (177PS) Turbo D S/S auto BlueInjection	£34,935	128	24E

Please note: On-the-road recommended retail prices (RRP) include VAT at 20%, number plates and delivery to Retailer of £700.00 (inc. £116.67 VAT), 12 months' Vehicle Excise Duty and new vehicle first registration fee of £55.00. Excludes fuel and insurance.

All diesel models feature BlueInjection, see www.vauxhall.co.uk/adblue.

S/S = Start/Stop.

FEATURES

Infotainment:

- Navi 5.0 IntelliLink system
 - Fully integrated European sat nav system
 - Smartphone projection, Apple CarPlay™ and Android Auto™
 - 8-inch colour touchscreen
 - AM/FM/digital radio
 - Bluetooth® connectivity
 - Voice control
 - USB connection with iPod control
- Denon premium sound system • Wireless charger

Interior convenience/styling:

- Dual-zone electronic climate control
- Ergonomic heated active front seats
- Heated outer rear seats • Leather seat facings
- Automatic cruise control with intelligent speed adaptation
- Multi-function trip computer
- Leather-covered heated steering wheel
- Steering column adjustable for reach and rake
- Steering wheel mounted audio controls
- Auto anti-dazzle rear-view mirror
- Driver's centre armrest
- 60/40 split-folding rear seat
- 220-volt power outlet behind front seats
- Flex Floor • Alloy-effect door sill covers
- Alloy-effect sports pedals

Exterior convenience/styling:

- 19-inch diamond-cut alloy wheels
- Premium LED Adaptive Forward Lighting Pack
- Black roof and door mirrors • Panoramic glass roof
- Alloy-effect protective front and rear skid plates
- Front fog lights • Auto lighting/windscreen wipers
- Heated windscreen
- Electrically adjustable/heated door mirrors
- Electrically foldable door mirrors with puddle light
- Electrically operated front and rear windows
- Dark-tinted rear windows • Power tailgate

Safety/security:

- Switchable electronic stability programme
- Anti-lock braking system
- Safety Pack
 - Driver drowsiness system
 - Forward collision alert
 - Automatic emergency braking
 - Lane assist
- Side blind spot alert • Lane departure warning
- Speed sign recognition • Front camera system
- Traction control/hill start assist
- Deflation detection system • Six airbags
- Remote control central locking/alarm system
- Advanced park assist • 360° panoramic camera
- Emergency tyre inflation kit in lieu of spare wheel
- LED daytime running lights

GRANDLAND X PRICES

	Price (£)	VAT (£)	Total (£)	On-the-road RRP (£)	BiK 20% (£)	CO ₂ (g/km)
SE						
1.2 (130PS) Turbo S/S	19,175.00	3,835.00	23,010.00	23,935.00	110.63	121
1.2 (130PS) Turbo S/S auto	20,691.67	4,138.33	24,830.00	25,755.00	119.13	121
Diesel						
1.5 (130PS) Turbo D S/S	20,450.00	4,090.00	24,540.00	25,505.00	126.18	111
1.5 (130PS) Turbo D S/S 6-speed auto	21,950.00	4,390.00	26,340.00	27,305.00	135.18	111
DESIGN LINE						
1.2 (130PS) Turbo S/S	20,008.33	4,001.67	24,010.00	24,935.00	115.30	121
1.2 (130PS) Turbo S/S auto	21,525.00	4,305.00	25,830.00	26,755.00	123.80	121
Diesel						
1.5 (130PS) Turbo D S/S	21,283.33	4,256.67	25,540.00	26,505.00	131.18	113
1.5 (130PS) Turbo D S/S 6-speed auto	22,783.33	4,556.67	27,340.00	28,305.00	140.18	113
TECH LINE NAV						
1.2 (130PS) Turbo S/S	18,866.67	3,773.33	22,640.00	23,565.00	108.92	121
1.2 (130PS) Turbo S/S auto	20,383.33	4,076.67	24,460.00	25,385.00	117.40	121
Diesel						
1.5 (130PS) Turbo D S/S	20,133.33	4,026.67	24,160.00	25,125.00	124.28	113
1.5 (130PS) Turbo D S/S 6-speed auto	21,633.33	4,326.67	25,960.00	26,925.00	133.28	113
2.0 (177PS) Turbo D S/S auto	22,541.67	4,508.33	27,050.00	28,015.00	152.62	128

	Price (£)	VAT (£)	Total (£)	On-the-road RRP (£)	BiK 20% (£)	CO ₂ (g/km)
SPORT NAV						
1.2 (130PS) Turbo S/S	21,033.33	4,206.67	25,240.00	26,165.00	121.05	121
1.2 (130PS) Turbo S/S auto	22,550.00	4,510.00	27,060.00	27,985.00	129.53	121
Diesel						
1.5 (130PS) Turbo D S/S	22,308.33	4,461.67	26,770.00	27,735.00	137.33	113
1.5 (130PS) Turbo D S/S 6-speed auto	23,808.33	4,761.67	28,570.00	29,535.00	146.33	113
2.0 (177PS) Turbo D S/S auto	24,716.67	4,943.33	29,660.00	30,625.00	166.97	128
ELITE NAV						
1.2 (130PS) Turbo S/S	22,491.67	4,498.33	26,990.00	27,915.00	129.22	121
1.2 (130PS) Turbo S/S auto	24,008.33	4,801.67	28,810.00	29,735.00	137.70	121
Diesel						
1.5 (130PS) Turbo D S/S	23,758.33	4,751.67	28,510.00	29,475.00	146.05	113
1.5 (130PS) Turbo D S/S 6-speed auto	25,258.33	5,051.67	30,310.00	31,275.00	155.05	113
2.0 (177PS) Turbo D S/S auto	26,166.67	5,233.33	31,400.00	32,365.00	176.55	128
ULTIMATE						
Diesel						
2.0 (177PS) Turbo D S/S auto	28,308.33	5,661.67	33,970.00	34,935.00	190.68	128

S/S = Start/Stop.

All diesel models feature BlueInjection. Vehicles with BlueInjection technology will need regular AdBlue® top-ups also between servicing requirements. An indicator integrated into the on-board computer will warn you when you need to top up. More information see www.vauxhall.co.uk/adblue. In accordance with regulations R (EC) No. 715/2007 and R (EC) No. 692/2008 (in the versions respectively applicable).

Please note: On-the-road recommended retail prices (RRP) include number plates and delivery to retailer of £700.00 (inc. £116.67 VAT), 12 months' Vehicle Excise Duty and new vehicle first registration fee of £55.00. Excludes fuel and insurance. Company Car Benefit in Kind (BiK) rates are monthly based on the standard paint price.

STANDARD FEATURES

ALL MODELS

Driver/passenger airbags

- Driver's and front passenger's airbags
 - Front seat side-impact airbags
 - Full-size curtain airbags for driver, front seat passenger and outer rear seat passengers
-

Seating

- Height-adjustable front seat head restraints
 - Height-adjustable rear seat head restraints
 - Anti-submarining ramps in front seats
-

Seatbelts

- Inertia-reel lap and diagonal seatbelts for all seats
 - Dual seatbelt pretensioners on front seats – These keep the pelvis better coupled to the vehicle in an impact; the pelvis and therefore the legs are allowed less forward movement, reducing the risk of hard knee contact with the fascia
 - Pretensioners on outer rear seatbelt retractors
 - Load limiters on outer rear seatbelt retractors
 - Smart seatbelt reminder for front and rear seats – Warning lights and audible warning
-

Child safety

- Deactivation switch for front passenger's front and side-impact airbags – Permits the safe use of a child seat in the front passenger seat.
 - i-Size compatible child seat mountings located on front passenger's seat and outer rear seats (does not include child seat). Rear seat mountings incorporate top tether anchor points – Allows i-Size child safety seats to be securely fixed into the car. The mounting system reduces forward movement in an accident and makes the child seat easier to install
 - Child-proof locks on rear doors
-

Driver/passenger safety

- Energy-absorbing steering column
 - Side-impact protection beam
 - Reinforced passenger safety cell
 - Deformation zones front and rear
-

Pedestrian safety

- Collapsible windscreen wiper system – Designed to reduce pedestrian head injuries
 - Upper and lower bumper design – Reduces upper and lower leg injuries
-

Braking and stability

- Switchable Electronic Stability Programme (ESP)
 - Anti-lock Braking System (ABS)
 - Corner stability control
 - Traction control
 - Hill start assist
 - Engine drag torque control – Improves directional stability by preventing the driven wheels from locking on slippery surfaces under the influence of engine braking.
 - Hydraulic brake assist
 - Electronic brakeforce distribution.
-

Tyre pressure

- Deflation detection system
-

STANDARD FEATURES

ALL MODELS

Electric parking brake

- Centre console switch in lieu of handbrake lever
-

Steering

- Speed-sensitive electric power-assisted steering
-

Speed sign recognition

- Detects and then displays speed limits, reducing uncertainty and the risk of speeding.
 - Recognises different speed signs, including temporary speed restrictions
 - Displays reminder in the instrument cluster
 - On Nav models, where the front camera system is unable to detect any speed signs the speed limit stored in the navigation database will be displayed
-

Security features

- Remote control security alarm system (operates in conjunction with central locking)
 - Electronically protected audio equipment • Engine deadlock immobiliser
 - Visible Vehicle Identification Number (VIN) • Locking wheel nuts
 - Luggage compartment cover
-

Remote control central locking

- Operates on doors, tailgate and fuel filler flap • Deadlocking
 - Driver's internal central locking activation switch
-

Instrumentation

- Speedometer • Rev counter • Fuel gauge with low fuel level warning light
 - Water temperature gauge with warning light
 - Shift-up indication light (manual models only) – Indicates when to change gear for optimum fuel economy
-

Driver information display (centrally located in instrument cluster)

- Displays trip computer data • Total mileage • Service-due indicator
 - Deflation detection system • 3.5-inch colour information display
-

Multi-function trip computer (displayed on driver information display)

- Trip mileage • Vehicle range based on remaining fuel • Average speed
 - Average fuel economy • Instantaneous fuel economy
-

Central facia display (format dependent on infotainment unit)

- Audio information • Digital clock with automatic RDS time adjustment
 - Outside air temperature with ice warning function
 - Additional features dependent on infotainment unit (see infotainment for details)
-

Seating and comfort

- Reach and rake adjustable steering • Steering wheel mounted audio controls • Three-person layout
 - 60/40 split-folding rear seat • Height-adjustable and removable head restraints
 - Centre rear seat head restraint
-

Electronic climate control incorporating air conditioning

- Dual-zone control – Allowing different temperature settings for driver and front passenger.
 - Advanced predictive logic control system using a sun sensor
 - Charcoal filter – Removes dust, airborne particles, pollen and unpleasant odours
 - Automatic air direction and fan speed with manual override • Illuminated controls
-

Additional heating and ventilation features

- Four adjustable facia vents • Windscreen demist vents • Side window demist vents
 - Rear passenger compartment heating ducts • Heated rear screen with timed cut-off
-

Convenience features

- Front 12-volt electrical accessory socket • 12-volt electrical accessory socket in luggage compartment
 - Front and rear passenger assist handles • 220-volt power outlet behind front seats
 - Automatically dimming anti-dazzle rear-view mirror • Driver's centre armrest
-

STANDARD FEATURES

ALL MODELS

Interior lighting

- Courtesy lighting operated by door switches
-

Interior storage

- Ventilated glovebox with lid
 - Front door pockets with 2.6-litre capacity
 - Two drinks holders in centre console (one if optional All Road Pack is specified)
 - Rear door pockets with 1.8-litre capacity
 - Covered storage compartment in centre console and in driver's armrest
-

Luggage area

- Luggage compartment foldable cover
 - Fully carpeted luggage area
-

Exterior lighting features

- LED daytime running lights
 - Automatic lighting control
 - Lights-on audible warning
 - LED tail lights
 - High-level centre rear brake light
 - Rear fog light
 - Reversing light
 - Hazard warning lights
 - Door-to-door illumination
 - Welcome lighting
-

Front fog lights

Windscreen wipers

- Two-speed windscreen wipers with variable intermittent wipe
 - Intermittent rear window wash/wipe
 - Rain-sensitive windscreen wipers
-

Door mirrors

- Twin electrically adjustable/heated door mirrors (wide-angle on driver's side) with automatic timed cut-off – Mirrors automatically tilt downwards when reverse gear is selected to improve visibility of the back of the car
-

Windows

- Electrically operated front and rear windows with safety autoreverse and one-touch facility
 - Heated rear window
-

Sight and Light Pack

- Automatic lighting control
 - High beam assist
 - Rain-sensitive windscreen wipers
 - Automatically dimming anti-dazzle rear-view mirror
-

Body styling

- Side-protection mouldings
 - Chrome-effect front grille bar
 - Body-colour door mirrors
 - Body-colour door handles
 - Rear spoiler
-

Windows

- Sound-absorbing windscreen
 - Tinted windows
-

FEATURES/OPTIONS

DRIVER ASSISTANCE

	SE	Design Line	Tech Line Nav	Sport Nav	Elite Nav	Ultimate	Price (£) exc. VAT	Price (£) inc. VAT
<p>Cruise control with speed limiter and intelligent speed adaption</p> <p>The cruise control feature enables you to maintain a constant speed – making it ideal for economical motorway driving. The speed limiter function can be set to ensure that you do not exceed the speed limit and can be easily overridden if required. Working in conjunction with speed sign recognition, when a new speed limit is detected a message appears in the driver information display. You can then set the cruise control to the new speed limit with a simple press on a steering wheel button.</p> <ul style="list-style-type: none"> • Steering wheel mounted controls 	●	●	●	●	●			
<p>Automatic cruise control with speed limiter and intelligent speed adaption (only available on diesel automatic models)</p>			○	○	○	●	333.33	400.00
<p>All Road Pack</p> <hr/> <p>For those drivers who regularly take their vehicle off road, this pack helps the driver cope with whatever conditions they encounter</p> <hr/> <ul style="list-style-type: none"> • IntelliGrip: A choice of five selectable modes to suit the driving conditions: ESP on, ESP off, snow, mud, sand • 18-inch five-spoke alloy wheels with 225/55 tyres 	○						416.67	500.00
		○	○	○			166.67	200.00
					○	○	41.67	50.00
<p>Lane departure warning</p> <p>If the driver has not actively steered or signalled, the lane departure warning system warns when the car moves outside of lane markings at speeds above 37mph.</p> <ul style="list-style-type: none"> • Warning light in instrument cluster • Audible warning • Facia on/off switch 	●	●						
<p>Side blind spot alert</p> <p>Side blind spot alert helps prevent potential collisions with other vehicles ‘hidden’ in the vehicle’s side blind spots. If a vehicle enters one of the blind spots a warning light illuminates in the relevant door mirror.</p> <ul style="list-style-type: none"> • Ultrasonic side sensors with three-metre range • Warning light in door mirrors • Operates at speeds between 7mph and 70mph (where permitted) 			●	●	●	●		

● = Standard equipment. ○ = Optional at extra cost.

FEATURES/OPTIONS

DRIVER ASSISTANCE

	SE	Design Line	Tech Line Nav	Sport Nav	Elite Nav	Ultimate	Price (£) exc. VAT	Price (£) inc. VAT
<p>Safety Pack</p> <p>The front camera and radar systems combine to enhance the driver assistance and safety features.</p> <p>Driver drowsiness system The system monitors driving time and driving behaviour to help prevent accidents caused by tiredness.</p> <p>Forward collision alert with automatic emergency braking and pedestrian detection The system operates automatically from 3mph and gives an audible warning as well as a visual warning when approaching another vehicle too quickly. If no avoiding action is taken by the driver, at speeds below 19mph the system automatically slows the vehicle to a full stop with emergency braking of 0.9g. At speeds from 19mph to 70mph it brakes automatically to reduce speed by a maximum of 31mph – to reduce speed even further the driver must brake him/herself. The operational speed range of the system depends on the detected obstacle (mobile target: from 3 to 70mph; fixed target: from 3 to 50mph; pedestrian: from 3 to 37mph). Vauxhall driver assistance systems are intended to support the driver within the system-imminent limitations. The driver remains responsible for the driving task.</p> <p>Lane departure warning with lane assist When lane departure warning identifies an imminent lane departure without driver input, lane assist applies gentle steering corrections to keep the vehicle within its lane. The system operates from 40mph.</p>			●	●	●	●		
<p>Parking sensors • Rear parking distance sensors • Audible warning</p>	●							
<p>Park and Go Pack One</p> <p>An audible warning alerts you to obstacles in front of and behind you. A series of beeps are sounded as you approach the obstacle, increasing in frequency as the distance closes.</p> <p>• Front and rear parking distance sensors • Audible warning • Electrically foldable door mirrors with puddle light</p>	○	●	●	●	●		229.17	275.00

● = Standard equipment. ○ = Optional at extra cost.

FEATURES/OPTIONS

DRIVER ASSISTANCE CONTINUED

	SE	Design Line	Tech Line Nav	Sport Nav	Elite Nav	Ultimate	Price (£) exc. VAT	Price (£) inc. VAT
<p>Park and Go Pack Two</p> <hr/> <p>Advance park assist Advanced park assist not only detects suitable parking spaces but also expertly steers into them for you. All you have to do is to drive forward or reverse and brake. The system works with both parallel and bay parking.</p> <ul style="list-style-type: none"> • Front and rear parking distance sensors • Ultrasonic side sensors identify suitable parking spaces at speeds up to 12mph • Fully automated steering • Detailed forward/reverse instructions are shown in the instrument cluster. <hr/> <p>Rear view camera The rear view camera gives a clear view of the area behind the vehicle within the infotainment screen. The camera is mounted in the tailgate above the licence plate. The screen is activated by engaging reverse gear and remains while reverse is engaged.</p> <ul style="list-style-type: none"> • Activated when reverse gear selected • Camera view appears in infotainment screen • Rear bumper and grid lines shown as reference points 	○	○					541.67	650.00
<p>Park and Go Pack There</p> <hr/> <p>Advance park assist Advanced park assist not only detects suitable parking spaces but also expertly steers into them for you. All you have to do is to drive forward or reverse and brake. The system works with both parallel and bay parking.</p> <ul style="list-style-type: none"> • Front and rear parking distance sensors • Ultrasonic side sensors identify suitable parking spaces at speeds up to 12mph • Fully automated steering • Detailed forward/reverse instructions are shown in the instrument cluster <hr/> <p>360° panoramic camera The camera gives a clear view of the area all around your car and helps place the car perfectly, without needing to strain your neck.</p> <ul style="list-style-type: none"> • The 360° panoramic view detects traffic coming from the side, helping you reverse out of perpendicular parking spaces more safely • Overhead view allows you to see clearly how close you are to obstacles in front of and behind you • Activated when reverse gear selected, or when switched on manually • Camera view appears in infotainment screen • View switches automatically between front and rear based upon direction of travel • Rear bumper and grid lines shown as reference points 			○	○	○	●	687.50	825.00

● = Standard equipment. ○ = Optional at extra cost.

FEATURES/OPTIONS

SECURITY

	SE	Design Line	Tech Line Nav	Sport Nav	Elite Nav	Ultimate	Price (£) exc. VAT	Price (£) inc. VAT
Remote control central locking • Two folding keys each with integral remote control function	●	●	●	●	●			
Keyless entry/engine start/stop • Two keyless entry/start keys • Engine start/stop button • Power tailgate			○	○	○	●	591.67	710.00

INTERIOR STYLING

SE/Design Line interior décor Steering wheel: • Three-spoke design • Leather-covered • Satin chrome-effect bezel Facia and door trim: • Frosted silver facia and door panel inserts • Black door panels with black Modene cloth inserts • Chrome-effect interior door handles	●	●						
Tech Line Nav interior décor Steering wheel: • Three-spoke design • Leather-covered • Satin chrome-effect bezel Facia and door trim: • Toba grey facia and door panel inserts (with black trim) • Sanora gold facia and door panel inserts (with medium atmosphere trim) • Black door panels with black premium leather-effect inserts (with black trim) • Black door panels with medium atmosphere premium leather-effect inserts (with medium atmosphere trim) • Chrome-effect interior door handles Front door sill covers: • Alloy-effect			●					

● = Standard equipment. ○ = Optional at extra cost.

FEATURES/OPTIONS

INTERIOR STYLING CONTINUED

	SE	Design Line	Tech Line Nav	Sport Nav	Elite Nav	Ultimate	Price (£) exc. VAT	Price (£) inc. VAT
<p>Sport Nav interior décor</p> <p>Steering wheel:</p> <ul style="list-style-type: none"> • Three-spoke design • Leather-covered • Satin chrome-effect bezel <p>Facia and door trim:</p> <ul style="list-style-type: none"> • Toba grey facia and door panel inserts (with black trim) • Sanora gold facia and door panel inserts (with medium atmosphere trim) • Black door panels with black premium leather-effect inserts (with black trim) • Black door panels with medium atmosphere premium leather-effect inserts (with medium atmosphere trim) • Chrome-effect interior door handles <p>Front door sill covers:</p> <ul style="list-style-type: none"> • Alloy-effect 				●				
<p>Elite Nav/Ultimate interior décor</p> <p>Steering wheel:</p> <ul style="list-style-type: none"> • Three-spoke design • Leather-covered • Satin chrome-effect bezel <p>Facia and door trim:</p> <ul style="list-style-type: none"> • Toba grey facia and door panel inserts • Black door panels with black premium leather-effect inserts • Chrome-effect interior door handles Pedals: • Sports, alloy-effect – Ultimate models only. <p>Front door sill covers:</p> <ul style="list-style-type: none"> • Alloy-effect 					●	●		

● = Standard equipment.

FEATURES/OPTIONS

INFOTAINMENT

	SE	Design Line	Tech Line Nav	Sport Nav	Elite Nav	Ultimate	Price (£) exc. VAT	Price (£) inc. VAT
<p>R4.0 IntelliLink touchscreen infotainment system For use with media players, USB memory sticks, mobile phones and smartphone apps.</p> <p>Onboard features:</p> <ul style="list-style-type: none"> • 7-inch colour touchscreen • Digital radio/AM/FM stereo radio • RDS with Traffic Programme <p>Media connections</p> <ul style="list-style-type: none"> • USB connection with iPod control and smartphone projection • Bluetooth® A2DP audio streaming (Advanced Audio Distribution Profile) <p>Mobile phone portal:</p> <ul style="list-style-type: none"> • Bluetooth® connectivity • Handsfree calls via steering wheel controls • Vehicle microphone • Phone book access – Contacts/last calls/missed calls etc. are mirrored on IntelliLink's display and are easily navigated using the touchscreen (features dependent on mobile phone). <p>Smartphone interface:</p> <ul style="list-style-type: none"> • Apple CarPlay™ • Android Auto™ <p>Aerial:</p> <ul style="list-style-type: none"> • Rod antenna 	●	●						

● = Standard equipment.

FEATURES/OPTIONS

INFOTAINMENT CONTINUED

	SE	Design Line	Tech Line Nav	Sport Nav	Elite Nav	Ultimate	Price (£) exc. VAT	Price (£) inc. VAT
<p>Navi 5.0 IntelliLink touchscreen navigation and infotainment system</p> <p>For use with media players, USB memory sticks, mobile phones and smartphone apps.</p> <p>Onboard features:</p> <ul style="list-style-type: none"> • 8-inch colour touchscreen • Digital radio/AM/FM stereo radio • RDS with Traffic Programme • Embedded voice control <p>Navigation features:</p> <ul style="list-style-type: none"> • USB connection with iPod control and smartphone projection • Satellite navigation system • 3D street level mapping • European coverage <p>Media connections</p> <ul style="list-style-type: none"> • 2 USB connections, front with iPod control and smartphone projection functions • Bluetooth® A2DP audio streaming (Advanced Audio Distribution Profile) <p>Mobile phone portal:</p> <ul style="list-style-type: none"> • Bluetooth® connectivity • Handsfree calls via steering wheel controls • Vehicle microphone • Phone book access – Contacts/last calls/missed calls etc. are mirrored on IntelliLink's display and are easily navigated using the touchscreen (features dependent on mobile phone) <p>Smartphone interface:</p> <ul style="list-style-type: none"> • Apple CarPlay™ • Android Auto™ <p>Aerial:</p> <ul style="list-style-type: none"> • Shark fin 	○	○	●	●	●	●	591.67	710.00
<p>Denon premium sound system</p> <p>Only available with Navi 5.0. Not available with optional emergency spare wheel.</p> <ul style="list-style-type: none"> • Eight speakers • Subwoofer • Separate amplifier for subwoofer 			○	○	○	●	466.67	560.00
Six speakers (four front, two rear)	●	●	●	●	●			
Wireless charger for mobile devices	○	○	○	○	●	●	150.00	180.00

● = Standard equipment. ○ = Optional at extra cost.

FEATURES/OPTIONS

SEATING AND COMFORT



	SE	Design Line	Tech Line Nav	Sport Nav	Elite Nav	Ultimate	Price (£) exc. VAT	Price (£) inc. VAT
Cloth front seats Driver's seat (eight-way adjustable): • Height • Reach • Backrest • Head restraint Front passenger's seat (six-way adjustable): • Reach • Backrest • Head restraint Seat Trim: • Berson black fabric seat trim inserts • Modene black fabric side bolsters	●	●						
Ergonomic active front seats (AGR-approved*) Driver's and front passenger's seats (16-way adjustable): • Height • Reach • Tilt (electrical) • Backrest • Seat cushion extension • Lumbar adjustment (four-way electrical) • Head restraint Seat Trim: • Harlekin black fabric seat trim inserts • Black premium leather-effect side bolsters	○						437.50	525.00
• Harlekin medium atmosphere fabric seat trim inserts (not available on SE models) • Modene two-tone fabric inner side bolsters • Medium atmosphere premium leather-effect outer side bolsters			●	●				
			N/C	N/C			No cost option	
Ergonomic active front seats (AGR-approved*) and power driver's seat Driver's seat (16-way adjustable): • Height (electrical) • Reach (electrical) • Tilt (electrical) • Backrest (electrical) • Seat cushion extension • Lumbar adjustment (four-way electrical) • Head restraint • Active ventilation Front passenger's seat (16-way adjustable): • Height • Reach • Tilt (electrical) • Backrest • Seat cushion extension • Lumbar adjustment (four-way electrical) • Head restraint • Active ventilation Seat Trim: • Black Siena perforated leather seat trim inserts • Black Siena leather side bolsters					●	●		

*AGR (The Campaign for Healthier Backs) is an independent centre of excellence for ergonomics, based in Germany.

● = Standard equipment. ○ = Optional at extra cost. N/C = No-cost option.

FEATURES/OPTIONS

HEATING AND VENTILATION

	SE	Design Line	Tech Line Nav	Sport Nav	Elite Nav	Ultimate	Price (£) exc. VAT	Price (£) inc. VAT
Winter Pack One   • Heated front seats • Heated leather-covered steering wheel	○		○	○	●		295.83	355.00
Winter Pack Two   • Heated front seats (standard on Elite Nav) • Heated outer rear seats • Heated leather-covered steering wheel (standard on Elite Nav)			○	○	○	●	462.50 166.67	555.00 200.00

INTERIOR CONVENIENCE

Driver's and front passenger's sunvisors with vanity mirrors	●	●						
Driver's and front passenger's sunvisors with illuminated vanity mirrors			●	●	●	●		
Versatility Pack • 60/40 split-folding rear seat back • Centre rear seat armrest with ski pass-through • Illuminated luggage area • Flex Floor with under-floor divider	○	●	●	●	●	●	133.33	160.00

INTERIOR LIGHTING

Premium Lighting • Ambient centre console downlighter • Ambient lighting in front doors • Rear reading lights			●	●	●	●		
---	--	--	---	---	---	---	--	--

● = Standard equipment. ○ = Optional at extra cost.

FEATURES/OPTIONS

INTERIOR STORAGE

	SE	Design Line	Tech Line Nav	Sport Nav	Elite Nav	Ultimate	Price (£) exc. VAT	Price (£) inc. VAT
Interior storage <ul style="list-style-type: none"> Storage pocket on front seat backs – On SE models, fitted in conjunction with ergonomic sports front seats. Not available separately. 	☐		●	●	●	●		
Luggage area <ul style="list-style-type: none"> Illuminated luggage area – On SE models, fitted in conjunction with Versatility Pack. Not available separately. 	☐	●	●	●	●	●		
<ul style="list-style-type: none"> Flex Floor with under-floor divider – On SE models, fitted in conjunction with Versatility Pack. Not available separately. 	☐	●	●	●	●	●		

EXTERIOR LIGHTING

Standard lighting features Halogen headlights with manual beam levelling and high beam assist.	●	●	●	●	●			
Premium LED Adaptive Forward Lighting Pack LED elements light the road brighter than halogen, allowing you to see hazards sooner and giving you more time to react. The system uses data such as vehicle speed, steering angle and when the indicators are used to determine the most suitable lighting. <ul style="list-style-type: none"> Urban light – With street lighting and speeds up to 34mph, the system automatically enhances the dipped beam function. At speeds below 18mph the projector units swivel 8° outwards for improved visibility. Motorway light – At higher speeds, and with a low level of steering inputs, the light range is increased. Country light – At speeds between 34mph and 70mph the lighting is increased ahead and to the sides of the road. Static cornering light – At lower speeds, when you indicate and turn the steering above a certain angle, corners and bends are illuminated to match steering inputs. Dynamic curve light – The projector units swivel in the direction of travel based on steering angle and vehicle speed. Adverse weather light – The projector units swivel outwards to increase illumination of the side of the road and road signs, and to reduce the dazzling of oncoming traffic. Intelligent main beam control – Powerful down-the-road illumination on top of the LED low beam. Automatically switches between low beam and full beam based on traffic conditions. Automatic headlight levelling 	○	○	○	○	○	●	929.17	1,115.00

● = Standard equipment. ○ = Optional at extra cost. ☐ = Available as part of an extra-cost option pack.

FEATURES/OPTIONS

EXTERIOR CONVENIENCE

	SE	Design Line	Tech Line Nav	Sport Nav	Elite Nav	Ultimate	Price (£) exc. VAT	Price (£) inc. VAT
Door mirrors • Manually foldable door mirrors	●							
• Electrically foldable door mirrors with puddle light – Fitted as part of Park and Go Packs. Not available separately.	□	●	●	●	●	●		
Windows • Heated windscreen	○	○	○	○	●	●	87.50	105.00
• Dark-tinted rear windows		●	○	○	○	●	229.17	275.00
Fixed panoramic glass roof panel with electrically operated sunblind (not available in conjunction with silver-effect roof rails)	○	○	○	○	●	●	579.17	695.00
Roof rails, silver-effect (not available in conjunction with fixed panoramic glass roof panel)	○	○	○	○			125.00	150.00
Roof rails, silver-effect, in lieu of fixed panoramic glass roof panel					○	○	(457.17)	(545.00)
Power tailgate – Fitted as part of Keyless entry and start. Not available separately			□	□	□	●		
Detachable tow bar	○		○	○	○	○	583.33	700.00

EXTERIOR STYLING

Body styling • Alloy-effect protective front and rear skid plates		●	●	●	●	●		
• Chrome-effect side window upper trim		●	●	●	●	●		
• Gloss black B-pillars			●	●	●	●		
• Black roof and door mirrors (not available with Diamond Black or Amethyst Purple exterior colours)		●	○	●	○	●	333.33	400.00

● = Standard equipment. ○ = Optional at extra cost. □ = Available as part of an extra-cost option pack.

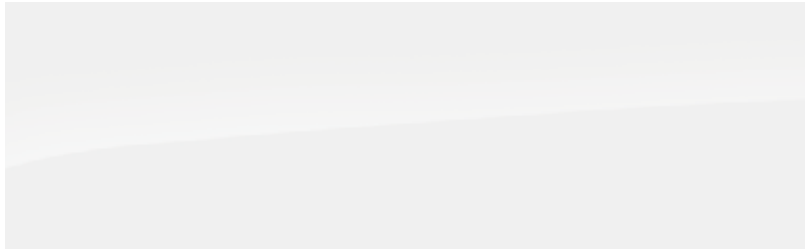

EXTERIOR COLOURS

		SE	Design Line	Tech Line Nav	Sport Nav	Elite Nav	Ultimate	Price (£) exc. VAT	Price (£) inc. VAT
Two-coat	 <p>Amethyst Purple premium</p> <ul style="list-style-type: none"> • Not available with black roof and door mirrors • On Sport Nav and Ultimate models black roof and door mirrors deleted 	○		○	○	○	○	620.83	745.00
Tri-coat	 <p>Pearl White premium</p>	○	○	○	○	○	○	625.00	750.00

The colours reproduced may vary slightly from the actual paint colour. As a result they should be used as a guide only. Your Vauxhall Retailer has a comprehensive display of our paint samples.

○ = **Optional at extra cost.**

WHEELS AND TYRES

	SE	Design Line	Tech Line Nav	Sport Nav	Elite Nav	Ultimate	Price (£) exc. VAT	Price (£) inc. VAT
18-inch steel emergency spare wheel (in lieu of emergency tyre inflation kit). Not available with optional premium sound system	○	○	○	○	○		91.67	110.00
 17-inch silver-effect five twin-spoke alloy wheels <ul style="list-style-type: none"> • 215/65 R 17 ultra low rolling resistance tyres • Emergency tyre inflation kit (in lieu of spare wheel) 	●							
 18-inch diamond-cut black five-spoke alloy wheels <ul style="list-style-type: none"> • 225/55 R 18 tyres • Emergency tyre inflation kit (in lieu of spare wheel) 		●						
 18-inch silver-effect multi-spoke alloy wheels <ul style="list-style-type: none"> • 225/55 R 18 tyres • Emergency tyre inflation kit (in lieu of spare wheel) 	○		●	N/C			416.67	500.00

● = Standard equipment. ○ = Optional at extra cost. N/C = No-cost option.

WHEELS AND TYRES

	SE	Design Line	Tech Line Nav	Sport Nav	Elite Nav	Ultimate	Price (£) exc. VAT	Price (£) inc. VAT
 <p>18-inch diamond-cut Technical Grey five-spoke alloy wheels</p> <ul style="list-style-type: none"> • 225/55 R 18 tyres • Emergency tyre inflation kit (in lieu of spare wheel) 				●				
 <p>18-inch five-spoke alloy wheels</p> <ul style="list-style-type: none"> • 225/55 R 18 tyres • Emergency tyre inflation kit (in lieu of spare wheel) • Fitted as part of All Road Pack. Not available separately • CO₂ emissions will increase on SE models 	□	□	□	□	□	□		
 <p>19-inch diamond-cut five twin-spoke alloy wheels</p> <ul style="list-style-type: none"> • 235/50 R 19 tyres • Emergency tyre inflation kit (in lieu of spare wheel) 					●	●		

● = Standard equipment. ○ = Optional at extra cost. □ = Available as part of an extra-cost option pack.

PERFORMANCE, FUEL ECONOMY AND EMISSIONS

	Performance (manufacturer's figures)			Fuel economy mpg (litres/100km)#		CO ₂ emissions g/km*	Vehicle Excise Duty**		Benefit in kind company car taxation rates - 2019/20 tax year
	Wheel size (inches)	Maximum speed (mph)	Acceleration 0-60mph (sec)	Combined Low	Combined High		First year rate	Standard rate	
Petrol models†									
1.2 (130PS) Turbo S/S	17	117	9.5	39.8 (7.1)	43.5 (6.5)	121	£170	£145	28%
1.2 (130PS) Turbo S/S	18/19	117	9.5	39.8 (7.1)	43.5 (6.5)	121	£170	£145	28%
1.2 (130PS) Turbo S/S automatic	17	122	9.8	37.2 (7.6)	40.9 (6.9)	121	£170	£145	28%
1.2 (130PS) Turbo S/S automatic	18/19	122	9.8	37.2 (7.6)	40.9 (6.9)	121	£170	£145	28%
Diesel models									
1.5 (130PS) Turbo D S/S BlueInjection	17	119	10.2	48.7 (5.8)	53.3 (5.3)	111	£210	£145	30%
1.5 (130PS) Turbo D S/S BlueInjection	18/19	119	10.2	48.7 (5.8)	53.3 (5.3)	113	£210	£145	30%
1.5 (130PS) Turbo D S/S 6-speed automatic BlueInjection	17	119	9.9	44.8 (6.3)	54.3 (5.2)	111	£210	£145	30%
1.5 (130PS) Turbo D S/S 6-speed automatic BlueInjection	18/19	119	9.9	44.8 (6.3)	54.3 (5.2)	113	£210	£145	30%
2.0 (177PS) Turbo D S/S automatic BlueInjection	18/19	131	8.9	42.8 (6.6)	46.3 (6.1)	128	£210	£145	33%

S/S = Start/Stop.

All diesel models feature BlueInjection, see www.vauxhall.co.uk/adblue.

#Fuel consumption figures are determined according to the WLTP test cycle. Full data relating to WLTP test cycles can be found at: www.vauxhall.co.uk/wltp

*CO₂ emissions figures are determined according to the WLTP test cycle however, a Government formula is then applied to translate these figures back to what they would have been under the outgoing NEDC test cycle, which WLTP replaces. The correct tax treatment is then applied.

Figures are intended for comparability purposes only. The fuel consumption you achieve under real life driving conditions and CO₂ produced will depend upon a number of factors, including the accessories fitted after registration, variations in driving styles, weather conditions and vehicle load. Only compare fuel consumption and CO₂ with other vehicles tested using the same technical procedures. For more information contact your local Vauxhall Retailer.

**Correct at time of publication.

†Provisional data.

DIMENSIONS

Loadspace Dimensions

Maximum length (behind rear seats)	873 (34.4)
Maximum length (rear seats folded)	1696 (66.8)
Maximum width	1053 (41.5)
Maximum height	866 (34.1)

Luggage Capacities* litres (cu.ft.)

Rear seats up (under luggage compartment cover)	514 (18.1)
Rear seats folded (to roof)	1652 (58.3)

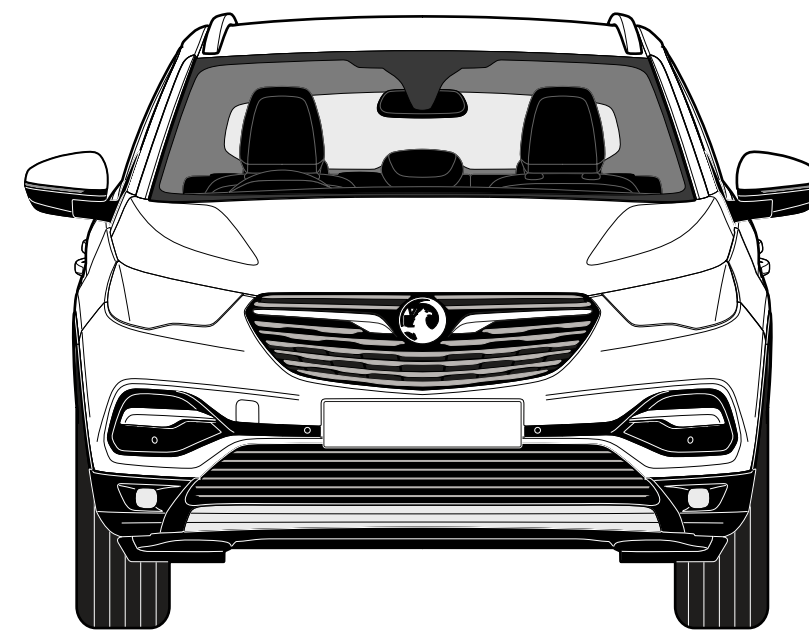

1856 (73.1)
excluding door mirrors

2098 (82.6)
including door mirrors

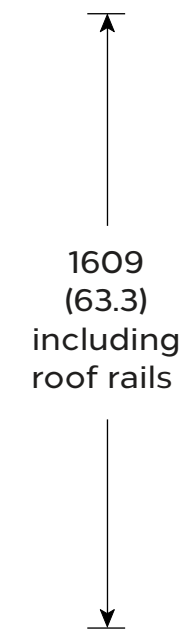

1609
(63.3)
including
roof rails

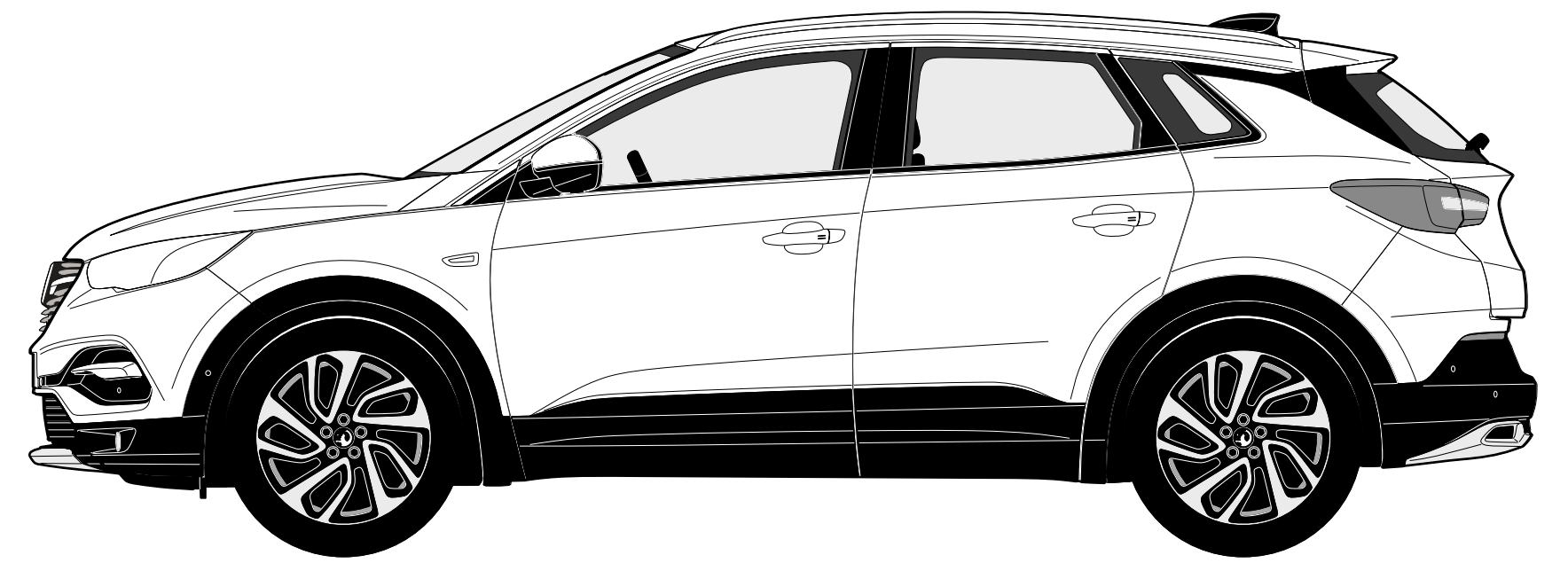

933
(36.7)

2675 (105.3)

869
(34.2)

4477 (176.3)

GRANDLAND X

All measurements are in mm (inches) unless stated otherwise.

*Measured using the ECIE method.

SPECIFICATIONS

Start/Stop technology

Grandland X's Start/Stop system, fitted as standard to all models, offers real benefits by improving fuel economy and reducing CO₂ emissions, particularly in town. It does this by automatically stopping the engine when you come to a standstill, and then restarting as you prepare to move off.

Before automatically stopping the engine a number of system checks are carried out to ensure that it is both safe and practical to do so. To ensure safety, the driver must depress the clutch pedal, shift in to neutral, and then release the clutch pedal. System checks carried out before Auto Stop activates include:

- Start/Stop system is not manually deactivated via the facia button
- Sufficient brake vacuum is available to prevent the car rolling down an incline
- Battery is in good condition and charged
- Outside air temperature and engine temperature are above specified minima
- Electronic climate control (where fitted) is not in maximum heating or maximum cooling mode
- Self-cleaning function of the diesel particulate filter is not active

If all of these conditions are satisfied then the vehicle will Auto Stop.

When you are ready to pull away from standstill, Auto Restart is activated by depressing the clutch pedal.

Whilst at a standstill the vehicle is continually monitored. If necessary, the engine will automatically be restarted. Conditions that would initiate an Auto Restart include:

- Low battery level
- Brake vacuum below specified minimum
- Start/Stop system is manually deactivated
- Stationary for 5.5 minutes

Fuel tank capacity

- 53 litres (11.6 gallons)

Adblue tank capacity

- 17 litres (3.7 gallons)

Transmissions

Six-speed manual gearbox:

Standard on all models except Ultimate.

Six-speed automatic transmission with

Active Select function:

Available at extra cost on all models except Ultimate. Electronically controlled with adaptive driving function and fuel-saving eco mode. Fluid drive with torque converter, lock-up clutch and Active Select.

Eight-speed automatic transmission:

Standard on Ultimate models.

Available at extra cost on all other models.

Steering

- Speed-sensitive electric power-assisted steering

Suspension

Front: Independent. Decoupled MacPherson struts with gas-pressure dampers and coil springs. Anti-roll bar.

Rear: Compound crank with coil springs and gas-pressure dampers.

Braking and stability

- Switchable Electronic Stability Programme (ESP)
- Anti-lock Braking System (ABS)
- Corner stability control
- Traction control
- Hill start assist
- Hydraulic brake assist
- Electronic brakeforce distribution

All models

Front ventilated discs: 304mm diameter

Rear discs: 268mm diameter

Weights and Towing Data kg

	Gross vehicle weight	Maximum towing weights Trailer with brakes (without brakes)
1.2 (130PS) Turbo Start/Stop	1900	1400 (685)
1.2 (130PS) Turbo Start/Stop auto	2000	1300 (696)
1.5 (130PS) Turbo D Start/Stop	2000	1500 (715)
1.5 (130PS) Turbo D Start/Stop 6-speed auto	2000	1300 (727)
2.0 (177PS) Turbo D Start/Stop auto	2090	2000 (750)

Gross vehicle weight is the total permissible weight of the vehicle including passengers and their luggage. The **maximum roof rack loading** should not exceed 75kg on all models. The **maximum towing weights** are based on the ability of the car, with two occupants of 75kg each, to restart on a 12% gradient, which is approximately 1 in 8.3, at sea level. The permitted trailer load applies up to the specified incline and up to an altitude of 1000 metres above sea level. The permissible gross train weight decreases by 10% for every 1000 metres of additional altitude. Any extra weight, such as luggage or additional passengers, should be deducted from the maximum towing weight. With a trailer fully loaded, **maximum noseweight** should not exceed 75kg. Always fit Vauxhall towing attachments and accessories available from your Vauxhall Retailer. They are designed specifically for Vauxhall models and carry a 12-month guarantee. During trailer towing do not exceed a maximum speed of 60mph. This speed limit is also applicable in countries with higher permitted speeds for trailer-vehicle combinations. Pay attention to the local speed limits. For trailers with low driving stability and caravans the use of an oscillation damper is strongly recommended.

PETROL ENGINE

Engine	1.2 (130PS) Turbo
Capacity	1199cc
Maximum power	130PS (96kW) @ 5500rpm
Maximum torque	230Nm (169 lb.ft.) @ 1750rpm
Configuration	3 cylinders, 4 valves per cylinder, double overhead camshafts
Fuel/induction system	Turbocharger. Variable Valve Timing. Common rail direct injection
Emission compliance	Euro 6d-TEMP (6.3)
Service interval	16,000 miles or 1 year (whichever occurs sooner)

DIESEL ENGINES

Engine	1.5 (130PS) Turbo D	2.0 (177PS) Turbo D
Capacity	1499cc	1997cc
Maximum power	130PS (96kW) @ 5500rpm	177PS (130kW) @ 3750rpm
Maximum torque	300Nm (221 lb.ft.) @ 1750rpm	400Nm (295 lb.ft.) @ 2000rpm
Configuration	4 cylinders, 4 valves per cylinder, double overhead camshafts	4 cylinders, 4 valves per cylinder, double overhead camshafts
Fuel/induction system	Turbocharger with intercooler. Common rail direct injection	Turbocharger with intercooler. Common rail direct injection
Emission compliance	Euro 6d-TEMP (6.2). Diesel Particulate Filter	Euro 6d-TEMP (6.2). Diesel Particulate Filter
Service interval	16,000 miles or 1 year (whichever occurs sooner)	16,000 miles or 1 year (whichever occurs sooner)

ACCESSORIES

CHILD SEATS¹	Total (inc. VAT)
BABY-SAFE ² – 0-13kg/birth to 15 months	£141
– ISOFIX base	£244
DUO ISOFIX ² – 9-18kg/9 months to 4 years	
with top tether kit	£372
KID ² – 15-36kg or 4 to 12 years	£168
SAFETY	
Parking sensors	
– four fully flush rear bumper mounted sensors	£365
– four fully flush front bumper mounted sensors ³	£358
Rear view camera	£327
Alarm system	£409
Safety Pack – first aid kit, hi-visibility vest and small warning triangle	£30
Warning triangle – Small	£12
Warning triangle – Large	£20
First aid kit	£15
Hi-visibility vest	£9
Fire extinguisher – 2kg	£39
FLEXCONNECT RANGE	
FlexConnect bracket	£22
FlexConnect hook	£32
FlexConnect coat hanger	£34
FlexConnect folding table	£77
FlexConnect iPad Mini cradle	£109
FlexConnect iPad (1-4) cradle	£118
FlexConnect iPad Air cradle	£117
FlexConnect Samsung Galaxy cradle	£107

PRACTICAL	Total (inc. VAT)
Spare bulb kit ³	£28
Stretch tow rope – 3 tonne	£36
Smoker pack	£44
Side steps	£503
PROTECTION	
Rubber floor mats – set of four	£49
Velour floor mats – set of four	£59
Economy froot mats – set of four	£33
Cargo liner ⁴	£71
Dog guard (fitted)	£202
Mudflaps – front and rear	£101
Load compartment mat	£107

TRANSPORT SYSTEMS	Total (inc. VAT)
Roof base carrier	from £197
Roof carriers (requires base carrier)	
Bike roof carrier – Thule Freeride 532	£78
Surf board roof carrier – Thule 833	£82
Kayak roof carrier – Thule 837	£172
Ski roof carrier (up to 4 pairs)	
– Thule 7324	£161
Ski roof carrier (up to 6 pairs)	
– Thule 7326	£190
Hard shell roof boxes (requires base carrier)	
Thule Ocean 80 (320 litre/1330 x 860 x 370mm)	£154
Thule Ocean 200 (450 litre/1750 x 820 x 450mm)	£323
Thule Motion 800 (460 litre/2050 x 840 x 450mm)	from £463
Thule Touring 200 (400 litre/1750 x 820 x 450mm)	£338
Thule Touring 700 (430 litre/2320 x 700 x 420mm)	£384
Tow bar carrier system	
Fixed tow bar ⁵	from £436
Detachable tow bar ⁵	from £572

STYLING	Total (inc. VAT)
Stainless steel pedal covers	
– manual	£65
– automatic	£57

Please note: Prices shown are fully fitted and painted, where applicable and include VAT. Please check with your local Vauxhall Retailer for details. It is advisable to ensure your insurance policy is adequate to cover additional fitted accessories. Prices correct at time of publication.

¹Restrictions apply to the use of child seats, please consult your Vauxhall Retailer or request a copy of the Child seats brochure. ²Without transponder. ³Excludes xenon headlight bulb for models with Adaptive Forward Lighting (AFL). ⁴Not available with Flex Floor option.

⁵Available with 7 pin, 13 pin and 12S electrics. Please consult your Vauxhall Retailer for details.

COMPANY CAR DRIVER AND FLEET INFORMATION

Design and Tech Line High Spec Low P11D

Specifically developed for businesses and company car drivers alike, our Design and Tech Line Nav models are seriously fit for Fleet.

Design models all feature very low P11D values, generous standard specification, including Sat Nav on Design Nav models, and a choice of high tech ecoTEC engines for great fuel economy and low emissions.

For even more standard specification, step up to our Tech Line Nav range. Again you are guaranteed low P11D values, plus great standard kit including Sat Nav, Bluetooth®, USB connection, aux-in socket and digital radio.

With Design and Tech Line Nav you can take for granted low Whole Life Costs and low company car driver taxation.

Company Car Driver Free 3 Day Test Drive

Our free* 3 Day Test Drive programme is open to all Company Car Drivers which allows you to choose any model in the current Vauxhall line-up (exclusions apply). With full insurance cover provided, it gives you a meaningful length of time to make an informed decision about your next company car.

Search Vauxhall 3DTD to book your FREE* test drive or click the link the below:

[Vauxhall 3 Day Test Drive](#)

*The free 3 Day Test Drive programme is open to Company Car Drivers and Fleet Decision Makers. Available for UK Mainland only. Terms and conditions apply. Full terms and conditions can be found at vauxhallfleet.co.uk/testdrive/index/terms.

Benefit in kind company car taxation†

The car benefit charge will be the car's list price (including VAT, options and accessories fitted, delivery to Retailer and number plates, but excluding Vehicle Excise Duty and new vehicle first registration fee) multiplied by the percentage charge for the CO₂ emissions band in which the car falls (see table opposite). Multiply this figure by your personal income tax rate (20%^{††} for Basic Rate, 40%^{††} for Higher Rate) to calculate your annual benefit in kind tax liability.

Example:

Grandland X Tech Line Nav 1.5 (130PS) Turbo D Start/Stop (CO₂ emissions 113g/km)

On-the-road RRP	£25,125.00
Deduct: Vehicle Excise Duty	(£210.00)
New vehicle first registration fee	(£55.00)
Effective list price	£24,860.00
Add: Optional two-coat metallic paint	£570.00
List price for tax purposes (P11D value)	£25,430.00
Car benefit charge 2019–20 tax year (30%)	£7,629.00
Benefit in kind tax liability (2019–20 tax year)	
Basic Rate (20%) tax payer	£ 1,525.80
Higher Rate (40%) tax payer	£3,051.60

†Please note this Price Guide provides taxation information as a guide only. Vauxhall does not provide taxation guidance. Drivers should always take professional advice on their own tax position.

††Excludes residents of Scotland.

BIK FOR SCOTTISH RESIDENTS

Effective 6 April 2018 the Scottish Government have introduced their own BIK taxation structure. This only applies to Company Car Drivers that are Scottish taxpayers. HMRC will determine whether or not an individual is a Scottish taxpayer based on where their main place of residence is.

The BIK rates for Scotland are:

- Over £12,500–£14,549 Starter Rate 19%
- Over £14,549–£24,994 Basic Rate 20%
- Over £24,994–£43,430 Intermediate Rate 21%
- Over £43,430–£150,000 Higher Rate 41%
- Above £150,000 Top Rate 46%

Benefit in kind company car taxation table

CO ₂ emissions in grams per kilometre	Percentage of cars price to be taxed	
	Non-Diesel [#] 2019-20 tax year	Diesel ^{##} 2019-20 tax year
Up to 50	16	20
51-75	19	23
76-94	22	26
95-99	23	27
100-104	24	28
105-109	25	29
110-114	26	30
115-119	27	31
120-124	28	32
125-129	29	33
130-134	30	34
135-139	31	35
140-144	32	36
145-149	33	37
150-154	34	37
155-159	35	37
160-164	36	37
165-169	37	37
170-174	37	37
175-179	37	37
180 and above	37	37

[#]Also applies to diesel vehicles that meet the Real Driving Emissions Step 2 (RDE2). ^{##}Applies to vehicles that do not meet the Real Driving Emissions Step 2 (RDE2).

To calculate your own personal liability, search: **Vauxhall BiK**, or click the link below: [Vauxhall BiK Tool](#)

Fleet Toolbox

Discover the facts in our online Toolbox for both Company Car Drivers and Fleet Decision Makers. The Fleet Toolbox has a host of useful calculators, comparators, interactive listings and information.

Search Vauxhall Fleet Tools or click the link below:

[Vauxhall Fleet Tool Box](#)

Contact Vauxhall Fleet

Please contact one of our dedicated sales teams who will be happy to help with your particular enquiry.

Company Car Drivers

Call: 0345 111 2020

Email: company-car@vauxhallinfo.co.uk

Telephone lines are open

– Monday to Friday 8:00am–9:00pm

– Saturday and Sunday 9:00am–6:00pm

Fleet Decision Makers

Depending on the size of your fleet of vehicles, we have a dedicated team to handle your enquiries. The lines are open Monday to Friday excluding Bank Holidays.

1-24 vehicles

Call: 0845 076 2254 (8:30am–5:00pm)

25+ vehicles

Call: 0330 587 8222 (8:30am–5:00pm)

Email: vauxhallfleet@vauxhall.co.uk

Special Vehicles (Police, Fire and Ambulance)

Call: 01582 409999 (8:30am–5:00pm)

Email: vauxhallspecialvehicles@vauxhall.co.uk

For more information visit www.vauxhall.co.uk/fleet

FURTHER INFORMATION

On-the-road prices

To eliminate uncertainty about hidden costs when buying a new car, Vauxhall publishes on-the-road recommended retail prices (RRP) and these are shown in the pricing tables within this price guide. These prices include VAT, number plates and delivery to Retailer of £700.00 (including £116.67 VAT), 12 months' Government Vehicle Excise Duty (see opposite for details) and the DVLA new vehicle first registration fee of £55.00.*

Please note: The on-the-road recommended retail price (RRP) does not include fuel supplied by the Retailer, motor insurance or any other goods or services supplied by agreement between the Retailer and the customer.

Price protection

Order a new Vauxhall for build in the current model year (as confirmed by your Retailer) for delivery no more than three months in advance and the price you are quoted is the price you pay. This is irrespective of any subsequent price rises between placing your order and delivery of your new car, but you must take delivery as soon as the car is available. Vauxhall Motors Limited is not liable for price adjustments caused by Government changes in the rate of VAT (currently 20%), Vehicle Excise Duty, DVLA new vehicle first registration fee or by any other applicable legislation or regulations.

Vauxhall Finance Leasing

Vauxhall Finance Leasing is a trading style of Vauxhall Finance plc. Working with the Vauxhall Retailer network we provide competitive car and van leasing solutions for business users and private individuals. We combine the support of a national contract with the convenience of a local contact.

For further information, please contact your local Vauxhall Retailer or visit www.vauxhall.co.uk/leasing

In the event of an accident

Vauxhall Accident Management helps keep you mobile following an accident. Benefits include vehicle recovery, Vauxhall-approved repairs and contacting your insurer. For more details, visit www.vauxhall.co.uk/AccidentManagement

Vehicle Excise Duty

The amount of Vehicle Excise Duty (road fund licence) payable on new cars varies depending on the level of carbon dioxide (CO₂) emissions produced by the vehicle. CO₂ emissions are measured in grams per kilometre (g/km) travelled and divided into 13 charging bands shown in the table opposite.

A 'first year rate' of Vehicle Excise Duty is payable on all new cars and in subsequent years the amount payable reverts to the 'standard rate'. From 1 April 2017 the breakpoints for each of these bands have been revised. Also, for vehicles with a list price over £40,000, including factory-fitted options, an additional £320 is payable for the first five years of standard rate payments.

Vehicle Excise Duty*

Band	CO ₂ emissions in grams per kilometre	First year rate		Standard rate
		Petrol [#]	Diesel [†]	
A	0	£0	£0	£0
B	1-50	£10	£25	£145
C	51-75	£25	£110	£145
D	76-90	£110	£130	£145
E	91-100	£130	£150	£145
F	101-110	£150	£170	£145
G	111-130	£170	£210	£145
H	131-150	£210	£530	£145
I	151-170	£530	£855	£145
J	171-190	£855	£1,280	£145
K	191-225	£1,280	£1,815	£145
L	226-255	£1,815	£2,135	£145
M	over 255	£2,135	£2,135	£145

*Correct at time of publication.

[#]Also applies to diesel vehicles that meet the Real Driving Emissions Step 2 (RDE2).

[†]Applies to vehicles that do not meet the Real Driving Emissions Step 2 (RDE2).

FURTHER INFORMATION

Customer Care Commitment

For added peace of mind, Vauxhall has an innovative Customer Care Commitment that offers the following:

- Three-year vehicle warranty consisting of a one-year/unlimited mileage manufacturer's warranty and a second and third year manufacturer's warranty with a 60,000 miles limitation
- Vauxhall Assistance for 12 months from first registration
- Six years' body panel anti-perforation warranty

Please note: Warranty is only available on vehicles sourced from Vauxhall Motors Limited. Terms and conditions apply – please see your Vauxhall Retailer for details.

Vauxhall Assistance

Vauxhall Assistance is provided automatically with every new Vauxhall for 12 months from first registration and covers everything from accident assistance, roadside recovery and 'at home' service to flat tyres. With Vauxhall Assistance help is literally just a free* phone call away, 24 hours a day, 365 days a year!

Protecting the environment

Vauxhall's commitment to the environment is demonstrated by our products' many environmental awards. For even more information on Vauxhall's efforts to achieve an environmentally sustainable future, and how to dispose of your end-of-life vehicle, see www.vauxhall.co.uk/recycling

Vauxhall Service Plan

- Fixed monthly payments for the plan duration
- Easy to budget and interest-free
- Genuine parts fitted by Vauxhall-trained technicians

Plus on Gold plans:

- Valet and courtesy car
- Vauxhall Roadside Assistance
- Engine flush and fuel treatments
- Litre of oil for top ups between services

Full details can be obtained from your local participating Vauxhall Retailer.

Vauxhall Insurance with added reassurance

Comprehensive cover – Summary of benefits**

- Competitive premiums
- Repairs by a Vauxhall-trained technician
- Genuine Vauxhall parts, guaranteed for three years when we repair your car within our Approved Repairer Network
- Free courtesy car as standard when using an Approved Repairer†
- 24 hour claims helpline
- Personal Accident benefit
- Cover for audio equipment
- Windscreen cover

Call for a quote on **0844 463 2670**††

For more product information

For further information on the Vauxhall range or location of your nearest Vauxhall Retailer please call **0345 600 1500**. Alternatively, details can be found on our website at www.vauxhall.co.uk

*Mobile phone users will be charged at their standard tariff.

**The benefits listed above are for comprehensive cover only. For details of Third Party, Fire and Theft cover, please call our sales team.

†Should your car need repairing following an accident we provide a courtesy car (subject to availability) for the duration of the repair. Only genuine Vauxhall parts are used. Terms and conditions apply.

††Calls may be recorded. Vauxhall Insurance is underwritten by Ageas Insurance Limited.

Take the next step:



Join us online:

Discover the full Vauxhall range at [vauxhall.co.uk](https://www.vauxhall.co.uk) >

Privacy Policy: For full details please visit [vauxhall.co.uk/privacy](https://www.vauxhall.co.uk/privacy)

The invoice price, including delivery to Retailer, factory-fitted options, accessories fitted by the Retailer and number plates, is subject to VAT. Some feature descriptions in this guide may refer to, and some illustrations may show, optional equipment not included in the standard delivery. The information contained in this guide was accurate at the time of publication. We reserve the right to make changes in design and equipment. Please note that Vauxhall Retailers are not the agents of Vauxhall Motors Limited and are not authorised to bind Vauxhall Motors Limited by any specific or implied undertaking or representation. It is advisable to ensure that your motor insurance policy provides adequate cover for additional fitted options and accessories. The colours in this guide are only approximate actual colours. Illustrated optional equipment is available at extra charge. Availability, technical features and equipment provided on our vehicles can vary by model. For precise information on the equipment provided on our vehicles, please contact your local Vauxhall Retailer.

NEW COMBO LIFE

Price and Specification Guide | 1 April 2019 | Model Year 2019.5



Best Buy Car
2019



VAUXHALL
British Brand since 1903

CONTENTS

To find the information you want use the links below to navigate around the guide:

[RANGE HIGHLIGHTS >](#)

Explore the New Combo Life range and find your perfect

[MODELS >](#)

Find all the information you need about your chosen model.

[PRICES >](#)

Find on-the-road recommended retail prices.

[FEATURES/OPTIONS >](#)

Tailor your chosen model to suit your needs with everything from satellite navigation to rear-view camera and parking sensors.

[EXTERIOR COLOURS >](#)

Add some sparkle to your car with a metallic paint.

[WHEELS AND TYRES >](#)

Why not upgrade to a set of distinctive alloy wheels to give your car more presence.

[PERFORMANCE, FUEL ECONOMY AND EMISSIONS >](#)

Know how many miles you will get around town, the CO₂ figures and the 0-60 time.

[DIMENSIONS >](#)

Ensure your car will fit in the garage and know how much luggage you can take for a long weekend away.

[SPECIFICATIONS >](#)

Towing weights, engine details and other useful details you may need to know.

[ACCESSORIES >](#)

Add some practical touches to your car with our range of quality accessories.

[COMPANY CAR INFORMATION >](#)

Benefit in Kind company car tax, 3 day test drives and P11D.

[FURTHER INFORMATION >](#)

Price protection, vehicle excise duty, our range of additional products and much more.

COMBO LIFE RANGE HIGHLIGHTS



DESIGN OTR from £20,135

Standard features include:

Infotainment:

- AM/FM/DAB digital radio, Bluetooth®, USB audio connection with four speakers

Interior:

- Height-adjustable driver's seat
- 60/40 split-folding rear seat back
- Air conditioning
- Steering wheel mounted audio controls
- 3.5-inch colour display

Exterior:

- Electrically adjustable/heated door mirrors
- Electrically operated front windows
- Nearside and offside sliding side-access door with opening windows
- Daytime running lights
- Tailgate with heated rear window and wiper
- Body-colour front and rear bumpers
- Side protection mouldings
- Emergency tyre inflation kit

Safety/security:

- Automatic emergency braking with pedestrian detection
- Electronic stability programme with traction control
- Forward collision alert
- Lane keep assist with lane departure warning
- Automatic lighting control
- Keyless entry and start (on automatic models)
- Cruise control with speed limiter
- Speed sign recognition
- Six airbags • Driver drowsiness system

ENERGY OTR from £21,535

Features over Design:

Infotainment:

- Touchscreen infotainment system
- 8-inch colour touchscreen

Interior:

- Chrome-effect instrument rings
- Chrome-effect interior door handles
- Luggage compartment cover

Exterior:

- Body-colour exterior door mirrors and handles
- Front and rear parking sensors
- Front fog lights
- 16-inch alloy wheels with 205/60 R16 tyres
- Automatic windscreen wipers
- High beam assist
- Body-colour side protection mouldings

7-SEAT OTR from £22,235

7-seat models additionally feature:

- 35/30/35 split-folding second-row seats with fold-flat facility
- Two individual split-folding and removable third-row seats
- Sliding facility for third row seats (XL models only)
- Front-seat back pockets
- Two foldable tables with cupholders

DESIGN



DESIGN ON-THE-ROAD PRICES

	5-seat MPV		Insurance Group
	OTR RRP	CO ₂ (g/km)	
Petrol			
1.2 (110PS) Turbo S/S	£20,135	125	8E
Diesel			
1.5 (100PS) Turbo D S/S BlueInjection	£20,665	111	8E – 9E
1.5 (130PS) Turbo D S/S automatic BlueInjection	£23,185	114	12E

DESIGN XL ON-THE-ROAD PRICES

Petrol			
1.2 (110PS) Turbo S/S	£21,035	125	8E
Diesel			
1.5 (100PS) Turbo D S/S BlueInjection	£21,565	113	8E – 9E

Please note: On-the-road recommended retail prices (RRP) include VAT at 20%, number plates and delivery to Retailer of £700.00 (inc. £116.67 VAT), 12 months' Vehicle Excise Duty and new vehicle first registration fee of £55.00. Excludes fuel and insurance.

S/S = Start/Stop.

FEATURES

Infotainment:

- AM/FM/DAB digital radio, Bluetooth® audio streaming, Bluetooth® mobile phone portal, USB audio connection
- 3.5-inch colour display
- Four speakers

Interior convenience/styling:

- Height-adjustable driver's seat
- Air conditioning
- Steering wheel mounted audio controls
- 60/40 split-folding rear seat back

Exterior convenience/styling:

- Keyless entry and start – Standard on automatic models only.
- Electrically adjustable/heated door mirrors
- Electrically operated front windows with safety autoreverse and one-touch up/down facility
- Nearside and offside sliding side-access door with opening windows
- Daytime running lights
- Tailgate with heated rear window and wiper
- Body-colour front and rear bumpers
- Moulded side-protection mouldings
- 16-inch steel wheels with 205/60 R16 tyres
- Full-diameter wheel covers
- Emergency tyre inflation kit

Safety/security:

- Automatic emergency braking with pedestrian detection
- Electronic stability programme with traction control
- Anti-lock braking system
- Forward collision alert
- Emergency brake assist
- Lane keep assist with lane departure warning
- Automatic lighting control
- Cruise control with speed limiter
- Speed sign recognition
- Six airbags
- Driver drowsiness system

ENERGY



ENERGY ON-THE-ROAD PRICES

	5-seat MPV		7-seat MPV		Insurance Group
	OTR RRP	CO ₂ (g/km)	OTR RRP	CO ₂ (g/km)	
Petrol					
1.2 (110PS) Turbo S/S	£21,535	125	£22,235	125	8E
Diesel					
1.5 (100PS) Turbo D S/S BlueInjection	£22,065	111	£22,765	115	8E – 9E
1.5 (130PS) Turbo D S/S BlueInjection	£23,185	114	-	-	12E
1.5 (130PS) Turbo D S/S automatic BlueInjection	£24,585	114	-	-	12E

ENERGY XL ON-THE-ROAD PRICES

	5-seat MPV		7-seat MPV		Insurance Group
	OTR RRP	CO ₂ (g/km)	OTR RRP	CO ₂ (g/km)	
Petrol					
1.2 (110PS) Turbo S/S	£22,435	125	-	-	8E
Diesel					
1.5 (100PS) Turbo D S/S BlueInjection	£22,965	113	£23,765	115	8E – 9E

Please note: On-the-road recommended retail prices (RRP) include VAT at 20%, number plates and delivery to Retailer of £700.00 (inc. £116.67 VAT), 12 months' Vehicle Excise Duty and new vehicle first registration fee of £55.00. Excludes fuel and insurance.

S/S = Start/Stop.

FEATURES

Infotainment:

- Touchscreen infotainment system digital radio, Bluetooth® audio streaming, Bluetooth® mobile phone portal, USB audio connection
- 8-inch colour touchscreen
- Apple CarPlay™/Android Auto™ • Six speakers

Interior convenience/styling:

- Height-adjustable driver's seat • Air conditioning
- Steering wheel mounted audio controls
- Chrome-effect instrument rings
- Chrome-effect interior door handles
- 60/40 split-folding rear seat back (5-seat models)
- 35/30/35 split-folding second-row seats with fold-flat facility (7-seat models)
- Two individual split-folding and removable third-row seats (7-seat models)
- Sliding facility for third row seats (7-seat XL models only)
- Front-seat back pockets (7-seat models)
- Two foldable tables with cupholders (7-seat models)
- Luggage compartment cover

Exterior convenience/styling:

- Keyless entry and start – Standard on automatic models only.
- Automatic windscreen wipers • High beam assist
- Front and rear parking sensors • Front fog lights

- Electrically adjustable/heated body-colour door mirrors
- Electrically operated front windows with safety autoreverse and one-touch up/down facility
- Nearside and offside sliding side-access door with opening windows
- Daytime running lights
- Tailgate with heated rear window and wiper
- Body-colour bumpers, door handles and side-access door railcovers
- Body-colour side protection mouldings
- 16-inch alloy wheels with 205/60 R16 tyres
- Emergency tyre inflation kit

Safety/security:

- Automatic emergency braking with pedestrian detection
- Electronic stability programme with traction control
- Anti-lock braking system
- Forward collision alert
- Emergency brake assist
- Lane keep assist with lane departure warning
- Automatic lighting control
- Cruise control with speed limiter
- Speed sign recognition
- Six airbags • Driver drowsiness system

COMBO LIFE PRICES

	Price (£)	VAT (£)	Total (£)	On-the-road RRP (£)	BiK 20% (£)	CO ₂ (g/km)
DESIGN						
1.2 (110PS) Turbo Start/Stop Diesel	16,008.33	3,201.67	19,210.00	20,135.00	96.22	125
1.5 (100PS) Turbo D Start/Stop BlueInjection*	16,416.67	3,283.33	19,700.00	20,665.00	101.98	111
1.5 (130PS) Turbo D Start/Stop auto BlueInjection*	18,516.67	3,703.33	22,220.00	23,185.00	114.58	114
DESIGN XL						
1.2 (110PS) Turbo Start/Stop Diesel	16,758.33	3,351.67	20,110.00	21,035.00	100.57	125
1.5 (100PS) Turbo D Start/Stop BlueInjection*	17,166.67	3,433.33	20,600.00	21,565.00	106.48	113
ENERGY						
1.2 (110PS) Turbo Start/Stop Diesel	17,175.00	3,435.00	20,610.00	21,535.00	102.98	125
1.5 (100PS) Turbo D Start/Stop BlueInjection*	17,583.33	3,516.67	21,100.00	22,065.00	108.98	111
1.5 (130PS) Turbo D Start/Stop BlueInjection*	18,516.67	3,703.33	22,220.00	23,185.00	114.58	114
1.5 (130PS) Turbo D Start/Stop auto BlueInjection*	19,683.33	3,936.67	23,620.00	24,585.00	121.58	114

	Price (£)	VAT (£)	Total (£)	On-the-road RRP (£)	BiK 20% (£)	CO ₂ (g/km)
ENERGY (7-seat)						
1.2 (110PS) Turbo Start/Stop Diesel	17,758.33	3,551.67	21,310.00	22,235.00	106.37	125
1.5 (100PS) Turbo D Start/Stop BlueInjection*	18,166.67	3,633.33	21,800.00	22,765.00	116.23	115
ENERGY XL						
1.2 (110PS) Turbo Start/Stop Diesel	17,925.00	3,585.00	21,510.00	22,435.00	107.33	125
1.5 (100PS) Turbo D Start/Stop BlueInjection*	18,333.33	3,666.67	22,000.00	22,965.00	113.48	113
ENERGY XL (7-seat)						
1.5 (100PS) Turbo D Start/Stop BlueInjection*	19,000.00	3,800.00	22,800.00	23,765.00	121.40	115

S/S = Start/Stop.

*Vehicles with BlueInjection technology will need regular AdBlue® top-ups also between servicing requirements. An indicator integrated into the on-board computer will warn you when you need to top up. More information under www.vauxhall.co.uk/adblue. In accordance with regulations R (EC) No. 715/2007 and R (EC) No. 692/2008 (in the versions respectively applicable).

Please note: On-the-road recommended retail prices (RRP) include number plates and delivery to retailer of £700.00 (inc. £116.67 VAT), 12 months' Vehicle Excise Duty and new vehicle first registration fee of £55.00. Excludes fuel and insurance. Company Car Benefit in Kind (BiK) rates are monthly based on the standard paint price.

FEATURES/OPTIONS

SAFETY

	Option code	Design	Energy	Price (£) exc. VAT	Price (£) inc. VAT
Driver/passenger airbags • Driver's airbag • Front passenger's airbag • Two front seat side-impact airbags • Full-size curtain airbags for driver and front and outer rear seat passengers		●	●		
Seatbelts • Lap and diagonal inertia-reel seatbelts (height-adjustable front) • Front body-lock diagonal seatbelt pretensioner system – Tightens the seatbelt during the early stages of a frontal impact • Drivers and front passenger's lap belt pretensioner system • Front seatbelt force limiters – Reduces potential upper body injuries during a frontal impact • Anti-submarining ramps in front seats – Help prevent occupants sliding underneath the lap belt during a collision • 'Seatbelt unfastened' audible warning and warning light.		●	●		
Child safety • Deactivation switch for front passenger's front and side-impact airbags – Permits the safe use of a child seat in the front passenger seat. • ISOFIX child seat mountings incorporating top tether anchor points located on second-row rear seats (does not include child seat) – Allows ISOFIX child safety seats to be securely fixed into the car. The ISOFIX mounting system reduces forward movement in an accident and makes the child seat easier to install. • Child-proof locks on rear doors		●	●		
Driver/passenger safety • Energy-absorbing steering column • Side-impact protection beams • Reinforced passenger safety cell • Deformation zones front and rear		●	●		
Braking and stability • Electronic stability programme • Anti-lock braking system • Corner stability control • Traction control • Hill start assist • Engine drag torque control – Improves directional stability by preventing the driven wheels from locking on slippery surfaces under the influence of engine braking. • Emergency brake assist • Electronic brakeforce distribution		●	●		
Tyre pressure • Deflation detection system		●	●		

● = Standard equipment.

FEATURES/OPTIONS

DRIVER ASSISTANCE

	Option code	Design	Energy	Price (£) exc. VAT	Price (£) inc. VAT
<p>Mechanical parking brake</p> <ul style="list-style-type: none"> Floor-mounted handbrake lever 		●	●		
<p>Cruise control with speed limiter and intelligent speed adaptation</p> <p>The cruise control feature enables you to maintain a constant speed – making it ideal for economical motorway driving. The speed limiter function can be set to ensure that you do not exceed the speed limit and can be easily overridden if required. Working in conjunction with speed sign recognition, when a new speed limit is detected a message appears in the driver information display. You can then set the cruise control to the new speed limit with a simple press on a steering wheel button.</p>		●	●		
<p>Front camera system</p> <p>A range of class-leading driver assistance and safety features are controlled by the front camera system.</p>					
<p>Lane keep assist with lane departure warning</p> <p>If the driver has not actively steered or signalled, the lane departure warning system provides gentle steering correction and warns when the car moves outside of lane markings at speeds above 40mph.</p> <ul style="list-style-type: none"> Warning light in instrument cluster Audible warning Facia on/off switch 		●	●		
<p>Speed sign recognition</p> <p>Detects and then displays speed limits, reducing uncertainty and the risk of speeding.</p> <ul style="list-style-type: none"> Recognises different speed signs, including temporary speed restrictions Displays reminder in the instrument cluster 					
<p>Driver drowsiness system</p> <p>The system monitors driving time and driving behaviour to help prevent accidents caused by tiredness.</p>		●	●		
<p>Forward collision alert</p> <p>The system operates automatically from 3mph and gives an audible warning as well as a visual warning when approaching another vehicle too quickly.</p>		●	●		

● = Standard equipment.

FEATURES/OPTIONS

DRIVER ASSISTANCE CONTINUED

	Option code	Design	Energy	Price (£) exc. VAT	Price (£) inc. VAT
<p>Automatic emergency braking with pedestrian detection</p> <p>The system works automatically in conjunction with forward collision alert, at speeds between 3mph and 70mph, and detects both vehicles and pedestrians. If no avoiding action is taken by the driver, at speeds below 19mph the system automatically slows the vehicle to a full stop with emergency braking of 0.9g. At speeds from 19mph to 70mph it brakes automatically to reduce speed by a maximum of 30mph – To reduce speed even further the driver must brake him/herself. The operational speed range of the system depends on the detected obstacle (mobile target: from 3 to 53mph; fixed target: from 3 to 70mph; pedestrian: from 3 to 37mph). Vauxhall driver assistance systems are intended to support the driver within the system-imminent limitations. The driver remains responsible for the driving task.</p>		●	●		
<p>Parking sensors</p> <ul style="list-style-type: none"> • Front and rear parking distance sensors with audible warning 			●		
<ul style="list-style-type: none"> • Rear parking distance sensors with audible warning 	UD7	○	●	166.67	200.00
<p>Parking Pack – Design</p> <p>Intelligent ultrasonic sensors form part of the solution for today’s crowded roads and car parks – Delivering exceptional assistance both when parking and protecting you on the open road.</p> <p>– Only available in conjunction with optional navigation unit.</p> <ul style="list-style-type: none"> • Front and rear parking distance sensors • 180° panoramic rear-view camera • Side blind spot alert • Electrically foldable door mirrors • Electrically operated rear windows • Front fog lights with cornering light function 	XIEE	○		750.00	900.00
<p>Parking Pack – Energy</p> <p>Intelligent ultrasonic sensors form part of the solution for today’s crowded roads and car parks – Delivering exceptional assistance both when parking and protecting you on the open road.</p> <p>– Only available in conjunction with optional navigation unit.</p> <ul style="list-style-type: none"> • 180° panoramic rear-view camera • Side blind spot alert • Electrically foldable door mirrors • Electrically operated rear windows 	XIEE		○	333.33	400.00

● = Standard equipment. ○ = Optional at extra cost.

FEATURES/OPTIONS

DRIVER ASSISTANCE CONTINUED

	Option code	Design	Energy	Price (£) exc. VAT	Price (£) inc. VAT
<p>Advanced park assist</p> <p>Advanced park assist not only detects suitable parking spaces but also expertly steers into them for you. All you have to do is to drive forward or reverse and brake. The system works with both parallel and bay parking.</p> <ul style="list-style-type: none"> • Automatic pull-out function • Ultrasonic side sensors identify suitable parking spaces at speeds up to 12mph • Fully automated steering • Detailed forward/reverse instructions are shown in the instrument cluster <p>– Only available when the optional Parking Pack is specified.</p>	UFQ		○	166.67	200.00
<p>Head-up display</p> <p>The head-up display projects key information onto the windscreen so that the driver's eyes remain on the road at all times. The display is adjustable for height and brightness.</p> <p>Displays:</p> <ul style="list-style-type: none"> • Navigation directions (where fitted) • Speedometer • Rev counter • Set speed of cruise control and speed limiter • Forward collision alert 	UV6		○	295.83	355.00
<p>All Weather Pack</p> <p>For those drivers who regularly take their vehicle off road, this pack helps the driver cope with whatever conditions they encounter.</p> <p>Please note: The All Weather Pack option affects CO₂ emissions which may result in a change in Vehicle Excise Duty.</p> <ul style="list-style-type: none"> • IntelliGrip: A choice of five selectable modes to suit the driving conditions: ESP on, ESP off, snow, mud or sand • Includes all-weather tyres 	PS4	○	○	341.67	410.00
<p>Sight and Light Pack</p> <ul style="list-style-type: none"> • High beam assist • Rain-sensitive windscreen wipers <p>– Standard on automatic models</p>	CWX	○	●	166.67	200.00
<p>Automatic lighting control</p>		●	●		

● = Standard equipment. ○ = Optional at extra cost.

FEATURES/OPTIONS

SECURITY

	Option code	Design	Energy	Price (£) exc. VAT	Price (£) inc. VAT
Standard security features • Electronically protected audio equipment • Engine deadlock immobiliser • Visible Vehicle Identification Number (VIN) • Locking wheel nuts (Energy models only)		●	●		
Remote control central locking • Operates on doors, tailgate and fuel filler flap • Deadlocking • Driver's internal central locking activation switch • Two folding keys, each with integral remote control function		●	●		
Remote control security alarm system • Remote control (operates in conjunction with central locking) • Bonnet protection – Prevents access to the engine bay. • Visible security LED on facia • Luggage protection – Monitors the luggage compartment preventing access. • Door protection – Monitors the position of all doors • Ultrasonic intrusion sensor • Power alarm sounder • Vehicle theft attempt and diagnostic indication – Shows in the display any attempt to enter or steal the vehicle during driver absence.	PS6	○	○	166.67	200.00

DRIVER INFORMATION

Instrumentation • Speedometer • Rev counter • Fuel gauge with low fuel level warning light • Water temperature gauge with warning light • Shift-up indication light (manual models only) – Indicates when to change gear for optimum fuel economy.		●	●		
Driver information display (centrally located in instrument cluster) • Displays trip computer data • Total mileage • Service-due indicator • Deflation detection system • 3.5-inch colour information display		●	●		
Multi-function trip computer (displayed on driver information display) • Trip mileage • Vehicle range based on remaining fuel • Average speed • Average fuel economy • Instantaneous fuel economy		●	●		
Central facia display (format dependent on infotainment unit) • Audio information • Digital clock with automatic RDS time adjustment • Outside air temperature with ice warning function • Additional features dependent on infotainment unit (see infotainment for details)		●	●		

● = Standard equipment. ○ = Optional at extra cost.

FEATURES/OPTIONS

SEATING AND COMFORT

	Option code	Design	Energy	Price (£) exc. VAT	Price (£) inc. VAT
Adjustable steering column Reach and rake-adjustable steering column		●	●		
Comfort front seats Driver's seat: • Height • Reach • Backrest • Manual lumbar adjustment • Armrest • Under seat storage • Four-way adjustable head restraint Front passenger's seat: • Reach • Backrest • Four-way adjustable head restraint		●	●		
Rear seating Second-row (5-seat models): • Three-person layout 60/40 split-folding rear seat • Height-adjustable and removable head restraints • ISOFIX child seat mountings incorporating top tether anchor points located on rear seats (does not include child seat) – Allows ISOFIX child safety seats to be securely fixed into the car. The ISOFIX mounting system reduces forward movement in an accident and makes the child seat easier to install		●	●		
Rear seating Second-row (7-seat models): • Three-person layout 35/30/35 individual split-folding second-row seats with sliding function (XL models only) plus fold-flat facility • Height-adjustable and removable head restraints • ISOFIX child seat mountings incorporating top tether anchor points located on rear seats (does not include child seat)			●		
Rear seating Third-row (7-seat models): • Two individual removable/folding seats • Height-adjustable and removable head restraints			●		
Seat trim: • Mistral Grey with Curitiba fabric seat trim inserts		●			
• Mistral Grey with Angora Stripe fabric seat trim inserts			●		

● = Standard equipment.

FEATURES/OPTIONS

HEATING AND VENTILATION

	Option code	Design	Energy	Price (£) exc. VAT	Price (£) inc. VAT
Air conditioning • Air recirculation facility • Cabin particulate filter – Removes dust, airborne particles and pollen. • Multi-speed fan • Illuminated controls		●	●		
Electronic climate control including air conditioning • Dual-zone control – Allowing different, temperature settings for driver and front passenger. • Advanced predictive logic control system using sun sensors • Partial air recirculation – Faster warm up/cool down. • Cabin particulate filter – Removes dust, airborne particles and pollen. • Automatic air direction and fan speed with manual override • LCD temperature display • Illuminated controls	CJ2	○	○	166.67	200.00
Winter Pack  • Heated leather-covered steering wheel • Heated front seats – Only available when cruise control and Safety Pack are specified. Not available on automatic models.	XIBV	○	○	166.67	200.00

INTERIOR CONVENIENCE AND STORAGE

Mirrors • Dipping rear-view mirror • Driver's sunvisor incorporating vanity mirror with cover		●	●		
Front compartments • Two fascia-mounted drinks holders • Two drinks holders in centre console • Large open storage pocket behind infotainment screen • Small open storage compartment behind gear knob • Two large and two small open door pockets • Open storage compartment below glovebox • Underseat drawer (driver's side) • Full-width overhead storage shelf with ambient lighting		●	●		
Sunroof/storage • Full-length panoramic glass sunroof with overhead storage and ambient lighting • Storage compartments above rear seats with additional access from rear load area – Not available on XL models or 7-seat models.	C2K		○	700.00	840.00
Rear compartments • Two door pockets		●	●		
Luggage area • Luggage compartment cover			●		

● = Standard equipment. ○ = Optional at extra cost.

FEATURES/OPTIONS

INTERIOR CONVENIENCE AND STORAGE CONTINUED

	Option code	Design	Energy	Price (£) exc. VAT	Price (£) inc. VAT
Child Pack <ul style="list-style-type: none"> • Rear-view child-minder mirror – Located above the regular rear-view mirror and lets the driver as well as the front seat passenger keep an eye on the kids and the tailgate whilst maintaining full concentration on the road ahead. • Rear side window sunblind • Fold-flat passenger seat • Luggage restraint net – Only available on 7-seat models. 	WV6		○	208.33	250.00

MECHANICAL

Front-wheel drive		●	●	
Five-speed manual gearbox – 1.5 (100PS) diesel models.		▲	▲	
Six-speed manual gearbox – 1.2i Petrol/1.5 (130PS) diesel models.		▲	▲	
Eight-speed automatic transmission – available on 1.5 (130PS) models.		▲	▲	

INFOTAINMENT

Radio Onboard features: • AM/FM stereo radio • DAB Digital radio • RDS with Traffic Programme • 20 watts per channel output Media connections: • USB connection with iPod control • Bluetooth® A2DP audio streaming (Advanced Audio Distribution Profile) Mobile phone portal: • Bluetooth® connectivity • Handsfree calls via steering wheel controls • Vehicle microphone		●		
--	--	---	--	--

● = Standard equipment. ○ = Optional at extra cost. ▲ = See price page for details.

FEATURES/OPTIONS

INFOTAINMENT CONTINUED

	Option code	Design	Energy	Price (£) exc. VAT	Price (£) inc. VAT
<p>Multimedia</p> <p>Onboard features:</p> <ul style="list-style-type: none"> • 8-inch colour touchscreen • AM/FM stereo radio with 25 Station presets • DAB Digital radio • RDS with Traffic Programme • 20 watts per channel output • Four speakers <p>Media connections:</p> <ul style="list-style-type: none"> • USB connection with iPod control • Bluetooth® A2DP audio streaming (Advanced Audio Distribution Profile) <p>Mobile phone portal:</p> <ul style="list-style-type: none"> • Bluetooth® connectivity • Handsfree calls via steering wheel controls • Vehicle microphone • Phone book access – Contacts/last calls/missed calls etc. are mirrored on the display and are easily navigated using the touchscreen (features dependent on mobile phone). <p>Smartphone interface:</p> <ul style="list-style-type: none"> • Apple CarPlay™ • Android Auto™ – Smartphone projection that allows operations via voice command, touchscreen and buttons to control apps and music playback. 	IO5	○	●	166.67	200.00
<p>Multimedia Navi Pro</p> <p>Onboard features:</p> <ul style="list-style-type: none"> • 8-inch colour touchscreen • AM/FM stereo radio with 25 Station presets • DAB Digital radio • RDS with Traffic Programme • 20 watts per channel output • Four speakers <p>Navigation features:</p> <ul style="list-style-type: none"> • Satellite navigation system • 3D street level mapping • European coverage • Structured or one-box destination entry • Points-of-interest search • Eco routing • Map updates via USB <p>Media connections:</p> <ul style="list-style-type: none"> • USB connection with iPod control • Bluetooth® A2DP audio streaming (Advanced Audio Distribution Profile) <p>Mobile phone portal:</p> <ul style="list-style-type: none"> • Bluetooth® connectivity • Handsfree calls via steering wheel controls • Vehicle microphone • Phone book access – Contacts/last calls/missed calls etc. are mirrored on the display and are easily navigated using the touchscreen (features dependent on mobile phone). <p>Smartphone interface:</p> <ul style="list-style-type: none"> • Apple CarPlay™ • Android Auto™ – Smartphone projection that allows operations via voice command, touchscreen and buttons to control apps and music playback. 	IO6	○		541.67	650.00
			○		375.00

● = Standard equipment. ○ = Optional at extra cost.

FEATURES/OPTIONS

INFOTAINMENT CONTINUED

	Option code	Design	Energy	Price (£) exc. VAT	Price (£) inc. VAT
Steering wheel mounted audio controls		●	●		
Power supply • 12-volt electrical accessory socket in centre console • 12-volt electrical accessory socket (passenger side) • USB charging point in glovebox • USB charging/infotainment points – Infotainment unit and rear of centre console.		●	●		
230-volt electrical accessory socket • 230-volt electrical accessory socket – In lieu of passenger side 12-volt electrical accessory socket.	KI5	○	○	41.67	50.00
Wireless charging • Wireless charger for mobile devices – Inductive wireless charging facility in lower facia.	K4C	○	○	87.50	105.00

EXTERIOR STYLING AND CONVENIENCE

Body styling • Chrome-effect front grille bar • Body-colour door handles/mirrors • Body-colour bumpers and side-protection mouldings			●		
• Chrome-effect front grille bar • Body-colour bumpers		●			
Windscreen/windows • Solar heat-absorbing windscreen • Two-speed windscreen wipers with variable intermittent wipe • Electrically operated front windows with safety autoreverse and one-touch facility • Tinted windows • Heated rear window • Intermittent rear window wash/wipe		●	●		
• Dark-tinted rear windows – Only available when Parking Pack and Tailgate with opening window options are specified.	AKO		○	91.67	110.00

● = Standard equipment. ○ = Optional at extra cost.







FEATURES/OPTIONS

EXTERIOR STYLING AND CONVENIENCE CONTINUED

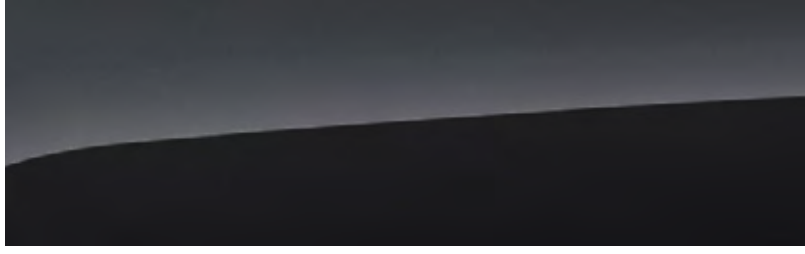
	Option code	Design	Energy	Price (£) exc. VAT	Price (£) inc. VAT
Door mirrors • Twin electrically adjustable/heated door mirrors • Manually folding door mirrors		●	●		
• Electrically foldable door mirrors		□	□		
Tailgate • Glazed tailgate with heated window and wash/wipe facility		●	●		
• Glazed tailgate with opening heated window and wash/wipe facility – Only available with Parking Pack and dark-tinted rear windows	J20		○	254.17	305.00
Tow bar • Detachable tow bar • Trailer stability programme integrated into ESP system	VQ9	○	○	416.67	500.00
Roof rails	E2R	○	○	125.00	150.00

● = Standard equipment. ○ = Optional at extra cost. □ = Available as part of an extra-cost option pack.

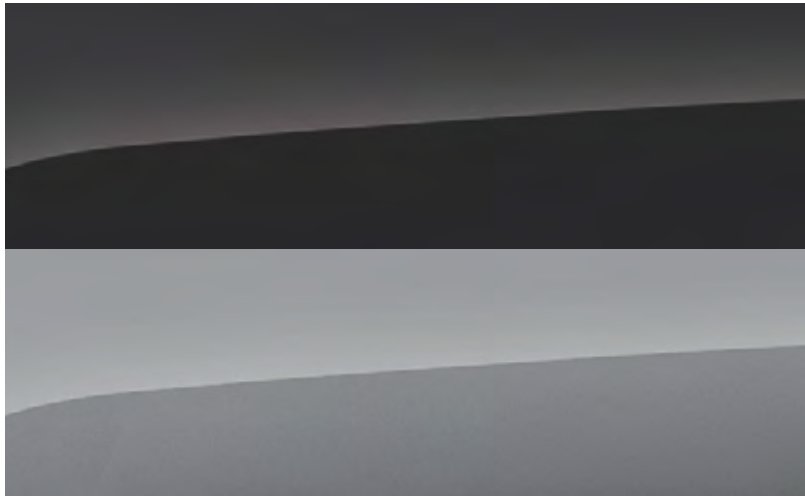
EXTERIOR COLOURS

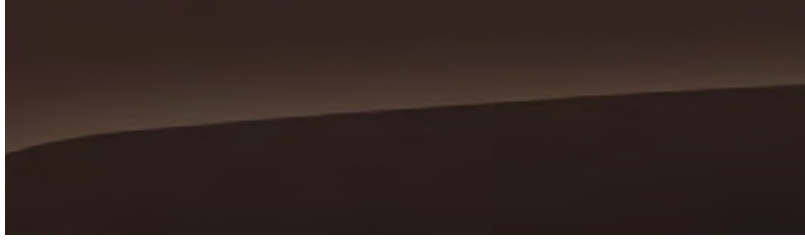
					Design	Energy	Price (£) exc. VAT	Price (£) inc. VAT
Solid		Onyx Black (G7R)		White Jade (G20)	●	●		
		Ruby Red (GEO)			○	○	237.50	285.00
Two-coat		Cool Grey metallic (GAC)		Moonstone Grey metallic (G40)	○	○	470.83	565.00
		Night Blue metallic (GBT)		Quartz Grey metallic (G4I)				
		Cosmic Brown pearlescent (GLV)						

The colours reproduced may vary slightly from the actual paint colour. As a result they should be used as a guide only. Your Vauxhall Retailer has a comprehensive display of our paint samples.

● = Standard equipment. ○ = Optional at extra cost.

WHEELS AND TYRES

	Option code	Design	Energy	Price (£) exc. VAT	Price (£) inc. VAT
Full-size steel spare wheel (in lieu of emergency tyre inflation kit)	RU9	○	○	91.67	110.00
 <p>16-inch steel wheels with full diameter wheel covers</p> <ul style="list-style-type: none"> • 205/60 R 16 tyres • Emergency tyre inflation kit (in lieu of spare wheel) 		●			
 <p>16-inch seven-spoke alloy wheels</p> <ul style="list-style-type: none"> • 205/60 R 16 tyres • Emergency tyre inflation kit (in lieu of spare wheel) 			●		

● = Standard equipment. ○ = Optional at extra cost.

PERFORMANCE, FUEL ECONOMY AND EMISSIONS

	Performance (manufacturer's figures)				Fuel economy mpg (litres/100km)#		CO ₂ emissions g/km*	Vehicle Excise Duty**		Benefit in kind company car taxation rates - 2019/20 tax year
	Fuel Type	Wheel size (inches)	Maximum speed (mph)	Acceleration 0-60mph (sec)	Combined Low	Combined High		First year rate	Standard rate	
COMBO LIFE										
1.2 (110PS) Turbo S/S	Petrol	16	109	11.9	37.5 (7.5)	42.4 (6.7)	125	£170	£145	29%
1.5 (100PS) Turbo D S/S BlueInjection	Diesel	16	107	12.7	42.2 (6.7)	50.8 (5.6)	111	£210	£145	30%
1.5 (130PS) Turbo D S/S BlueInjection	Diesel	16	115	10.6	44.8 (6.3)	50.9 (5.6)	114	£210	£145	30%
1.5 (130PS) Turbo D S/S BlueInjection automatic	Diesel	16	114	11.4	45.2 (6.2)	50.7 (5.6)	114	£210	£145	30%
COMBO LIFE XL										
1.2 (110PS) Turbo S/S	Petrol	16	109	12.0	37.5 (7.5)	42.4 (6.7)	125	£170	£145	29%
1.5 (100PS) Turbo D S/S BlueInjection	Diesel	16	107	12.9	42.2 (6.7)	50.8 (5.6)	113	£210	£145	30%
COMBO LIFE (7-SEAT)†										
1.2 (110PS) Turbo S/S	Petrol	16	109	11.8	37.5 (7.5)	42.4 (6.7)	125	£170	£145	29%
1.5 (100PS) Turbo D S/S BlueInjection	Diesel	16	106	12.7	42.2 (6.7)	50.8 (5.6)	115	£210	£145	31%
COMBO LIFE XL (7-SEAT)†										
1.5 (100PS) Turbo D S/S BlueInjection	Diesel	16	106	13.0	42.2 (6.7)	50.8 (5.6)	115	£210	£145	31%

S/S = Start/Stop

#Fuel consumption figures are determined according to the WLTP test cycle. Full data relating to WLTP test cycles can be found at: www.vauxhall.co.uk/wltp

*CO₂ emissions figures are determined according to the WLTP test cycle however, a Government formula is then applied to translate these figures back to what they would have been under the outgoing NEDC test cycle, which WLTP replaces. The correct tax treatment is then applied.

Figures are intended for comparability purposes only. The fuel consumption you achieve under real life driving conditions and CO₂ produced will depend upon a number of factors, including the accessories fitted after registration, variations in driving styles, weather conditions and vehicle load. Only compare fuel consumption and CO₂ with other vehicles tested using the same technical procedures. For more information contact your local Vauxhall Retailer.

**Correct at time of publication.

†Available on Energy models only.

DIMENSIONS

Loadspace Dimensions	LIFE	LIFE XL
Maximum load floor length – passenger seat folded	2700 (106.3)	3050 (120.1)
Maximum load length – behind front seats	1880 (74.0)	2230 (87.8)
Maximum load length – behind second-row seats	914 (36.0)	1350 (53.1)
Maximum load length – behind third-row seats*	236 (9.3)	418 (16.5) – 566 (22.3)
Maximum load height	1126 (44.3)	1119 (44.0)
Maximum load width	1195 (47.0)	1195 (47.0)
Maximum width between wheel arches	1149 (45.2)	1129 (44.4)
Loading height	584 (23.0)	620 (24.4)
Maximum tailgate aperture width	1087 (42.8) – 1241 (48.9)	1087 (42.8) – 1241 (48.9)
Maximum tailgate aperture height	1126 (44.3)	1126 (44.3)
Maximum height under raised tailgate	1892 (74.5)	1892 (74.5)
Maximum side-access aperture width	640 (25.2) – 745 (29.3)	640 (25.2) – 745 (29.3)
Maximum side-access aperture height	1145 (45.1)	1145 (45.1)
Luggage Capacities** litres (cu.ft.)		
Behind front-row seats to glassline	1414 (49.9)	1672 (59.0)
Behind front-row seats to roof	2126 (75.1)	2693 (95.1)
Behind second-row seats to glassline	597 (21.1)	850 (30.0)
Behind second-row seats to roof	983 (34.7)	1538 (54.3)
Behind third-row seats*	571 (20.2)	806 (28.5)

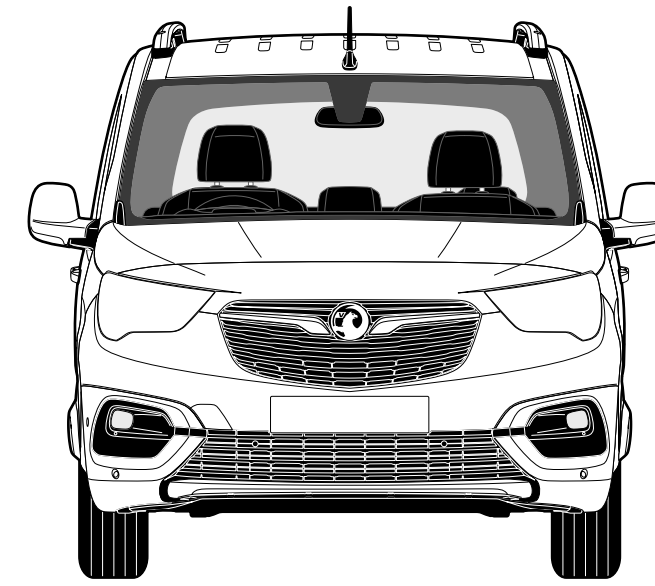

1921 (75.6)
excluding door mirrors
2107 (83.0)
including door mirrors

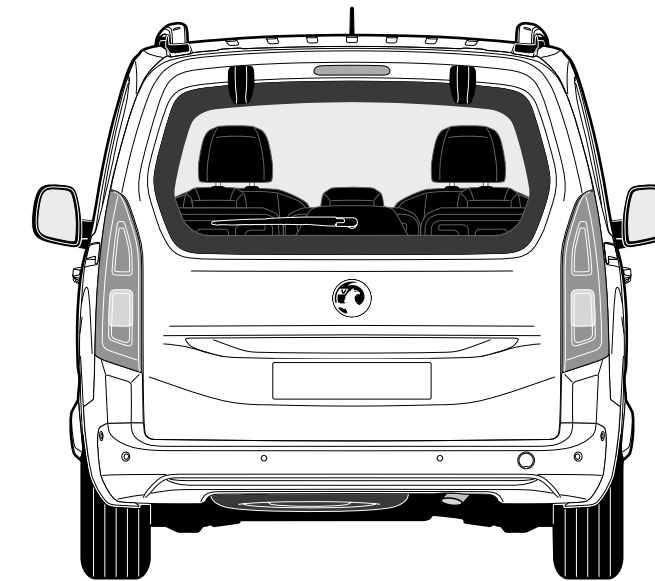

1921 (75.6)
excluding door mirrors
2107 (83.0)
including door mirrors

1841
(72.5)
including
roof rails

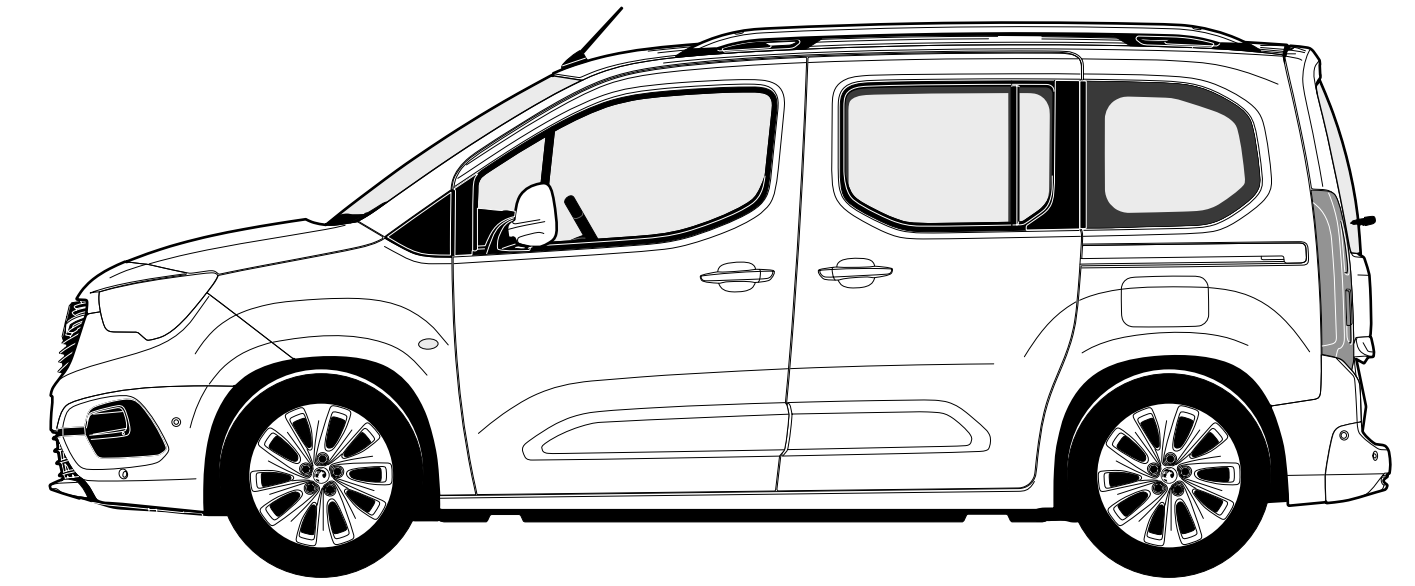

892 (35.1) 2785 (109.6) 726 (28.6)
4403 (173.3)

LIFE

1880
(74.0)
including
roof rails

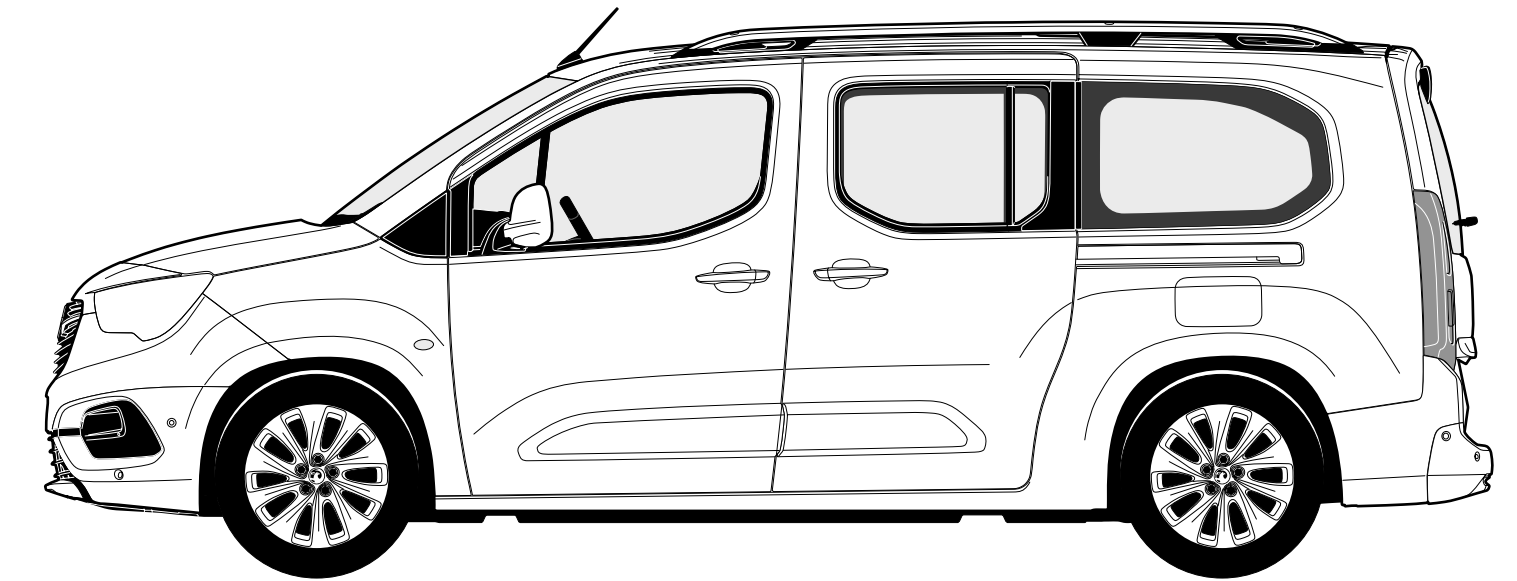

892 (35.1) 2977 (117.2) 884 (34.8)
4753 (187.1)

LIFE XL

All measurements are in mm (inches) unless stated otherwise.

*Energy models only.

**Measured using the ECIE method.

SPECIFICATIONS

Transmission

Five-speed manual gearbox:
1.5 (100PS) Turbo D models.

Six-speed manual gearbox:
1.2 (110PS) Turbo/1.5 (130PS) Turbo D models.

Eight-speed automatic transmission:
1.5 (130PS) Turbo D models.

Replacing the traditional lever, the automatic transmission selection-mode dial/drive wheel is an innovation solution that is both elegant and intuitive. By simply twisting the dial, the following modes can be selected:

- Park, for when the vehicle is stationary and the wheels are locked
- Drive, for automatic forward motion
- Neutral, for when the vehicle is stationary, wheels are free
- Reverse, for automatic backward motion

Fuel tank capacity

61 Litres (13.4 gallons) – Petrol models.
50 Litres (10.9 gallons) – Diesel models.

AdBlue tank capacity
17 Litres (3.7 gallons).

Steering

Turning circle (kerb-to-kerb) –
11.0m (36 ft) Life models,
11.8m (38.7 ft) Life XL models.

Weights and Towing Data kg

	Gross vehicle weight	Maximum towing weights Trailer with brakes (without brakes)
COMBO LIFE		
1.2 (110PS) Turbo	2040	1150 (600)
1.5 (100PS) Turbo D	2095	1300 (730)
1.5 (130PS) Turbo D	2120	1500 (730)
1.5 (130PS) Turbo D automatic	2130	1500 (730)
1.2 (110PS) Turbo (7-seat)	2205	1100 (600)
1.5 (100PS) Turbo D (7-seat)	2250	1150 (600)
COMBO LIFE XL		
1.2 (110PS) Turbo	2070	1100 (600)
1.5 (100PS) Turbo D	2115	1250 (600)
1.5 (100PS) Turbo D (7-seat)	2310	1250 (600)

Gross vehicle weight is the total permissible weight of the vehicle including passengers and their luggage. The **maximum roof rack loading** should not exceed 100kg on all models. The **maximum towing weights** are based on the ability of the car, with two occupants of 75kg each, to restart on a 12% gradient, which is approximately 1 in 8.3, at sea level. The permitted trailer load applies up to the specified incline and up to an altitude of 1000 metres above sea level. The permissible gross train weight decreases by 10% for every 1000 metres of additional altitude. Any extra weight, such as luggage or additional passengers, should be deducted from the maximum towing weight. Always fit Vauxhall towing attachments and accessories available from your Vauxhall Retailer. They are designed specifically for Vauxhall models and carry a 12-month guarantee. During trailer towing do not exceed a maximum speed of 60mph. This speed limit is also applicable in countries with higher permitted speeds for trailer-vehicle combinations. Pay attention to the local speed limits. For trailers with low driving stability and caravans the use of an oscillation damper is strongly recommended.

PETROL ENGINE

Engine	1.2 (110PS) Turbo Start/Stop
Capacity	1199cc
Maximum power	110PS (81kW) @ 5500rpm
Maximum torque	205Nm (151 lb.ft.) @ 1750rpm
Configuration	3 cylinders, 4 valves per cylinder, double overhead camshafts
Fuel/induction system	Turbocharger. Variable Valve Timing. Direct fuel injection
Emission compliance	Euro 6d-TEMP (6.2)
Service interval	16,000 miles or 1 year (whichever occurs sooner)

DIESEL ENGINES

Engine	1.5 (100PS) Turbo D Start/Stop BlueInjection	1.5 (130PS) Turbo D Start/Stop BlueInjection
Capacity	1499cc	1499cc
Maximum power	100PS (75kW) @ 3500rpm	130PS (96kW) @ 3750rpm
Maximum torque	250Nm (184 lb.ft.) @ 1750rpm	300Nm (221 lb.ft.) @ 1750rpm
Configuration	4 cylinders, 4 valves per cylinder, double overhead camshafts	4 cylinders, 4 valves per cylinder, double overhead camshafts
Fuel/induction system	Variable-nozzle turbocharger with electric switching. Common rail direct injection	Variable-nozzle turbocharger with electric switching. Common rail direct injection
Emission compliance	Euro 6d-TEMP (6.2). Diesel Particulate Filter	Euro 6d-TEMP (6.2). Diesel Particulate Filter
Service interval	20,000 miles or 1 year (whichever occurs sooner)	20,000 miles or 1 year (whichever occurs sooner)

ACCESSORIES

SAFETY Total (inc. VAT)

Safety Pack – first aid kit, hi-visibility vest and small warning triangle	£30
Warning triangle – Small	£12
Warning triangle – Large	£20
First aid kit	£15
Hi-visibility vest	£9

PRACTICAL

Spare bulb kit	£28
Stretch tow rope – 3 tonne	£36
Smokers pack	£34

PROTECTION

Carpet mats (set of 4)	£32
Rubber mats (set of 4)	£52
Splash Guards – Rear (fitted)	£61
Front parking sensors	£418
Rear parking sensors	£365
Hard Cargo Liner	£57

TRANSPORT SYSTEMS Total (inc. VAT)

Roof base carrier ¹ (set of 2 bars)	£191
Additional roof base carrier (1 bar)	£96
Roof carriers (requires base carrier)	
Bike roof carrier – Thule Freeride 532	£78
Surf board roof carrier – Thule 833	£82
Kayak roof carrier – Thule 837	£172
Ski roof carrier (up to 4 pairs) Thule 7324	£161
Ski roof carrier (up to 6 pairs) Thule 7326	£190
Hard shell roof boxes (requires base carrier)	
Thule Ocean 80 (320 litre/1330 x 860 x 370mm)	£154
Thule Ocean 200 (450 litre/1750 x 820 x 450mm)	£323
Thule Motion 800 (460 litre/2050 x 840 x 450mm)	from £463
Thule Touring 200 (400 litre/1720 x 820 x 450mm)	£338
Thule Touring 700 (430 litre/1960 x 780 x 430mm)	£384

SECURITY Total (inc. VAT)

Privacy Shades – Side Rear Windows (tilt/turn window) – set of 2	£46
Privacy Shades – Side Rear Windows (electric window) – set of 2	£46
Privacy Shades – Quarter Side Rear Window Set of 2	£46
Privacy Shade – Tailgate	£46

FLEXCONNECT RANGE

FlexConnect bracket	£28
FlexConnect hook	£32
FlexConnect coat hanger	£34
FlexConnect folding table	£77
FlexConnect iPad Mini cradle	£109
FlexConnect iPad (1-4) cradle	£118
FlexConnect iPad Air cradle	£117
FlexConnect Samsung Galaxy cradle	£107

CHILD SEATS²

BABY-SAFE ³ – 0-13kg/birth to 15 months	£141
– ISOFIX base	£244
DUO ISOFIX ³ – 9-18kg/9 months to 4 years with top tether kit	£372
KID ³ – 15-36kg or 4 to 12 years	£168

Please note: Prices shown are fully fitted and painted, where applicable and include VAT. Please check with your local Vauxhall Retailer for details. It is advisable to ensure your insurance policy is adequate to cover additional fitted accessories. Prices correct at time of publication.

¹A dedicated T-Track adapter (Thule 697-4 or Thule 697-6) is required for the installation of specific roof boxes, contact your local Vauxhall Retailer for details. ²Restrictions apply to the use of child seats, please consult your Vauxhall Retailer or request a copy of the Child seats brochure.

³Without transponder.

COMPANY CAR DRIVER AND FLEET INFORMATION

Design and Tech Line High Spec Low P11D

Specifically developed for businesses and company car drivers alike, our Design and Tech Line Nav models are seriously fit for Fleet.

Design models all feature very low P11D values, generous standard specification, including Sat Nav on Design Nav models, and a choice of high tech ecoTEC engines for great fuel economy and low emissions.

For even more standard specification, step up to our Tech Line Nav range. Again you are guaranteed low P11D values, plus great standard kit including Sat Nav, Bluetooth®, USB connection, aux-in socket and digital radio.

With Design and Tech Line Nav you can take for granted low Whole Life Costs and low company car driver taxation.

Company Car Driver Free 3 Day Test Drive

Our free* 3 Day Test Drive programme is open to all Company Car Drivers which allows you to choose any model in the current Vauxhall line-up (exclusions apply). With full insurance cover provided, it gives you a meaningful length of time to make an informed decision about your next company car.

Search Vauxhall 3DTD to book your FREE* test drive or click the link the below:

[Vauxhall 3 Day Test Drive](#)

*The free 3 Day Test Drive programme is open to Company Car Drivers and Fleet Decision Makers. Available for UK Mainland only. Terms and conditions apply. Full terms and conditions can be found at vauxhallfleet.co.uk/testdrive/index/terms.

Benefit in kind company car taxation†

The car benefit charge will be the car's list price (including VAT, options and accessories fitted, delivery to Retailer and number plates, but excluding Vehicle Excise Duty and new vehicle first registration fee) multiplied by the percentage charge for the CO₂ emissions band in which the car falls (see table opposite). Multiply this figure by your personal income tax rate (20%^{††} for Basic Rate, 40%^{††} for Higher Rate) to calculate your annual benefit in kind tax liability.

Example:

Combo Life Design 1.5 (100PS) Turbo D S/S BlueInjection (CO₂ emissions 111g/km)

On-the-road RRP	£20,665.00
Deduct: Vehicle Excise Duty	(£210.00)
New vehicle first registration fee	(£55.00)
Effective list price	£20,400.00
Add: Optional two-coat metallic paint	£565.00
List price for tax purposes (P11D value)	£20,965.00
Car benefit charge 2019-20 tax year (30%)	£6,290.00
Benefit in kind tax liability (2019-20 tax year)	
Basic Rate (20%) tax payer	£1,258.00
Higher Rate (40%) tax payer	£2,516.00

†Please note this Price Guide provides taxation information as a guide only. Vauxhall does not provide taxation guidance. Drivers should always take professional advice on their own tax position.

††Excludes residents of Scotland.

BIK FOR SCOTTISH RESIDENTS

Effective 6 April 2018 the Scottish Government have introduced their own BIK taxation structure. This only applies to Company Car Drivers that are Scottish taxpayers. HMRC will determine whether or not an individual is a Scottish taxpayer based on where their main place of residence is.

The BIK rates for Scotland are:

- Over £12,500-£14,549 Starter Rate 19%
- Over £14,549-£24,994 Basic Rate 20%
- Over £24,994-£43,430 Intermediate Rate 21%
- Over £43,430-£150,000 Higher Rate 41%
- Above £150,000 Top Rate 46%

Benefit in kind company car taxation table

CO ₂ emissions in grams per kilometre	Percentage of cars price to be taxed	
	Non-Diesel [#] 2019-20 tax year	Diesel ^{##} 2019-20 tax year
Up to 50	16	20
51-75	19	23
76-94	22	26
95-99	23	27
100-104	24	28
105-109	25	29
110-114	26	30
115-119	27	31
120-124	28	32
125-129	29	33
130-134	30	34
135-139	31	35
140-144	32	36
145-149	33	37
150-154	34	37
155-159	35	37
160-164	36	37
165-169	37	37
170-174	37	37
175-179	37	37
180 and above	37	37

†Also applies to diesel vehicles that meet the Real Driving Emissions Step 2 (RDE2). ††Applies to vehicles that do not meet the Real Driving Emissions Step 2 (RDE2).

To calculate your own personal liability, search: **Vauxhall BiK**, or click the link below: [Vauxhall BiK Tool](#)

Fleet Toolbox

Discover the facts in our online Toolbox for both Company Car Drivers and Fleet Decision Makers. The Fleet Toolbox has a host of useful calculators, comparators, interactive listings and information.

Search Vauxhall Fleet Tools or click the link below: [Vauxhall Fleet Tool Box](#)

Contact Vauxhall Fleet

Please contact one of our dedicated sales teams who will be happy to help with your particular enquiry.

Company Car Drivers

Call: 0345 111 2020

Email: company-car@vauxhallinfo.co.uk

Telephone lines are open

- Monday to Friday 8:00am-9:00pm

- Saturday and Sunday 9:00am-6:00pm

Fleet Decision Makers

Depending on the size of your fleet of vehicles, we have a dedicated team to handle your enquiries. The lines are open Monday to Friday excluding Bank Holidays.

1-24 vehicles

Call: 0845 076 2254 (8:30am-5:00pm)

25+ vehicles

Call: 0330 587 8222 (8:30am-5:00pm)

Email: vauxhallfleet@vauxhall.co.uk

Special Vehicles (Police, Fire and Ambulance)

Call: 01582 409999 (8:30am-5:00pm)

Email: vauxhallspecialvehicles@vauxhall.co.uk

For more information visit www.vauxhall.co.uk/fleet

FURTHER INFORMATION

On-the-road prices

To eliminate uncertainty about hidden costs when buying a new car, Vauxhall publishes on-the-road recommended retail prices (RRP) and these are shown in the pricing tables within this price guide. These prices include VAT, number plates and delivery to Retailer of £700.00 (including £116.67 VAT), 12 months' Government Vehicle Excise Duty (see opposite for details) and the DVLA new vehicle first registration fee of £55.00.*

Please note: The on-the-road recommended retail price (RRP) does not include fuel supplied by the Retailer, motor insurance or any other goods or services supplied by agreement between the Retailer and the customer.

Price protection

Order a new Vauxhall for build in the current model year (as confirmed by your Retailer) for delivery no more than three months in advance and the price you are quoted is the price you pay. This is irrespective of any subsequent price rises between placing your order and delivery of your new car, but you must take delivery as soon as the car is available. Vauxhall Motors Limited is not liable for price adjustments caused by Government changes in the rate of VAT (currently 20%), Vehicle Excise Duty, DVLA new vehicle first registration fee or by any other applicable legislation or regulations.

Vauxhall Finance Leasing

Vauxhall Finance Leasing is a trading style of Vauxhall Finance plc. Working with the Vauxhall Retailer network we provide competitive car and van leasing solutions for business users and private individuals. We combine the support of a national contract with the convenience of a local contact.

For further information, please contact your local Vauxhall Retailer or visit www.vauxhall.co.uk/leasing

In the event of an accident

Vauxhall Accident Management helps keep you mobile following an accident. Benefits include vehicle recovery, Vauxhall-approved repairs and contacting your insurer. For more details, visit www.vauxhall.co.uk/AccidentManagement

Vehicle Excise Duty

The amount of Vehicle Excise Duty (road fund licence) payable on new cars varies depending on the level of carbon dioxide (CO₂) emissions produced by the vehicle. CO₂ emissions are measured in grams per kilometre (g/km) travelled and divided into 13 charging bands shown in the table opposite.

A 'first year rate' of Vehicle Excise Duty is payable on all new cars and in subsequent years the amount payable reverts to the 'standard rate'. From 1 April 2017 the breakpoints for each of these bands have been revised. Also, for vehicles with a list price over £40,000, including factory-fitted options, an additional £320 is payable for the first five years of standard rate payments.

Vehicle Excise Duty*

Band	CO ₂ emissions in grams per kilometre	First year rate		Standard rate
		Petrol [#]	Diesel [†]	
A	0	£0	£0	£0
B	1-50	£10	£25	£145
C	51-75	£25	£110	£145
D	76-90	£110	£130	£145
E	91-100	£130	£150	£145
F	101-110	£150	£170	£145
G	111-130	£170	£210	£145
H	131-150	£210	£530	£145
I	151-170	£530	£855	£145
J	171-190	£855	£1,280	£145
K	191-225	£1,280	£1,815	£145
L	226-255	£1,815	£2,135	£145
M	over 255	£2,135	£2,135	£145

*Correct at time of issue.

[#]Also applies to diesel vehicles that meet the Real Driving Emissions Step 2 (RDE2).

[†]Applies to vehicles that do not meet the Real Driving Emissions Step 2 (RDE2).

FURTHER INFORMATION

Customer Care Commitment

For added peace of mind, Vauxhall has an innovative Customer Care Commitment that offers the following:

- Three-year vehicle warranty consisting of a one-year/unlimited mileage manufacturer's warranty and a second and third year manufacturer's warranty with a 60,000 miles limitation
- Vauxhall Assistance for 12 months from first registration
- Six years' body panel anti-perforation warranty

Please note: Warranty is only available on vehicles sourced from Vauxhall Motors Limited. Terms and conditions apply – please see your Vauxhall Retailer for details.

Vauxhall Assistance

Vauxhall Assistance is provided automatically with every new Vauxhall for 12 months from first registration and covers everything from accident assistance, roadside recovery and 'at home' service to flat tyres. With Vauxhall Assistance help is literally just a free* phone call away, 24 hours a day, 365 days a year!

Protecting the environment

Vauxhall's commitment to the environment is demonstrated by our products' many environmental awards. For even more information on Vauxhall's efforts to achieve an environmentally sustainable future, and how to dispose of your end-of-life vehicle, see www.vauxhall.co.uk/recycling

Vauxhall Service Plan

- Fixed monthly payments for the plan duration
- Easy to budget and interest-free
- Genuine parts fitted by Vauxhall-trained technicians

Plus on Gold plans:

- Valet and courtesy car
- Vauxhall Roadside Assistance
- Engine flush and fuel treatments
- Litre of oil for top ups between services

Full details can be obtained from your local participating Vauxhall Retailer.

Vauxhall Insurance with added reassurance

Comprehensive cover – Summary of benefits**

- Competitive premiums
- Repairs by a Vauxhall-trained technician
- Genuine Vauxhall parts, guaranteed for three years when we repair your car within our Approved Repairer Network
- Free courtesy car as standard when using an Approved Repairer†
- 24 hour claims helpline
- Personal Accident benefit
- Cover for audio equipment
- Windscreen cover

Call for a quote on 0844 463 2670††

For more product information

For further information on the Vauxhall range or location of your nearest Vauxhall Retailer please call **0345 600 1500**. Alternatively, details can be found on our website at www.vauxhall.co.uk

*Mobile phone users will be charged at their standard tariff.

**The benefits listed above are for comprehensive cover only. For details of Third Party, Fire and Theft cover, please call our sales team.

†Should your car need repairing following an accident we provide a courtesy car (subject to availability) for the duration of the repair. Only genuine Vauxhall parts are used. Terms and conditions apply.

††Calls may be recorded. Vauxhall Insurance is underwritten by Ageas Insurance Limited.

Take the next step:



Join us online:

Discover the full Vauxhall range at [vauxhall.co.uk](https://www.vauxhall.co.uk) >

Privacy Policy: For full details please visit [vauxhall.co.uk/privacy](https://www.vauxhall.co.uk/privacy)

The invoice price, including delivery to Retailer, factory-fitted options, accessories fitted by the Retailer and number plates, is subject to VAT. Some feature descriptions in this guide may refer to, and some illustrations may show, optional equipment not included in the standard delivery. The information contained in this guide was accurate at the time of publication. We reserve the right to make changes in design and equipment. Please note that Vauxhall Retailers are not the agents of Vauxhall Motors Limited and are not authorised to bind Vauxhall Motors Limited by any specific or implied undertaking or representation. It is advisable to ensure that your motor insurance policy provides adequate cover for additional fitted options and accessories. The colours in this guide are only approximate actual colours. Illustrated optional equipment is available at extra charge. Availability, technical features and equipment provided on our vehicles can vary by model. For precise information on the equipment provided on our vehicles, please contact your local Vauxhall Retailer.

NEW VIVARO LIFE

Price and Specification Guide | 4 June 2019 | Model Year 2020



VAUXHALL

British Brand since 1903

CONTENTS

To find the information you want use the links below to navigate around the guide:

[RANGE HIGHLIGHTS >](#)

Explore the New Vivaro Life range and find your perfect model.

[MODELS >](#)

Find all the information you need about your chosen model.

[PRICES >](#)

Find on-the-road recommended retail prices.

[FEATURES/OPTIONS >](#)

Tailor your chosen model to suit your needs with everything from satellite navigation to rear-view camera and parking sensors.

[EXTERIOR COLOURS >](#)

Add some sparkle to your car with a metallic paint.

[WHEELS AND TYRES >](#)

Check out the standard and optional wheel and tyre combinations.

[ENGINES >](#)

Includes power and torque figures plus service intervals.

[PERFORMANCE, FUEL ECONOMY AND EMISSIONS >](#)

Know how many miles you will get around town, the CO₂ figures and the 0-62 time.

[SPECIFICATIONS >](#)

Towing weights, transmissions and other useful details you may need to know.

[DIMENSIONS >](#)

Ensure your car will fit in the garage and know how much luggage you can take for a long weekend away.

[COMPANY CAR INFORMATION >](#)

Benefit in Kind company car tax, 3 day test drives and P11D.

[FURTHER INFORMATION >](#)

Price protection, vehicle excise duty, our range of additional products and much more.

NEW VIVARO LIFE RANGE HIGHLIGHTS



EDITION OTR from £27,760

Standard features include:

- Electronic stability programme
- Traction control
- ABS with electronic brakeforce distribution
- Hill start assist
- Driver and front passengers' airbag
- Remote control central deadlocking
- Selective door locking
- Electronic engine deadlock immobiliser
- Multi-function trip computer
- Cruise control with speed limiter
- Vauxhall Connect box
- Digital radio/AM/FM stereo radio
- Bluetooth® connectivity
- Steering column mounted audio and phone controls
- Single front passenger's seat
- Facia-mounted drinks holders
- Nearside and offside sliding side-access glazed doors
- Tailgate with wash/wipe and heated rear window
- Electrically operated front windows
- Electrically adjustable/heated door mirrors
- 16-inch steel wheels

ELITE OTR from £41,255

Features over Edition:

- Electrical operation of sliding side-access doors
- Multimedia Navi Pro infotainment unit with 3D satellite navigation system
- 7-inch colour touchscreen
- Head-up display
- One-touch up/down facility for front windows
- Leather seat trim
- Six-way electrically adjustable heated driver's seat with massage facility
- Four-way electrically adjustable heated passenger's seat with massage facility
- Dual-zone electronic climate control
- Roof-mounted rear heater controls
- Automatic parking heater
- Heat-reflective windscreen
- Rear parcel shelf
- Luggage floor net
- Rear seat back tables
- Rear-view child-minder mirror
- Rear side window blinds
- Remote control security alarm system
- Body-colour front and rear bumpers
- Chrome-effect front grille
- Front fog lights
- Rear-view camera
- Rain-sensitive windscreen wipers
- Electro-chromatic rear-view mirror
- LED daytime running lights
- Xenon headlights
- Dark-tinted rear windows
- Electrically folding door mirrors
- Side blind spot alert
- Front and rear parking distance sensors
- Panoramic glass roof
- Curtain airbags for second- and third-row passengers
- Tailgate with separate opening rear window
- Keyless open and start
- 17-inch bi-colour alloy wheels

EDITION



FEATURES

Infotainment:

- AM/FM/DAB digital radio
- Bluetooth® audio streaming
- Bluetooth® mobile phone portal
- USB audio connection

Interior convenience/styling:

- Multi-function trip computer
- Cruise control with speed limiter
- Vauxhall Connect box
- Steering column mounted audio and phone controls
- Single front passenger's seat

Please note: Edition models feature front row seating as standard. Additional rear seating can be specified as extra-cost options.

Exterior convenience/styling:

- Electrically adjustable/heated door mirrors
- Electrically operated front windows
- Nearside and offside sliding side-access glazed doors
- Tailgate with wash/wipe and heated rear window
- Side-protection mouldings

Safety/security:

- Driver and front passenger's airbags
- Driver and front passenger's curtain and side-impact airbags
- Height-adjustable lap and diagonal inertia-reel seatbelts
- Electronic stability programme with traction control
- Anti-lock braking system
- Tyre pressure monitoring system
- Hill start assist
- Daytime running lights
- Remote control central deadlocking
- Selective door locking
- Electronic engine deadlock immobiliser

EDITION M (MEDIUM) ON-THE-ROAD PRICES

	OTR RRP	CO ₂ (g/km)
Diesel		
1.5 (100PS) Turbo D S/S	£27,760	131

EDITION L (LONG) ON-THE-ROAD PRICES

	OTR RRP	CO ₂ (g/km)
Diesel		
1.5 (120PS) Turbo D S/S	£29,605	128

Please note: On-the-road recommended retail prices (RRP) include number plates and delivery to retailer of £583.33, 12 months' Vehicle Excise Duty and new vehicle first registration fee of £55.00. Excludes fuel and insurance.

S/S = Start/Stop.



Edition models standard front row seating.

ELITE



ELITE M (MEDIUM) ON-THE-ROAD PRICES

	OTR RRP	CO ₂ (g/km)
Diesel		
2.0 (150PS) Turbo D S/S	£41,255	149
2.0 (180PS) Turbo D S/S automatic	£41,910	151

ELITE L (LONG) ON-THE-ROAD PRICES

	OTR RRP	CO ₂ (g/km)
Diesel		
2.0 (150PS) Turbo D S/S	£42,420	152
2.0 (180PS) Turbo D S/S automatic	£42,750	151

Please note: On-the-road recommended retail prices (RRP) include number plates and delivery to retailer of £583.33, 12 months' Vehicle Excise Duty and new vehicle first registration fee of £55.00. Excludes fuel and insurance.

S/S = Start/Stop.

FEATURES

Infotainment:

- Multimedia Navi Pro
 - Fully integrated European sat nav system
 - 7-inch colour touchscreen
 - Voice control
 - AM/FM/DAB digital radio
 - Bluetooth® audio streaming
 - Bluetooth® mobile phone portal
 - USB audio connection
 - Second USB charging connection
 - Four speakers

Interior convenience/styling:

- Leather seat trim
- Six-way electrically adjustable heated driver's seat with massage facility
- Four-way electrically adjustable heated single front passenger's seat with massage facility
- Second-row three-passenger foldable 60/40 split bench seat
- Dual-zone electronic climate control
- Roof-mounted rear heater controls
- Automatic parking heater
- Electro-chromatic rear-view mirror
- Head-up display
- Multi-function trip computer
- Cruise control with speed limiter
- Vauxhall Connect box
- Steering column mounted audio and phone controls
- Rear-view child-minder mirror
- Rear seat back tables
- Rear side window blinds
- Rear parcel shelf
- Luggage floor net

Please note: See option pages to specify any third-row seating requirements.

Exterior convenience/styling:

- Heat-reflective windscreen
- Front fog lights
- Panoramic glass roof
- Rear-view camera
- Rain-sensitive windscreen wipers
- Xenon headlights.
- Keyless entry/engine start/stop
- Electrically adjustable/heated door mirrors
- Electrically folding door mirrors
- Electrically operated front windows with one-touch facility
- Nearside and offside sliding side-access glazed doors
- Hands-free electrical operation of sliding side-access doors
- Tailgate with wash/wipe and heated opening rear window
- Body-colour front and rear bumpers
- Chrome-effect front grille
- Side-protection mouldings
- 17-inch bi-colour alloy wheels

Safety/security:

- Side blind spot alert
- Driver and front passenger's airbags
- Curtain airbags for second- and third-row passengers
- Height-adjustable front lap and diagonal inertia-reel seatbelts
- Electronic stability programme with traction control
- Anti-lock braking system
- Hill start assist
- LED daytime running lights
- Remote control central deadlocking
- Selective door locking
- Electronic engine deadlock immobiliser
- Remote control security alarm system

NEW VIVARO LIFE PRICES

	Price (£)	VAT (£)	Total (£)	On-the-road RRP (£)	BiK 20% (£)	CO ₂ (g/km)
EDITION M (MEDIUM) EURO 6D TEMP (6.2)						
Diesel						
1.5 (100PS) Turbo D S/S	22,062.50	4,412.50	26,475.00	27,760.00	153.98	131
EDITION L (LONG) EURO 6D TEMP (6.2)						
Diesel						
1.5 (120PS) Turbo D S/S	23,866.67	4,773.33	28,640.00	29,605.00	161.37	128

	Price (£)	VAT (£)	Total (£)	On-the-road RRP (£)	BiK 20% (£)	CO ₂ (g/km)
ELITE M (MEDIUM) EURO 6D TEMP (6.2)						
Diesel						
2.0 (150PS) Turbo D S/S	33,308.33	6,661.67	39,970.00	41,255.00	250.78	149
2.0 (180PS) Turbo D S/S automatic	33,583.33	6,716.67	40,300.00	41,910.00	252.82	151
ELITE L (LONG) EURO 6D TEMP (6.2)						
Diesel						
2.0 (150PS) Turbo D S/S	34,008.33	6,801.67	40,810.00	42,420.00	255.97	152
2.0 (180PS) Turbo D S/S automatic	34,283.33	6,856.67	41,140.00	42,750.00	258.00	151

S/S = Start/Stop.

Please note: All New Vivaro models include BlueInjection. Vehicles with BlueInjection technology will need regular AdBlue® top-ups also between servicing requirements. An indicator integrated into the on-board computer will warn you when you need to top up. More information under www.vauxhall.co.uk/adblue. In accordance with regulations R (EC) No. 715/2007 and R (EC) No. 692/2008 (in the versions respectively applicable).

Please note: On-the-road recommended retail prices (RRP) include number plates and delivery to retailer of £700.00 (inc. £116.67 VAT), 12 months' Vehicle Excise Duty and new vehicle first registration fee of £55.00. Excludes fuel and insurance. Company Car Benefit in Kind (BiK) rates are monthly based on the standard paint price.

FEATURES/OPTIONS

SEATING

	Option code	Edition	Elite	Price (£) exc. VAT	Price (£) inc. VAT
Driver's and front passenger's seat • Reach • Backrest recline • Padded head restraint • Foldable backrest for front passenger's seat		●			
Dual front passengers' seat with underseat storage • Fixed position bench seat and backrest • Height-adjustable front padded head restraints	AGE	N/C		No-cost option	
Power driver's seat • Height • Reach • Backrest recline • Lumbar adjustment • Driver's seat armrest • Padded head restraint • Massage functions • Driver's seat memory function, including door mirrors			●		
Single front passenger's seat • Reach • Backrest recline • Padded head restraint • Folding backrest • Passenger's seat armrest • Massage functions • Driver's seat memory function, including door mirrors			●		

REAR SEATING

Second and third-row seating • Second-row three-passenger fixed bench seat	AN1	○		666.67	800.00
• Second-row three-passenger foldable 60/40 split bench seat • Third-row three-passenger fixed bench seat	AWL/ATJ	○		1,333.33	1,600.00
• Second-row three-passenger foldable 60/40 split bench seat			●		
• Third-row three-passenger foldable 60/40 split individually sliding bench /single seat	AWM		N/C	No-cost option	
• Two second-row individual swivelling seats	AW2		○	666.67	800.00
Foldable table on rails – Only in conjunction with AWM and AW2	TRD		○	412.50	495.00
Seat trim • Curitiba Tritone Grey fabric		●			
• Carla black vinyl	TAVP	○		tbc	tbc
• Carla black leather			●		

● = Standard equipment. ○ = Optional at extra cost. N/C = No-cost option.

FEATURES/OPTIONS

SAFETY

	Option code	Edition	Elite	Price (£) exc. VAT	Price (£) inc. VAT
Driver Safety Pack <ul style="list-style-type: none"> • Cruise control with intelligent speed adaptation • Forward collision alert with automatic emergency braking and pedestrian detection • 3.5-inch colour information display 	B26		○	375.00	450.00
Airbag Driver and front passengers airbag: <ul style="list-style-type: none"> • Driver and front passenger's airbag with deactivation switch • Driver and front passengers' curtain and side-impact airbags 		●			
Driver and front passenger's airbags: <ul style="list-style-type: none"> • Driver and front passenger's airbag with deactivation switch • Driver and passenger's side-impact airbags • Full-length curtain airbags (first-, second- and third-row seating) 			●		
Stability Electronic Stability Programme-plus (ESP-plus) with traction control – Works in conjunction with the vehicle's electronic braking and engine systems to keep the vehicle stable in many different situations. ESP monitors a variety of inputs to determine when the vehicle starts to lose traction, it can then immediately respond by varying the brake pressure between up to three wheels and adjust the engine output to help correct the loss of traction and improve stability.		●	●		
Tyre pressure <ul style="list-style-type: none"> • Tyre pressure monitoring system 		●	●		
Braking Four-channel Anti-lock Braking System (ABS) – Prevents the vehicle's wheels from locking up under heavy braking by momentarily reducing brake pressure at the appropriate wheel, ensuring that you can maintain control of the steering. Emergency brake assist – When emergency braking is detected the vehicle automatically applies the maximum possible braking assistance. Electronic brakeforce distribution – Automatically apportions the optimum braking force to each wheel. Hill start assist – Briefly maintains rear brake pressure to stop the vehicle rolling back on an incline.		●	●		

● = Standard equipment. ○ = Optional at extra cost.

FEATURES/OPTIONS

SECURITY

	Option code	Edition	Elite	Price (£) exc. VAT	Price (£) inc. VAT
Features • Electronic engine deadlock immobiliser • Steering column lock • Lockable fuel filler cap • Anti-theft spare wheel cradle		●	●		
Remote control door locking • Remote control door locking • Two keys with integral remote • Door deadlocks • Selective door locking		●	●		
Keyless open and start • Keyless open and start			●		
Security alarm system • Engine compartment protection • Ultrasonic detectors in load area • Siren	PS6	○	●	175.00	210.00

● = Standard equipment. ○ = Optional at extra cost.

FEATURES/OPTIONS

DRIVER ASSISTANCE

	Option code	Edition	Elite	Price (£) exc. VAT	Price (£) inc. VAT
Visibility Pack <ul style="list-style-type: none"> • Heat-reflective windscreen • Rain-sensitive windscreen wipers 	Y74	○	●	tbc	tbc
Driver Assistance Pack <ul style="list-style-type: none"> • Lane keep assist with lane departure warning • Speed Limit Information/Intelligent Speed Adaptation • Driver drowsiness system • White text Instrument panel • High beam assist 	E9A		○	500.00	600.00
Electric Pack <ul style="list-style-type: none"> • Foldable electrically adjustable/heated door mirrors – When front and rear parking distance sensors are fitted. • 12v socket in saloon area • Remote key with three buttons • Electrically operated front windows with one-touch up/down facility 		●	●		
Head-up display – Projects key information onto the windscreen so that the driver’s eyes remain on the road at all times. The display is adjustable for height and brightness.			●		
Multi-function trip computer <ul style="list-style-type: none"> • Trip odometer • Vehicle range based on remaining fuel • Average speed • Average fuel economy • Instantaneous fuel economy • Driving time 		●	●		
Parking assistance <ul style="list-style-type: none"> • Rear parking distance sensors 	UD7	○		183.33	220.00
<ul style="list-style-type: none"> • Front and rear parking distance sensors • Side blind spot alert • Front fog lights • Electrically folding door mirrors 	UD5	○	●	541.67	650.00
<ul style="list-style-type: none"> • Rear-view camera – requires UD7. Not available with Multimedia infotainment system (i05) 	UVC	○		tbc	tbc
<ul style="list-style-type: none"> • Panoramic rear-view camera 			●		
Cruise control, speed limiter		●	●		
Instrumentation <ul style="list-style-type: none"> • Speedometer • Rev counter • Fuel gauge with low fuel warning light • Fuel economy gauge • Coolant temperature warning light 		●	●		

● = Standard equipment. ○ = Optional at extra cost.

FEATURES/OPTIONS

DRIVER ASSISTANCE CONTINUED

	Option code	Edition	Elite	Price (£) exc. VAT	Price (£) inc. VAT
<p>IntelliGrip Pack</p> <p>For those drivers who regularly take their vehicle off road, this pack helps the driver cope with whatever conditions they encounter. IntelliGrip traction control is designed to increase grip in difficult conditions without the additional weight of a conventional four-wheel drive system. It's an innovative grip control system that provides improved traction on certain terrain and conditions through a combination of optimised torque distribution and limited wheel spin, managed through the electronic stability programme.</p> <ul style="list-style-type: none"> • IntelliGrip: A choice of five selectable modes to suit the driving conditions: ESP on, ESP off, snow, mud, sand - Only available when 17-inch wheels are specified for Edition models. 	H4H	○	○	200.00	240.00

COMFORT AND CONVENIENCE

<p>Comfort</p> <ul style="list-style-type: none"> • Reach and rake-adjustable steering wheel • Facia-mounted gear lever • Floor-mounted handbrake lever • Inertia-reel lap and diagonal seatbelts • Height-adjustable outer front seatbelts • Height-adjustable padded head restraints • Rear parcel shelf 		●			
<ul style="list-style-type: none"> • Load area restraint net • Luggage floor net • Rear seat back tables • Rear-view child-minder mirror • Rear side-window blinds • Torch stowed in rear luggage area panel • 220 volt socket behind driver's seat 			●		
Leather-covered steering wheel			●		

● = Standard equipment. ○ = Optional at extra cost.

FEATURES/OPTIONS

INFOTAINMENT

	Option code	Edition	Elite	Price (£) exc. VAT	Price (£) inc. VAT
<p>Radio BT</p> <p>Onboard features:</p> <ul style="list-style-type: none"> • AM/FM stereo radio • DAB Digital radio • RDS with Traffic Programme • 20 watts per channel output • Four speakers <p>Media connections:</p> <ul style="list-style-type: none"> • USB connection with iPod control • Bluetooth® A2DP audio streaming (Advanced Audio Distribution Profile) <p>Mobile phone portal:</p> <ul style="list-style-type: none"> • Bluetooth® connectivity • Handsfree calls via steering wheel controls • Vehicle microphone 		●			
<p>Multimedia</p> <p>Onboard features:</p> <ul style="list-style-type: none"> • 7-inch colour touchscreen • AM/FM stereo radio with 25 Station presets • DAB Digital radio • RDS with Traffic Programme • 20 watts per channel output • Four speakers <p>Media connections:</p> <ul style="list-style-type: none"> • USB connection with iPod control • Bluetooth® A2DP audio streaming (Advanced Audio Distribution Profile) <p>Mobile phone portal:</p> <ul style="list-style-type: none"> • Bluetooth® connectivity • Handsfree calls via steering wheel controls • Vehicle microphone • Phone book access – Contacts/last calls/missed calls etc. are mirrored on the display and are easily navigated using the touchscreen (features dependent on mobile phone). • Bluetooth® connectivity • Handsfree calls via steering wheel controls • Vehicle microphone <p>Smartphone interface:</p> <ul style="list-style-type: none"> • Apple CarPlay™ • Android Auto™ – Smartphone projection that allows operations via voice command, touchscreen and buttons to control apps and music playback. 	i05	○		400.00	480.00

● = Standard equipment. ○ = Optional at extra cost.

FEATURES/OPTIONS

INFOTAINMENT CONTINUED

	Option code	Edition	Elite	Price (£) exc. VAT	Price (£) inc. VAT
Multimedia Navi Pro Onboard features: <ul style="list-style-type: none"> • 7-inch colour touchscreen • AM/FM stereo radio with 15 Station presets • DAB Digital radio • RDS with Traffic Programme • 20 watts per channel output • Ten speakers Navigation features: <ul style="list-style-type: none"> • Satellite navigation system • 3D street level mapping • European coverage • Structured or one-box destination entry • Points-of-interest search • Eco routing • Map updates via USB Wi-fi enabled connected navigation features: <ul style="list-style-type: none"> • Three years subscription to TomTom Live* • On-line navigation services provided by TomTom® include: <ul style="list-style-type: none"> • TomTom® live traffic updates • Local weather information • Nearby fuel station display • Local address search and contact info for points of interest Media connections: <ul style="list-style-type: none"> • USB connection with iPod control • Bluetooth® A2DP audio streaming (Advanced Audio Distribution Profile) Mobile phone portal: <ul style="list-style-type: none"> • Bluetooth® connectivity • Handsfree calls via steering wheel controls • Vehicle microphone • Phone book access – Contacts/last calls/missed calls etc. are mirrored on the display and are easily navigated using the touchscreen (features dependent on mobile phone). Smartphone interface: <ul style="list-style-type: none"> • Apple CarPlay™ • Android Auto™ – Smartphone projection that allows operations via voice command, touchscreen and buttons to control apps and music playback. 			●		
Additional features <ul style="list-style-type: none"> • Steering column mounted audio controls • Flexible roof-mounted aerial 		●	●		
Four speakers		●			
Ten speakers (HiFi Pack)			●		

● = Standard equipment. ○ = Optional at extra cost.

FEATURES/OPTIONS

HEATING AND VENTILATION

	Option code	Edition	Elite	Price (£) exc. VAT	Price (£) inc. VAT
Air conditioning • Air recirculation facility • Pollen filter • Illuminated controls • Chilled glovebox facility	C60	○	●	750.00	900.00
Electronic climate control • LCD temperature display • Automatic air direction and fan speed with manual override • Illuminated controls • Pollen filter • Chilled glovebox facility			●		
Rear air conditioning • Multi-function overhead panel with separate controls for the rear cabin • Six multi-function air nozzles • Fixed side air vents			●		
Automatic parking heater			●		

LOAD ACCESS

Nearside and offside access Nearside and offside sliding side-access door with fixed windows: • Fixed window to nearside side-access door • Fixed window to offside side-access door			●	●	
Handsfree electrically operated sliding side-access doors: • Keyless open and start • Auto anti-dazzle rear-view mirror				●	
Rear access Rear glazed doors: • Glazed rear doors • 90°/180° opening • Heated rear windows with wash/wipe facility	J1X	○		200.00	240.00
Tailgate: • Glazed tailgate • Heated rear windows with wash/wipe facility			●		
• Glazed tailgate with opening window • Heated rear windows with wash/wipe facility				●	
Vertical safety net	APT	○	○	100.00	120.00

● = Standard equipment. ○ = Optional at extra cost.

FEATURES/OPTIONS

EXTERIOR LIGHTING

	Option code	Edition	Elite	Price (£) exc. VAT	Price (£) inc. VAT
Standard lighting • Lights-on audible warning • Reversing lights • Hazard warning lights • Rear fog lights • High-level brake light • Side-repeat indicators • Daytime running lights – LED on Elite models.		●	●		
• Xenon headlights			●		

EXTERIOR CONVENIENCE/STYLING

Appearance Pack • Body-colour front and rear bumpers • Body-colour mirror housings and door handles • Body-colour side-protection mouldings • Chrome-effect front grille • Front fog lights • LED daytime running lights lights			●		
Full-length panoramic glass sunroof with manually-sliding sunblinds			●		
Dark-tinted rear glazing (opacity level approximately 70%)	AKO	○	●	100.00	120.00
Conversions Connector for conversions	WRF	○		90.00	108.00

● = Standard equipment. ○ = Optional at extra cost.



FEATURES/OPTIONS

TOWING

	Option code	Edition	Elite	Price (£) exc. VAT	Price (£) inc. VAT
 <p>Tow bar</p> <ul style="list-style-type: none"> • Removable monoblock towing ball with tool (ball) • Provison for tow bar • Towing connector 	V76	○	○	333.33	400.00
 <p>Tow bar</p> <ul style="list-style-type: none"> • Removable monoblock towing ball without tool • Provison for tow bar • Towing connector 	VQ9	○	○	250.00	300.00
 <p>Tow bar</p> <ul style="list-style-type: none"> • Removable gooseneck towing ball with tool • Provison for tow bar • Towing connector 	V65	○	○	200.00	240.00

● = Standard equipment. ○ = Optional at extra cost.

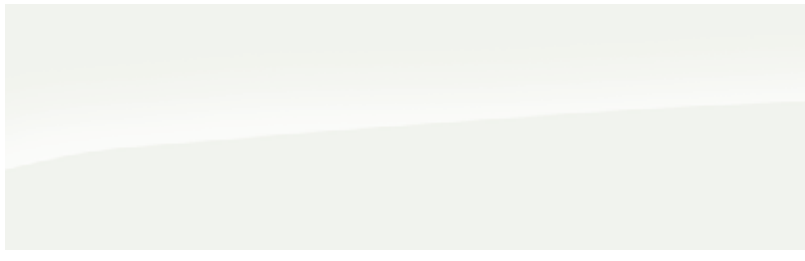
EXTERIOR COLOURS

				Edition	Elite	Price (£) exc. VAT	Price (£) inc. VAT
Solid		Jade White (G2o)		●	●		
		Brilliant		Flaming Red (GE0)		○	
Two-coat				Moonstone Grey metallic (G4o)	Quartz Grey metallic (G4i)	○	○
		Cool Grey metallic (GAC)	Amber Red metallic (GoX)				
		Rich Oak Brown metallic (GoJ)	Diamond Black metallic (G7o)				

The colours reproduced may vary slightly from the actual paint colour. As a result they should be used as a guide only. Your Vauxhall Retailer has a comprehensive display of our paint samples.

● = Standard equipment. ○ = Optional at extra cost.

WHEELS AND TYRES

	Option code	Edition	Elite	Price (£) exc. VAT	Price (£) inc. VAT
Full-size spare wheel		●	●		
All-season tyres • 215/60 R 17 – Only available when 17-inch wheels are specified.	Q40	○	○	166.67	200.00
Tyre inflation kit in lieu of spare wheel	KTi	N/C	N/C	No-cost option	
 16-inch steel wheels with centre cap • 215/65 R 16 tyres		●			
 17-inch diamond-cut alloy wheels • 215/60 R 17 tyres • Locking wheel bolts			●		
 17-inch steel wheels with centre cap • 215/60 R 17 tyres	RS9	○		166.67	200.00

● = Standard equipment. ○ = Optional at extra cost. N/C = No-cost option.

DIESEL ENGINES

Engine	1.5 (100PS) Turbo D Start/Stop BlueInjection	1.5 (120PS) Turbo D Start/Stop BlueInjection	2.0 (120PS) Turbo D Start/Stop BlueInjection
Capacity	1499cc	1499cc	1997cc
Maximum power	100PS (75kW) @ 3500rpm	120PS (88kW) @ 3500rpm	120PS (88kW) @ 3500rpm
Maximum torque	270Nm (184 lb.ft.) @ 1600rpm	300Nm (221 lb.ft.) @ 1750rpm	340Nm (251 lb.ft.) @ 2000rpm
Configuration	4 cylinders, 4 valves per cylinder, double overhead camshafts	4 cylinders, 4 valves per cylinder, double overhead camshafts	4 cylinders, 4 valves per cylinder, double overhead camshafts
Emission compliance	Euro 6D TEMP (6.2)	Euro 6D TEMP (6.2)	Euro 6D TEMP (6.2)
Service interval	25,000 miles or 2 years (whichever occurs sooner)	25,000 miles or 2 years (whichever occurs sooner)	30,000 miles or 2 years (whichever occurs sooner)



Engine	2.0 (150PS) Turbo D Start/Stop BlueInjection	2.0 (180PS) Turbo D Start/Stop BlueInjection
Capacity	1997cc	1997cc
Maximum power	150PS (110kW) @ 3500rpm	180PS (130kW) @ 3500rpm
Maximum torque	370Nm (273 lb.ft.) @ 2000rpm	400Nm (295 lb.ft.) @ 2000rpm
Configuration	4 cylinders, 4 valves per cylinder, double overhead camshafts	4 cylinders, 4 valves per cylinder, double overhead camshafts
Emission compliance	Euro 6D TEMP (6.2)	Euro 6D TEMP (6.2)
Service interval	30,000 miles or 2 years (whichever occurs sooner)	30,000 miles or 2 years (whichever occurs sooner)

Vehicles with BlueInjection technology will need regular AdBlue® top-ups also between servicing requirements. An indicator integrated into the on-board computer will warn you when you need to top up. More information under www.vauxhall.co.uk/adblue. In accordance with regulations R (EC) No. 715/2007 and R (EC) No. 692/2008 (in the versions respectively applicable).

PERFORMANCE, FUEL ECONOMY AND EMISSIONS

	Performance (manufacturer's figures)			Fuel economy mpg (litres/100km)#		CO ₂ emissions g/km*	Vehicle Excise Duty*		Benefit in kind company car taxation rates - 2019/20 tax year
	Wheel size (inches)	Maximum speed (mph)	Acceleration 0-62mph (sec)	Combined Low	Combined High		First year rate	Standard rate	
Manual									
1.5 (100PS) Turbo D Start/Stop	16	91	17.1	39.2 (7.2)	46.6 (6.1)	131	£530	£145	34%
1.5 (120PS) Turbo D Start/Stop	16	100	14.3	39.2 (7.2)	47.1 (6.0)	128	£210	£145	33%
2.0 (150PS) Turbo D Start/Stop	17	105	12.0	35.3 (8.0)	41.5 (6.8)	149/152	£530	£145	37%
Automatic									
2.0 (180PS) Turbo D Start/Stop	17	105	10.4	34.8 (8.1)	40.6 (7.0)	151	£855	£145	37%

Tyre Rating

Tyre size	Type	Fuel efficiency group	Wet grip performance	External noise	
				Measured (dB)	Group
215/65 R 16	Summer	C	A	72	
215/60 R 17	Summer IntelliGrip	C	A	72	
215/60 R 17	All season	E	B	71	

Tyre rating according to EU Regulation 1222/2009

#Fuel consumption figures are determined according to the WLTP test cycle. Full data relating to WLTP test cycles can be found at: www.vauxhall.co.uk/wltp

*CO₂ emissions figures are determined according to the WLTP test cycle however, a Government formula is then applied to translate these figures back to what they would have been under the outgoing NEDC test cycle, which WLTP replaces. The correct tax treatment is then applied.

Figures are intended for comparability purposes only. The fuel consumption you achieve under real life driving conditions and CO₂ produced will depend upon a number of factors, including the accessories fitted after registration, variations in driving styles, weather conditions and vehicle load. Only compare fuel consumption and CO₂ with other vehicles tested using the same technical procedures. For more information contact your local Vauxhall Retailer.

**Correct at time of publication.

SPECIFICATIONS

Transmission

Six-speed manual gearbox:

- Front-wheel drive • Transverse engine/gearbox

Eight-speed automatic transmission:

- Front-wheel drive • Transverse engine/gearbox

Replacing the traditional lever, the automatic transmission selection-mode dial/drive wheel is an innovation solution that is both elegant and intuitive.

By simply twisting the dial, the following modes can be selected:

- Park, for when the vehicle is stationary and the wheels are locked
- Drive, for automatic forward motion
- Neutral, for when the vehicle is stationary, wheels are free
- Reverse, for automatic backward motion

For an extra experience of dynamism, the shift paddles for automatic transmissions are located behind the steering wheel, offering drivers an extra level of control that is highly ergonomic and intuitive. The shift paddles function in the following way:

- To go up a gear, the driver must pull the right lever towards themselves
- To go down a gear, the driver must pull the left lever towards themselves – Please note: only consecutive gear changes are possible.

Steering

- Hydraulic power-assisted rack and pinion system
- Energy absorbing steering column
- Turning circle (kerb-to-kerb): 12.4m (40.7ft.)

Brakes

Front ventilated disc brakes:

- 304mm x 28mm

Rear disc brakes:

- 290mm x 12mm

Fuel tank capacity

- 70 litres (15.4 gallons)

Adblue® tank capacity

- 22.5 litres (4.95 gallons)

Start/stop technology

New Vivaro Life's Start/Stop system, fitted as standard to all models offers real benefits by improving fuel economy and reducing CO₂ emissions, particularly in town. It does this by automatically stopping the engine when you come to a standstill, and then restarting as you prepare to move off.

Before automatically stopping the engine a number of system checks are carried out to ensure that it is both safe and practical to do so. To ensure safety, the driver must depress the clutch pedal, shift in to neutral, and then release the clutch pedal. System checks carried out before Auto Stop activates include:

- Start/Stop system is not manually deactivated via the facia button
- Sufficient brake vacuum is available to prevent the car rolling down an incline
- Battery is in good condition and charged
- Outside air temperature and engine temperature are above specified minima
- Electronic climate control (where fitted) is not in maximum heating or maximum cooling mode
- Self-cleaning function of the diesel particulate filter is not active

If all of these conditions are satisfied then the vehicle will Auto Stop.

When you are ready to pull away from standstill, Auto Restart is activated by depressing the clutch pedal.

Whilst at a standstill the vehicle is continually monitored. If necessary, the engine will automatically be restarted. Conditions that would initiate an Auto Restart include:

- Low battery level
- Brake vacuum below specified minimum
- Start/Stop system is manually deactivated
- Stationary for 5.5 minutes

Weights and Towing Data kg

	Gross vehicle weight	Maximum towing weights Trailer with brakes
LIFE EDITION M (MEDIUM) EURO 6D TEMP (6.2)		
1.5 (100PS) Turbo D S/S	2830	1400
LIFE ELITE M (MEDIUM) EURO 6D TEMP (6.2)		
2.0 (150PS) Turbo D S/S	3100	1900
2.0 (180PS) Turbo D S/S automatic	3100	1800
LIFE EDITION L (LONG) EURO 6D TEMP (6.2)		
1.5 (120PS) Turbo D S/S	2830	1400
LIFE ELITE L (LONG) EURO 6D TEMP (6.2)		
2.0 (150PS) Turbo D S/S	3100	1900
2.0 (180PS) Turbo D S/S automatic	3100	1800

S/S = Start/Stop.

Gross vehicle weight is the total permissible weight of the vehicle including passengers and their luggage. The maximum roof rack loading should not exceed 170kg on all models. The maximum towing weights are based on the ability of the car, with two occupants of 75kg each, to restart on a 12% gradient, which is approximately 1 in 8.3, at sea level. The permitted trailer load applies up to the specified incline and up to an altitude of 1000 metres above sea level. The permissible gross train weight decreases by 10% for every 1000 metres of additional altitude. Any extra weight, such as luggage or additional passengers, should be deducted from the maximum towing weight. Always fit Vauxhall towing attachments and accessories available from your Vauxhall Retailer. They are designed specifically for Vauxhall models and carry a 12-month guarantee. During trailer towing do not exceed a maximum speed of 60mph. This speed limit is also applicable in countries with higher permitted speeds for trailer-vehicle combinations. Pay attention to the local speed limits. For trailers with low driving stability and caravans the use of an oscillation damper is strongly recommended.

DIMENSIONS

Loadspace Dimensions millimetres (inches)	M (MEDIUM)	L (LONG)
Maximum load length – Passenger’s seat folded	3161 (124.5)	3511 (138.2)
Maximum load length – Behind front seats	2413 (95.0)	2763 (108.8)
Maximum width	1618 (63.7)	1618 (63.7)
Width between wheel arches	1228 (48.3)	1228 (48.3)
Maximum height	1337 (52.6)	1339 (52.7)
Loadspace Access millimetres (inches)		
Side door aperture height	1181 (46.5)	1181 (46.5)
Side door aperture width	933 (36.7)	933 (36.7)
Rear door aperture height	1181 (46.5)	1181 (46.5)
Rear door aperture width	1212 (47.7)	1212 (47.7)
Loading height – Maximum	653 (25.7)	664 (26.1)
Loading height – Minimum	584 (23.0)	584 (23.0)

Loadspace Volumes cu.m (cu.ft.)	M (MEDIUM)	L (LONG)
Maximum volume to roof level	3.9 (137.7)	4.5 (158.9)
Maximum volume to seat back level	3.0 (105.9)	3.5 (123.6)
Exterior dimensions millimetres (inches)		
Overall length	4956 (195.1)	5306 (208.9)
Width – including door mirrors	2204 (86.8)	2204 (86.8)
Width – excluding door mirrors	1920 (75.6)	1920 (75.6)
Height – manual models	1925 (75.8)	1925 (75.8)
Height – automatic models	1935 (76.2)	1935 (76.2)
Wheelbase	3275 (129.0)	3275 (129.0)
Front overhang	881 (34.7)	881 (34.7)
Rear overhang	803 (31.6)	1153 (45.4)

COMPANY CAR DRIVER AND FLEET INFORMATION

Design and Tech Line High Spec Low P11D

Specifically developed for businesses and company car drivers alike, our Design and Tech Line Nav models are seriously fit for Fleet.

Design models all feature very low P11D values, generous standard specification, including Sat Nav on Design Nav models, and a choice of high tech ecoTEC engines for great fuel economy and low emissions.

For even more standard specification, step up to our Tech Line Nav range. Again you are guaranteed low P11D values, plus great standard kit including Sat Nav, Bluetooth®, USB connection, aux-in socket and digital radio.

With Design and Tech Line Nav you can take for granted low Whole Life Costs and low company car driver taxation.

Company Car Driver Free 3 Day Test Drive

Our free* 3 Day Test Drive programme is open to all Company Car Drivers which allows you to choose any model in the current Vauxhall line-up (exclusions apply). With full insurance cover provided, it gives you a meaningful length of time to make an informed decision about your next company car.

Search Vauxhall 3DTD to book your FREE* test drive or click the link the below:

[Vauxhall 3 Day Test Drive](#)

*The free 3 Day Test Drive programme is open to Company Car Drivers and Fleet Decision Makers. Available for UK Mainland only. Terms and conditions apply. Full terms and conditions can be found at vauxhallfleet.co.uk/testdrive/index/terms.

Benefit in kind company car taxation†

The car benefit charge will be the car's list price (including VAT, options and accessories fitted, delivery to Retailer and number plates, but excluding Vehicle Excise Duty and new vehicle first registration fee) multiplied by the percentage charge for the CO₂ emissions band in which the car falls (see table opposite). Multiply this figure by your personal income tax rate (20%^{††} for Basic Rate, 40%^{††} for Higher Rate) to calculate your annual benefit in kind tax liability.

Example:

New Vivaro Life Edition L 1.5 (120PS) Turbo D Start/Stop (CO₂ emissions 128g/km)	
On-the-road RRP	£29,605.00
Deduct: Vehicle Excise Duty	(£210.00)
New vehicle first registration fee	(£55.00)
Effective list price	£29,340.00
Add: Optional two-coat metallic paint	£545.00
List price for tax purposes (P11D value)	£29,885.00
Car benefit charge 2019–20 tax year (33%)	£9,862.00
Benefit in kind tax liability (2019–20 tax year)	
Basic Rate (20%) tax payer	£1,972.40
Higher Rate (40%) tax payer	£3,944.80

†Please note this Price Guide provides taxation information as a guide only. Vauxhall does not provide taxation guidance. Drivers should always take professional advice on their own tax position.

††Excludes residents of Scotland.

BIK FOR SCOTTISH RESIDENTS

Effective 6 April 2018 the Scottish Government have introduced their own BIK taxation structure. This only applies to Company Car Drivers that are Scottish taxpayers. HMRC will determine whether or not an individual is a Scottish taxpayer based on where their main place of residence is.

The BIK rates for Scotland are:

- Over £12,500–£14,549 Starter Rate 19%
- Over £14,549–£24,994 Basic Rate 20%
- Over £24,994–£43,430 Intermediate Rate 21%
- Over £43,430–£150,000 Higher Rate 41%
- Above £150,000 Top Rate 46%

Benefit in kind company car taxation table

CO ₂ emissions in grams per kilometre	Percentage of cars price to be taxed	
	Non-Diesel [‡] 2019-20 tax year	Diesel ^{‡‡} 2019-20 tax year
Up to 50	16	20
51-75	19	23
76-94	22	26
95-99	23	27
100-104	24	28
105-109	25	29
110-114	26	30
115-119	27	31
120-124	28	32
125-129	29	33
130-134	30	34
135-139	31	35
140-144	32	36
145-149	33	37
150-154	34	37
155-159	35	37
160-164	36	37
165-169	37	37
170-174	37	37
175-179	37	37
180 and above	37	37

[‡]Also applies to diesel vehicles that meet the Real Driving Emissions Step 2 (RDE2). ^{‡‡}Applies to vehicles that do not meet the Real Driving Emissions Step 2 (RDE2).

To calculate your own personal liability, search: **Vauxhall BiK**, or click the link below: [Vauxhall BiK Tool](#)

Fleet Toolbox

Discover the facts in our online Toolbox for both Company Car Drivers and Fleet Decision Makers. The Fleet Toolbox has a host of useful calculators, comparators, interactive listings and information.

Search Vauxhall Fleet Tools or click the link below: [Vauxhall Fleet Tool Box](#)

Contact Vauxhall Fleet

Please contact one of our dedicated sales teams who will be happy to help with your particular enquiry.

Company Car Drivers

Call: 0345 111 2020

Email: company-car@vauxhallinfo.co.uk

Telephone lines are open

– Monday to Friday 8:00am–9:00pm

– Saturday and Sunday 9:00am–6:00pm

Fleet Decision Makers

Depending on the size of your fleet of vehicles, we have a dedicated team to handle your enquiries. The lines are open Monday to Friday excluding Bank Holidays.

1-24 vehicles

Call: 0845 076 2254 (8:30am–5:00pm)

25+ vehicles

Call: 0330 587 8222 (8:30am–5:00pm)

Email: vauxhallfleet@vauxhall.co.uk

Special Vehicles (Police, Fire and Ambulance)

Call: 01582 409999 (8:30am–5:00pm)

Email: vauxhallspecialvehicles@vauxhall.co.uk

For more information visit www.vauxhall.co.uk/fleet

FURTHER INFORMATION

On-the-road prices

To eliminate uncertainty about hidden costs when buying a new car, Vauxhall publishes on-the-road recommended retail prices (RRP) and these are shown in the pricing tables within this price guide. These prices include VAT, number plates and delivery to Retailer of £700.00 (including £116.67 VAT), 12 months' Government Vehicle Excise Duty (see opposite for details) and the DVLA new vehicle first registration fee of £55.00.*

Please note: The on-the-road recommended retail price (RRP) does not include fuel supplied by the Retailer, motor insurance or any other goods or services supplied by agreement between the Retailer and the customer.

Price protection

Order a new Vauxhall for build in the current model year (as confirmed by your Retailer) for delivery no more than three months in advance and the price you are quoted is the price you pay. This is irrespective of any subsequent price rises between placing your order and delivery of your new car, but you must take delivery as soon as the car is available. Vauxhall Motors Limited is not liable for price adjustments caused by Government changes in the rate of VAT (currently 20%), Vehicle Excise Duty, DVLA new vehicle first registration fee or by any other applicable legislation or regulations.

Vauxhall Finance Leasing

Vauxhall Finance Leasing is a trading style of Vauxhall Finance plc. Working with the Vauxhall Retailer network we provide competitive car and van leasing solutions for business users and private individuals. We combine the support of a national contract with the convenience of a local contact.

For further information, please contact your local Vauxhall Retailer or visit www.vauxhall.co.uk/leasing

In the event of an accident

Vauxhall Accident Management helps keep you mobile following an accident. Benefits include vehicle recovery, Vauxhall-approved repairs and contacting your insurer. For more details, visit www.vauxhall.co.uk/AccidentManagement

Vehicle Excise Duty

The amount of Vehicle Excise Duty (road fund licence) payable on new cars varies depending on the level of carbon dioxide (CO₂) emissions produced by the vehicle. CO₂ emissions are measured in grams per kilometre (g/km) travelled and divided into 13 charging bands shown in the table opposite.

A 'first year rate' of Vehicle Excise Duty is payable on all new cars and in subsequent years the amount payable reverts to the 'standard rate'. From 1 April 2017 the breakpoints for each of these bands have been revised. Also, for vehicles with a list price over £40,000, including factory-fitted options, an additional £320 is payable for the first five years of standard rate payments.

Vehicle Excise Duty*

Band	CO ₂ emissions in grams per kilometre	First year rate		Standard rate
		Petrol [#]	Diesel [†]	
A	0	£0	£0	£0
B	1-50	£10	£25	£145
C	51-75	£25	£110	£145
D	76-90	£110	£130	£145
E	91-100	£130	£150	£145
F	101-110	£150	£170	£145
G	111-130	£170	£210	£145
H	131-150	£210	£530	£145
I	151-170	£530	£855	£145
J	171-190	£855	£1,280	£145
K	191-225	£1,280	£1,815	£145
L	226-255	£1,815	£2,135	£145
M	over 255	£2,135	£2,135	£145

*Correct at time of issue.

[#]Also applies to diesel vehicles that meet the Real Driving Emissions Step 2 (RDE2).

[†]Applies to vehicles that do not meet the Real Driving Emissions Step 2 (RDE2).

FURTHER INFORMATION

Customer Care Commitment

For added peace of mind, Vauxhall has an innovative Customer Care Commitment that offers the following:

- Three-year vehicle warranty consisting of a one-year/unlimited mileage manufacturer's warranty and a second and third year manufacturer's warranty with a 60,000 miles limitation
- Vauxhall Assistance for 12 months from first registration
- Six years' body panel anti-perforation warranty

Please note: Warranty is only available on vehicles sourced from Vauxhall Motors Limited. Terms and conditions apply – please see your Vauxhall Retailer for details.

Vauxhall Assistance

Vauxhall Assistance is provided automatically with every new Vauxhall for 12 months from first registration and covers everything from accident assistance, roadside recovery and 'at home' service to flat tyres. With Vauxhall Assistance help is literally just a free* phone call away, 24 hours a day, 365 days a year!

Protecting the environment

Vauxhall's commitment to the environment is demonstrated by our products' many environmental awards. For even more information on Vauxhall's efforts to achieve an environmentally sustainable future, and how to dispose of your end-of-life vehicle, see www.vauxhall.co.uk/recycling

Vauxhall Service Plan

- Fixed monthly payments for the plan duration
- Easy to budget and interest-free
- Genuine parts fitted by Vauxhall-trained technicians

Plus on Gold plans:

- Valet and courtesy car
- Vauxhall Roadside Assistance
- Engine flush and fuel treatments
- Litre of oil for top ups between services

Full details can be obtained from your local participating Vauxhall Retailer.

Vauxhall Insurance with added reassurance

Comprehensive cover – Summary of benefits**

- Competitive premiums
- Repairs by a Vauxhall-trained technician
- Genuine Vauxhall parts, guaranteed for three years when we repair your car within our Approved Repairer Network
- Free courtesy car as standard when using an Approved Repairer†
- 24 hour claims helpline
- Personal Accident benefit
- Cover for audio equipment
- Windscreen cover

Call for a quote on 0844 463 2670††

Conversions

Vauxhall's integration within the PSA Group has brought significant benefits, and this is especially true of light commercial vehicles. PSA Group is Europe's largest manufacturer of light commercial vehicles and has a definitive strategy in place to further strengthen this position.

One aspect of this strategy is the new conversion portal for all PSA Group brands. This significantly improves the transparency and response of all communication with body-builders, and converters:

www.converters-and-groupe-psa.com

This website contains complete technical guidelines necessary to convert Vauxhall commercial vehicles – New Combo (K9), New Vivaro (K0) and Movano (X62). All vital and fundamental information is now located in one place:

- Conversion Guidelines
- Technical Data
- 3D CAD (coming)
- WLTP guidance
- Body shell ordering

Additionally there is a new Q&A service for technical questions, and the new conversion approval process will also be managed through this portal.

Any converter of Vauxhall product should create an account on this portal including those using IVA as approval process. In fact WLTP will make this necessary.

The Vauxhall data repository (on VX website) has now been closed, and any visitors are referred to the new site.

For more product information

For further information on the Vauxhall range or location of your nearest Vauxhall Retailer please call **0345 600 1500**. Alternatively, details can be found on our website at www.vauxhall.co.uk

*Mobile phone users will be charged at their standard tariff.

**The benefits listed above are for comprehensive cover only. For details of Third Party, Fire and Theft cover, please call our sales team.

†Should your car need repairing following an accident we provide a courtesy car (subject to availability) for the duration of the repair. Only genuine Vauxhall parts are used. Terms and conditions apply.

††Calls may be recorded. Vauxhall Insurance is underwritten by Ageas Insurance Limited.

Take the next step:



Join us online:

Discover the full Vauxhall range at [vauxhall.co.uk](https://www.vauxhall.co.uk) >

Privacy Policy: For full details please visit [vauxhall.co.uk/privacy](https://www.vauxhall.co.uk/privacy)

The invoice price, including delivery to Retailer, factory-fitted options, accessories fitted by the Retailer and number plates, is subject to VAT. Some feature descriptions in this guide may refer to, and some illustrations may show, optional equipment not included in the standard delivery. The information contained in this guide was accurate at the time of publication. We reserve the right to make changes in design and equipment. Please note that Vauxhall Retailers are not the agents of Vauxhall Motors Limited and are not authorised to bind Vauxhall Motors Limited by any specific or implied undertaking or representation. It is advisable to ensure that your motor insurance policy provides adequate cover for additional fitted options and accessories. The colours in this guide are only approximate actual colours. Illustrated optional equipment is available at extra charge. Availability, technical features and equipment provided on our vehicles can vary by model. For precise information on the equipment provided on our vehicles, please contact your local Vauxhall Retailer.