



# VIVA

Price and Specification Guide | 5 April 2018 | Model Year 2019



**VAUXHALL**  
British Brand since 1903



# CONTENTS

---

## RANGE HIGHLIGHTS

Explore the VIVA range and find your perfect model.

## MODELS

Find all the information you need about your chosen model.

## PRICES

Find on-the-road recommended retail prices.

## FEATURES/OPTIONS

Tailor your chosen model to suit your needs with everything from a satellite navigation to rear-view camera and parking sensors.

## EXTERIOR COLOURS

Add some sparkle to your car with a metallic paint.

## WHEELS AND TYRES

Why not upgrade to a set of distinctive alloy wheels to give your car more presence.

## PERFORMANCE, FUEL ECONOMY AND EMISSIONS

Know how many miles you will get around town, the CO<sub>2</sub> figures and the 0–60 time.

## DIMENSIONS

Ensure your car will fit in the garage and know how much luggage you can take for a long weekend away.

## SPECIFICATIONS

Towing weights, engine details and other useful details you may need to know.

## ACCESSORIES

Add some practical touches to your car with our range of quality accessories.

## COMPANY CAR INFORMATION

Benefit in Kind company car tax, 3 day test drives and P11D.

## FURTHER INFORMATION

Insurance groups, vehicle excise duty, our range of additional products and much more.



# VIVA RANGE HIGHLIGHTS



## SE OTR from £10,175

### Standard features include:

#### Safety:

- Anti-lock Braking System (ABS)
- Electronic Stability Programme (ESP)
- Six airbags
- ISOFIX child seat restraint system for outer rear seats
- Perimeter alarm system

#### Interior features:

- Power-assisted steering with City Mode
- Electrically operated front windows
- Electrically adjustable/heated door mirrors
- Multi-function trip computer
- Remote control central deadlocking
- Stereo radio and USB audio connection
- Bluetooth® connectivity
- Steering wheel mounted audio controls
- Tiltable steering column
- Driver's seat height adjuster
- 60/40 split-folding rear seat back and seat base

#### Exterior features:

- Daytime running lights
- Front fog lights
- Emergency tyre inflation kit
- 15-inch structure wheels

#### SE Nav models additionally feature:

- Air conditioning
- Navi 4.0 IntelliLink satellite navigation system

## SL OTR from £11,075

### Features over SE:

#### Interior features:

- Electronic climate control
- Cruise control
- Two-tone grey facia
- Leather-covered steering wheel

#### Exterior features:

- Dark-tinted rear windows
- 15-inch alloy wheels

## ROCKS OTR from £11,940

### Features over SE:

#### Interior features:

- Air conditioning

#### Exterior features:

- Raised ground clearance
- Anthracite rear bumper, side sills and wheel arch mouldings
- Chrome-effect side sills and front and rear bumper inserts
- Silver-effect roof rails
- 15-inch bi-colour alloy wheels

## KEY OPTIONS Total inc. VAT

	<b>Looking good:</b>	
	16-inch alloy wheels	£310
	Brilliant paint	£285
	Metallic / pearlescent paint	£565
	<b>Winter warming:</b>	
	Winter Pack	from £160
	<b>Driving assistance:</b>	
	Lane departure warning	£160
	Satellite Navigation systems	£935
	<b>Practicality:</b>	
	Electrically operated glass sunroof	£510
	Rear parking distance sensors	£285
	<b>Infotainment:</b>	
	Multimedia infotainment system	£435



# SE



## SE ON-THE-ROAD PRICES

		OTR RRP	CO <sub>2</sub> (g/km)
Petrol	1.0i (73PS)	<b>£10,175</b>	117
	1.0i (73PS) (a/c)	<b>£10,670</b>	117

## SE NAV ON-THE-ROAD PRICES

Petrol	1.0i (73PS) (a/c)	<b>£11,605</b>	117
--------	-------------------	----------------	-----

**Please note:** On-the-road recommended retail prices (RRP) include VAT at 20%, number plates and delivery to Retailer of £700.00 (inc. £116.67 VAT), 12 months' Vehicle Excise Duty and new vehicle first registration fee of £55.00. Excludes fuel and insurance.

a/c = Air conditioning.

## FEATURES

### Infotainment:

- R300 BT radio – for use with media players, USB memory sticks and mobile phones
- AM/FM stereo radio
- USB connection with iPod control
- Bluetooth® music streaming
- Bluetooth® mobile phone portal

### Interior convenience / styling:

- Speed-sensitive power-assisted steering with City Mode
- Electrically operated front windows
- Electrically adjustable/heated door mirrors
- Multi-function trip computer
- Remote control central deadlocking
- Steering wheel mounted audio controls
- Tiltable steering column
- Driver's seat height adjuster
- Height-adjustable front seat head restraints
- 60/40 split-folding rear seat back and seat base
- Removable luggage compartment cover

### Exterior features:

- Daytime running lights
- Front fog lights
- Emergency tyre inflation kit
- 15-inch structure wheels

### Safety:

- Anti-lock Braking System (ABS)
- Electronic Stability Programme (ESP) with traction control
- Driver's and front passenger's airbags
- Front seat side-impact airbags
- Curtain airbags
- Tyre pressure monitoring system
- ISOFIX child seat restraint system for outer rear seats
- Three inertia-reel lap and diagonal rear seatbelts
- Perimeter alarm system
- Electronic engine deadlock immobiliser

## SE NAV MODELS ADDITIONALLY FEATURE

### Infotainment:

- Navi 4.0 IntelliLink satellite navigation system

### Interior convenience / styling:

- Air conditioning



# SL



## SL ON-THE-ROAD PRICES

		OTR RRP	CO <sub>2</sub> (g/km)
Petrol	1.0i (73PS)	<b>£11,075</b>	117

**Please note:** On-the-road recommended retail prices (RRP) include VAT at 20%, number plates and delivery to Retailer of £700.00 (inc. £116.67 VAT), 12 months' Vehicle Excise Duty and new vehicle first registration fee of £55.00. Excludes fuel and insurance.

## FEATURES

### Infotainment:

- R300 BT radio – for use with media players, USB memory sticks and mobile phones
- AM/FM stereo radio
- USB connection with iPod control
- Bluetooth® music streaming
- Bluetooth® mobile phone portal

### Interior convenience / styling:

- Electronic climate control
- Cruise control
- Speed-sensitive power-assisted steering with City Mode
- Electrically operated front windows
- Electrically adjustable/heated door mirrors
- Multi-function trip computer
- Remote control central deadlocking
- Leather-covered steering wheel
- Steering wheel mounted audio controls
- Tiltable steering column
- Driver's seat height adjuster
- Height-adjustable front seat head restraints
- 60/40 split-folding rear seat back and seat base
- Two-tone grey facia
- Removable luggage compartment cover

### Exterior features:

- Daytime running lights
- Front fog lights with chrome-effect trim and cornering light function
- Dark-tinted rear windows
- Emergency tyre inflation kit
- 15-inch alloy wheels

### Safety:

- Anti-lock Braking System (ABS)
- Electronic Stability Programme (ESP) with traction control
- Driver's and front passenger's airbags
- Front seat side-impact airbags
- Curtain airbags
- Tyre pressure monitoring system
- ISOFIX child seat restraint system for outer rear seats
- Three inertia-reel lap and diagonal rear seatbelts
- Perimeter alarm system
- Electronic engine deadlock immobiliser



# ROCKS



## ROCKS ON-THE-ROAD PRICES

		OTR RRP	CO <sub>2</sub> (g/km)
Petrol	1.0i (73PS)	<b>£11,940</b>	118

**Please note:** On-the-road recommended retail prices (RRP) include VAT at 20%, number plates and delivery to Retailer of £700.00 (inc. £116.67 VAT), 12 months' Vehicle Excise Duty and new vehicle first registration fee of £55.00. Excludes fuel and insurance.

## FEATURES

### Infotainment:

- R300 BT radio – for use with media players, USB memory sticks and mobile phones
- AM/FM stereo radio
- USB connection with iPod control
- Bluetooth® music streaming
- Bluetooth® mobile phone portal

### Interior convenience / styling:

- Air conditioning
- Cruise control
- Speed-sensitive power-assisted steering with City Mode
- Electrically operated front windows
- Electrically adjustable/heated door mirrors
- Multi-function trip computer
- Remote control central deadlocking
- Steering wheel mounted audio controls
- Tiltable steering column
- Driver's seat height adjuster
- Height-adjustable front seat head restraints
- 60/40 split-folding rear seat back and seat base
- Removable luggage compartment cover

### Exterior features:

- Daytime running lights
- Front fog lights
- Raised ground clearance
- Anthracite rear bumper, side sills and wheel arch mouldings
- Chrome-effect side sills and front and rear bumper inserts
- Silver-effect roof rails
- Emergency tyre inflation kit
- 15-inch bi-colour alloy wheels

### Safety:

- Anti-lock Braking System (ABS)
- Electronic Stability Programme (ESP) with traction control
- Driver's and front passenger's airbags
- Front seat side-impact airbags
- Curtain airbags
- Tyre pressure monitoring system
- ISOFIX child seat restraint system for outer rear seats
- Three inertia-reel lap and diagonal rear seatbelts
- Perimeter alarm system
- Electronic engine deadlock immobiliser



# VIVA PRICES

	Fuel Type	Price (£)	VAT (£)	Total (£)	On-the-road RRP (£)	CO <sub>2</sub> (g/km)
<b>SE</b>						
1.0i (73PS)	Petrol	7,712.50	1,542.50	9,255.00	<b>10,175.00</b>	117
1.0i (73PS) (a/c)	Petrol	8,125.00	1,625.00	9,750.00	<b>10,670.00</b>	117
<b>SE NAV</b>						
1.0i (73PS) (a/c)	Petrol	8,904.17	1,780.83	10,685.00	<b>11,605.00</b>	117
<b>SL</b>						
1.0i (73PS)	Petrol	8,462.50	1,692.50	10,155.00	<b>11,075.00</b>	117
<b>ROCKS</b>						
1.0i (73PS)	Petrol	9,183.33	1,836.67	11,020.00	<b>11,940.00</b>	118

a/c = Air conditioning.

Please note: On-the-road recommended retail prices (RRP) include number plates and delivery to retailer of £700.00 (inc. £116.67 VAT), 12 months' Vehicle Excise Duty and new vehicle first registration fee of £55.00. Excludes fuel and insurance.



# FEATURES/OPTIONS

## SAFETY

	SE	SE Nav	SL	ROCKS	Price (£) exc. VAT	Price (£) inc. VAT
<b>Driver / passenger airbags</b> <ul style="list-style-type: none"> <li>• Driver's airbag • Front passenger's airbag • Two front seat side-impact airbags</li> <li>• Full-size curtain airbags for driver and front and outer rear seat passengers</li> </ul>	●	●	●	●		
<b>Seating</b> <ul style="list-style-type: none"> <li>• Height-adjustable front and rear seat head restraints</li> <li>• Anti-submarining ramps in all seats – Prevents occupants sliding underneath the lap belt during a collision.</li> </ul>	●	●	●	●		
<b>Seatbelts</b> <ul style="list-style-type: none"> <li>• Front inertia-reel lap and diagonal seatbelts • Three inertia-reel lap and diagonal rear seatbelts</li> <li>• Front and rear seatbelt pretensioner system – Pretensioners tighten the seatbelt in the event of an accident limiting forward movement. • Front and rear 'seatbelt unfastened' audible warning and warning light</li> </ul>	●	●	●	●		
<b>Child safety</b> <ul style="list-style-type: none"> <li>• Deactivation switch for front passenger seat's front airbag – Permits the safe use of a child seat in the front passenger seat.</li> <li>• ISOFIX child seat mountings incorporating top tether anchor points located on outer rear seats (does not include child seat) – Allows ISOFIX child safety seats to be securely fixed into the car. The ISOFIX mounting system reduces forward movement in an accident and makes the child seat easier to install.</li> <li>• Child-proof locks on rear doors</li> </ul>	●	●	●	●		
<b>Pedestrian safety</b> <ul style="list-style-type: none"> <li>• Bonnet/headlight/wiper structure – Designed to reduce pedestrian head and upper body injuries.</li> <li>• Upper and lower bumper design – Reduces upper and lower leg injuries.</li> </ul>	●	●	●	●		





# FEATURES/OPTIONS

## SAFETY CONTINUED

	SE	SE Nav	SL	ROCKS	Price (£) exc. VAT	Price (£) inc. VAT
<p><b>Stability</b></p> <ul style="list-style-type: none"> <li>• Electronic Stability Programme (ESP) – Works in conjunction with the vehicle's electronic braking and engine systems to keep the car stable in many different situations. ESP monitors many different inputs to determine when the car starts to lose traction, it can then immediately respond by varying the brake pressure between up to three wheels and adjust the engine output to help correct the loss of traction and improve stability.</li> </ul> <p><b>Additional ESP features:</b></p> <ul style="list-style-type: none"> <li>• Traction control • Cornering brake control • Straight line stability control • Rollover mitigation</li> <li>• Drag torque control – Maintain stability on slippery roads when lifting off the accelerator or changing gear.</li> </ul>	●	●	●	●		
<p><b>Braking</b></p> <ul style="list-style-type: none"> <li>• Anti-lock Braking System (ABS) – Prevents the vehicle's wheels from locking up under heavy braking by momentarily reducing brake pressure at the appropriate wheel, ensuring that you can maintain control of the steering.</li> </ul> <p><b>Additional braking features:</b></p> <p>The same electronic systems used in the ABS and ESP also deliver exceptional braking performance.</p> <ul style="list-style-type: none"> <li>• Emergency brake assist – When emergency braking is detected the vehicle automatically applies the maximum possible braking assistance.</li> <li>• Fading brake support – Compensates for the effects of brake fade.</li> <li>• Electronic brakeforce distribution – Automatically apportions the optimum braking force to each wheel.</li> <li>• Adaptive brake lights – Automatically warns other road users of heavy braking.</li> <li>• Hill start assist – Briefly maintains rear brake pressure to stop the vehicle rolling back on an incline.</li> </ul>	●	●	●	●		
<p><b>Tyre pressure</b></p> <ul style="list-style-type: none"> <li>• Tyre pressure monitoring system</li> </ul>	●	●	●	●		



# FEATURES/OPTIONS

## SECURITY

	SE	SE Nav	SL	ROCKS	Price (£) exc. VAT	Price (£) inc. VAT
<b>Standard security features</b> <ul style="list-style-type: none"> <li>• Electronically protected audio equipment</li> <li>• Engine deadlock immobiliser</li> <li>• Visible Vehicle Identification Number (VIN)</li> <li>• Locking fuel filler flap with interior release</li> <li>• Locking wheel bolts for alloy wheels (SL only)</li> </ul>	●	●	●	●		
<b>Perimeter alarm system</b> <ul style="list-style-type: none"> <li>• Bonnet, doors, tailgate</li> </ul>	●	●	●	●		
<b>Remote control central locking</b> <ul style="list-style-type: none"> <li>• Doors, tailgate</li> <li>• Interior activation switch on driver's door</li> <li>• Folding key</li> </ul>	●	●	●	●		



# FEATURES/OPTIONS

## DRIVER ASSISTANCE

	SE	SE Nav	SL	ROCKS	Price (£) exc. VAT	Price (£) inc. VAT
<p><b>Power-assisted steering</b></p> <ul style="list-style-type: none"> <li>Electrically assisted steering</li> <li>Switchable 'City Mode' additional steering assistance                             <ul style="list-style-type: none"> <li>City Mode reduces steering effort for easy manoeuvring in city traffic and when parking.</li> </ul> </li> </ul>	●	●	●	●		
<p><b>Cruise control with speed limiter</b></p> <ul style="list-style-type: none"> <li>Cruise control – Set/keep a constant cruising speed without using the accelerator, ideal comfort for longer distance driving.</li> <li>Speed limiter function – Can be set to ensure that you do not exceed the speed limit.</li> <li>Steering wheel mounted controls</li> </ul>			●	●		
<p><b>Lane departure warning</b></p> <p>The lane departure warning system recognises when the car moves outside of lane markings at speeds above 35mph. A warning is sounded if the driver has not signalled</p> <ul style="list-style-type: none"> <li>Warning light</li> <li>Audible alert</li> <li>Facia on/off switch</li> </ul>	○	○	○	○	133.33	160.00
<p><b>Shift-up/down indication light</b></p> <p>Indicates when to change gear for optimum fuel economy.</p>	●	●	●	●		
<p><b>Hill start assist</b></p> <p>Briefly maintains rear brake pressure to stop the vehicle rolling back on an incline.</p>	●	●	●	●		
<p><b>Rear parking distance sensors</b></p>	○	○	○	○	237.50	285.00



# FEATURES/OPTIONS

## CONVENIENCE

	SE	SE Nav	SL	ROCKS	Price (£) exc. VAT	Price (£) inc. VAT
<b>Electrically operated front windows</b>	●	●	●	●		
<b>Twin electrically adjustable/heated door mirrors</b> • Wide-angle mirror on driver's side • Automatic heater cut-off • Manual folding	●	●	●	●		
<b>Electrically operated glass sunroof (not available in conjunction with optional Navi 4.0 IntelliLink system)</b> • Tilt and slide • Interior blind • Front passenger's tiltable assist handle	○		○		425.00	510.00



# FEATURES/OPTIONS

## DRIVER INFORMATION

	SE	SE Nav	SL	ROCKS	Price (£) exc. VAT	Price (£) inc. VAT
<b>Instrumentation</b> <ul style="list-style-type: none"> <li>• Speedometer • Rev counter • Digital fuel gauge with low fuel level warning light</li> <li>• Digital water temperature gauge with warning light</li> </ul>	●	●	●	●		
<b>Driver information display</b> <ul style="list-style-type: none"> <li>• Monochrome display • Displays trip computer data • Total mileage • Service-due indicator</li> <li>• Oil life • Tyre pressure monitoring system • Centrally located in instrument cluster</li> </ul>	●	●	●	●		
<b>Multi-function trip computer</b> <ul style="list-style-type: none"> <li>• Trip mileage • Vehicle range based on remaining fuel • Average speed</li> <li>• Average fuel economy • Instantaneous fuel economy • Driving time</li> </ul>	●	●	●	●		
<b>Multi-function central display (format dependent on infotainment unit)</b> <ul style="list-style-type: none"> <li>• Audio information • Digital clock with automatic RDS time adjustment • Outside air temperature</li> </ul>	●	●	●	●		



# FEATURES/OPTIONS

## INTERIOR STYLING

	SE	SE Nav	SL	ROCKS	Price (£) exc. VAT	Price (£) inc. VAT
<p><b>SE interior décor</b></p> <p><b>Steering wheel:</b></p> <ul style="list-style-type: none"> <li>• Three-spoke design • Chrome-effect trim insert</li> </ul> <p><b>Facia and door trim:</b></p> <ul style="list-style-type: none"> <li>• Jet black facia • Jet black door panels • Black interior door handles</li> </ul> <p><b>Seat trim:</b></p> <ul style="list-style-type: none"> <li>• Bada Jet black fabric seat trim inserts • Plain black fabric side bolsters and surrounds</li> </ul>	●	●				
<p><b>SL interior décor</b></p> <p><b>Steering wheel:</b></p> <ul style="list-style-type: none"> <li>• Three-spoke design • Leather-covered with accent stitching • Chrome-effect trim insert</li> </ul> <p><b>Facia and door trim:</b></p> <ul style="list-style-type: none"> <li>• Two-tone dark grey/light grey facia • Two-tone dark grey/light grey door panels</li> <li>• Chrome-effect interior door handles</li> </ul> <p><b>Seat trim:</b></p> <ul style="list-style-type: none"> <li>• Baram Jet black/Mid Dark Cinder Grey fabric seat trim inserts</li> <li>• Plain black premium leather effect side bolsters and surrounds</li> </ul>			●			
<p><b>Rocks interior décor</b></p> <p><b>Steering wheel:</b></p> <ul style="list-style-type: none"> <li>• Three-spoke design • Chrome-effect trim insert</li> </ul> <p><b>Facia and door trim:</b></p> <ul style="list-style-type: none"> <li>• Jet black facia • Jet black door panels • Chrome-effect interior door handles</li> </ul> <p><b>Seat trim:</b></p> <ul style="list-style-type: none"> <li>• Bada Jet black fabric seat trim inserts • Plain black fabric side bolsters and surrounds</li> </ul>				●		
<p><b>Additional décor features</b></p> <ul style="list-style-type: none"> <li>• Black gloss surround to outer facia air vents</li> </ul>	●	●	●	●		
<ul style="list-style-type: none"> <li>• Chrome-effect inserts to outer facia vents</li> </ul>			●	●		
<ul style="list-style-type: none"> <li>• Black gloss radio surround – Fitted in conjunction with optional Multimedia system or Navi 4.0 IntelliLink. Not available separately.</li> </ul>	○	●	●	○		
<ul style="list-style-type: none"> <li>• Black gloss instrument cluster and gear lever surround</li> </ul>	●	●		●		
<ul style="list-style-type: none"> <li>• Chrome-effect instrument cluster and gear lever surround</li> </ul>			●			
<ul style="list-style-type: none"> <li>• Chrome-effect door sill covers</li> </ul>				●		

● = Standard equipment. ○ = Optional at extra cost.



# FEATURES/OPTIONS

## INFOTAINMENT

	SE	SE Nav	SL	ROCKS	Price (£) exc. VAT	Price (£) inc. VAT
<p><b>R300 BT radio – for use with media players, USB memory sticks and mobile phones</b></p> <p><b>Onboard features:</b></p> <ul style="list-style-type: none"> <li>• AM/FM stereo radio with 24 station presets • RDS with Traffic Programme • 25 watts per channel output</li> </ul> <p><b>Media connections:</b></p> <ul style="list-style-type: none"> <li>• USB connection with iPod control</li> <li>• Bluetooth® music streaming – Advanced Audio Distribution Profile (A2DP).</li> </ul> <p><b>Mobile phone portal:</b></p> <ul style="list-style-type: none"> <li>• Bluetooth® connectivity • Handsfree calls via steering wheel controls • Vehicle microphone</li> <li>• Phone book access – Features dependent on mobile phone.</li> </ul>	●		●	●		
<p><b>Multimedia touchscreen infotainment system – for use with media players, USB memory sticks, mobile phones and smartphone apps</b></p> <p><b>Onboard features:</b></p> <ul style="list-style-type: none"> <li>• 7-inch colour touchscreen • DAB digital radio/AM/FM stereo radio with 36 station presets</li> <li>• RDS with Traffic Programme</li> </ul> <p><b>Media connections:</b></p> <ul style="list-style-type: none"> <li>• USB connection with iPod control</li> <li>• Bluetooth® music streaming – Advanced Audio Distribution Profile (A2DP).</li> </ul> <p><b>Mobile phone portal:</b></p> <ul style="list-style-type: none"> <li>• Bluetooth® connectivity • Handsfree calls via steering wheel controls • Vehicle microphone</li> <li>• Phone book access – The majority of the phone's functions – contacts/last calls/missed calls etc. – are mirrored on display and are easily navigated using the touchscreen (features dependent on mobile phone).</li> </ul> <p><b>Phone projection:</b></p> <ul style="list-style-type: none"> <li>• Android Auto™</li> <li>• Apple CarPlay™ incorporating Siri Eyes Free – Siri Eyes Free and Android Auto enable voice control of many functions of your smartphone:</li> <li>• Make/receive calls • Return missed calls • Listen to voicemail • Send/read out/reply to text messages</li> <li>• Access music library</li> </ul>	○		○	○	362.50	<b>435.00</b>



# FEATURES/OPTIONS

## INFOTAINMENT CONTINUED







	SE	SE Nav	SL	ROCKS	Price (£) exc. VAT	Price (£) inc. VAT
<p><b>Navi 4.0 IntelliLink touchscreen navigation and infotainment system – for use with media players, USB memory sticks, mobile phones and smartphone apps</b></p> <p><b>Onboard features:</b></p> <ul style="list-style-type: none"> <li>• 7-inch colour touchscreen • DAB digital radio/AM/FM stereo radio with 36 station presets</li> <li>• RDS with Traffic Programme</li> </ul> <p><b>Navigation features:</b></p> <ul style="list-style-type: none"> <li>• Satellite navigation system • 2D street level mapping • European coverage</li> <li>• Structured or one-box destination entry • Points-of-interest search • Eco routing • Map updates via USB</li> </ul> <p><b>Media connections:</b></p> <ul style="list-style-type: none"> <li>• USB connection with iPod control</li> <li>• Bluetooth® music streaming – Advanced Audio Distribution Profile (A2DP).</li> </ul> <p><b>Mobile phone portal:</b></p> <ul style="list-style-type: none"> <li>• Bluetooth® connectivity • Handsfree calls via steering wheel controls • Vehicle microphone</li> <li>• Phone book access – The majority of the phone's functions – contacts/last calls/missed calls etc. – are mirrored on display and are easily navigated using the touchscreen (features dependent on mobile phone).</li> </ul> <p><b>Phone projection:</b></p> <ul style="list-style-type: none"> <li>• Android Auto™</li> <li>• Apple CarPlay™ incorporating Siri Eyes Free – Siri Eyes Free and Android Auto enable voice control of many functions of your smartphone:</li> <li>• Make/receive calls • Return missed calls • Listen to voicemail • Send/read out/reply to text messages</li> <li>• Access music library</li> </ul> <p><b>Gallery:</b></p> <p>Only available when vehicle is stationary</p> <ul style="list-style-type: none"> <li>• Photo gallery with slide show feature • Video playback with soundtrack played through car speakers</li> </ul>	○	●	○	○	779.17	935.00
<b>Four speakers</b>	●	●	●	●		
<b>Steering wheel controls</b>	●	●	●	●		
• Audio controls • Bluetooth® mobile phone controls						





# FEATURES/OPTIONS

## ONSTAR

						SE	SE Nav	SL	ROCKS	Price (£) exc. VAT	Price (£) inc. VAT
											
<b>Automatic Crash Response</b>	<b>Wi-Fi Hotspot</b>	<b>Smartphone App</b>	<b>Stolen Vehicle Assistance</b>	<b>Vehicle Diagnostics</b>	<b>Destination Download</b>						
<p><b>OnStar – Your personal on board assistant*</b></p> <p>Many car brands talk about innovation as soon as they improve their cup holders but this innovative system, now available on selected models**, is revolutionary: 24/7, 365 days a year, OnStar puts you in touch with a trained advisor, not a machine. With OnStar you have access to a host of innovations, from Vehicle Diagnostics and Smartphone Function to a fully integrated 4G Wi-Fi Hotspot<sup>†</sup>. In the event of an accident, OnStar even automatically calls for help, for an incomparable feeling of safety. OnStar – Your personal connectivity and service assistant.</p>										345.83	415.00
						O	O	O	O		
											

\*Includes 12 months of OnStar services from date of first registration and a 3 month/3 GB Wi-Fi free trial period (whichever comes first) effective from the date the customer accepts the nominated network operator Wi-Fi Ts&Cs. Destination download feature only operates on models fitted with Navi 4.0 IntelliLink satellite navigation system.

\*\*The OnStar Services require activation and are subject to mobile network coverage and availability. Wi-Fi Hotspot service requires account with nominated network operator.

<sup>†</sup>4G is subject to mobile network coverage and availability. Charges apply after the free trial period. The OnStar subscription packages could be different from the services included in the free trial package. Check [www.vauxhall.co.uk/onstar](http://www.vauxhall.co.uk/onstar) for terms and conditions, details of availability, coverage and charges.

All OnStar services and Wi-Fi services will cease to be available on 31 December 2020. No trial or paid subscriptions or services, including emergency response services, will be available after that date.

O = Optional at extra cost.



# FEATURES/OPTIONS

## INTERIOR COMFORT

	SE	SE Nav	SL	ROCKS	Price (£) exc. VAT	Price (£) inc. VAT
<p><b>Driver comfort</b></p> <p><b>Driver's seat (six-way adjustable):</b></p> <ul style="list-style-type: none"> <li>• Reach (fore/aft) • Backrest recline (upright/incline) • Driver's seat height adjuster • Head restraint (up/down)</li> </ul> <p><b>Steering adjustment:</b></p> <ul style="list-style-type: none"> <li>• Steering column adjustable for rake</li> </ul>	●	●	●	●		
<p><b>Passenger comfort</b></p> <p><b>Front passenger's seat (six-way adjustable):</b></p> <ul style="list-style-type: none"> <li>• Reach (fore/aft) • Backrest recline (upright/incline) • Head restraint (up/down)</li> <li>• Deactivation switch for front passenger seat's front airbag – Permits the safe use of a child seat in the front passenger seat.</li> </ul> <p><b>Rear seat:</b></p> <ul style="list-style-type: none"> <li>• Three person layout • 60/40 split-folding rear seat back and seat base • Three removable head restraints</li> <li>• ISOFIX child seat mountings incorporating top tether anchor points located on outer rear seats (does not include child seat) – Allows ISOFIX child safety seats to be securely fixed into the car. The ISOFIX mounting system reduces forward movement in an accident and makes the child seat easier to install.</li> <li>• Child-proof locks on rear doors</li> </ul>	●	●	●	●		



# FEATURES/OPTIONS

## HEATING AND VENTILATION

	SE	SE Nav	SL	ROCKS	Price (£) exc. VAT	Price (£) inc. VAT
<b>Air blend heater</b> • Four-speed fan • Illuminated controls • Interior pollen filter	●					
<b>Air conditioning</b> • Air recirculation facility • Cabin particulate filter – Removes dust, airborne particles and pollen. • Four-speed fan • Illuminated controls	▲	●		●		
<b>Electronic climate control</b> • Advanced climate control including air conditioning • Advanced predictive logic control system using sun and humidity sensors • Partial air recirculation – Faster warm up/cool down. • Cabin particulate filter – Removes dust, airborne particles and pollen. • Automatic air direction and fan speed with manual override • LCD temperature display • Illuminated controls			●			
<b>Additional features</b> • Four adjustable facia vents • Windscreen demist vents • Side window demist vents	●	●	●	●		
<b>SE Winter Pack</b> • Electrically heated front seats • Electrically heated leather-covered steering wheel	○	○			191.67	230.00
<b>SL/Rocks Winter Pack</b> • Electrically heated front seats • Electrically heated leather-covered steering wheel			○	○	133.33	160.00



# FEATURES/OPTIONS

## INTERIOR CONVENIENCE, STORAGE AND LIGHTING

	SE	SE Nav	SL	ROCKS	Price (£) exc. VAT	Price (£) inc. VAT
<b>Convenience features</b>						
• Front 12-volt electrical accessory socket • Twin sunvisors • Dipping rear-view mirror • Two roof-mounted rear coat hooks	●	●	●	●		
• Front passenger's vanity mirror with flip-up cover and ticket holder	●	●	●	●		
<b>Interior storage</b>						
• Glovebox with lid • Open storage above glovebox • Front door pockets • Two drinks holders in front centre console • Single drinks holder in rear passenger centre console	●	●	●	●		
<b>Load area</b>						
• Luggage compartment cover • Fully carpeted load area • Interior tailgate handle • Twin gas-assisted tailgate struts • Touch-sensitive exterior tailgate release	●	●	●	●		
• Illuminated load area			●			
<b>Interior lighting</b>						
• Instrument panel and facia light dimmer	●	●	●	●		
• Front courtesy light	●	●	●	●		



# FEATURES/OPTIONS

## EXTERIOR CONVENIENCE AND LIGHTING

	SE	SE Nav	SL	ROCKS	Price (£) exc. VAT	Price (£) inc. VAT
<b>Convenience features</b>						
• Two-speed windscreen wipers with variable intermittent wipe • Heated rear window • Intermittent rear window wash/wipe • Manually foldable door mirrors	●	●	●	●		
<b>Exterior lighting</b>						
• Daytime running lights • Halogen headlights • Lights-on audible warning • Electric headlight beam levelling • High-level centre brake light • Rear fog light	●	●	●	●		
• Front fog lights				●		
• Front fog lights with cornering light function	●	●				
• Front fog lights with chrome-effect trim and cornering light function			●			





# FEATURES/OPTIONS

## EXTERIOR STYLING

	SE	SE Nav	SL	ROCKS	Price (£) exc. VAT	Price (£) inc. VAT
<b>SE body styling</b> • Chrome-effect front grille bar • Body-colour door handles • Body-colour door mirrors • Body-colour rear roof spoiler	●	●				
<b>SL body styling</b> • Chrome-effect front grille bar • Chrome-effect front fog light accents • Body-colour door handles • Body-colour door mirrors • Body-colour rear roof spoiler • Black foil on B-pillars			●			
<b>Rocks body styling</b> • Chrome-effect front grille bar • Body-colour door handles • Body-colour door mirrors • Body-colour rear roof spoiler • Raised ground clearance • Anthracite bumpers with chrome-effect inserts • Anthracite wheel arches • Anthracite side sills with chrome-effect inserts				●		
• Roof rails – silver-effect				●		
<b>Windows</b> • Tinted windows	●	●	●	●		
• Dark-tinted rear windows			●			



# EXTERIOR COLOURS



			SE	SE Nav	SL	ROCKS	Price (£) exc. VAT	Price (£) inc. VAT
Two-coat		Mushroom metallic	●	●	●	●		
Brilliant		Summit White	○	○	○	○	237.50	285.00
		Lava Red						

The colours reproduced may vary slightly from the actual paint colour. As a result they should be used as a guide only. Your Vauxhall Retailer has a comprehensive display of our paint samples.

● = Standard equipment. ○ = Optional at extra cost.

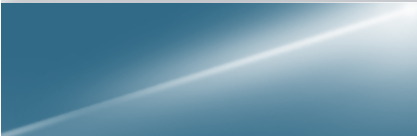
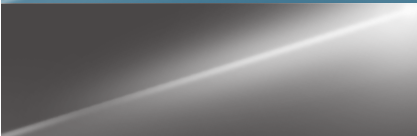

# EXTERIOR COLOURS

			SE	SE Nav	SL	ROCKS	Price (£) exc. VAT	Price (£) inc. VAT
Two-coat		Sovereign Silver metallic						
		Petrol Blue metallic						
		Quantum Grey metallic	○	○	○	○	470.83	565.00
		Mineral Black metallic						
Premium		Cherry Red	○	○	○	○	545.83	655.00

The colours reproduced may vary slightly from the actual paint colour. As a result they should be used as a guide only. Your Vauxhall Retailer has a comprehensive display of our paint samples.

○ = Optional at extra cost.





# WHEELS AND TYRES

	SE	SE Nav	SL	ROCKS	Price (£) exc. VAT	Price (£) inc. VAT
 <p><b>15-inch structure wheels</b></p> <ul style="list-style-type: none"> <li>• 185/55 R 15 tyres</li> <li>• Emergency tyre inflation kit (in lieu of spare wheel)</li> </ul>	●	●				
 <p><b>15-inch alloy wheels</b></p> <ul style="list-style-type: none"> <li>• 185/55 R 15 tyres</li> <li>• Emergency tyre inflation kit (in lieu of spare wheel)</li> </ul>			●			
 <p><b>15-inch bi-colour alloy wheels</b></p> <ul style="list-style-type: none"> <li>• 185/55 R 15 tyres</li> <li>• Emergency tyre inflation kit (in lieu of spare wheel)</li> </ul>				●		
 <p><b>16-inch alloy wheels</b></p> <ul style="list-style-type: none"> <li>• 195/45 R 16 tyres</li> <li>• Emergency tyre inflation kit (in lieu of spare wheel)</li> </ul>			○		258.33	310.00
<b>Full-size steel spare wheel (in lieu of emergency tyre inflation kit)</b>	○	○	○	○	91.67	110.00



# PERFORMANCE, FUEL ECONOMY AND EMISSIONS

	Performance (manufacturer's figures)				Fuel economy mpg (litres/100km) <sup>#</sup>			CO <sub>2</sub> emissions g/km <sup>#</sup>	Vehicle Excise Duty*		Benefit in kind company car taxation rates - 2018/19 tax year
	Fuel Type	Wheel size (inches)	Maximum speed (mph)	Acceleration 0-60mph (sec)	Urban driving	Extra-urban driving	Combined figure		First year rate	Standard rate	
<b>VIVA</b>											
<b>1.0i (73PS)</b>	Petrol	15/16	106	13.1	45.6 (6.2)	62.8 (4.5)	55.4 (5.1)	117	£165	£140	24%
<b>1.0i (73PS) ROCKS</b>	Petrol	15	106	13.1	45.6 (6.2)	62.8 (4.5)	55.4 (5.1)	118	£165	£140	24%

\*Correct at time of publication.

<sup>#</sup>Fuel consumption data and CO<sub>2</sub> emission data are determined using the Worldwide harmonized Light vehicles Test Procedure (WLTP), and the relevant values are translated back to allow the comparability into NEDC, according to regulations R (EC) No. 715/2007, R (EU) No. 2017/1153 and R (EU) No. 2017/1151. The values do not take into account in particular use and driving conditions, equipment or options and may vary depending on the format of tyres. For more information on official fuel consumption and CO<sub>2</sub> emission values, please read the guidelines at <http://carfueldata.dft.gov.uk/> and for more information on WLTP please see [www.vauxhall.co.uk/wltp](http://www.vauxhall.co.uk/wltp)



# DIMENSIONS

## VIVA

### Loadspace Dimensions millimetres (inches)

Load floor length (rear seats folded)	1107 (43.6)
Load floor length (behind rear seats)	484 (19.1)
Load area width	960 (37.8)
Load area height	850 (33.5)
Tailgate aperture width (maximum)	955 (37.6)
Tailgate aperture height	608 (23.9)

### Luggage Capacities\* litres (cu.ft.)

Rear seat up**	206 (7.3)
Rear seat down†	1013 (35.8)

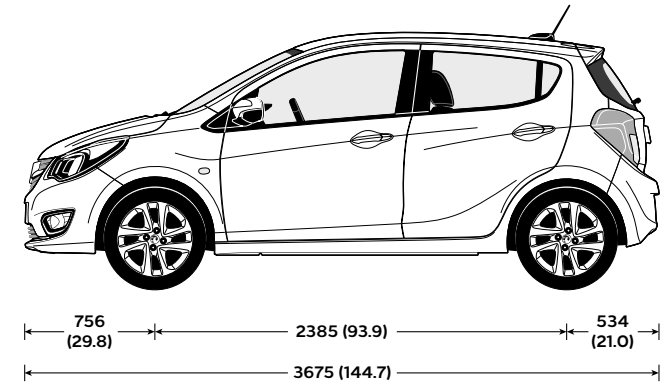
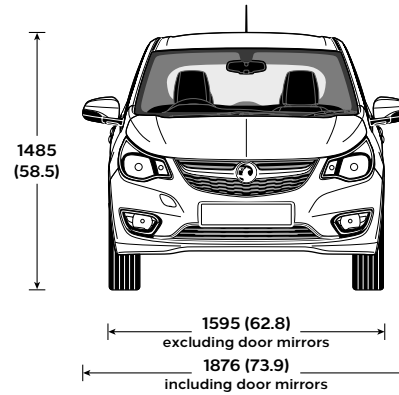

VIVA

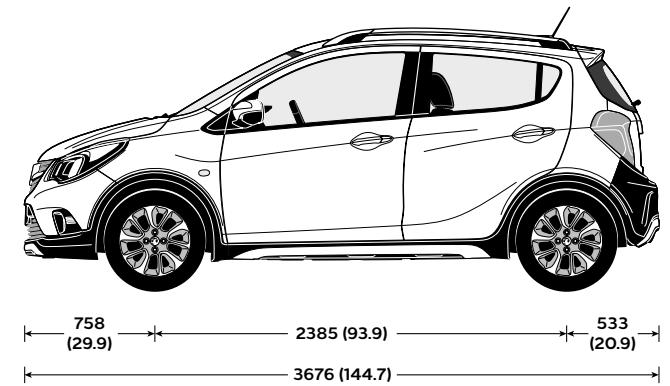
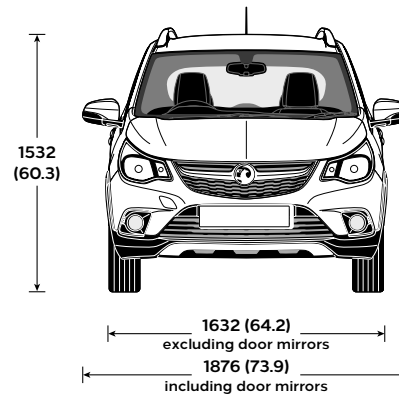

VIVA ROCKS

All measurements are in mm (inches) unless stated otherwise.

\*Measured using the ECIE method.

\*\*Under luggage compartment cover.

†Measured to roof.



# SPECIFICATIONS

## Transmission

- Front-wheel drive
- Five-speed manual gearbox

## Steering

- Speed-sensitive electric power-assisted system
- Switchable City Mode for additional assistance
- Energy-absorbing steering column
- Turning circle (kerb-to-kerb): 10.4m (34.1ft.)

## Suspension

Front: Independent. MacPherson struts with gas-pressure dampers and linear-rate coil springs. Anti-roll bar.

Rear: Torsion beam with gas-pressure dampers and linear-rate coil springs.

## Brakes

- Anti-lock Braking System (ABS) – Four-channel
- Electronic brakeforce distribution
- Electronic Stability Programme
- Switchable traction control
- Dual circuit, diagonally split, servo-assisted system
- Asbestos-free friction material
- Corrosion-protected brake pipes

## All models

- Front ventilated discs: 236mm diameter
- Rear drums: 200mm diameter

## Body

- Aerodynamic drag co-efficient: Cd 0.331

## Fuel Tank Capacity

- 32 litres (7.0 gallons)

## Electrics

- Battery: 50Ah
- Alternator: 80A

## Weights kg

	Gross Vehicle Weight (GVW)
1.0i (73PS)	1353

Gross vehicle weight is the total permissible weight of the vehicle including passengers and their luggage. Rocks models are the only VIVA models approved for carrying a roof load. The roof load should not exceed 50kg including the weight of the roof rack/carrier.



# PETROL ENGINE

Engine	<b>1.0i (73PS)</b>
Capacity	999cc
Maximum power	73PS (54kW) @ 6500rpm
Maximum torque	95Nm (70 lb.ft.) @ 4500rpm
Configuration	3 cylinders, 4 valves per cylinder, double overhead camshafts
Fuel/induction system	Naturally aspirated with Variable Valve Timing. Multi-point sequential electronic fuel injection
Emission compliance	Euro 6d-TEMP (6.2)
Service interval	20,000 miles or 1 year (whichever occurs sooner)



# ACCESSORIES

CHILD SEATS <sup>1</sup>	Total (inc. VAT)	PRACTICAL	Total (inc. VAT)	STYLING	Total (inc. VAT)
BABY-SAFE <sup>2</sup> – 0–13kg/birth to 15 months	£135.00	Spare bulb kit	£39.00	B-Pillar appliqué – Black out foil kit	£42.00
– ISOFIX base	£234.00	Smoker Pack	£36.00	VX-Line stainless steel pedal covers	£63.00
DUO ISOFIX <sup>2</sup> – 9–18kg/9 months to 4 years with top tether kit	£358.00	Centre console organiser	£16.00	Interior trim kit	
KID <sup>2</sup> –15–36kg or 4 to 12 years	£162.00			– Piano Black (with radio R300/R300 BT)	£60.00
		<b>PROTECTION</b>		Door sill plates	£52.00
<b>SAFETY</b>		Velour floor mats – set of four	£62.00		
Privacy shades – rear side windows	£62.00	Carpet floor mats – set of four	£40.00	<b>WHEELS<sup>3</sup></b>	
Privacy shades – tailgate window	£62.00	Cargo liner	£55.00	15-inch 8-spoke alloy wheel	£667.00
Parking sensors		Load area storage box	£90.00	16-inch 4 double-spoke alloy wheel	£705.00
– four fully flush front bumper mounted sensors		Load area retaining net	£79.00		
– unpainted	£349.00	Splash Guards			
– painted	£349.00	– Front	£65.00		
– four fully flush rear bumper mounted sensors		– Rear	£65.00		
– unpainted	£349.00	Body side mouldings	£157.00		
– painted	£349.00				
Safety Pack – first aid kit, warning triangle, hi-visibility vest, Vauxhall bag	£36.00				
First aid kit	£15.00				
Warning triangle	£17.00				
Hi-visibility vest	£9.00				
Fire extinguisher – 2kg	£38.00				
Tyre sealant	£73.00				
Tyre inflation compressor	£247.00				
<b>FLEXCONNECT RANGE</b>					
FlexConnect bracket	£21.00				
FlexConnect hook	£31.00				
FlexConnect coat hanger	£33.00				
FlexConnect folding table	£74.00				
FlexConnect iPad Mini cradle	£105.00				
FlexConnect iPad (1-4) cradle	£113.00				
FlexConnect iPad Air cradle	£112.00				
FlexConnect Samsung Galaxy cradle	£102.00				

**Please note:** Prices shown are fully fitted and painted, where applicable and include VAT. Please check with your local Vauxhall Retailer for details. It is advisable to ensure your insurance policy is adequate to cover additional fitted accessories. Prices correct at time of publication.

<sup>1</sup>Restrictions apply to the use of child seats, please consult your Vauxhall Retailer or request a copy of the Child seats brochure. <sup>2</sup>Without transponder. <sup>3</sup>Fitting time is based on four wheels fitted and includes static wheel balancing. Different tyres and locking wheel nuts may be required. Price excludes new tyres and locking wheel nuts.



# COMPANY CAR DRIVER AND FLEET INFORMATION

## Company Car Driver Free 3 Day Test Drive

Our free\* 3 Day Test Drive programme is open to all Company Car Drivers which allows you to choose any model in the current Vauxhall line-up (exclusions apply). With full insurance cover provided, it gives you a meaningful length of time to make an informed decision about your next company car.

Click below to book your free\* test drive [www.vauxhall3dtd.co.uk](http://www.vauxhall3dtd.co.uk) or call **0330 587 8221\*\***

\*The free 3 Day Test Drive programme is open to Company Car Drivers and Fleet Decision Makers. Available for UK Mainland only. Terms and conditions apply. Full terms and conditions can be found at [vauxhallfleet.co.uk/testdrive/index/terms](http://vauxhallfleet.co.uk/testdrive/index/terms).

\*\*Telephone lines open Monday to Friday 9:00am to 5:00pm excluding Bank Holidays. Calls may be recorded or monitored for quality and/or training purposes.

## Fleet Toolbox

Discover the facts in our online Toolbox for both Company Car Drivers and Fleet Decision Makers. The Fleet Toolbox has a host of useful calculators, comparators, interactive listings and information.

Visit the Fleet Toolbox by going to [www.vauxhall-toolbox.co.uk](http://www.vauxhall-toolbox.co.uk)

## RoadTrip App

The Vauxhall RoadTrip App is a free app that calculates and logs your mileage expenses for any UK business trips and generates reports to help you complete your mileage claims.

Available for both iPhone and Android, visit [www.vauxhall-toolbox.co.uk](http://www.vauxhall-toolbox.co.uk) or visit the iPhone or Android stores and search for Vauxhall RoadTrip to download it to your smartphone or tablet.

## Benefit in kind company car taxation†

The car benefit charge will be the car's list price (including VAT, options and accessories fitted, delivery to Retailer and number plates, but excluding Vehicle Excise Duty and new vehicle first registration fee) multiplied by the percentage charge for the CO<sub>2</sub> emissions band in which the car falls (see table opposite). Multiply this figure by your personal income tax rate (20%†† for Basic Rate, 40%†† for Higher Rate) to calculate your annual benefit in kind tax liability.

### Example:

#### VIVA SE 1.0i (73PS) (CO<sub>2</sub> emissions 117g/km)

On-the-road RRP	£10,175.00
Deduct: Vehicle Excise Duty	(£165.00)
New vehicle first registration fee	(£55.00)
Effective list price	£9,955.00
Add: Optional two-coat metallic paint	£565.00
List price for tax purposes (P11D value)	£10,520.00
Car benefit charge 2018-19 tax year (24%)	£2,524.00
Benefit in kind tax liability (2018-19 tax year)	
Basic Rate (20%) tax payer	£504.80
Higher Rate (40%) tax payer	£1,009.60

†Please note this Price Guide provides taxation information as a guide only. Vauxhall does not provide taxation guidance. Drivers should always take professional advice on their own tax position. ††Excludes residents of Scotland.

### BIK FOR SCOTTISH RESIDENTS

Effective 6 April 2018 the Scottish Government have introduced their own BIK taxation structure. This only applies to Company Car Drivers that are Scottish taxpayers. HMRC will determine whether or not an individual is a Scottish taxpayer based on where their main place of residence is.

#### The BIK rates for Scotland are:

- Over £11,850-£13,850 Starter Rate 19%
- Over £13,850-£24,000 Basic Rate 20%
- Over £24,000-£43,430 Intermediate Rate 21%
- Over £43,430-£150,000 Higher Rate 41%
- Above £150,000 Top Rate 46%

## Benefit in kind company car taxation table

CO <sub>2</sub> emissions in grams per kilometre	Percentage of cars price to be taxed	
	Non-Diesel† 2018-19 tax year	Diesel## 2018-19 tax year
Up to 50	13	17
51-75	16	20
76-94	19	23
95-99	20	24
100-104	21	25
105-109	22	26
110-114	23	27
115-119	24	28
120-124	25	29
125-129	26	30
130-134	27	31
135-139	28	32
140-144	29	33
145-149	30	34
150-154	31	35
155-159	32	36
160-164	33	37
165-169	34	37
170-174	35	37
175-179	36	37
180 and above	37	37

†Also applies to diesel vehicles that meet the Real Driving Emissions Step 2 (RDE2). ††Applies to vehicles that do not meet the Real Driving Emissions Step 2 (RDE2).

To calculate your own personal liability a car tax calculator is available at:

<https://www.vauxhallfleet.co.uk/toolbox>

## Contact Vauxhall Fleet

Please contact one of our dedicated sales teams who will be happy to help with your particular enquiry.

### Company Car Drivers

Call: **0345 111 2020**

Email: [company-car@vauxhallinfo.co.uk](mailto:company-car@vauxhallinfo.co.uk)

Telephone lines are open

- Monday to Friday 8:00am-9:00pm

- Saturday and Sunday 9:00am-6:00pm

### Fleet Decision Makers

Depending on the size of your fleet of vehicles, we have a dedicated team to handle your enquiries.

The lines are open Monday to Friday excluding Bank Holidays.

### 1-24 vehicles

Call: **0845 076 2254** (8:30am-5:00pm)

Email: [b2bsales@vauxhall.co.uk](mailto:b2bsales@vauxhall.co.uk)

### 25+ vehicles

Call: **0330 587 8222** (8:30am-5:00pm)

Email: [vauxhallfleet@vauxhall.co.uk](mailto:vauxhallfleet@vauxhall.co.uk)

### Special Vehicles (Police, Fire and Ambulance)

Call: **01582 409999** (8:30am-5:00pm)

Email: [vauxhallspecialvehicles@vauxhall.co.uk](mailto:vauxhallspecialvehicles@vauxhall.co.uk)



# FURTHER INFORMATION

## On-the-road prices

To eliminate uncertainty about hidden costs when buying a new car, Vauxhall publishes on-the-road recommended retail prices (RRP) and these are shown in the pricing tables within this price guide. These prices include VAT, number plates and delivery to Retailer of £700.00 (including £116.67 VAT), 12 months' Government Vehicle Excise Duty (see opposite for details) and the DVLA new vehicle first registration fee of £55.00.\*

**Please note:** The on-the-road recommended retail price (RRP) does not include fuel supplied by the Retailer, motor insurance or any other goods or services supplied by agreement between the Retailer and the customer.

## Price protection

Order a new Vauxhall for build in the current model year (as confirmed by your Retailer) for delivery no more than three months in advance and the price you are quoted is the price you pay. This is irrespective of any subsequent price rises between placing your order and delivery of your new car, but you must take delivery as soon as the car is available. Vauxhall Motors Limited is not liable for price adjustments caused by Government changes in the rate of VAT (currently 20%), Vehicle Excise Duty, DVLA new vehicle first registration fee or by any other applicable legislation or regulations.

## Vauxhall Finance Leasing

Vauxhall Finance Leasing is a trading style of Vauxhall Finance plc. Working with the Vauxhall Retailer network we provide competitive car and van leasing solutions for business users and private individuals. We combine the support of a national contract with the convenience of a local contact. For further information, please contact your local Vauxhall Retailer or visit [www.vauxhall.co.uk/leasing](http://www.vauxhall.co.uk/leasing)

## In the event of an accident

Vauxhall Accident Management helps keep you mobile following an accident. Benefits include vehicle recovery, Vauxhall-approved repairs and contacting your insurer. For more details, visit [www.vauxhall.co.uk/AccidentManagement](http://www.vauxhall.co.uk/AccidentManagement)

## Vehicle Excise Duty

The amount of Vehicle Excise Duty (road fund licence) payable on new cars varies depending on the level of carbon dioxide (CO<sub>2</sub>) emissions produced by the vehicle. CO<sub>2</sub> emissions are measured in grams per kilometre (g/km) travelled and divided into 13 charging bands shown in the table opposite.

A 'first year rate' of Vehicle Excise Duty is payable on all new cars and in subsequent years the amount payable reverts to the 'standard rate'. From 1 April 2017 the breakpoints for each of these bands have been revised. Also, for vehicles with a list price over £40,000, including factory-fitted options, an additional £310 is payable for the first five years of standard rate payments.

## Vehicle Excise Duty\*

Band	CO <sub>2</sub> emissions in grams per kilometre	First year rate		
		Petrol <sup>#</sup>	Diesel <sup>†</sup>	Standard rate
A	0	£0	£0	£0
B	1-50	£10	£25	£140
C	51-75	£25	£105	£140
D	76-90	£105	£125	£140
E	91-100	£125	£145	£140
F	101-110	£145	£165	£140
G	111-130	£165	£205	£140
H	131-150	£205	£515	£140
I	151-170	£515	£830	£140
J	171-190	£830	£1,240	£140
K	191-225	£1,240	£1,760	£140
L	226-255	£1,760	£2,070	£140
M	over 255	£2,070	£2,070	£140

## Insurance Groups

	SE (a/c) / SE Nav / SL			ROCKS
	SE	SE Nav / SL	ROCKS	
1.0 (73PS)	4E	5E	5E	

## Tyre Rating

Tyre size	Fuel efficiency group	Wet grip performance	External noise	
			Measured (dB)	Group
185/55 R 15	B-C	B	71	
195/45 R 16	C	B	72	

Tyre rating according to EU Regulation 1222/2009

\*Correct at time of issue.

<sup>#</sup>Also applies to diesel vehicles that meet the Real Driving Emissions Step 2 (RDE2).

<sup>†</sup>Applies to vehicles that do not meet the Real Driving Emissions Step 2 (RDE2).





# FURTHER INFORMATION

## Customer Care Commitment

For added peace of mind, Vauxhall has an innovative Customer Care Commitment that offers the following:

- Three-year vehicle warranty consisting of a one-year/unlimited mileage manufacturer's warranty and a second and third year manufacturer's warranty with a 60,000 miles limitation
- Vauxhall Assistance for 12 months from first registration
- Six years' body panel anti-perforation warranty

**Please note:** Warranty is only available on vehicles sourced from Vauxhall Motors Limited. Terms and conditions apply. Please see your Vauxhall Retailer for details.

## Vauxhall Assistance

Vauxhall Assistance is provided automatically with every new Vauxhall for 12 months from first registration and covers everything from accident assistance, roadside recovery and 'at home' service to flat tyres. With Vauxhall Assistance help is literally just a free\* phone call away, 24 hours a day, 365 days a year!

\*Mobile phone users will be charged at their standard tariff.

## Protecting the environment

Vauxhall's commitment to the environment is demonstrated by our products' many environmental awards. For even more information on Vauxhall's efforts to achieve an environmentally sustainable future, and how to dispose of your end-of-life vehicle, see [www.vauxhall.co.uk/recycling](http://www.vauxhall.co.uk/recycling)

## Vauxhall Service Plan

- Fixed monthly payments for the plan duration
- Easy to budget and interest-free
- Genuine parts fitted by Vauxhall-trained technicians  
Plus on Gold plans:
- Valet and courtesy car
- Full AA cover
- Engine flush and fuel treatments
- Litre of oil for top ups between services

Full details can be obtained from your local participating Vauxhall Retailer.

## Vauxhall Insurance with added reassurance

Comprehensive cover – Summary of benefits\*\*

- Competitive premiums
- Repairs by a Vauxhall-trained technician
- Genuine Vauxhall parts, guaranteed for three years when we repair your car within our Approved Repairer Network
- Free courtesy car as standard when using an Approved Repairer<sup>†</sup>
- 24 hour claims helpline
- Personal Accident benefit
- Cover for audio equipment
- Windscreen cover

Call for a quote on **0844 463 2670**<sup>††</sup>

\*\*The benefits listed above are for comprehensive cover only. For details of Third Party, Fire and Theft cover, please call our sales team.

<sup>†</sup>Should your car need repairing following an accident we provide a courtesy car (subject to availability) for the duration of the repair. Only genuine Vauxhall parts are used. Terms and conditions apply.

<sup>††</sup>Calls may be recorded. Vauxhall Insurance is underwritten by Ageas Insurance Limited.

## For more product information

For a brochure on any Vauxhall model (up to a maximum of three per caller) or location of your nearest Vauxhall Retailer please call **0345 600 1500**. Alternatively, details can be found on our website at [www.vauxhall.co.uk](http://www.vauxhall.co.uk)

## Join us online



**VAUXHALL**

[vauxhall.co.uk](http://vauxhall.co.uk)

©2018 Vauxhall Motors Limited

Published 5 April 2018 Vauxhall Motors Limited