

ADAM PRICE/SPECIFICATION GUIDE

3 January 2017 | Model Year 2017.5



**PROUD SPONSOR OF OUR
NATIONAL FOOTBALL TEAMS**



ADAM CUSTOMER OFFERS

At Vauxhall we know that customers appreciate flexibility. Not only do we have an extensive range of ADAM models to choose from, but we have a range of ways to purchase too. Here's an example of our personal contract purchase offer:



£1,600
Vauxhall Deposit Contribution

3.7% APR
Representative Flexible PCP*

For even more great deals contact your local Retailer or call 0345 600 1500 or visit www.vauxhall.co.uk/offers

TERMS AND CONDITIONS: *Offer subject to availability at participating Retailers only. Personal Contract Purchase. Finance subject to status, terms and conditions apply. Applicants must be 18+. Finance by Vauxhall Finance, PO Box 6666, CF15 7YT. Vauxhall Deposit Contribution only available when vehicle financed through Vauxhall Finance. At the end of the agreement there are three options: i) Retain the vehicle: Pay the optional final payment to own the vehicle, ii) Return the vehicle, or iii) Replace: Part Exchange the vehicle, where equity is available. Offer applies to private individuals, Vauxhall Partners and small businesses 1-24 units (purchase only excluding B2B supported units). All other customers are excluded. Offer available on orders or registrations between 19 December 2016 and 3 April 2017.

ADAM COMPANY CAR DRIVER/FLEET INFORMATION

COMPANY CAR DRIVER FREE* 3 DAY TEST DRIVE



Our free* 3 Day Test Drive programme is open to all Company Car Drivers which allows you to choose any model in the current Vauxhall line-up (excluding all VXR models and Commercial Vehicles), with full insurance cover provided, to give you a meaningful length of time to make an informed decision about your next company car.

Click below to book your free* test drive
www.vauxhall3dtd.co.uk
or call **0870 240 4848****

*The free 3 Day Test Drive programme is open to Company Car Drivers and excludes fuel and lubricants; congestion charges; parking and speeding fines and the £250 insurance excess (if applicable). It features a wide selection of models from the Vauxhall range (excluding all VXR models and Commercial Vehicles and subject to availability). Drivers must be aged 25 years or over, have held a full driving licence for at least a year and hold a major credit card. You will need to have your driving licence (and proof of identity (i.e. passport) where the driving licence is not a photocard licence) when your car is delivered. While every effort will be made to ensure that at least 3 days are provided for the test drive, this cannot always be guaranteed due to delivery and collection dates and timings. Available for UK Mainland only. Terms and conditions apply. **Telephone lines open Monday-Friday 9.00am to 5.00pm excluding Bank Holidays. Calls may be recorded or monitored for quality and/or training purposes.

FLEET TOOLBOX



Discover the facts in our online Toolbox for both Company Car Drivers and Fleet Decision Makers. The Fleet Toolbox has a host of useful calculators, comparators, interactive listings and information. Visit the Fleet Toolbox by going to www.vauxhall-toolbox.co.uk

ROADTRIP APP



The Vauxhall RoadTrip App is a free app that calculates and logs your mileage expenses for any UK business trips and generates reports to help you complete your mileage claims. Available for both iPhone and Android, visit www.vauxhall-toolbox.co.uk or visit the iPhone or Android stores and search for Vauxhall RoadTrip to download it to your smartphone or tablet.

BENEFIT IN KIND COMPANY CAR TAXATION†

The car benefit charge will be the car's list price (including VAT, options and accessories fitted, delivery to Retailer and number plates, but excluding Vehicle Excise Duty and new vehicle first registration fee) multiplied by the percentage charge for the CO₂ emissions band in which the car falls (see table opposite). Multiply this figure by your personal income tax rate (20% for Basic Rate, 40% for Higher Rate) to calculate your annual benefit in kind tax liability.

Example:

| | |
|--|-----------|
| ADAM JAM 1.2i (70PS) (CO ₂ emissions 125g/km) | |
| On-the-road RRP | £12420.00 |
| Deduct: Vehicle Excise Duty | (£0.00) |
| New vehicle first registration fee | (£55.00) |
| Effective list price | £12365.00 |
| Add: Optional two-coat metallic paint | £555.00 |
| List price for tax purposes (P11D value) | £12920.00 |

| | |
|---|----------|
| Car benefit charge | |
| 2016-17 tax year (22%) | £2842.00 |
| Benefit in kind tax liability (2016-17 tax year) | |
| Basic Rate (20%) tax payer | £568.40 |
| Higher Rate (40%) tax payer | £1136.80 |

† = Please note this Price Guide provides taxation information as a guide only. Vauxhall does not provide taxation guidance. Drivers should always take professional advice on their own tax position.

| CO ₂ emissions in grams per kilometre | Percentage of car's price to be taxed | |
|--|---------------------------------------|-------------------------|
| | Petrol 2016-17 tax year | Diesel 2016-17 tax year |
| up to 50 | 7 | 10 |
| 51-75 | 11 | 14 |
| 76-94 | 15 | 18 |
| 95-99 | 16 | 19 |
| 100-104 | 17 | 20 |
| 105-109 | 18 | 21 |
| 110-114 | 19 | 22 |
| 115-119 | 20 | 23 |
| 120-124 | 21 | 24 |
| 125-129 | 22 | 25 |
| 130-134 | 23 | 26 |
| 135-139 | 24 | 27 |
| 140-144 | 25 | 28 |
| 145-149 | 26 | 29 |
| 150-154 | 27 | 30 |
| 155-159 | 28 | 31 |
| 160-164 | 29 | 32 |
| 165-169 | 30 | 33 |
| 170-174 | 31 | 34 |
| 175-179 | 32 | 35 |
| 180-184 | 33 | 36 |
| 185-189 | 34 | 37 |
| 190-194 | 35 | 37 |
| 195-199 | 36 | 37 |
| 200 and above | 37 | 37 |

To calculate your own personal liability a car tax calculator is available at: <https://www.vauxhallfleet.co.uk/toolbox>

CONTACT VAUXHALL FLEET

Please contact one of our dedicated sales teams who will be happy to help with your particular enquiry.

Company Car Drivers

Call: **0345 111 2020**

Email: company-car@vauxhallinfo.co.uk

Telephone lines are open

– Monday to Friday 8.00am-9.00pm

– Saturday and Sunday 9.00am-6.00pm

Fleet Decision Makers

Depending on the size of your fleet of vehicles, we have a dedicated team to handle your enquiries. The lines are open Monday to Friday excluding Bank Holidays.

1-24 vehicles

Call: **0845 076 2254** (8.30am-5.00pm)

Email: b2bsales@vauxhall.co.uk

25+ vehicles

Call: **0870 010 0651** (8.30am-5.00pm)

Email: vauxhallfleet@vauxhall.co.uk

Special Vehicles (Police, Fire and Ambulance)

Call: **01525 408 320** (8.30am-5.00pm)

Email: vauxhallspecialvehicles@vauxhall.co.uk

ADAM RANGE HIGHLIGHTS

ADAM JAM £12,420-£12,595

Standard features include:

- 16-inch Titan Triple Cross alloy wheels
- Air conditioning
- CD player with USB facility and aux-in socket
- Bluetooth® mobile phone portal
- Music streaming via Bluetooth®
- Steering wheel mounted audio controls
- Leather-covered steering wheel
- Imix Black Cloth seats
- Cruise control and trip computer
- Electronic Stability Programme-plus (ESP-plus)
- Anti-lock Braking System (ABS)
- Tyre pressure monitoring system
- Six airbags
- Daytime running lights

ADAM GLAM £13,790-£14,415

Standard features include:

- 16-inch Silver Vintage alloy wheels
- Electronic climate control
- Fixed glass roof panel with sliding blind
- CD player with USB facility and aux-in socket
- Digital radio
- Bluetooth® mobile phone portal
- Music streaming via Bluetooth®
- Steering wheel mounted audio controls
- Leather-covered steering wheel
- Cruise control and trip computer
- ESP-plus
- ABS
- Tyre pressure monitoring system
- Six airbags
- Body-colour door handles with chrome-effect insert
- Chrome-effect upper side window mouldings
- Chrome-effect door sill covers
- LED daytime running lights and tail lights

ADAM SLAM £14,540-£16,440

Standard features include:

- Black Jack roof and door mirrors
- Roof and door mirrors in a range of colours available at no cost
- Dark-tinted rear windows
- 17-inch Manoogian Hurricane alloy wheels
- Sports suspension
- Electronic climate control
- CD player with USB facility and aux-in socket
- Digital radio
- Bluetooth® mobile phone portal
- Music streaming via Bluetooth®
- Vauxhall OnStar
- Steering wheel mounted audio controls
- Leather-covered steering wheel
- Superheroes Black Cloth/Morrocana seats
- Cruise control and trip computer
- ESP-plus
- ABS
- Tyre pressure monitoring system
- Six airbags
- Chrome-effect upper side window mouldings
- Chrome-effect door sill covers
- LED daytime running lights and tail lights

ADAM S £17,935

Standard features include:

- 1.4i (150PS) turbocharged engine
- 18-inch Technical Grey diamond-cut Propellor alloy wheels
- Uprated brakes with red brake calipers
- Air intakes in front lower bumper
- Body-colour front lower spoiler, side sills and rear lower skirt
- Unique rear roof spoiler
- Black Jack roof and door mirrors
- Roof and door mirrors in a range of colours available at no cost
- Dark-tinted rear windows
- Red your Engine Black Cloth/Morrocana seats
- Sports suspension
- Electronic climate control
- CD player with USB facility and aux-in socket
- Digital radio
- Bluetooth® mobile phone portal
- Music streaming via Bluetooth®
- Vauxhall OnStar
- Steering wheel mounted audio controls
- Leather-covered steering wheel
- Cruise control and trip computer
- Switchable ESP-plus
- ABS
- Tyre pressure monitoring system
- Six airbags
- Chrome-effect upper side window mouldings
- Chrome-effect door sill covers
- LED daytime running lights and tail lights
- Black ADAM S velour floor mats

ADAM ENERGISED £14,265

Standard features include:

- 17-inch Black Hurricane alloy wheels
- Black Jack roof and door mirrors
- High-gloss black front grille bar
- Range of brilliant, metallic and pearlescent colours available at no cost
- Dark-tinted rear windows
- Air conditioning
- Facia and door panel inserts matched to exterior colour
- R4.0 IntelliLink with digital radio
- Ocio Black Cloth/Morrocana seats
- Sports suspension
- Bluetooth® mobile phone portal
- Music streaming via Bluetooth®
- Steering wheel mounted audio controls
- Leather-covered steering wheel
- Cruise control and trip computer
- ESP-plus
- ABS
- Tyre pressure monitoring system
- Six airbags
- LED daytime running lights and tail lights

ADAM PRICES

| Model 3-door hatch | Price (£) | VAT (£) | Total (£) | On-the-road RRP (£) | CO ₂ (g/km) |
|---|--------------|------------|--------------|------------------------|---------------------------|
| ADAM JAM | | | | | |
| 1.2i (70PS) | 9720.83 | 1944.17 | 11665.00 | 12420.00 | 125 |
| 1.4i (87PS) | 9866.67 | 1973.33 | 11840.00 | 12595.00 | 125 |
| ADAM GLAM | | | | | |
| 1.2i (70PS) | 10862.50 | 2172.50 | 13035.00 | 13790.00 | 125 |
| 1.4i (87PS) | 11008.33 | 2201.67 | 13210.00 | 13965.00 | 125 |
| 1.4i (87PS) ecoFLEX Easytronic | 11383.33 | 2276.67 | 13660.00 | 14415.00 | 118 |
| ADAM SLAM VAUXHALL OnStar | | | | | |
| 1.2i (70PS) | 11487.50 | 2297.50 | 13785.00 | 14540.00 | 125 |
| 1.4i (87PS) | 11633.33 | 2326.67 | 13960.00 | 14715.00 | 125 |
| 1.4i (100PS) | 12112.50 | 2422.50 | 14535.00 | 15290.00 | 125 |
| 1.0i Turbo (115PS) Start/Stop ecoFLEX | 13070.83 | 2614.17 | 15685.00 | 16440.00 | 112 |
| ADAM S VAUXHALL OnStar | | | | | |
| 1.4i Turbo (150PS) Start/Stop | 14208.33 | 2841.67 | 17050.00 | 17935.00 | 139 |
| ADAM ENERGISED (SPECIAL EDITION MODEL) | | | | | |
| 1.2i (70PS) | 11258.33 | 2251.67 | 13510.00 | 14265.00 | 125 |

Please note: On-the-road recommended retail prices (RRP) include number plates and delivery to Retailer of £700.00 (inc. £116.67 VAT), 12 months' Vehicle Excise Duty and new vehicle first registration fee of £55.00. Excludes fuel and insurance.

ADAM FEATURES/OPTIONS

SAFETY

Standard features

Airbags: • Driver's airbag • Front passenger's airbag • Front seat side-impact airbags • Full-size curtain airbags for front and rear seat passengers • Deactivation switch for front passenger's front and side-impact airbags – Ensures front passenger airbags do not inflate when a child seat is fitted to the front passenger's seat

Seating: • Height-adjustable front and rear seat head restraints • Four lap and diagonal inertia-reel seatbelts • Front body-lock diagonal seatbelt pretensioner system – Tightens the seatbelt during the early stages of a frontal impact • Driver's and front passenger's lap belt pretensioner system • Front seatbelt force limiters – Reduces potential upper body injuries during a frontal impact • Anti-submarining ramps in front seats • ISOFIX child seat restraint system for rear seats incorporating top tether (does not include child seat) – Secures specially designed ISOFIX child safety seats to the vehicle itself, virtually eliminating the dangers that can result from improper installation

Electronic: • Electronic Stability Programme-plus (ESP-plus) – Reduces the possibility of losing control of the vehicle • Anti-lock Braking System (ABS) • Electronic brakeforce distribution • Cornering brake control • Emergency brake assist – Increases brakeforce applied in emergency braking situations • Hill start assist • Straight line stability control • Traction control • Adaptive brake lights – If the driver brakes hard enough to activate the ABS function the brake lights flash on and off at a frequency of five times per second, warning following vehicles that heavy braking is in progress • Tyre pressure monitoring system

Body: • Energy-absorbing steering column • Pedal release system – Reduces potential injury to the driver's legs and feet during a severe frontal impact • Laminated windscreen • Side-impact protection beams • Reinforced passenger safety cell • Deformation zones front and rear

Pedestrian: • Collapsible windscreen wiper system – Reduces the risk of head injury • Low density foam near front bumper crossmember – Reduces lower leg injuries • Plastic lower front bumper stiffener – Reduces knee injuries

| | ADAM JAM | ADAM GLAM | ADAM SLAM | ADAM S | ADAM ENERGISED | Price (£) exc. VAT | Total (£) inc. VAT |
|--|----------|-----------|-----------|--------|----------------|--------------------|--------------------|
| Additional feature Switchable Electronic Stability Programme-plus (ESP-plus) | | | | ● | | | |

SECURITY

Standard features • Remote control two-stage central deadlocking (doors, tailgate, fuel filler flap) • Visible Vehicle Identification Number (VIN) plate • Electronic engine deadlock immobiliser • Electronic theft protection for audio equipment • Driver's and front passenger's internal central locking switch • Luggage area cover • Folding key (colour-keyed to body colour on ADAM JAM, GLAM, SLAM and ENERGISED models)

| | ADAM JAM | ADAM GLAM | ADAM SLAM | ADAM S | ADAM ENERGISED | Price (£) exc. VAT | Total (£) inc. VAT |
|--|----------|-----------|-----------|--------|----------------|--------------------|--------------------|
| Additional features Locking wheel nuts | ● | ● | ● | ● | ● | | |
| Remote control security alarm system | ○ | ○ | ○ | ○ | | 216.67 | 260.00 |

FACIA, INSTRUMENTS AND CONTROLS

Standard features • Leather-covered steering wheel • Multi-function trip computer¹ • Cruise control with speed limiter function • Shift-up indication light (Start/Stop models only) • Rev counter • Digital clock with automatic RDS time adjustment • Black instruments with chrome edging • Steering column adjustable for reach and rake • Electronic odometer and trip odometer • Instrument panel light dimmer • Handbrake-on/low brake fluid level and low fuel level warning lights • Service interval monitor • Seatbelt unfastened warning light for front and rear seats

| | ADAM JAM | ADAM GLAM | ADAM SLAM | ADAM S | ADAM ENERGISED | Price (£) exc. VAT | Total (£) inc. VAT |
|--|----------|-----------|-----------|----------------|----------------|--------------------|--------------------|
| Additional features City mode button providing lighter steering at parking speeds | ● | ● | ● | | ● | | |
| Winter Pack ² • Electrically heated front seats • Electrically heated leather-covered steering wheel | ○ | ○ | ○ | ○ ³ | | 187.50 | 225.00 |

● = Standard equipment. ○ = Optional at extra cost.

¹ = Information shown in the following order: instantaneous fuel consumption, average fuel consumption, range remaining, outside temperature. ² = Fitted at no extra cost in conjunction with optional leather seat facings. ³ = Not available in conjunction with Black Track Cloth/Morrocana Recaro sports front seats.

ADAM FEATURES/OPTIONS

HEATING AND VENTILATION

Standard features • Interior pollen filter • Air recirculation with activation light • Air blend heater

| | ADAM JAM | ADAM GLAM | ADAM SLAM | ADAM S | ADAM ENERGISED | Price (£) exc. VAT | Total (£) inc. VAT |
|--|----------|-----------|-----------|--------|----------------|--------------------|--------------------|
| Additional features | | | | | | | |
| Air conditioning with four-speed fan | ● | | | | ● | | |
| Electronic climate control incorporating air conditioning with six-speed fan | | ● | ● | ● | | | |

INTERIOR FEATURES

Standard features • Driver's and front passenger's seats with reach and rake adjustment • Driver's seat height adjuster • 12-volt auxiliary power socket within centre console • Two drinks holders in rear centre console • Chrome-effect interior door handles • Colour-keyed fleece velour carpet • Front door pockets • Front assist handles • Fully carpeted and illuminated luggage area • Twin sunvisors incorporating driver's vanity mirror with cover • Courtesy lighting operated by door switches • 50/50 split-folding rear seat back

| | ADAM JAM | ADAM GLAM | ADAM SLAM | ADAM S | ADAM ENERGISED | Price (£) exc. VAT | Total (£) inc. VAT |
|---|----------------|-----------|----------------|----------------|----------------|-----------------------|--------------------|
| Additional features | | | | | | | |
| Drinks holder in front centre console with adjustable restraining strap | | ● | ● | ● | | | |
| Electro-chromatic anti-dazzle rear-view mirror | □ | □ | □ | □ | | | |
| Japan Black facia and door panel inserts | ● ⁴ | ● | ● ⁵ | N/C | | No-cost option | |
| Facia and door panel inserts matched to exterior colour | ● ⁶ | | ● ⁶ | | ● | | |
| Pearl White facia and door panel inserts | ● ⁷ | | | | | | |
| Black Cloth interior | ● | ● | | | | | |
| Black Cloth/Morrocana interior | | ○ | ● | ● | ● | 300.00 | 360.00 |
| Leather seat facings, electrically heated front seats, electrically heated leather-covered three-spoke steering wheel and front passenger's seat height adjuster | | | ○ | | | 591.67 | 710.00 |
| Recaro sports front seats, Black Track Cloth/Morrocana trim and front passenger's seat height adjuster | | | | ○ ⁸ | | 875.00 | 1050.00 |
| Recaro sports front seats, Black Nappa Leather seat facings, electrically heated front seats, electrically heated three-spoke leather-covered steering wheel and front passenger's seat height adjuster | | | | ○ | | 1350.00 | 1620.00 |
| Electrically heated front seats | □ | □ | □ | □ | | | |
| Map pocket on front seat backs | | | ● | ● | | | |
| Sports pedals | | | | ● | ● | | |

MECHANICAL FEATURES

| | ADAM JAM | ADAM GLAM | ADAM SLAM | ADAM S | ADAM ENERGISED | Price (£) exc. VAT | Total (£) inc. VAT |
|---|----------------|----------------|-----------|--------|----------------|--------------------|--------------------|
| Features | | | | | | | |
| Speed-sensitive power-assisted steering | ● | ● | ● | ● | ● | | |
| Sports suspension | ○ ⁹ | ○ ⁹ | ● | ● | ● | | |
| Five-speed manual gearbox (excluding 1.0i Turbo (115PS)/1.4i Turbo (150PS) models) | ● | ● | ● | ● | ● | | |
| Six-speed manual gearbox (1.0i Turbo (115PS)/1.4i Turbo (150PS) models only) | | | ● | ● | | | |
| Easytronic five-speed transmission with sequential manual gearshift or automatic mode (1.4i (87PS) models only) | | ▲ | | | | | |

● = Standard equipment. ○ = Optional at extra cost. ▲ = See price pages for details. □ = Available as part of an option pack. N/C = No-cost option.

⁴ = Standard on Black Jack models. Not available with other exterior colours. ⁵ = Standard on Saturday White Fever, Black Jack, Shades of Grey, Heavy Metal and Pump up the Blue models. Not available with other exterior colours. ⁶ = Standard on Orange Alert, Red 'n' Roll, James Blonde, Mint my Mind, Pump up the Blue (on ADAM JAM) and (on ADAM SLAM) Let it Blue models. Not available with other exterior colours. ⁷ = Standard on Saturday White Fever, Shades of Grey and Heavy Metal models. Not available with other exterior colours. ⁸ = Not available in conjunction with Winter Pack. ⁹ = Fitted in conjunction with optional 17-inch wheels, not available separately.

ADAM FEATURES/OPTIONS

EXTERIOR FEATURES

Standard features • Tinted glass • Heated rear window with automatic timed cut-off • Rear window wash/wipe • Electrically operated front windows with safety autoreverse and one-touch facility
 • Electrically adjustable/heated door mirrors • Black B-pillars • Lights-on audible warning • Welcome lighting • Twin gas-assisted tailgate struts







| | ADAM JAM | ADAM GLAM | ADAM SLAM | ADAM S | ADAM ENERGISED | Price (£) exc. VAT | Total (£) inc. VAT |
|--|-----------------|-----------|-----------|--------|----------------|--------------------|-----------------------|
| Additional features | | | | | | | |
| Body-colour door handles | ● | | ● | ● | ● | | |
| Body-colour door handles with chrome-effect insert | □ | ● | | | | | |
| Body-colour door mirrors | ● | ● | N/C | N/C | | | No-cost option |
| Body-colour roof | ● | ● | N/C | N/C | | | No-cost option |
| Rear roof spoiler | | | □ | | | | |
| Unique ADAM S rear roof spoiler | | | | ● | | | |
| Black Jack Roof Colour Pack • Black Jack roof and door mirrors • Dark-tinted rear windows | □ | ○ | ● | ● | ● | 254.17 | 305.00 |
| White my Fire Roof Colour Pack • White my Fire roof and door mirrors • Dark-tinted rear windows | □ | ○ | N/C | N/C | | 254.17 | 305.00 |
| Let it Blue Roof Colour Pack • Let it Blue roof and door mirrors • Dark-tinted rear windows | | | | N/C | | | No-cost option |
| Shades of Grey Roof Colour Pack ¹⁰ • Shades of Grey roof and door mirrors • Dark-tinted rear windows | | | N/C | N/C | | | No-cost option |
| Red 'n' Roll Roof Colour Pack • Red 'n' Roll roof and door mirrors • Dark-tinted rear windows | | | | N/C | | | No-cost option |
| Style Pack • Choice of White my Fire or Black Jack Roof Colour Pack • 17-inch Technical Grey Roulette alloy wheels | ○ | ○ | | | | 587.50 | 705.00 |
| Extreme Carbon Pack • Carbon fibre-effect door mirrors, front grille bar and rear-view mirror | | | ○ | | | 175.00 | 210.00 |
| Extreme Carbon Pack • Carbon fibre-effect door mirrors, front grille bar and rear-view mirror • Carbon fibre-effect inserts on lower front and rear bumpers | | | | ○ | | 237.50 | 285.00 |
| High-gloss black front grille bar | | | | | ● | | |
| Chrome-effect upper side window mouldings | □ | ● | ● | ● | | | |
| Chrome-effect door sill covers | □ | ● | ● | ● | | | |
| Sight and Light Pack One ¹¹ • Rain-sensitive windscreen wipers • Automatic lighting control with tunnel detection • Electro-chromatic anti-dazzle rear-view mirror | ○ | ○ | ○ | ○ | | 200.00 | 240.00 |
| Sight and Light Pack Two ¹² • Rain-sensitive windscreen wipers • Automatic lighting control with tunnel detection | | | ○ | ○ | | 175.00 | 210.00 |
| Daytime running lights | ● | | | | | | |
| LED daytime running lights and LED tail lights | □ | ● | ● | ● | ● | | |
| Urban Pack • Chrome-effect upper side window mouldings • Chrome-effect door sill covers • Chrome-effect inserts on exterior door handles • LED daytime running lights and tail lights • Multi-colour illumination (eight colours) of centre console, door trim and footwells • Twin sunvisors incorporating illuminated driver's and front passenger's vanity mirrors with covers | ○ | | | | | 341.67 | 410.00 |
| Fixed glass roof panel with sliding blind | | ● | | | | | |
| Rear parking distance sensors | ○ | ○ | ○ | ○ | | 237.50 | 285.00 |
| Technical Pack • R4.0 IntelliLink • Rear parking distance sensors | ○ ¹³ | ○ | ○ | ○ | | 429.17 | 515.00 |
| Dark-tinted rear windows | □ | □ | ● | ● | ● | | |
| VXR Styling Pack ¹⁴ • Body-colour front lower spoiler/side sills/rear lower skirt/rear roof spoiler | | | ○ | ● | | 633.33 | 760.00 |
| Chrome-effect exhaust tailpipe extension | | | | ● | | | |

● = Standard equipment. ○ = Optional at extra cost. □ = Available as part of an option pack. N/C = No-cost option.

¹⁰ = Not available on Heavy Metal models. ¹¹ = Not available in conjunction with optional Extreme Carbon Pack. ¹² = Only available in conjunction with optional Extreme Carbon Pack. ¹³ = ADAM JAM models do not feature digital radio. ¹⁴ = Not available on 1.2i (70PS) models. ADAM S models feature a unique rear roof spoiler.

ADAM FEATURES/OPTIONS

EXTERIOR COLOURS





| | ADAM JAM | ADAM GLAM | ADAM SLAM | ADAM S | ADAM ENERGISED | Price (£) exc. VAT | Total (£) inc. VAT |
|--|----------|-----------|-----------|--------|----------------|--------------------|--------------------|
|  <p>Orange Alert • Solid paint</p> | ● | ● | ● | | | | |
|  <p>Red 'n' Roll • Brilliant paint</p> | ○ | ○ | ○ | ● | ● | 237.50 | 285.00 |
|  <p>Saturday White Fever • Brilliant paint</p> | ○ | ○ | ○ | ○ | N/C | 237.50 | 285.00 |
|  <p>White my Fire • Brilliant paint</p> | | ○ | | | | 237.50 | 285.00 |
|  <p>James Blonde • Brilliant paint</p> | ○ | ○ | ○ | | | 237.50 | 285.00 |
|  <p>Mint my Mind • Brilliant paint</p> | ○ | ○ | ○ | | N/C | 237.50 | 285.00 |
|  <p>Black Jack • Two-coat metallic paint</p> | ○ | ○ | ○ | ○ | N/C | 462.50 | 555.00 |

● = Standard equipment. ○ = Optional at extra cost. N/C = No-cost option.

The colours reproduced may vary slightly from the actual paint colour. As a result they should be used as a guide only. Your Vauxhall Retailer has a comprehensive display of our paint samples.

ADAM FEATURES/OPTIONS

EXTERIOR COLOURS

| | ADAM JAM | ADAM GLAM | ADAM SLAM | ADAM S | ADAM ENERGISED | Price (£) exc. VAT | Total (£) inc. VAT |
|--|----------|-----------|-----------|--------|----------------|-----------------------|--------------------|
|  <p>Shades of Grey • Two-coat metallic paint</p> | ○ | ○ | ○ | ○ | | 462.50 | 555.00 |
|  <p>Goldbusters • Two-coat metallic paint</p> | | | | | N/C | No-cost option | |
|  <p>Heavy Metal • Two-coat metallic paint • Not available with Shades of Grey Roof Colour Pack</p> | ○ | ○ | ○ | ○ | | 462.50 | 555.00 |
|  <p>Pump up the Blue • Two-coat pearlescent paint</p> | ○ | ○ | ○ | ○ | | 462.50 | 555.00 |
|  <p>Let it Blue • Two-coat pearlescent paint</p> | | | ○ | ○ | N/C | 462.50 | 555.00 |
|  <p>Purple Fiction • Two-coat pearlescent paint</p> | | ○ | | | | 462.50 | 555.00 |

○ = Optional at extra cost. N/C = No-cost option.

The colours reproduced may vary slightly from the actual paint colour. As a result they should be used as a guide only. Your Vauxhall Retailer has a comprehensive display of our paint samples.

ADAM FEATURES/OPTIONS

AUDIO, COMMUNICATION AND NAVIGATION

| Features | ADAM JAM | ADAM GLAM | ADAM SLAM | ADAM S | ADAM ENERGISED | Price (£) exc. VAT | Total (£) inc. VAT |
|---|----------|-----------|-----------|--------|----------------|--------------------|--------------------|
| CD/MP3 CD player/stereo radio • CD/MP3 CD player • USB connection with iPod control • AM/FM stereo radio with 36 station presets • RDS with Traffic Programme • 20 watts per channel output | ● | ● | ● | ● | | | |
| R4.0 IntelliLink touchscreen infotainment system – For use with MP3 players, USB memory sticks, mobile phones and smartphone apps Onboard features: • 7-inch colour touchscreen • AM/FM stereo radio with 36 station presets • RDS with Traffic Programme Media connections: • USB connection with iPod control • Bluetooth® A2DP audio streaming (Advanced Audio Distribution Profile) Mobile phone portal: • Bluetooth® connectivity • Handsfree calls via steering wheel controls • Vehicle microphone • Phone book access – Contacts/last calls/missed calls etc. are mirrored on IntelliLink's display and are easily navigated using the touchscreen (features dependent on mobile phone) Smartphone interface: • Apple CarPlay™ • Android Auto™ | □ | □ | □ | □ | ● | | |
| Aux-in socket (deleted if optional Technical Pack is specified) | ● | ● | ● | ● | | | |
| Digital radio | | ● | ● | ● | ● | | |
| Number of speakers | 4* | 6 | 6 | 6 | 4 | | |
| Bluetooth® mobile phone portal | ● | ● | ● | ● | ● | | |
| Music streaming via Bluetooth® | ● | ● | ● | ● | ● | | |
| Vauxhall OnStar** | | | ● | ● | ○ | 337.50 | 405.00 |
| Steering wheel mounted audio controls | ● | ● | ● | ● | ● | | |

● = Standard equipment. □ = Available as part of an option pack.

* = 6 speakers are fitted when optional Technical Pack or rear parking distance sensors are specified. ** = Includes 12 months of OnStar services from date of first registration and a 3 month/3 GB Wi-Fi free trial period (whichever comes first) effective from the date the customer accepts the nominated network operator Wi-Fi Ts&Cs. Does not include destination download feature. Theft alert feature only operates if optional security alarm system is specified.

VAUXHALL ONSTAR – YOUR PERSONAL ON BOARD ASSISTANT

Many car brands talk about innovation as soon as they improve their cup holders but this innovative system, now available on selected models†, is revolutionary: 24/7, 365 days a year, Vauxhall OnStar puts you in touch with a trained advisor, not a machine. With OnStar you have access to a host of innovations, from Vehicle Diagnostics and Smartphone Function to a fully integrated 4G Wi-Fi Hotspot††. In the event of an accident, Vauxhall OnStar even automatically calls for help, for an incomparable feeling of safety.

† = The OnStar Services require activation and are subject to mobile network coverage and availability. Wi-Fi Hotspot service requires account with nominated network operator.

†† = 4G is subject to mobile network coverage and availability. Charges apply after the free trial period. The OnStar subscription packages could be different from the services included in the free trial package. Check www.vauxhall.co.uk/onstar for terms and conditions, details of availability, coverage and charges.

DIGITAL RADIO

Now widely available in the UK, digital radio broadcasts offer the user a variety of advantages over traditional FM, starting with the digital quality sound which is immune to any hiss or crackle.

You'll often find a broader range of stations on offer too, many of which are not available on FM, and listening to them couldn't be easier – you simply select the station, by name, from the displayed list, thus removing the need to retune or look for stations when travelling around. Some stations will even display the artists' names and song titles on the car's graphic display, while they're played.

INTELLILINK

IntelliLink is Vauxhall's next-generation in-car infotainment system. It features a 7-inch colour touchscreen that enables access to, and operation of, a wide range of functions including music, video, phone, navigation and internet services.

The system isn't equipped with a CD or DVD player. Instead, it's designed to support the latest media sources including Bluetooth® and USB devices, together with smartphones and their applications. All of these features are accessed through the touchscreen's Home menu.

Since many of these features are accessed via smartphone, the IntelliLink unit is designed to allow application updates as and when they become available, thus enabling it to make use of the latest smartphone developments as they happen.







Music can be played either through the radio or from personal music players via USB connection or Bluetooth® audio streaming. When played via USB, IntelliLink's built-in Gracenote® link provides song information and album artwork. Films and slide shows can also be viewed via the USB connection, but this facility is disabled when the car is moving.

IntelliLink is able to pair with up to four Bluetooth® phones simultaneously, with each phone's address book downloaded to the audio unit so that the car effectively becomes the phone. Phone priority can then be set through the touchscreen display.

The smartphone link works in conjunction with Apple CarPlay (including Siri Eyes Free), and Android Auto. These give access to satellite navigation and a wide range of internet radio stations.

ADAM FEATURES/OPTIONS

WHEELS AND TYRES

| Features | | ADAM JAM | ADAM GLAM | ADAM SLAM | ADAM S | ADAM ENERGISED | Price (£) exc. VAT | Total (£) inc. VAT |
|---|--|----------|-----------|-----------|--------|----------------|-----------------------|--------------------|
| Emergency spare wheel (in lieu of emergency tyre inflation kit) | | ○ | ○ | ○ | | | 91.67 | 110.00 |
|  | 16-inch Titan Triple Cross alloy wheels • 195/55 R 16 tyres Emergency tyre inflation kit (in lieu of spare wheel) | ● | | | | | | |
|  | 16-inch Silver Vintage alloy wheels • 195/55 R 16 tyres Emergency tyre inflation kit (in lieu of spare wheel) | | ● | | | | | |
|  | 17-inch Manoojian Hurricane alloy wheels • 215/45 R 17 tyres Emergency tyre inflation kit (in lieu of spare wheel) | | | ● | | | | |
|  | 17-inch Gloss Black Hurricane alloy wheels • 215/45 R 17 tyres Emergency tyre inflation kit (in lieu of spare wheel) | | | N/C | | ● | No-cost option | |
|  | 17-inch Technical Grey Roulette alloy wheels • 215/45 R 17 tyres Emergency tyre inflation kit (in lieu of spare wheel) | □ | ○ | | | | 341.67 | 410.00 |
|  | 18-inch Silver Turbine alloy wheels • 225/35 R 18 tyres Emergency tyre inflation kit (in lieu of spare wheel) | | | ○ | | | 675.00 | 810.00 |
|  | 18-inch Technical Grey Propellor diamond-cut alloy wheels • 225/35 R 18 tyres Emergency tyre inflation kit (in lieu of spare wheel) | | | | ● | | | |

● = Standard equipment. ○ = Optional at extra cost. □ = Available as part of an option pack. N/C = No-cost option.

ADAM SPECIFICATIONS

PETROL ENGINES

| | 1.2i (70PS) ECOTEC-4 | 1.4i (87PS) ECOTEC-4 | 1.4i (100PS) ECOTEC-4 |
|-----------------------|--|--|--|
| Capacity | 1229cc | 1398cc | 1398cc |
| Maximum power | 70PS (51kW) @ 5600rpm | 87PS (64kW) @ 6000rpm | 100PS (74kW) @ 6000rpm |
| Maximum torque | 115Nm (85 lb.ft.) @ 4000rpm | 130Nm (96 lb.ft.) @ 4000rpm | 130Nm (96 lb.ft.) @ 4000rpm |
| Configuration | 4 cylinders, 4 valves per cylinder, double overhead camshafts | 4 cylinders, 4 valves per cylinder, double overhead camshafts | 4 cylinders, 4 valves per cylinder, double overhead camshafts |
| Fuel/induction system | Naturally aspirated. Variable Valve Timing. Multi-point sequential fuel injection | Naturally aspirated. Variable Valve Timing. Multi-point sequential fuel injection | Naturally aspirated. Variable Valve Timing. Multi-point sequential fuel injection |
| Emission compliance | Euro 6 | Euro 6 | Euro 6 |
| Service interval | 20,000 miles or 1 year (whichever occurs sooner) | 20,000 miles or 1 year (whichever occurs sooner) | 20,000 miles or 1 year (whichever occurs sooner) |

| | 1.0i Turbo (115PS) with Start/Stop | 1.4i Turbo (150PS) ECOTEC-4 with Start/Stop |
|-----------------------|--|---|
| Capacity | 998cc | 1364cc |
| Maximum power | 115PS (85kW) @ 5200rpm | 150PS (110kW) @ 4900-5500rpm |
| Maximum torque | 170Nm (125 lb.ft.) @ 1800-4500rpm | 220Nm (162 lb.ft.) @ 2750-4500rpm |
| Configuration | 3 cylinders, 4 valves per cylinder, double overhead camshafts | 4 cylinders, 4 valves per cylinder, double overhead camshafts |
| Fuel/induction system | Water-cooled turbocharger with intercooler. Variable Valve Timing (VVT) Central direct injection | Water-cooled turbocharger with intercooler. Variable Valve Timing (VVT) Multi-point sequential fuel injection |
| Emission compliance | Euro 6 | Euro 6 |
| Service interval | 20,000 miles or 1 year (whichever occurs sooner) | 20,000 miles or 1 year (whichever occurs sooner) |

PERFORMANCE, FUEL ECONOMY AND EMISSIONS

| | Wheel size (inches) | Performance (manufacturer's figures) | | Fuel economy mpg (litres/100km)# | | | CO ₂ emissions g/km# | Vehicle Excise Duty* | | Benefit in kind company car taxation rates - 2016/17 tax year |
|---------------------------------------|---------------------|--------------------------------------|----------------------------|----------------------------------|---------------------|-----------------|---------------------------------|----------------------|---------------|---|
| | | Maximum speed (mph) | Acceleration 0-62mph (sec) | Urban driving | Extra-urban driving | Combined figure | | First year rate | Standard rate | |
| Manual | | | | | | | | | | |
| 1.2i (70PS) | 16/17/18 | 103 | 14.9 | 39.2 (7.2) | 65.7 (4.3) | 53.3 (5.3) | 125 | £0 | £110 | 22% |
| 1.4i (87PS) | 16/17/18 | 109 | 12.5 | 39.8 (7.1) | 62.8 (4.5) | 52.3 (5.4) | 125 | £0 | £110 | 22% |
| 1.4i (100PS) | 17/18 | 115 | 11.5 | 39.8 (7.1) | 62.8 (4.5) | 52.3 (5.4) | 125 | £0 | £110 | 22% |
| 1.0i Turbo (115PS) Start/Stop ecoFLEX | 17/18 | 121 | 9.9 | 47.1 (6.0) | 67.3 (4.2) | 57.6 (4.9) | 112 | £0 | £30 | 19% |
| 1.4i Turbo (150PS) Start/Stop | 18 | 130 | 8.5 | 37.2 (7.6) | 57.6 (4.9) | 47.9 (5.9) | 139 | £130 | £130 | 24% |
| Easytronic | | | | | | | | | | |
| 1.4i (87PS) ecoFLEX | 16/17 | 111 | 13.9 | 42.8 (6.6) | 68.9 (4.1) | 56.5 (5.0) | 118 | £0 | £30 | 20% |

* = Correct at time of publication.

= Fuel consumption information is official government environmental data, tested in accordance with the relevant EU directive. Official EU-regulated test data is provided for comparison purposes and actual performance will depend on driving style, road conditions and other non-technical factors.

ADAM SPECIFICATIONS

TRANSMISSION

Five-speed manual gearbox:

Standard on all models (except 1.0i Turbo (115PS)/1.4i Turbo (150PS)).

Six-speed manual gearbox:

Standard on 1.0i Turbo (115PS)/1.4i Turbo (150PS) models only.

Five-speed Easytronic transmission:

Available at extra cost on 1.4i (87PS) ADAM GLAM models only. Easytronic transmission is a five-speed manual gearbox with a fully automatic mode. In manual mode you simply push the lever forward or back to shift gears up or down sequentially. The facia display tells you what gear you're in – 1 to 5.

N for Neutral or A for Auto. Switch to fully automatic mode and it has many of the features of a regular automatic including a kickdown function. There's no clutch pedal so you can drive it on an automatic-only driving licence.

STEERING

- Speed-sensitive power-assisted steering

SUSPENSION

Front: Independent. MacPherson struts with gas-pressure dampers and coil springs. Anti-roll bar.

Rear: Compound crank with coil springs and gas-pressure dampers.

BRAKING AND STABILITY

- Electronic Stability Programme – switchable on ADAM S models
- Cornering brake control
- Straight line stability control
- Anti-lock Braking System (ABS)
- Electronic brakeforce distribution
- Emergency brake assist
- Dual circuit, diagonally split braking system
- ADAM S models feature red calipers

1.2i (70PS)/1.4i (87PS)

Front ventilated discs: 257mm diameter

Rear drums: 203mm diameter

1.4i (100PS)

Front ventilated discs: 257mm diameter

Rear drums: 228mm diameter

1.0i Turbo (115PS)

Front ventilated discs: 284mm diameter

Rear drums: 228mm diameter

1.4i Turbo (150PS)

Front ventilated discs: 308mm diameter

Rear discs: 264mm diameter

FUEL TANK CAPACITY

- 38 litres (8.4 gallons)

GROSS VEHICLE WEIGHTS kg

| | |
|--------------------|------|
| 1.2i (70PS) | 1470 |
| 1.4i (87PS) | 1480 |
| 1.4i (100PS) | 1480 |
| 1.0i Turbo (115PS) | 1510 |
| 1.4i Turbo (150PS) | 1565 |

Gross vehicle weight is the total permissible weight of the vehicle including passengers and luggage. The maximum roof rack loading should not exceed 50kg.

TYRE RATING

| Tyre size | Fuel efficiency group | Wet grip performance | External noise | |
|-------------|-----------------------|----------------------|----------------|-------|
| | | | Measured (dB) | Group |
| 195/55 R 16 | B-C | B | 71 | (A) |
| 215/45 R 17 | C | B | 71 | (A) |
| 225/35 R 18 | C | B | 77 | (A) |

Tyre rating according to EU Regulation 1222/2009

EXTERIOR DIMENSIONS millimetres (inches)

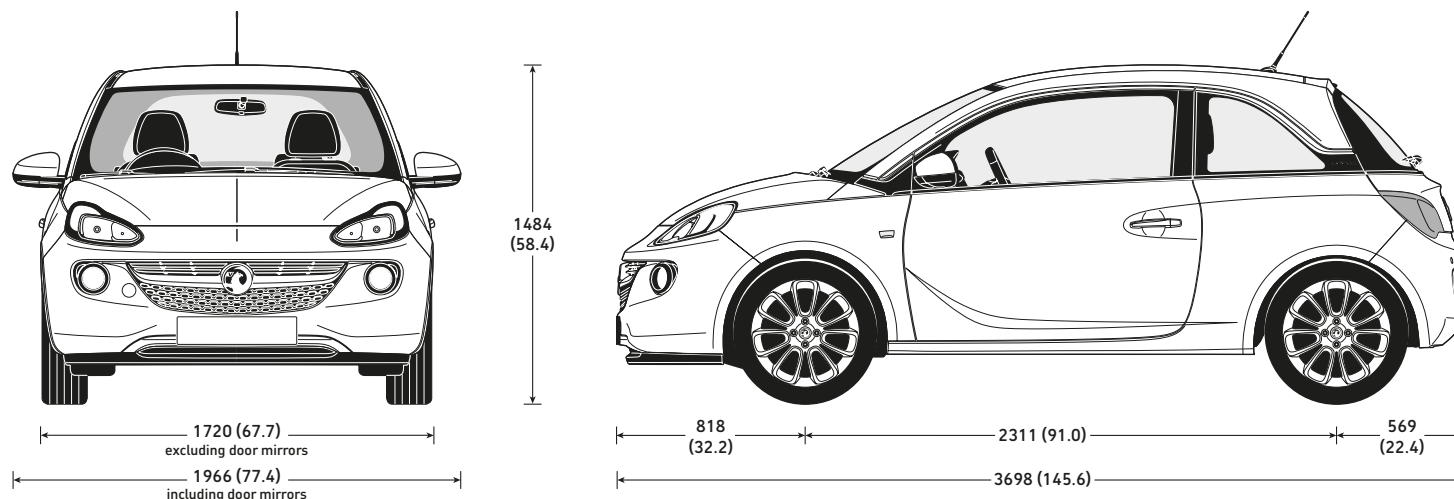

LOADSPACE DIMENSIONS millimetres (inches)

| | |
|------------------------------------|-------------|
| Maximum length (behind rear seats) | 462 (18.2) |
| Maximum length (rear seats folded) | 1041 (41.0) |
| Maximum width | 963 (37.9) |
| Width between wheel arches | 954 (37.6) |
| Maximum height | 874 (34.4) |

LUGGAGE CAPACITIES* litres (cu.ft.)

| | |
|--|------------|
| Rear seats up (under luggage compartment cover) | 170 (6.0) |
| Rear seats folded (to upper edge of front seat back) | 484 (17.1) |
| Rear seats folded (to roof) | 663 (23.4) |

* = Measured using the ECIE method.

ADAM ACCESSORIES

| | Total (inc. VAT) | | Total (inc. VAT) | | Total (inc. VAT) | | Total (inc. VAT) |
|--|------------------|---|------------------|---|------------------|--|------------------|
| CHILD SEATS¹ | | EXTERIOR | | TRANSPORT SYSTEMS | | ALLOY WHEELS (set of four with centre caps)⁴ | |
| BABY-SAFE ² – 0-13kg/birth to 15 months | £132.00 | Door mirror caps (fitted) | from £105.00 | Roof base carrier | £137.00 | 16-inch Horns | |
| – ISOFIX base | £227.00 | Painted logo bar (fitted) | from £88.00 | Roof carriers (requires base carrier) | | – Silver | £811.00 |
| DUO ISOFIX ² – 9-18kg/9 months to 4 years | | 'Fly' decals | | Bike roof carrier – Thule Freeride 532 | £76.00 | – Black | £1052.00 |
| with top tether kit | £347.00 | – B-pillar decal (fitted) | £51.00 | Surf board roof carrier – Thule 833 | £101.00 | 16-inch Vintage | £954.00 |
| KID ² – 15-36kg or 4 to 12 years | £157.00 | – C-pillar decal (fitted) | £160.00 | Kayak roof carrier – Thule 837 | £168.00 | 16-inch Boomerang | |
| | | 'Splat' graphics | | Ski roof carrier (400mm wide) | | – Grey / diamond cut face | £758.00 |
| | | Front wing/rear quarter decals (fitted) | from £128.00 | – Thule Deluxe 726 | £ 138.00 | – Green / diamond cut face | £1059.00 |
| | | 'Sport 01' graphics | | Ski roof carrier (600mm wide) | | – White / diamond cut face | £1001.00 |
| | | – Bonnet decal (fitted) | from £93.00 | – Thule 739 | £235.00 | 16-inch Triple Cross | |
| | | – Roof decal (fitted) | £113.00 | Hard shell roof boxes (requires base carrier) | | Titan grey | £804.00 |
| | | – C-pillar decal (fitted) | £95.00 | Thule Ocean 80 | | Manoogian | £805.00 |
| | | 'Stripes' graphics | | (320 litre / 1330 x 860 x 370mm) | £235.00 | 18-inch Turbine | £1078.00 |
| | | – Bonnet decal (fitted) | from £130.00 | Thule Ocean 200 | | 17-inch Hurricane | |
| | | – Roof decal (fitted) | from £127.00 | (390 litre / 1750 x 820 x 450mm) | £316.00 | – Manoogian | £1165.00 |
| | | – Door decals (fitted) | from £112.00 | Thule Dynamic M | | – Black | £898.00 |
| | | – Door / door mirror decals (fitted) | from £132.00 | (320 litre / 2060 x 840 x 340mm) | from £625.00 | – White | £891.00 |
| | | 'Stars and Stripes' graphics | | Thule Dynamic L | | 17-inch Swiss Blade | |
| | | – Roof / B Pillar decals (fitted) | £193.00 | (430 litre / 2350 x 940 x 350mm) | £846.00 | – Silver | £904.00 |
| | | 'Chequered' graphics | | Thule Excellence | | – Black / white rim | £746.00 |
| | | – Roof decal (fitted) | £121.00 | (520 litre / 2180 x 940 x 400mm) | £898.00 | – Black / red rim | £1084.00 |
| | | 'Motorsport' graphics | | Thule Motion 800 | | – Black / blue rim | £1077.00 |
| | | – Bonnet / body side decals (fitted) | £350.00 | (460 litre / 2050 x 840 x 450mm) | from £515.00 | 17-inch Roulette | |
| | | Body side protection mouldings | | Thule Touring 200 | | – Grey | £884.00 |
| | | (painted/fitted) | £211.00 | (400 litre / 1750 x 820 x 450mm) | £372.00 | – Grey / diamond cut face | £1165.00 |
| | | PROTECTION | | Thule Touring 780 | | – Grey / white face | £1405.00 |
| | | Tyre sealant – 450ml | £67.00 | (430 litre / 2320 x 700 x 420mm) | £460.00 | – Grey / brown face | £1405.00 |
| | | Tyre inflation compressor | £120.00 | Soft roof boxes (requires base carrier) | | – Grey / green face | £953.00 |
| | | Safety pack – first aid kit/hi-visibility vest/ warning triangle | £35.00 | Thule Ranger 90 | | – Copper / white face | £953.00 |
| | | First aid kit | £15.00 | (280 litre / 1100 x 800 x 400mm) | £285.00 | – Copper / diamond cut face | £785.00 |
| | | Hi-visibility vest | £9.00 | Thule Ranger 500 | | – Black gloss | £898.00 |
| | | Warning triangle | £17.00 | (300 litre / 1900 x 500 x 300mm) | £378.00 | 18-inch Twister | |
| | | Spare bulb kit | £26.00 | Tailgate carrier | | – Grey | £1942.00 |
| | | Protection film – front bumper (fitted) | £167.00 | Bike tailgate carrier – Thule BacPac 973 | £282.00 | – Manoogian | £1961.00 |
| | | Protection film – rear bumper (fitted) | £56.00 | Fitting kit | £48.00 | Coloured wheel clips for Twister wheels (set of four) | from £70.00 |
| | | Privacy shades – tailgate/rear side windows | £183.00 | Flex-fix bicycle carrier – extension kit for third bicycle | £254.00 | Tyre valve caps with Vauxhall logos – set of four | £23.00 |
| | | Exterior windscreen cover | £69.00 | | | Locking wheel bolts | £43.00 |
| | | Outdoor car cover | from £288.00 | | | | |
| | | Mudflaps – front (fitted) | £63.00 | | | | |
| | | Mudflaps – rear (fitted) | £56.00 | | | | |

1 = Restrictions apply to the use of child seats, please consult your Vauxhall Retailer or request a copy of the Child seats brochure.
2 = Without transponder.

FLEXCONNECT RANGE

| | |
|-----------------------------------|---------|
| FlexConnect bracket | £20.00 |
| FlexConnect hook | £28.00 |
| FlexConnect coat hanger | £58.00 |
| FlexConnect folding table | £68.00 |
| FlexConnect iPad Mini cradle | £98.00 |
| FlexConnect iPad (1-4) cradle | £106.00 |
| FlexConnect iPad Air cradle | £106.00 |
| FlexConnect Samsung Galaxy cradle | £96.00 |

INTERIOR

| | |
|---|-------------|
| Velour floor mats (set of four) | from £56.00 |
| Rubber floor mats (set of four) | £46.00 |
| Rear view mirror cap | from £57.00 |
| Front console mat | £37.00 |
| Centre console armrest | £89.00 |
| Cargo box with lid | £183.00 |
| Coloured leather gear knob and gaiter (fitted) | from £64.00 |
| Stainless steel pedal covers – manual (fitted) | £164.00 |

VXR EXTERIOR STYLING³

| | |
|--|----------|
| VX-Line body styling – front lower spoiler/side sills/ rear lower skirts (painted/fitted) | £1581.00 |
| VX-Line body styling – rear roof spoiler (painted/fitted) | £539.00 |

3 = Not available on S models.

Please note:

Prices shown are a fully fitted and painted, where applicable and include VAT. Please check with your local Vauxhall Retailer for details. It is advisable to ensure your insurance policy is adequate to cover additional fitted accessories. Prices correct at time of publication.

4 = Different tyres and locking wheel bolts/nuts may be required at extra cost. Price excludes new tyres and locking wheel bolts/nuts, includes static wheel balancing.

ADAM ADDITIONAL INFORMATION

ON-THE-ROAD PRICES

To eliminate uncertainty about hidden costs when buying a new car, Vauxhall publishes on-the-road recommended retail prices (RRP) and these are shown in the pricing tables within this price guide. These prices include the recommended cost of number plates and delivery to a Vauxhall Retailer of £700.00 (including £116.67 VAT), 12 months' Government Vehicle Excise Duty (see opposite for details) and the DVLA new vehicle first registration fee of £55.00*.

Please note: The on-the-road recommended retail price (RRP) does not include fuel supplied by the Retailer, motor insurance or any other goods or services supplied by agreement between the Retailer and the customer.

PRICE PROTECTION

Order a new Vauxhall for build in the current model year (as confirmed by your Retailer) for delivery no more than three months in advance and the price you are quoted is the price you pay. This is irrespective of any subsequent price rises between placing your order and delivery of your new car, but you must take delivery as soon as the car is available. General Motors UK Limited is not liable for price adjustments caused by Government changes in the rate of VAT (currently 20%), Vehicle Excise Duty, DVLA new vehicle first registration fee or by any other applicable legislation or regulations.

VEHICLE EXCISE DUTY

The amount of Vehicle Excise Duty (road fund licence) payable on new cars varies depending on the level of carbon dioxide (CO₂) emissions produced by the vehicle. CO₂ emissions are measured in grammes (g) per kilometre (km) travelled and divided into 13 charging bands shown in the table below.

From 1 April 2010 the Government introduced a new 'first year rate' of Vehicle Excise Duty payable on all new cars. In subsequent years the amount of Vehicle Excise Duty payable will revert to the standard rate.

Vehicle Excise Duty*

| | CO ₂ emissions (g/km) | First year rate | Standard rate |
|---------------|----------------------------------|-----------------|---------------|
| Band A | up to 100 | £0.00 | £0.00 |
| Band B | 101-110 | £0.00 | £20.00 |
| Band C | 111-120 | £0.00 | £30.00 |
| Band D | 121-130 | £0.00 | £110.00 |
| Band E | 131-140 | £130.00 | £130.00 |
| Band F | 141-150 | £145.00 | £145.00 |
| Band G | 151-165 | £185.00 | £185.00 |
| Band H | 166-175 | £300.00 | £210.00 |
| Band I | 176-185 | £355.00 | £230.00 |
| Band J | 186-200 | £500.00 | £270.00 |
| Band K | 201-225 | £650.00 | £295.00 |
| Band L | 226-255 | £885.00 | £500.00 |
| Band M | over 255 | £1120.00 | £515.00 |

* = Correct at time of issue.

E10 FUEL

E10 fuel is cleared for use in all petrol-engined Vauxhall vehicles excluding models with the 2.2 litre petrol engine (code Z22YH) used in Vectra, Signum and Zafira models. Owners of these vehicles should continue to use regular unleaded or premium unleaded petrol.

PROTECTING THE ENVIRONMENT

Vauxhall's commitment to the environment is demonstrated by our products' many environmental awards. For even more information on Vauxhall's efforts to achieve an environmentally sustainable future, and how to dispose of your end-of-life vehicle, see www.vauxhall.co.uk/recycling

VAUXHALL ASSISTANCE

Vauxhall Assistance is provided automatically with every new Vauxhall for 12 months from first registration and covers everything from accident assistance, roadside recovery and 'at home' service to flat tyres. With Vauxhall Assistance help is literally just a free** phone call away, 24 hours a day, 365 days a year!

** = Mobile phone users will be charged at their standard tariff.

VAUXHALL LEASING

As Vauxhall's own contract hire and fleet management operation, Vauxhall Leasing provides a one-stop-shop for competitive car and van leasing solutions – for business users and private individuals. Working with the Vauxhall Retailer network, we combine the support of a national contract with the convenience of a local contact.

For further information, please see your local Vauxhall Retailer or call us on **0870 737 2557**. Alternatively, you can visit our website at www.vauxhall-leasing.co.uk

IN THE EVENT OF AN ACCIDENT...

Vauxhall Accident Management helps keep you mobile following an accident. Benefits include vehicle recovery, Vauxhall-approved repairs and contacting your insurer. For more details, visit vauxhall.co.uk/AccidentManagement

VAUXHALL SERVICE PLAN

Vauxhall Retailers offer a great service for owners of all Vauxhall cars. Value for money, regular offers and free check-ups, combined with the peace of mind that comes from using Vauxhall-trained technicians and genuine parts, help keep your car in peak condition at all times.

FOR MORE PRODUCT INFORMATION

For a brochure on any Vauxhall model (up to a maximum of three per caller) or location of your nearest Vauxhall Retailer please call **0345 600 1500**. Alternatively, details can be found on our website at www.vauxhall.co.uk

JOIN US ONLINE:



VAUXHALL INSURANCE WITH ADDED REASSURANCE

Comprehensive cover – Summary of benefits*

- Competitive premiums
- Repairs by a Vauxhall-trained technician
- Genuine Vauxhall parts, guaranteed for three years when we repair your car within our Approved Repairer Network
- Free courtesy car as standard when using an Approved Repairer**
- 24 hour claims helpline
- Personal Accident benefit
- Cover for audio equipment
- Windscreen cover

Call for a quote on 0844 463 2670†

*The benefits listed above are for comprehensive cover only. For details of Third Party, Fire and Theft cover, please call our sales team.
**Should your car need repairing following an accident we provide a courtesy car (subject to availability) for the duration of the repair. Only genuine Vauxhall parts are used. Terms and conditions apply.
†Calls may be recorded. Vauxhall Motor Insurance is underwritten by Ageas Insurance Limited.

Every effort has been made to ensure that the contents of this document were accurate and up-to-date at the time of publication – 3 January 2017. The invoice price, including delivery to Retailer, factory-fitted options, accessories fitted by the Retailer and number plates, is subject to VAT. The right is reserved to alter specifications and prices, and withdraw products from sale, without notice. Please note that Vauxhall Retailers are not the agents of General Motors UK Limited and are not authorised to bind General Motors UK Limited by any specific or implied undertaking or representation. It is advisable to ensure that your motor insurance policy provides adequate cover for additional fitted options and accessories. All rights reserved. No part of this publication may be reproduced in any form or by any means, without the prior written permission of General Motors UK Limited.

General Motors UK Limited t/a Vauxhall, Griffin House, UK1-101-135, Osborne Road, Luton, Bedfordshire, LU1 3YT. www.vauxhall.co.uk

©2017 General Motors UK Limited



VAUXHALL