

ADAM PRICE/SPECIFICATION GUIDE

3 December 2015 | Model Year 2016.5



Proud Sponsor of Home Nations Football



ADAM CUSTOMER OFFERS

At Vauxhall we know that customers appreciate flexibility. Not only do we have an extensive range of ADAM models to choose from, but we have a range of ways to purchase too. Here's an example on our personal contract hire* plus insurance offer:



THE STYLISH ADAM SLAM 1.2 1 YEAR'S INSURANCE**:

- FREE 21-75 yrs
- ONLY £99 18-20 yrs

For ONLY **£199** per month over
35 months with £1,592 advance rental

Every one's an original

For even more great deals contact your local Retailer or call 0345 600 1500

TERMS AND CONDITIONS: *Personal contract hire offer on ADAM SLAM 1.2i in Greenspotting on orders received between 8 October 2015 and 31 December 2015, subject to availability and status. Age 18+ only. Figures based on a non-maintenance contract hire package with advance rental of £1,592, then 35 monthly rentals of £199. Excess miles over contracted mileage of 24,000 over 36 months charged at 7.31 pence per mile. Excess charges also apply if you breach manufacturer servicing or maintenance guidelines or if the car exceeds BVRLA Fair Wear & Tear guidelines for its age/mileage when it is returned to Vauxhall Leasing. Package includes Road Fund Licence and Vauxhall Assistance. Guarantee/indemnity may be required. Prices and details are subject to change without notice. For full specification and Ts&Cs contact your local Retailer. **You will not own the car.** ALD Automotive Ltd., trading as Vauxhall Leasing, BS16 3JA. Authorised and regulated by the Financial Conduct Authority. **First year insurance offer available on ADAM SLAM only, excluding GRAND SLAM and S models. All drivers must have held a valid full UK licence for a minimum of 1 year. All policies are underwritten by Ageas Insurance Ltd. Other insurance specific Terms and Conditions apply. The offer will cover the full premium for drivers aged between 21-75 (motor policy only). Only available through Vauxhall Insurance. Drivers aged 18-20 will make a contribution of £99 to their premium and must agree to the fitting of a telematics box to the car: every 3 months, your contribution will be reviewed and if you drive well, we will return part of this to you. The policy may be cancelled for excessive speeding or consistently poor driving. Only available through ingenie. Refer to www.vauxhall.co.uk/offers or contact your local Retailer for details. Participating Retailers only. Offers apply to private individuals, Vauxhall Partners and small businesses 1-24 units (purchase only excluding B2B supported units). All other customers are excluded. Offers available on orders or registrations between 8 October 2015 and 31 December 2015.

ADAM COMPANY CAR DRIVER/FLEET INFORMATION

COMPANY CAR DRIVER FREE* 3 DAY TEST DRIVE



Our free* 3 Day Test Drive programme is open to all Company Car Drivers which allows you to choose any model in the current Vauxhall line-up (excluding all VXR models and Commercial Vehicles), with full insurance cover provided, to give you a meaningful length of time to make an informed decision about your next company car.

Click below to book your free* test drive
www.vauxhall3dtd.co.uk
or call **0870 240 4848****

*The free 3 Day Test Drive programme is open to Company Car Drivers and excludes fuel and lubricants; congestion charges; parking and speeding fines and the £250 insurance excess (if applicable). It features a wide selection of models from the Vauxhall range (excluding all VXR models and Commercial Vehicles and subject to availability). Drivers must be aged 25 years or over, have held a full driving licence for at least a year and hold a major credit card. You will need to have your driving licence (and proof of identity (i.e. passport) where the driving licence is not a photocard licence) when your car is delivered. While every effort will be made to ensure that at least 3 days are provided for the test drive, this cannot always be guaranteed due to delivery and collection dates and timings. Available for UK Mainland only. Terms and conditions apply. **Telephone lines open Monday-Friday 9.00am to 5.00pm excluding Bank Holidays. Calls may be recorded or monitored for quality and/or training purposes.

FLEET TOOLBOX



Discover the facts in our online Toolbox for both Company Car Drivers and Fleet Decision Makers. The Fleet Toolbox has a host of useful calculators, comparators, interactive listings and information. Visit the Fleet Toolbox by going to www.vauxhall-toolbox.co.uk

ROADTRIP APP



The Vauxhall RoadTrip App is a free app that calculates and logs your mileage expenses for any UK business trips and generates reports to help you complete your mileage claims. Available for both iPhone and Android, visit www.vauxhall-toolbox.co.uk or visit the iPhone or Android stores and search for Vauxhall RoadTrip to download it to your smartphone or tablet.

BENEFIT IN KIND COMPANY CAR TAXATION†

The car benefit charge will be the car's list price (including VAT, options and accessories fitted, delivery to Retailer and number plates, but excluding Vehicle Excise Duty and new vehicle first registration fee) multiplied by the percentage charge for the CO₂ emissions band in which the car falls (see table opposite). Multiply this figure by your personal income tax rate (20% for Basic Rate, 40% for Higher Rate) to calculate your annual benefit in kind tax liability.

Example:

ADAM JAM 1.2i 70PS (CO₂ emissions 125g/km)

On-the-road RRP £11860.00

Deduct: Vehicle Excise Duty (£0.00)

New vehicle first registration fee (£55.00)

Effective list price £11805.00

Add: Optional two-coat metallic paint
£545.00

List price for tax purposes (P11D value)
£12350.00

Car benefit charge
2015-16 tax year (20%) £2470.00

Benefit in kind tax liability
(2015-16 tax year)

Basic Rate (20%) tax payer £494.00

Higher Rate (40%) tax payer £988.00

† = Please note this Price Guide provides taxation information as a guide only. Vauxhall does not provide taxation guidance. Drivers should always take professional advice on their own tax position.

CO ₂ emissions in grams per kilometre	Percentage of car's price to be taxed	
	Petrol 2015-16 tax year	Diesel 2015-16 tax year
up to 50	5	8
51-75	9	12
76-94	13	16
95-99	14	17
100-104	15	18
105-109	16	19
110-114	17	20
115-119	18	21
120-124	19	22
125-129	20	23
130-134	21	24
135-139	22	25
140-144	23	26
145-149	24	27
150-154	25	28
155-159	26	29
160-164	27	30
165-169	28	31
170-174	29	32
175-179	30	33
180-184	31	34
185-189	32	35
190-194	33	36
195-199	34	37
200-204	35	37
205-209	36	37
210 and above	37	37

To calculate your own personal liability a car tax calculator is available at:
<https://www.vauxhallfleet.co.uk/toolbox>

CONTACT VAUXHALL FLEET

Please contact one of our dedicated sales teams who will be happy to help with your particular enquiry.

Company Car Drivers

Call: **0345 111 2020**

Email: company-car@vauxhallinfo.co.uk

Telephone lines are open

– Monday to Friday 8.00am-9.00pm

– Saturday and Sunday 9.00am-6.00pm

Fleet Decision Makers

Depending on the size of your fleet of vehicles, we have a dedicated team to handle your enquiries. The lines are open Monday to Friday excluding Bank Holidays.

1-24 vehicles

Call: **0845 076 2254** (8.30am-5.00pm)

Email: b2bsales@vauxhall.co.uk

25+ vehicles

Call: **0870 010 0651** (8.30am-5.00pm)

Email: vauxhallfleet@vauxhall.co.uk

Special Vehicles (Police, Fire and Ambulance)

Call: **01525 408 320** (8.30am-5.00pm)

Email: vauxhallspecialvehicles@vauxhall.co.uk

ADAM RANGE HIGHLIGHTS

ADAM JAM £11,860-£12,035

Standard features include:

- 16-inch Titan Triple Cross alloy wheels
- Air conditioning
- CD player with USB facility and aux-in socket
- Bluetooth® mobile phone portal
- Music streaming via Bluetooth®
- Steering wheel mounted audio controls
- Leather-covered steering wheel
- Imix Black Cloth seats
- Cruise control and trip computer
- Electronic Stability Programme-plus (ESP-plus)
- Anti-lock Braking System (ABS)
- Tyre pressure monitoring system
- Six airbags
- Daytime running lights

ADAM GLAM £13,230-£13,855

Standard features include:

- 16-inch Silver Vintage alloy wheels
- Electronic climate control
- Fixed glass roof panel with sliding blind
- CD player with USB facility and aux-in socket
- Digital radio
- Bluetooth® mobile phone portal
- Music streaming via Bluetooth®
- Steering wheel mounted audio controls
- Leather-covered steering wheel
- Cruise control and trip computer
- ESP-plus
- ABS
- Tyre pressure monitoring system
- Six airbags
- Body-colour door handles with chrome-effect insert
- Chrome-effect upper side window mouldings
- Chrome-effect door sill covers
- LED daytime running lights and tail lights

ADAM SLAM £13,980-£15,880

Standard features include:

- I'll be Black roof and door mirrors
- Roof and door mirrors in a range of colours available at no cost
- Dark-tinted rear windows
- 17-inch Manoogian Hurricane alloy wheels
- Sports suspension
- Electronic climate control
- CD player with USB facility and aux-in socket
- Digital radio
- Bluetooth® mobile phone portal
- Music streaming via Bluetooth®
- Vauxhall OnStar
- Steering wheel mounted audio controls
- Leather-covered steering wheel
- Superheroes Black Cloth/Morrocana seats
- Cruise control and trip computer
- ESP-plus
- ABS
- Tyre pressure monitoring system
- Six airbags
- Chrome-effect upper side window mouldings
- Chrome-effect door sill covers
- LED daytime running lights and tail lights

ADAM S £17,375

Standard features include:

- 1.4i 150PS turbocharged engine
- 18-inch Technical Grey diamond-cut Propellor alloy wheels
- Uprated brakes with red brake calipers
- Air intakes in front lower bumper
- Body-colour front lower spoiler, side sills and rear lower skirt
- Unique rear roof spoiler
- I'll be Black roof and door mirrors
- Roof and door mirrors in a range of colours available at no cost
- Dark-tinted rear windows
- Red your Engine Black Cloth/Morrocana seats
- Sports suspension
- Electronic climate control
- CD player with USB facility and aux-in socket
- Digital radio
- Bluetooth® mobile phone portal
- Music streaming via Bluetooth®
- Vauxhall OnStar
- Steering wheel mounted audio controls
- Leather-covered steering wheel
- Cruise control and trip computer
- Switchable ESP-plus
- ABS
- Tyre pressure monitoring system
- Six airbags
- Chrome-effect upper side window mouldings
- Chrome-effect door sill covers
- LED daytime running lights and tail lights
- Black ADAM S velour floor mats

ADAM ENERGISED £13,705

Standard features include:

- 17-inch Black Hurricane alloy wheels
- I'll be Black roof and door mirrors
- High-gloss black front grille bar
- Range of brilliant, metallic and pearlescent colours available at no cost
- Dark-tinted rear windows
- Facia and door panel inserts matched to exterior colour
- R4.0 IntelliLink with digital radio
- Ocio Black Cloth/Morrocana seats
- Sports suspension
- Bluetooth® mobile phone portal
- Music streaming via Bluetooth®
- Steering wheel mounted audio controls
- Leather-covered steering wheel
- Cruise control and trip computer
- ESP-plus
- ABS
- Tyre pressure monitoring system
- Six airbags
- LED daytime running lights and tail lights

ADAM PRICES

Model 3-door hatch	Price (£)	VAT (£)	Total (£)	On-the-road RRP (£)	CO ₂ (g/km)
ADAM JAM					
1.2i 70PS	9254.17	1850.83	11105.00	11860.00	125
1.4i 87PS	9400.00	1880.00	11280.00	12035.00	125
ADAM GLAM					
1.2i 70PS	10395.83	2079.17	12475.00	13230.00	125
1.4i 87PS	10541.67	2108.33	12650.00	13405.00	125
1.4i 87PS ecoFLEX Easytronic	10916.67	2183.33	13100.00	13855.00	118
ADAM SLAM VAUXHALL OnStar					
1.2i 70PS	11020.83	2204.17	13225.00	13980.00	125
1.4i 87PS	11166.67	2233.33	13400.00	14155.00	125
1.4i 100PS	11645.83	2329.17	13975.00	14730.00	125
1.0i 115PS Turbo Start/Stop ecoFLEX	12604.17	2520.83	15125.00	15880.00	115
ADAM S VAUXHALL OnStar					
1.4i 150PS Turbo Start/Stop	13741.67	2748.33	16490.00	17375.00	139
ADAM ENERGISED (SPECIAL EDITION MODEL)					
1.2i 70PS	10791.67	2158.33	12950.00	13705.00	125

Please note: On-the-road recommended retail prices (RRP) include number plates and delivery to Retailer of £700.00 (inc. £116.67 VAT), 12 months' Vehicle Excise Duty and new vehicle first registration fee of £55.00. Excludes fuel and insurance.

ADAM PRICES pre-2016 model year vehicles*

Model 3-door hatch	Price (£)	VAT (£)	Total (£)	On-the-road RRP (£)	CO ₂ (g/km)
ADAM JAM					
1.2i 70PS	9254.17	1850.83	11105.00	11860.00	125
1.4i 87PS	9400.00	1880.00	11280.00	12035.00	125
1.0i 115PS Turbo Start/Stop ecoFLEX	10837.50	2167.50	13005.00	13760.00	114
ADAM GLAM					
1.2i 70PS	10395.83	2079.17	12475.00	13230.00	125
1.4i 87PS	10541.67	2108.33	12650.00	13405.00	125
ADAM SLAM					
1.2i 70PS	10812.50	2162.50	12975.00	13730.00	125
1.4i 87PS	10958.33	2191.67	13150.00	13905.00	125
1.4i 100PS	11437.50	2287.50	13725.00	14480.00	125
1.4i 100PS Start/Stop ecoFLEX	11683.33	2336.67	14020.00	14775.00	119
1.0i 115PS Turbo Start/Stop ecoFLEX	12395.83	2479.17	14875.00	15630.00	119
ADAM S					
1.4i 150PS Turbo Start/Stop	13533.33	2706.67	16240.00	17125.00	139

Please note: On-the-road recommended retail prices (RRP) include number plates and delivery to Retailer of £700.00 (inc. £116.67 VAT), 12 months' Vehicle Excise Duty and new vehicle first registration fee of £55.00. Excludes fuel and insurance.

* = Please note that stocks are limited and that specifications may differ from those described in this Price Guide – consult your Retailer for further details.

ADAM FEATURES/OPTIONS

SAFETY

Standard features

Airbags: • Driver's airbag • Front passenger's airbag • Front seat side-impact airbags • Full-size curtain airbags for front and rear seat passengers • Deactivation switch for front passenger's front and side-impact airbags – Ensures front passenger airbags do not inflate when a child seat is fitted to the front passenger's seat

Seating: • Height-adjustable front and rear seat head restraints • Four lap and diagonal inertia-reel seatbelts • Front body-lock diagonal seatbelt pretensioner system – Tightens the seatbelt during the early stages of a frontal impact • Driver's and front passenger's lap belt pretensioner system • Front seatbelt force limiters – Reduces potential upper body injuries during a frontal impact • Anti-submarining ramps in front seats • ISOFIX child seat restraint system for rear seats incorporating top tether (does not include child seat) – Secures specially designed ISOFIX child safety seats to the vehicle itself, virtually eliminating the dangers that can result from improper installation

Electronic: • Electronic Stability Programme-plus (ESP-plus) – Reduces the possibility of losing control of the vehicle • Anti-lock Braking System (ABS) • Electronic brakeforce distribution • Cornering brake control • Emergency brake assist – Increases brake force applied in emergency braking situations • Hill start assist • Straight line stability control • Traction control • Adaptive brake lights – If the driver brakes hard enough to activate the ABS function the brake lights flash on and off at a frequency of five times per second, warning following vehicles that heavy braking is in progress • Tyre pressure monitoring system

Body: • Energy-absorbing steering column • Pedal release system – Reduces potential injury to the driver's legs and feet during a severe frontal impact • Laminated windscreen • Side-impact protection beams • Reinforced passenger safety cell • Deformation zones front and rear

Pedestrian: • Collapsible windscreen wiper system – Reduces the risk of head injury • Low density foam near front bumper crossmember – Reduces lower leg injuries • Plastic lower front bumper stiffener – Reduces knee injuries

Additional feature	ADAM JAM	ADAM GLAM	ADAM SLAM	ADAM S	ADAM ENERGISED	Price (£) exc. VAT	Total (£) inc. VAT
Switchable Electronic Stability Programme-plus (ESP-plus)				●			

SECURITY

Standard features • Remote control two-stage central deadlocking (doors, tailgate, fuel filler flap) • Visible Vehicle Identification Number (VIN) plate • Electronic engine deadlock immobiliser • Electronic theft protection for audio equipment • Driver's and front passenger's internal central locking switch • Luggage area cover • Folding key (colour-keyed to body colour on ADAM JAM, GLAM, SLAM and ENERGISED models)

Additional features	ADAM JAM	ADAM GLAM	ADAM SLAM	ADAM S	ADAM ENERGISED	Price (£) exc. VAT	Total (£) inc. VAT
Locking wheel nuts	●	●	●	●	●		
Remote control security alarm system	○	○	○	○	○	208.33	250.00

FACIA, INSTRUMENTS AND CONTROLS

Standard features • Leather-covered steering wheel • Multi-function trip computer¹ • Cruise control with speed limiter function • Shift-up indication light (Start/Stop models only) • Rev counter • Digital clock with automatic RDS time adjustment • Black instruments with chrome edging • Steering column adjustable for reach and rake • Electronic odometer and trip odometer • Instrument panel light dimmer • Handbrake-on/low brake fluid level and low fuel level warning lights • Service interval monitor • Seatbelt unfastened warning light for front and rear seats

Additional features	ADAM JAM	ADAM GLAM	ADAM SLAM	ADAM S	ADAM ENERGISED	Price (£) exc. VAT	Total (£) inc. VAT
City mode button providing lighter steering at parking speeds	●	●	●		●		
Winter Pack ² • Electrically heated front seats • Electrically heated leather-covered steering wheel	○	○	○	○ ³		179.17	215.00

● = Standard equipment. ○ = Optional at extra cost.

¹ = Information shown in the following order: instantaneous fuel consumption, average fuel consumption, range remaining, outside temperature. ² = Fitted at no extra cost in conjunction with optional leather seat facings. ³ = Not available in conjunction with Black Track Cloth/Morrocana Recaro sports front seats.

ADAM FEATURES/OPTIONS

HEATING AND VENTILATION

Standard features • Interior pollen filter • Air recirculation with activation light • Air blend heater

	ADAM JAM	ADAM GLAM	ADAM SLAM	ADAM S	ADAM ENERGISED	Price (£) exc. VAT	Total (£) inc. VAT
Additional features							
Air conditioning with four-speed fan	●				●		
Electronic climate control incorporating air conditioning with six-speed fan		●	●	●			

INTERIOR FEATURES

Standard features • Driver's and front passenger's seats with reach and rake adjustment • Driver's seat height adjuster • 12-volt auxiliary power socket within centre console • Two drinks holders in rear centre console • Chrome-effect interior door handles • Colour-keyed fleece velour carpet • Front door pockets • Front assist handles • Fully carpeted and illuminated luggage area • Twin sunvisors incorporating driver's vanity mirror with cover • Courtesy lighting operated by door switches • 50/50 split-folding rear seat back

	ADAM JAM	ADAM GLAM	ADAM SLAM	ADAM S	ADAM ENERGISED	Price (£) exc. VAT	Total (£) inc. VAT
Additional features							
Drinks holder in front centre console with adjustable restraining strap		●	●	●			
Electro-chromatic anti-dazzle rear-view mirror	□	□	□	□			
Japan Black facia and door panel inserts	● ⁴	●	● ⁵	N/C		No-cost option	
Facia and door panel inserts matched to exterior colour	● ⁶		● ⁶		●		
Pearl White facia and door panel inserts	● ⁷						
Black Cloth interior	●	●					
Black Cloth/Morrocana interior		○	●	●	●	291.67	350.00
Leather seat facings, electrically heated front seats, electrically heated leather-covered three-spoke steering wheel and front passenger's seat height adjuster			○			583.33	700.00
Recaro sports front seats, Black Track Cloth/Morrocana trim and front passenger's seat height adjuster				○ ⁸		866.67	1040.00
Recaro sports front seats, Black Nappa Leather seat facings, electrically heated front seats, electrically heated three-spoke leather-covered steering wheel and front passenger's seat height adjuster				○		1341.67	1610.00
Electrically heated front seats	□	□	□	□			
Map pocket on front seat backs			●	●			
Sports pedals				●	●		

MECHANICAL FEATURES

	ADAM JAM	ADAM GLAM	ADAM SLAM	ADAM S	ADAM ENERGISED	Price (£) exc. VAT	Total (£) inc. VAT
Features							
Speed-sensitive power-assisted steering	●	●	●	●	●		
Sports suspension	○ ⁹	○ ⁹	●	●	●		
Five-speed manual gearbox (excluding 1.0i 115PS Turbo/1.4i 150PS Turbo models)	●	●	●	●	●		
Six-speed manual gearbox (1.0i 115PS Turbo/1.4i 150PS Turbo models only)			●	●			
Easytronic five-speed transmission with sequential manual gearshift or automatic mode (1.4i 87PS models only)		▲					

● = Standard equipment. ○ = Optional at extra cost. ▲ = See price pages for details. □ = Available as part of an option pack. N/C = No-cost option.

⁴ = Standard on I'll be Black models. Not available with other exterior colours. ⁵ = Standard on Saturday White Fever, I'll be Black, Forget about Grey, The Greyfather and Pump up the Blue models. Not available with other exterior colours. ⁶ = Standard on Red 'n' Roll, James Blonde and (on ADAM SLAM) Let it Blue models. Not available with other exterior colours. ⁷ = Standard on Saturday White Fever, Forget about Grey and The Greyfather models. Not available with other exterior colours. ⁸ = Not available in conjunction with Winter Pack. ⁹ = Fitted in conjunction with optional 17-inch wheels, not available separately.

ADAM FEATURES/OPTIONS

EXTERIOR FEATURES

Standard features • Tinted glass • Heated rear window with automatic timed cut-off • Rear window wash/wipe • Electrically operated front windows with safety autoreverse and one-touch facility
 • Electrically adjustable/heated door mirrors • Black B-pillars • Lights-on audible warning • Welcome lighting • Twin gas-assisted tailgate struts

	ADAM JAM	ADAM GLAM	ADAM SLAM	ADAM S	ADAM ENERGISED	Price (£) exc. VAT	Total (£) inc. VAT
Additional features							
Body-colour door handles	●		●	●	●		
Body-colour door handles with chrome-effect insert	□	●					
Body-colour door mirrors	●	●	N/C	N/C			No-cost option
Body-colour roof	●	●	N/C	N/C			No-cost option
Rear roof spoiler			□				
Unique ADAM S rear roof spoiler				●			
I'll be Black Roof Colour Pack • I'll be Black roof and door mirrors • Dark-tinted rear windows	□	○	●	●	●	245.83	295.00
White my Fire Roof Colour Pack • White my Fire roof and door mirrors • Dark-tinted rear windows	□	○	N/C	N/C		245.83	295.00
Let it Blue Roof Colour Pack • Let it Blue roof and door mirrors • Dark-tinted rear windows				N/C			No-cost option
Forget about Grey Roof Colour Pack • Forget about Grey roof and door mirrors • Dark-tinted rear windows			N/C	N/C			No-cost option
Red 'n' Roll Roof Colour Pack • Red 'n' Roll roof and door mirrors • Dark-tinted rear windows				N/C			No-cost option
Style Pack • Choice of White my Fire or I'll be Black Roof Colour Pack • 17-inch Technical Grey Roulette alloy wheels	○	○				579.17	695.00
Extreme Carbon Pack • Carbon fibre-effect door mirrors, front grille bar and rear-view mirror			○			166.67	200.00
Extreme Carbon Pack • Carbon fibre-effect door mirrors, front grille bar and rear-view mirror • Carbon fibre-effect inserts on lower front and rear bumpers				○		229.17	275.00
High-gloss black front grille bar					●		
Chrome-effect upper side window mouldings	□	●	●	●			
Chrome-effect door sill covers	□	●	●	●			
Sight and Light Pack One ¹⁰ • Rain-sensitive windscreen wipers • Automatic lighting control with tunnel detection • Electro-chromatic anti-dazzle rear-view mirror	○	○	○	○		191.67	230.00
Sight and Light Pack Two ¹¹ • Rain-sensitive windscreen wipers • Automatic lighting control with tunnel detection			○	○		166.67	200.00
Daytime running lights	●						
LED daytime running lights and LED tail lights	□	●	●	●	●		
Urban Pack • Chrome-effect upper side window mouldings • Chrome-effect door sill covers • Chrome-effect inserts on exterior door handles • LED daytime running lights and tail lights • Multi-colour illumination (eight colours) of centre console, door trim and footwells • Twin sunvisors incorporating illuminated driver's and front passenger's vanity mirrors with covers	○					333.33	400.00
Fixed glass roof panel with sliding blind		●					
Rear parking distance sensors	○	○	○	○		229.17	275.00
Technical Pack • R4.0 IntelliLink • Rear parking distance sensors	○ ¹²	○	○	○		412.50	495.00
Dark-tinted rear windows	□	□	●	●	●		
VXR Styling Pack ¹³ • Body-colour front lower spoiler/side sills/rear lower skirt/rear roof spoiler			○	●		625.00	750.00
Chrome-effect exhaust tailpipe extension				●			
Brilliant paint	○	○	○	○	N/C	229.17	275.00
Two-coat metallic/pearlescent paint	○	○	○	○	N/C	454.17	545.00

● = Standard equipment. ○ = Optional at extra cost. □ = Available as part of an option pack. N/C = No-cost option.

10 = Not available in conjunction with optional Extreme Carbon Pack. 11 = Only available in conjunction with optional Extreme Carbon Pack. 12 = ADAM JAM models do not feature digital radio. 13 = Not available on 1.2i 70PS models. ADAM S models feature a unique rear roof spoiler.

ADAM FEATURES/OPTIONS

AUDIO, COMMUNICATION AND NAVIGATION

Features	ADAM JAM	ADAM GLAM	ADAM SLAM	ADAM S	ADAM ENERGISED	Price (£) exc. VAT	Total (£) inc. VAT
CD/MP3 CD player/stereo radio • CD/MP3 CD player • USB connection with iPod control • Aux-in socket • AM/FM stereo radio with 36 station presets • RDS with Traffic Programme • 20 watts per channel output	●	●	●	●			
R4.0 IntelliLink touch-screen infotainment system – For use with MP3 players, USB memory sticks, mobile phones and smartphone apps Onboard features: • 7-inch colour touch-screen • AM/FM stereo radio with 36 station presets • RDS with Traffic Programme Media connections: • USB connection with iPod control • Aux-in socket • Bluetooth® A2DP audio streaming (Advanced Audio Distribution Profile) Mobile phone portal: • Bluetooth® connectivity • Handsfree calls via steering wheel controls • Vehicle microphone • Phone book access – Contacts/last calls/missed calls etc. are mirrored on IntelliLink's display and are easily navigated using the touch-screen (features dependent on mobile phone) Smartphone interface: • Apple Car Play	□	□	□	□	●		
Digital radio		●	●	●	●		
Number of speakers	4*	6	6	6	4		
Bluetooth® mobile phone portal	●	●	●	●	●		
Music streaming via Bluetooth®	●	●	●	●	●		
Vauxhall OnStar ¹⁴			●	●			
Steering wheel mounted audio controls	●	●	●	●	●		

● = Standard equipment. □ = Available as part of an option pack.

* = 6 speakers are fitted when optional Technical Pack or rear parking distance sensors are specified. 14 = Includes 12 months of OnStar services and Wi-Fi from date of first registration. A second year of OnStar services, including roadside assistance, but excluding Wi-Fi is available for £79. Does not include destination download feature. Theft alert feature only operates if optional security alarm system is specified.

Vauxhall OnStar

Once only the preserve of premium brands, our people-friendly personal connectivity and service assistant is now available across the Vauxhall car range. Vauxhall OnStar is a new, one-of-a-kind system that gives you in-car access to a host of innovations at the touch of a button. 24/7, 365 days a year you are connected to a qualified advisor – not to a machine. In the event of a crash, OnStar even automatically calls for help. Vauxhall OnStar also transforms your Vauxhall into a Wi-Fi Hotspot and turns your smartphone into a remote control for your car**.

Find out more about the full range of OnStar services at www.vauxhall.co.uk/onstar.html
Vauxhall OnStar – Your personal connectivity and service assistant.

** Some features may not be available in your region, for your carline, or trim level. Please check www.vauxhall.co.uk/onstar.html for a current overview of potential restrictions.

DIGITAL RADIO

Now widely available in the UK, digital radio broadcasts offer the user a variety of advantages over traditional FM, starting with the digital quality sound which is immune to any hiss or crackle.

You'll often find a broader range of stations on offer too, many of which are not available on FM, and listening to them couldn't be easier – you simply select the station, by name, from the displayed list, thus removing the need to retune or look for stations when travelling around. Some stations will even display the artists' names and song titles on the car's graphic display, while they're played.

INTELLILINK

IntelliLink is Vauxhall's next-generation in-car infotainment system. It features a 7-inch colour touch-screen that enables access to, and operation of, a wide range of functions including music, video, phone, navigation and internet services.

The system isn't equipped with a CD or DVD player. Instead, it's designed to support the latest media sources including Bluetooth® and USB devices, together with smartphones and their applications. All of these features are accessed through the touch-screen's Home menu.

Since many of these features are accessed via smartphone, the IntelliLink unit is designed to allow application updates as and when they become available, thus enabling it to make use of the latest smartphone developments as they happen.







Music can be played either through the radio or from personal music players via USB connection, aux-in or Bluetooth® audio streaming. When played via USB, IntelliLink's built-in Gracenote® link provides song information and album artwork. Films and slide shows can also be viewed via the USB connection, but this facility is disabled when the car is moving.

IntelliLink is able to pair with up to four Bluetooth® phones simultaneously, with each phone's address book downloaded to the audio unit so that the car effectively becomes the phone. Phone priority can then be set through the touch-screen display.

The smartphone link works in conjunction with Apple CarPlay (including Siri Eyes Free), giving access to satellite navigation and a wide range of internet radio stations.

ADAM FEATURES/OPTIONS

WHEELS AND TYRES

<i>Features</i>		ADAM JAM	ADAM GLAM	ADAM SLAM	ADAM S	ADAM ENERGISED	Price (£) exc. VAT	Total (£) inc. VAT
Emergency spare wheel (in lieu of emergency tyre inflation kit)		○	○	○			79.17	95.00
	16-inch Titan Triple Cross alloy wheels • 195/55 R 16 tyres Emergency tyre inflation kit (in lieu of spare wheel)	●						
	16-inch Silver Vintage alloy wheels • 195/55 R 16 tyres Emergency tyre inflation kit (in lieu of spare wheel)		●					
	17-inch Manooagian Hurricane alloy wheels • 215/45 R 17 tyres Emergency tyre inflation kit (in lieu of spare wheel)			●				
	17-inch I'll be Black Hurricane alloy wheels • 215/45 R 17 tyres Emergency tyre inflation kit (in lieu of spare wheel)			N/C		●	No-cost option	
	17-inch Technical Grey Roulette alloy wheels • 215/45 R 17 tyres Emergency tyre inflation kit (in lieu of spare wheel)	□	○				333.33	400.00
	18-inch Silver Turbine alloy wheels • 225/35 R 18 tyres Emergency tyre inflation kit (in lieu of spare wheel)			○			666.67	800.00
	18-inch Technical Grey Propellor diamond-cut alloy wheels • 225/35 R 18 tyres Emergency tyre inflation kit (in lieu of spare wheel)				●			

● = Standard equipment. ○ = Optional at extra cost. □ = Available as part of an option pack. N/C = No-cost option.

ADAM SPECIFICATIONS

PETROL ENGINES

	1.2i 70PS ECOTEC-4	1.4i 87PS ECOTEC-4	1.4i 100PS ECOTEC-4
Capacity	1229cc	1398cc	1398cc
Maximum power	70PS (51kW) @ 5600rpm	87PS (64kW) @ 6000rpm	100PS (74kW) @ 6000rpm
Maximum torque	115Nm (85 lb.ft.) @ 4000rpm	130Nm (96 lb.ft.) @ 4000rpm	130Nm (96 lb.ft.) @ 4000rpm
Configuration	4 cylinders, 4 valves per cylinder, double overhead camshafts	4 cylinders, 4 valves per cylinder, double overhead camshafts	4 cylinders, 4 valves per cylinder, double overhead camshafts
Fuel/induction system	Naturally aspirated. Variable Valve Timing. Multi-point sequential fuel injection	Naturally aspirated. Variable Valve Timing. Multi-point sequential fuel injection	Naturally aspirated. Variable Valve Timing. Multi-point sequential fuel injection
Emission compliance	Euro 6	Euro 6	Euro 6
Service interval	20,000 miles or 1 year (whichever occurs sooner)	20,000 miles or 1 year (whichever occurs sooner)	20,000 miles or 1 year (whichever occurs sooner)

	1.0i 115PS Turbo with Start/Stop	1.4i 150PS Turbo ECOTEC-4 with Start/Stop
Capacity	998cc	1364cc
Maximum power	115PS (85kW) @ 5200rpm	150PS (110kW) @ 4900-5500rpm
Maximum torque	170Nm (125 lb.ft.) @ 1800-4500rpm	220Nm (162 lb.ft.) @ 2750-4500rpm
Configuration	3 cylinders, 4 valves per cylinder, double overhead camshafts	4 cylinders, 4 valves per cylinder, double overhead camshafts
Fuel/induction system	Water-cooled turbocharger with intercooler. Variable Valve Timing (VVT) Central direct injection	Water-cooled turbocharger with intercooler. Variable Valve Timing (VVT) Multi-point sequential fuel injection
Emission compliance	Euro 6	Euro 6
Service interval	20,000 miles or 1 year (whichever occurs sooner)	20,000 miles or 1 year (whichever occurs sooner)

PERFORMANCE, FUEL ECONOMY AND EMISSIONS

	Wheel size (inches)	Performance (manufacturer's figures)		Fuel economy mpg (litres/100km)#			CO ₂ emissions g/km#	Vehicle Excise Duty*		Benefit in kind company car taxation rates - 2015/16 tax year
		Maximum speed (mph)	Acceleration 0-62mph (sec)	Urban driving	Extra-urban driving	Combined figure		First year rate	Standard rate	
Manual										
1.2i 70PS	16/17/18	103	14.9	39.2 (7.2)	65.7 (4.3)	53.3 (5.3)	125	£0	£110	20%
1.4i 87PS	16/17/18	109	12.5	39.8 (7.1)	62.8 (4.5)	52.3 (5.4)	125	£0	£110	20%
1.4i 100PS	17/18	115	11.5	39.8 (7.1)	62.8 (4.5)	52.3 (5.4)	125	£0	£110	20%
1.0i 115PS Turbo Start/Stop ecoFLEX	17/18	121	9.9	46.3 (6.1)	65.7 (4.3)	56.5 (5.0)	115	£0	£30	18%
1.4i 150PS Turbo Start/Stop	18	130	8.5	37.2 (7.6)	57.6 (4.9)	47.9 (5.9)	139	£130	£130	22%
Easytronic										
1.4i 87PS ecoFLEX	16/17	111	13.9	42.8 (6.6)	68.9 (4.1)	56.5 (5.0)	118	£0	£30	18%

** = Correct at time of publication.

= Official Government Test Environmental Data. Official EU-regulated test data is provided for comparison purposes and actual performance will depend on driving style, road conditions and other non-technical factors.

ADAM SPECIFICATIONS pre-2016 model year vehicles*

PERFORMANCE, FUEL ECONOMY AND EMISSIONS

	Wheel size (inches)	Performance (manufacturer's figures)		Fuel economy mpg (litres/100km)#			CO ₂ emissions g/km#	Vehicle Excise Duty**		Benefit in kind company car taxation rates – 2015/16 tax year
		Maximum speed (mph)	Acceleration 0-62mph (sec)	Urban driving	Extra-urban driving	Combined figure		First year rate	Standard rate	
Manual										
1.2i 70PS	16/17/18	103	14.9	39.2 (7.2)	65.7 (4.3)	53.3 (5.3)	125	£0	£110	20%
1.4i 87PS JAM/GLAM	16/17/18	109	12.5	39.8 (7.1)	62.8 (4.5)	52.3 (5.4)	125	£0	£110	20%
1.4i 87PS SLAM	17	109	12.5	40.9 (6.9)	64.2 (4.4)	53.3 (5.3)	125	£0	£110	20%
1.4i 87PS SLAM	18	109	12.5	40.9 (6.9)	64.2 (4.4)	52.3 (5.4)	126	£0	£110	20%
1.4i 100PS	17/18	115	11.5	39.8 (7.1)	62.8 (4.5)	52.3 (5.4)	125	£0	£110	20%
1.4i 100PS Start/Stop ecoFLEX	17/18	115	11.5	42.8 (6.6)	67.3 (4.2)	55.4 (5.1)	119	£0	£30	18%
1.0i 115PS Turbo Start/Stop ecoFLEX	16	121	9.9	46.3 (6.1)	68.9 (4.1)	57.6 (4.9)	114	£0	£30	17%
1.0i 115PS Turbo Start/Stop ecoFLEX	17/18	121	9.9	44.8 (6.3)	64.2 (4.4)	55.4 (5.1)	119	£0	£30	18%
1.4i 150PS Turbo Start/Stop	18	130	8.5	37.2 (7.6)	57.6 (4.9)	47.9 (5.9)	139	£130	£130	22%

** = Correct at time of publication.

= Official Government Test Environmental Data. Official EU-regulated test data is provided for comparison purposes and actual performance will depend on driving style, road conditions and other non-technical factors.

* = Please note that stocks are limited and that specifications may differ from those described in this Price Guide – consult your Retailer for further details.

ADAM SPECIFICATIONS

TRANSMISSION

Five-speed manual gearbox:

Standard on all models (except 1.0i 115PS Turbo/ 1.4i 150PS Turbo).

Six-speed manual gearbox:

Standard on 1.0i 115PS Turbo/ 1.4i 150PS Turbo models only.

Five-speed Easytronic transmission:

Available at extra cost on 1.4i 87PS ADAM GLAM models only. Easytronic transmission is a five-speed manual gearbox with a fully automatic mode. In manual mode you simply push the lever forward or back to shift gears up or down sequentially. The facia display tells you what gear you're in – 1 to 5.

N for Neutral or A for Auto. Switch to fully automatic mode and it has many of the features of a regular automatic including a kickdown function. There's no clutch pedal so you can drive it on an automatic-only driving licence.

STEERING

- Speed-sensitive power-assisted steering

SUSPENSION

Front: Independent. MacPherson struts with gas-pressure dampers and coil springs. Anti-roll bar.

Rear: Compound crank with coil springs and gas-pressure dampers.

BRAKING AND STABILITY

- Electronic Stability Programme – switchable on ADAM S models
- Cornering brake control
- Straight line stability control
- Anti-lock Braking System (ABS)
- Electronic brakeforce distribution
- Emergency brake assist
- Dual circuit, diagonally split braking system
- ADAM S models feature red calipers

1.2i 70PS/1.4i 87PS

Front ventilated discs: 257mm diameter

Rear drums: 203mm diameter

1.4i 100PS

Front ventilated discs: 257mm diameter

Rear drums: 228mm diameter

1.0i 115PS Turbo

Front ventilated discs: 284mm diameter

Rear discs: 264mm diameter

1.4i 150PS Turbo

Front ventilated discs: 308mm diameter

Rear discs: 264mm diameter

FUEL TANK CAPACITY

- 38 litres (8.4 gallons)

WEIGHTS kg

	Kerbweight
1.2i 70PS	1101
1.4i 87PS	1135
1.4i 100PS	1135
1.0i 115PS Turbo	1138
1.4i 150PS Turbo	1178

Kerbweight includes driver at 75kg and 90% full fuel tank.

TYRE RATING

Tyre size	Fuel efficiency group	Wet grip performance	External noise	
			Measured (dB)	Group
195/55 R 16	B-C	B	71	(A)
215/45 R 17	C	B	71	(A)
225/35 R 18	C	B	77	(A)

Tyre rating according to EU Regulation 1222/2009

EXTERIOR DIMENSIONS millimetres (inches)

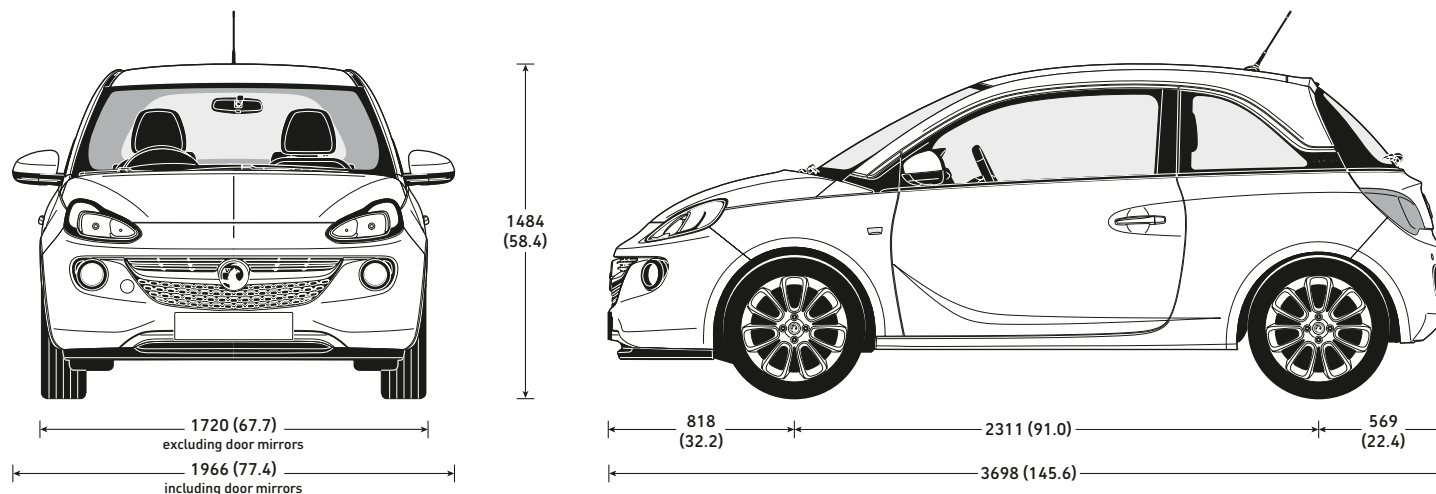

LOADSPACE DIMENSIONS

	millimetres (inches)
Maximum length (behind rear seats)	462 (18.2)
Maximum length (rear seats folded)	1041 (41.0)
Maximum width	963 (37.9)
Width between wheel arches	954 (37.6)
Maximum height	874 (34.4)

LUGGAGE CAPACITIES*

	litres (cu.ft.)
Rear seats up (under luggage compartment cover)	170 (6.0)
Rear seats folded (to upper edge of front seat back)	484 (17.1)
Rear seats folded (to roof)	663 (23.4)

* = Measured using the ECIE method.

ADAM ACCESSORIES

	Total (inc. VAT)
INFOTAINMENT	
Apple connectivity	
FlexDock cradle and baseplate	from £255.00
iPad cradle	£101.00
IntelliLink iPhone video cable	£27.00
Garmin Portable Sat Navs (includes case)	
Nüvi 42 (UK/Ireland) – 4.3-inch screen	£79.00
Nüvi 55 (UK/Ireland) – 5-inch screen, Bluetooth, eco route, lifetime traffic alerts	£89.00
Nüvi 55 (Western Europe) 5-inch screen, Bluetooth, eco route	£99.00
SAFETY	
Privacy shades – tailgate/rear side windows	£123.00
Safety Pack – first aid kit, warning triangle, hi-visibility vest, Vauxhall bag	£32.00
Parking sensors – four sensor rear bumper mounted*	
– unpainted	£320.00
– painted	£350.00
PRACTICAL	
ADAM branded literature wallet – White with Black stitching	£12.00
Flexible cupholder	£16.00
Cupholder inserts – notepad, makeup, tissue holder	£23.00
Luggage net	£23.00
Cargo box with lid – available with Splat, Fly or Stripes graphics	£158.00
Smokers Pack	£27.00
PROTECTION	
Velour floor mats	£51.00
Rubber floor mats	£41.00
Mudflaps – set of four	£110.00
Windscreen protector	£59.00
Outdoor car cover	£256.00

	Total (inc. VAT)
EXTERIOR STYLING AND FOIL KITS	
Coloured logo bar available in White My Fire, Greenspotting, Red 'n' Roll, I'll Be Black and Carbon Design	£95.00
Mirror caps (left and right hand) available in Splat, Fly and Carbon Design	£100.00
Body side mouldings	£190.00
Splat A and C Pillar area and mirrors available in White My Fire and I'll Be Black	£148.00
Stripes A Pillar and mirror available in James Blonde, I'll Be Black, Red 'n' Roll and Carbon Matt Black	£122.00
Bonnet stripes available in James Blonde, I'll Be Black, Red 'n' Roll and Carbon Matt Black	£122.00
Roof stripes available in James Blonde, I'll Be Black, Red 'n' Roll and Carbon Matt Black	£122.00
INTERIOR STYLING AND TRIM KITS	
Inside rear view mirror foils – available in Splat, Fly and Carbon Design, White My Fire, Greenspotting and Red 'n' Roll	£57.00
Sports pedals	£129.00
Painted decors available in Dark Grey, Buzz Lightgreen, Greenspotting, Pump Up The Blue, Rose Metallic, Papa Don't Peach, Tinted Steel, Pearl White, Japan Black, James Blonde and Red 'n' Roll	£176.00
Foil decors available in Bitmap, Edged Lines, Fly, Starstruck, Silver Universe and Yellow Universe	£176.00

	Total (inc. VAT)
TOURING	
Roof base carrier	£123.00
Thule bicycle carrier ¹	from £70.00
Thule roof boxes	
– Ocean 80 hard roof box (340 litres) ¹	£215.00
– Pacific 200 hard roof box (460 litres) ¹	£320.00
– Ranger 90 soft roof box (340 litres) ¹	£260.00
More available, please consult your Retailer for details.	
Flex-Fix® bicycle carrier extension – allows one additional bicycle up to 20kg	£225.00
¹ = Must be used in conjunction with a base carrier.	
ALLOY WHEELS²	
Tyre valve caps available with ADAM or Vauxhall logos – set of four	from £18.00
16-inch Greenspotting, Technical Grey and White My Fire Boomerang alloy wheels with matching centre caps	
– set of four	£705.00
17-inch Technical Grey Roulette alloy wheels with White My Fire/A Star is Brown/Sweet Greens, Copper with White My Fire, High Gloss Black and Copper	
– set of four	£865.00
18-inch Technical Grey and Manooagian Twister alloy wheels with matching centre caps	
– set of four	£1710.00
² = Different tyres and locking wheel bolts/nuts may be required at extra cost. Price excludes new tyres and locking wheel bolts/nuts, includes static wheel balancing.	

Please note:
Prices shown are a fully fitted and painted, where applicable and include VAT. Please check with your local Vauxhall Retailer for details. It is advisable to ensure your insurance policy is adequate to cover additional fitted accessories. Prices correct at time of publication.

ADAM ADDITIONAL INFORMATION

ON-THE-ROAD PRICES

To eliminate uncertainty about hidden costs when buying a new car, Vauxhall publishes on-the-road recommended retail prices (RRP) and these are shown in the pricing tables within this price guide. These prices include the recommended cost of number plates and delivery to a Vauxhall Retailer of £700.00 (including £116.67 VAT), 12 months' Government Vehicle Excise Duty (see opposite for details) and the DVLA new vehicle first registration fee of £55.00*.

Please note: The on-the-road recommended retail price (RRP) does not include fuel supplied by the Retailer, motor insurance or any other goods or services supplied by agreement between the Retailer and the customer.

PRICE PROTECTION

Order a new Vauxhall for build in the current model year (as confirmed by your Retailer) for delivery no more than three months in advance and the price you are quoted is the price you pay. This is irrespective of any subsequent price rises between placing your order and delivery of your new car, but you must take delivery as soon as the car is available. General Motors UK Limited is not liable for price adjustments caused by Government changes in the rate of VAT (currently 20%), Vehicle Excise Duty, DVLA new vehicle first registration fee or by any other applicable legislation or regulations.

VEHICLE EXCISE DUTY

The amount of Vehicle Excise Duty (road fund licence) payable on new cars varies depending on the level of carbon dioxide (CO₂) emissions produced by the vehicle. CO₂ emissions are measured in grammes (g) per kilometre (km) travelled and divided into 13 charging bands shown in the table below.

From 1 April 2010 the Government introduced a new 'first year rate' of Vehicle Excise Duty payable on all new cars. In subsequent years the amount of Vehicle Excise Duty payable will revert to the standard rate.

Vehicle Excise Duty*

	CO ₂ emissions (g/km)	First year rate	Standard rate
Band A	up to 100	£0.00	£0.00
Band B	101-110	£0.00	£20.00
Band C	111-120	£0.00	£30.00
Band D	121-130	£0.00	£110.00
Band E	131-140	£130.00	£130.00
Band F	141-150	£145.00	£145.00
Band G	151-165	£180.00	£180.00
Band H	166-175	£295.00	£205.00
Band I	176-185	£350.00	£225.00
Band J	186-200	£490.00	£265.00
Band K	201-225	£640.00	£290.00
Band L	226-255	£870.00	£490.00
Band M	over 255	£1100.00	£505.00

* = Correct at time of issue.

E10 FUEL

E10 fuel is cleared for use in all petrol-engined Vauxhall vehicles excluding models with the 2.2 litre petrol engine (code Z22YH) used in Vectra, Signum and Zafira models. Owners of these vehicles should continue to use regular unleaded or premium unleaded petrol.

PROTECTING THE ENVIRONMENT

Vauxhall's commitment to the environment is demonstrated by our products' many environmental awards. For even more information on Vauxhall's efforts to achieve an environmentally sustainable future, see www.vauxhall.co.uk/recycling

VAUXHALL ASSISTANCE

Vauxhall Assistance is provided automatically with every new Vauxhall for 12 months from first registration and covers everything from accident assistance, roadside recovery and 'at home' service to flat tyres. With Vauxhall Assistance help is literally just a free** phone call away, 24 hours a day, 365 days a year!

** = Mobile phone users will be charged at their standard tariff.

VAUXHALL LEASING

As Vauxhall's own contract hire and fleet management operation, Vauxhall Leasing provides a one-stop-shop for competitive car and van leasing solutions – for business users and private individuals. Working with the Vauxhall Retailer network, we combine the support of a national contract with the convenience of a local contact.

For further information, please see your local Vauxhall Retailer or call us on **0870 737 2557**. Alternatively, you can visit our website at www.vauxhall-leasing.co.uk

IN THE EVENT OF AN ACCIDENT...

Vauxhall Accident Support helps keep you mobile following an accident. Benefits include scene-of-accident advice, message service, assistance with claims and vehicle recovery. For further details call **0800 010 304**.

Alternatively, details can be found on our website at www.vauxhall.co.uk

VAUXHALL SERVICE PLAN

Vauxhall Retailers offer a great service for owners of all Vauxhall cars. Value for money, regular offers and free check-ups, combined with the peace of mind that comes from using Vauxhall-trained technicians and genuine parts, help keep your car in peak condition at all times.

FOR MORE PRODUCT INFORMATION

For a brochure on any Vauxhall model (up to a maximum of three per caller) or location of your nearest Vauxhall Retailer please call **0345 600 1500**. Alternatively, details can be found on our website at www.vauxhall.co.uk

VAUXHALL INSURANCE WITH ADDED REASSURANCE

Comprehensive cover – Summary of benefits*

- Competitive premiums
- Repairs by a Vauxhall-trained technician
- Genuine Vauxhall parts, guaranteed for three years when we repair your car within our Approved Repairer Network
- Free courtesy car as standard when using an Approved Repairer**
- 24 hour claims helpline
- Personal Accident benefit
- Cover for audio equipment
- Windscreen cover

Call for a quote on **0844 463 2670†**

*The benefits listed above are for comprehensive cover only. For details of Third Party, Fire and Theft cover, please call our sales team.
**Should your car need repairing following an accident we provide a courtesy car (subject to availability) for the duration of the repair. Only genuine Vauxhall parts are used. Terms and conditions apply.
†Calls may be recorded. Vauxhall Motor Insurance is underwritten by Ageas Insurance Limited.

Every effort has been made to ensure that the contents of this document were accurate and up-to-date at the time of publication – 3 December 2015 (Amended 16 December 2015). The invoice price, including delivery to Retailer, factory-fitted options, accessories fitted by the Retailer and number plates, is subject to VAT. The right is reserved to alter specifications and prices, and withdraw products from sale, without notice. Please note that Vauxhall Retailers are not the agents of General Motors UK Limited t/a Vauxhall and are not authorised to bind General Motors UK Limited by any specific or implied undertaking or representation. It is advisable to ensure that your motor insurance policy provides adequate cover for additional fitted options and accessories. All rights reserved. No part of this publication may be reproduced in any form or by any means, without the prior written permission of General Motors UK Limited.

Base information prepared by Graymatter. General Motors UK Limited, Luton LU1 3YT www.vauxhall.co.uk

©2015 General Motors UK Limited



VAUXHALL