

VAUXHALL Ampera

**Owner's Manual
Model Year 2012
Edition: September 2011
TS 1710-B-12**

Contents

Introduction	2
In brief	6
Keys, doors and windows	19
Seats, restraints	32
Storage	49
Instruments and controls	54
Lighting	90
Climate control	95
Driving and operating	101
Vehicle care	135
Service and maintenance	176
Technical data	179
Customer information	186
Index	190

Introduction

Fuel	Designation	<input type="text"/>		
Engine oil	Grade	<input type="text"/>		
	Viscosity	<input type="text"/>		
Tyre pressure	Tyre size		Front	Rear
	Summer tyres	<input type="text"/>	<input type="text"/>	<input type="text"/>
	Winter tyres	<input type="text"/>	<input type="text"/>	<input type="text"/>
Weights	Gross vehicle weight rating	<input type="text"/>		
	- Kerb weight, basic model	<input type="text"/>		
	= Loading	<input type="text"/>		

Vehicle specific data

Please enter your vehicle's data on the previous page to keep it easily accessible. This information is available in the sections "Service and maintenance" and "Technical data" as well as on the identification plate.

Introduction

Your vehicle is a designed combination of advanced technology, safety, environmental friendliness and economy.

This Owner's Manual provides you with all the necessary information to enable you to drive your vehicle safely and efficiently.

Please regard that just well trained technicians who are aware of the manufacturer's instructions, are allowed to repair and/or to work with high voltage components.

Make sure your passengers are aware of the possible risk of accident and injury which may result from improper use of the vehicle.

You must always comply with the specific laws and regulations of the country that you are in. These laws may differ from the information in this Owner's Manual.

When this Owner's Manual refers to a workshop visit, we recommend your Vauxhall Authorised Repairer.

All Vauxhall Authorised Repairers provide first-class service at reasonable prices. Experienced mechanics trained by Vauxhall work according to specific Vauxhall instructions.

The customer literature pack should always be kept ready to hand in the vehicle.

Using this manual

- This manual describes all options and features available for this model. **Certain descriptions, including those for display and menu functions, may not apply to your vehicle due to model variant, country specifications, special equipment or accessories.**

- The "In brief" section will give you an initial overview.
- The table of contents at the beginning of this manual and within each section shows where the information is located.
- The index will enable you to search for specific information.
- This Owner's Manual depicts left-hand drive vehicles. Operation is similar for right-hand drive vehicles.
- The Owner's Manual uses the factory engine designations. The corresponding sales designations can be found in the section "Technical data".
- Directional data, e.g. left or right, or front or back, always relate to the direction of travel.
- The vehicle display screens may not support your specific language.
- Display messages and interior labelling are written in **bold** letters.

Danger, Warnings and Cautions

Danger

Text marked ** Danger** provides information on risk of fatal injury. Disregarding this information may endanger life.

Warning

Text marked ** Warning** provides information on risk of accident or injury. Disregarding this information may lead to injury.

Caution

Text marked **Caution** provides information on possible damage to the vehicle. Disregarding this information may lead to vehicle damage.

Symbols

Page references are indicated with ⇨.
⇨ means "see page".

Thank you for choosing a Vauxhall.

We wish you many hours of pleasurable driving.

Your Vauxhall Team

In brief

Initial drive information

Vehicle unlocking

Radio remote control



Press button  to unlock the doors and load compartment. Open the doors by pulling the handles. To open the tailgate, press the button under the tailgate moulding.

Radio remote control ⇨ 20, Central locking system ⇨ 23, Load compartment ⇨ 25.

Open&Start



With the radio remote control within the opening range, simply press the lock/unlock button on the door handle to unlock the driver's door.

To open the tailgate, press the button under the moulding.

Open&Start system ⇨ 22.

Seat adjustment

Seat positioning

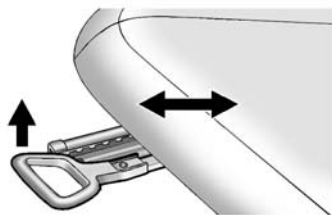

Pull handle, slide seat, release handle.

Seat position ⇨ 33, Seat adjustment ⇨ 34.

⚠ Danger

Do not sit nearer than 25 cm from the steering wheel, to permit safe airbag deployment.

Seat backrests

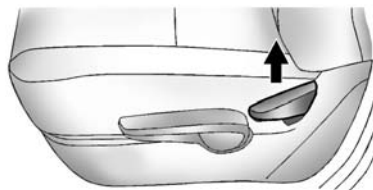

Pull lever, adjust inclination and release lever. Allow the seat to engage audibly.

Seat position ⇨ 33, Seat adjustment ⇨ 34.

Seat height

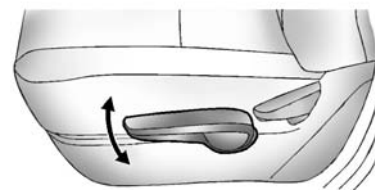

Lever pumping motion:

up = seat higher

down = seat lower

Seat position ⇨ 33, Seat adjustment ⇨ 34.

Head restraint adjustment

Height adjustment

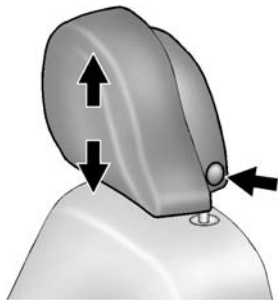

Press the button, adjust height and engage.

Head restraints ⇨ 32.

Inclination adjustment

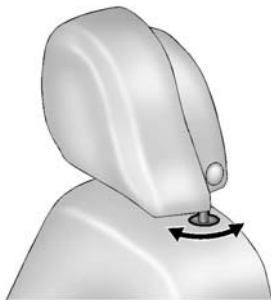

To adjust horizontally, pull the head restraint forwards. It engages in several positions.

To return to its rearmost position, pull fully forwards and release.

Head restraints ⇨ 32.

Seat belt



Pull out the seat belt and engage in belt buckle. The seat belt must not be twisted and must fit close against the body. The backrest must not be tilted back too far (maximum approx. 25 °).

To release belt, press red button on belt buckle.

Seat position ⇨ 33, Seat belts ⇨ 36, Airbag system ⇨ 40.

Mirror adjustment

Interior mirror

Dazzle from following vehicles at night is automatically reduced.

Automatic anti-dazzle interior mirror

↪ 29.

Exterior mirrors



Select the relevant exterior mirror and adjust.

Convex exterior mirrors ↪ 28,
Electric adjustment ↪ 28, Folding
exterior mirrors ↪ 29, Heated
exterior mirrors ↪ 29.

Steering wheel adjustment

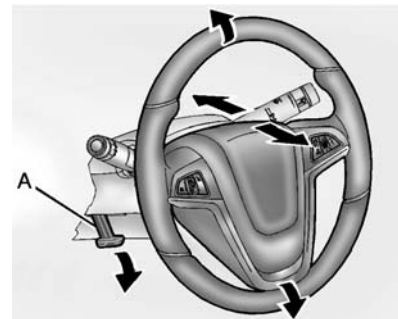

Unlock lever **(A)**, adjust steering wheel, then engage lever and ensure it is fully locked.

Do not adjust steering wheel unless vehicle is stationary and steering wheel lock has been released.

Airbag system ↪ 40.

Instrument panel overview

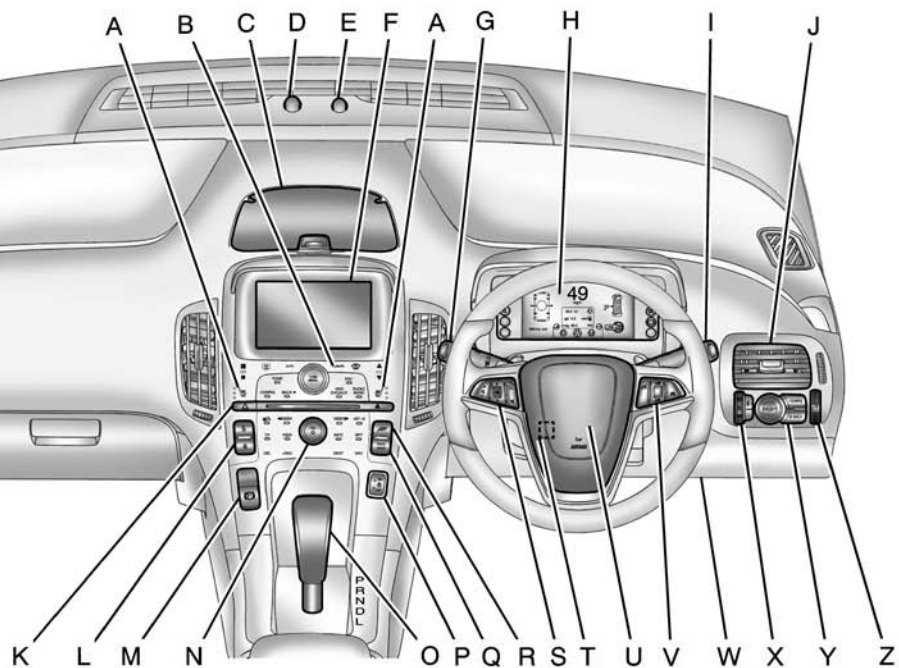

A	Heated front seats	35
B	Automatic climate control	95
C	Instrument panel storage	49
D	Charge status indicator	127
E	Daytime running light	90
F	Colour-Info-Display	69
G	Turn and lane-change signals	92
	Light switch	90
	Pedestrian safety alert	55
H	Instrument cluster display	68
	Driver Information Centre (DIC)	67
I	Windscreen wiper washer	55
J	Air vents	100
K	Hazard warning flashers	91
L	Central locking buttons	23
M	Electric parking brake	114
O	Shift lever	111
P	Power button	102
Q	Drive mode button	107
R	Leaf button	69
S	Cruise control	118
T	Steering wheel adjustment ...	54
U	Horn	55
V	Steering wheel controls	54
W	Data link connector	62
X	Headlight range adjustment ..	91
Y	Driver Information Centre (DIC)	67
Z	Instrument panel illumination control	93

N = Infotainment system
See infotainment system
manual.

Exterior lighting

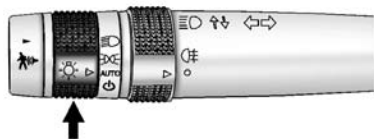

Turn adjuster wheel:

- AUTO** = automatic light control:
Exterior lighting is switched on and off automatically depending on external lighting conditions.
- ☉ = exterior lighting is switched off.
- ☉☉ = sidelights
- ☉☉☉ = headlights

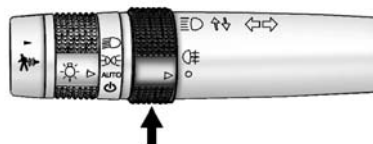

☉☉☉ = Turn the rear fog lamp band on the lever to ☉☉☉ and release it, to turn the rear fog lamp on or off. The band will return to its original position. The rear fog lamp is automatically set to off each time the ignition is turned on.

Head- and sidelights must be on for the rear fog lamp to work.

Lighting ⇨ 90.

Headlight flash, high beam and low beam

- headlight flash = pull lever
high beam = push lever
low beam = push or pull lever

Automatic light control ⇨ 90, High beam ⇨ 91, Headlight flash ⇨ 91.

Turn and lane-change signals

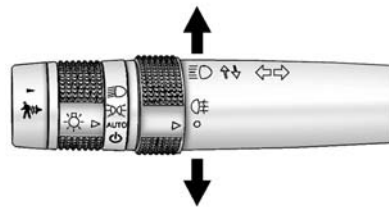

- lever up = right turn signal
lever down = left turn signal

Turn and lane-change signals ⇨ 92, Parking lights ⇨ 92.

Hazard warning flashers

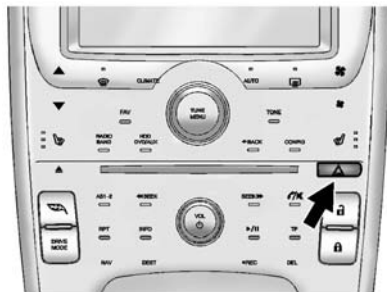

Operated with the  button.
Hazard warning flashers ⇨ 91.

Horn

Press .
Horn ⇨ 55.

Pedestrian safety alert

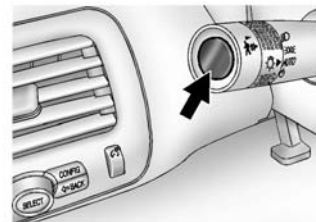

Use this feature to alert people who may not hear your vehicle approaching.

Momentarily push  on the end of the turn and lane-change lever and a soft-note alert will momentarily sound.

Repeat for additional activations of the pedestrian safety alert.

Pedestrian safety alert ⇨ 55.

Washer and wiper systems

Windscreen wiper



2 = fast

1 = slow

= interval wiper

○ = Off

For a single wipe, press the lever down to . For several wipes, hold the lever down.

Do not use if the windscreen is frozen.
Switch off in car washes.

Windscreen wiper ↷ 55, Wiper blade replacement ↷ 142.

Adjustable wiper interval

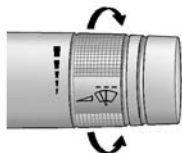

Wiper lever in position .

Turn the adjuster wheel to adjust the desired wipe interval:

short interval = turn adjuster wheel upwards
long interval = turn adjuster wheel downwards

Windscreen washer

Pull lever. Washer fluid is sprayed onto the windscreen and the wiper wipes a few times.

Windscreen washer system ↷ 55,
Washer fluid ↷ 140.

Climate control

Heated rear window, heated exterior mirrors



Heating is operated by pressing the button (F).

Heated rear window ↷ 31.

Heated rearview mirror ↷ 29.

Auto defog

The system monitors high humidity inside the vehicle. When detected, the system may adjust to outside air supply and turn on the air conditioning or the heater. The fan speed may slightly increase to help prevent fogging. When high humidity is no longer detected, the system will return to its prior operation.

Automatic climate control system

⇒ 95.

Electric drive unit

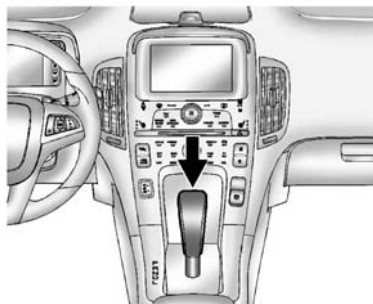

- P** = Park
- R** = Reverse
- N** = Neutral
- D** = Drive
- L** = Low

The shift lever can only be moved out of **P** when the ignition is on, the regular brake is applied first and then the shift lever button is pressed.

If you are not able to shift out of **P** (Park), ease pressure on the shift lever, then push the shift lever all the way into **P** (Park) as you maintain

brake application. Then press the shift lever button and move the shift lever into another gear.

Make sure the shift lever is fully in **P** (Park) before starting the propulsion system.

Starting off

Check before starting off

- Tyre pressure and condition ⇨ 156, ⇨ 185.
- Engine oil level and fluid levels ⇨ 138.
- All windows, mirrors, exterior lighting and number plates are free from dirt, snow and ice and are operational.
- Proper position of mirrors, seats, and seat belts ⇨ 28, ⇨ 33, ⇨ 37.
- Brake function at low speed, particularly if the brakes are wet.

Starting the vehicle

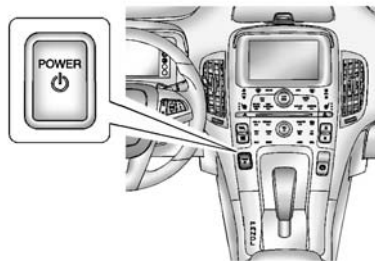

- Move the shift lever to **P** or **N**. The propulsion system will not start in any other position.
- Move the steering wheel slightly to release the steering wheel lock.
- The radio remote control must be in the vehicle. Press the brake pedal and push \odot .

Starting and stopping the vehicle
⇨ 104.

Power button ⇨ 102.

Electric vehicle operation modes

The vehicle has two modes of operation: Electric and extended range. In both modes, the vehicle is propelled by its electric drive unit.

While driving in electric or extended range mode, additional operating modes can be selected:

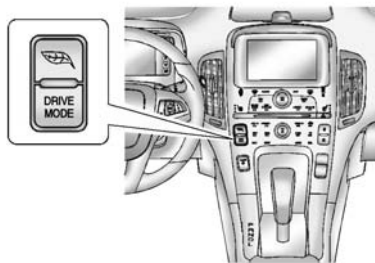

Operated with the **DRIVE MODE** button.

Press **DRIVE MODE** as long as the desired drive mode is highlighted.

Then release the **DRIVE MODE** button.

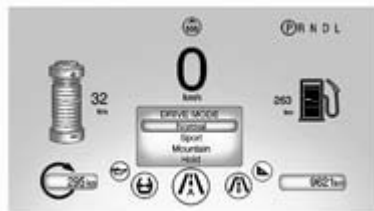

Sport: This mode provides more responsive acceleration than normal mode, but can reduce efficiency.

Mountain: This mode should be selected at the beginning of a trip before climbing steep, uphill grades and when expecting to drive in very hilly or mountainous terrain.

Mountain mode maintains a reserve electrical charge of the high voltage battery to provide better grade climbing performance. While driving in **Mountain** mode, the vehicle will have less responsive acceleration.

Hold: This mode is only available when the vehicle is in electric mode.

Hold mode places the remaining battery charge into a reserve for the driver to use as desired. Selecting this

mode transitions the vehicle to extended range mode to maintain the battery charge reserve.

Hold mode will not change normal vehicle acceleration or braking performance.

Electric vehicle operation modes
⇨ 106.

Parking

- Do not park the vehicle on an easily ignitable surface. Things that can burn could touch hot exhaust parts under the vehicle and ignite.
- Always apply the electrical parking brake. Pull switch (P).
- Switch off the ignition. Turn the steering wheel until the steering wheel lock engages.
- If the vehicle is on a level surface or uphill slope, set the parking brake and then shift the selector lever to **P**, before switching off the ignition. On an uphill slope, turn the front wheels away from the kerb.
If the vehicle is on a downhill slope, set the parking brake and then shift the selector lever to **P**, before switching off the ignition. Turn the front wheels towards the kerb.
- Lock the vehicle and activate the anti-theft alarm system.
Radio remote control ⇨ 20.
Anti-theft alarm system ⇨ 27.

Keys, doors and windows

Keys, locks

Keys

Replacement keys

The key number is specified in the Car Pass or on a detachable tag.

The key number must be quoted when ordering replacement keys as it is a component of the immobiliser system.

Locks ⇨ 173.

Lock cylinders

Designed to free-wheel if they are forcefully rotated without the correct key or if the correct key is not fully inserted. To reset, turn cylinder with the correct key until its slot is vertical, remove key and then re-insert it. If the cylinder still free-wheels, turn the key through 180° and repeat operation.

Key with foldaway key section



Press the button to extend the key.
Press the button and fold the key blade to retract the key.

Car Pass

The Car Pass contains security related vehicle data and should therefore be kept in a safe place.

When the vehicle is taken to a workshop, this vehicle data is needed in order to perform certain operations.

Radio remote control



Enables a keyless operation of the following functions:

- Central locking system ⇨ 23
- Open&Start system ⇨ 22
- Starting the vehicle ⇨ 104
- Anti-theft alarm system ⇨ 27
- Anti-theft locking system ⇨ 26
- Panic alarm
- Remote start
- Opening of the charge port door
- Comfort opening of the power windows ⇨ 29

The radio remote control has an approximate range of up to 200 feet. It can be restricted by external influences.

Handle with care, protect from moisture and high temperatures and avoid unnecessary operation.

Panic alarm

Press ⇨ once to locate the vehicle.

The exterior lights flash and the horn chirps three times.

Press ⇨ and hold for three seconds to sound the panic alarm.

The horn sounds and the turn signals flash for 30 seconds.

Press again to cancel the panic alarm.

Remote start

Activates the heating or air conditioning systems and the rear window defogger from outside the vehicle.

The auto heated seats can be programmed to come on when the vehicle is remotely started.

Vehicle personalisation ⇨ 82.

To maximise the electric range of the vehicle, use the remote start function to heat or cool the interior while the vehicle is plugged in. Normal operation of the system will return after the ignition has been switched on.

Activating

1. Press ⇨; the doors will lock.
2. Within five seconds, press and hold ⇨ until the turn signal lights flash or for approximately four seconds. Pressing ⇨ again during a remote start, will turn the feature off.

Remote start will automatically shut off after 10 minutes unless a time extension is activated.

While the remote start is active, the sidelights will turn on and remain on.

After entering the vehicle during a remote start, press the ⇨ button on the instrument panel with the brake pedal applied to operate as normal.



The remote start can be initiated two separate times between driving. For each remote start, the passenger compartment will be heated or cooled for 10 minutes.

Extending the time

To extend the time of the first remote start, repeat the steps for activating remote start. Remote start can only be extended once between driving.

Cancelling remote start

To cancel a remote start, do any of the following:

- Aim the radio remote control at the vehicle and press and hold  until the sidelights turn off.
- Turn on the hazard warning flashers.
- Press the  button on the instrument panel with the brake pedal applied, then press the  button again to switch the ignition off.

Conditions in which remote start may not work

Conditions in which a remote start may not occur include:

- An open bonnet.
- Vehicle propulsion system fault conditions, including an emission control system malfunction.
- High voltage battery fault conditions.

A second remote start or extension will not occur if the fuel level is low.

During a remote start, conditions in which a remote start may be cancelled include:

- Vehicle propulsion system or high voltage battery fault conditions.
- Low engine oil pressure.
- Engine coolant temperature that is too high.

Charge port door

Press  to open the charge port door.

Charging ⇨ 125.

Fault in the radio remote control system

In the event that it is not possible to operate the radio remote control properly, it may be due to the following:

- Range exceeded
- Battery voltage too low
- Blocked signal

If the problem persists, seek the assistance of your workshop.

Keep in mind that other conditions, such as those stated, can impact the performance of the radio remote control.

Unlocking ⇨ 23.

Radio remote control battery replacement

Note

When replacing the battery, do not touch any of the circuitry on the transmitter. Static from your body could damage the transmitter.

Replace the battery as soon as the range reduces.

To replace the battery:

1. Extend the key and open the battery cover on the back of the unit.
2. Remove the used battery. Avoid touching the circuit board to other components.
3. Replace the battery (battery type CR 2032), paying attention to the installation position.
4. Close the unit.
5. Check the operation of the radio remote control.



Batteries do not belong in household waste. They must be disposed of at an appropriate recycling collection point.

Open&Start system

Enables a keyless locking and unlocking of the doors and the tailgate without the necessity of removing the radio remote control from your pocket, purse, briefcase, etc.

Furthermore the Open&Start system enables the remote starting of the vehicle.

Starting and stopping the vehicle
↻ 104.

The radio remote control should be within three feet of the door or the tailgate being opened.

Unlocking

Driver door handle



To unlock the door from the driver's door, press the lock/unlock button on the door handle.

Press again within five seconds to unlock all passenger doors.

Passenger door handle

To unlock all doors from the passenger door, press the lock/unlock button on the door handle.

Locking

Driver door handle

To lock the doors, press the lock/unlock button on the door handle if:

- More than five seconds have passed.
- The lock/unlock button was used to unlock all doors.
- All doors are closed.

Passenger door handle

To lock the doors, press the lock/unlock button on the door handle if:

- The lock/unlock button was used to unlock all doors.
- All doors are closed.

Tailgate

If the doors are locked and the radio remote control is within range, press the button on the underside of the tailgate handle and lift up to open.

If the doors are unlocked, the radio remote control is not required to open the tailgate.

The Open&Start system can be programmed to unlock all doors on the first lock/unlock press from the driver door.

Vehicle personalisation ⇨ 82.

Central locking system

Unlocks and locks doors and the tailgate.



Note

In the event of an accident in which airbags or belt pretensioners are deployed, the vehicle is automatically unlocked.

Unlocking

Press  button.

Following settings are selectable:

- To unlock only the driver's door, press button  once.
- To unlock all doors, press button  twice within five seconds.
- To open all windows, press and hold .

The hazard warning flashers will flash twice each time the button is pressed and the anti-theft alarm system will be disarmed.

Anti-theft alarm system ⇨ 27.

Locking

Press button .

The hazard warning flashers will flash once and the anti-theft alarm system will be armed.

Anti-theft alarm system ⇨ 27.

If the driver's door is open when  is pressed, all doors lock and then the driver's door will unlock if the **Prevent doorlock while door open** feature is enabled through the vehicle personalisation.



Vehicle personalisation ⇨ 82.

By pressing  twice within five seconds with all doors closed and the ignition switched off, all doors will be locked and the anti-theft locking system will be activated.

Anti-theft locking system ⇨ 26.

Central locking buttons



Locks or unlocks all doors.
Press the  button to lock.
Press the  button to unlock.

Delayed locking

If delayed locking is enabled, a chime will sound to indicate that any door or the tailgate is open when the doors are locked with the  button on the instrument panel. The doors will automatically lock and the theft-deterrent system will arm after all doors are closed and five seconds have passed.

Press  again to lock the doors immediately.

Press  to cancel the delayed lock operation.

Vehicle personalisation ⇨ 82.

Anti-theft alarm system ⇨ 27.

Lockout protection

If the  button on the instrument panel is pressed when the driver's door is open and the ignition is on, all doors will lock and the driver's door will unlock.

This feature can also be enabled when the ignition is off.

Vehicle personalisation ⇨ 82.

Fault in the central locking system

Key

To unlock or lock the door, turn the key counterclockwise or clockwise.

Inside the vehicle

Pull up or push down on the door lock knob. Pull once on the door handle to unlock the door and a second time to open the door. Push the central locking button.

Child locks

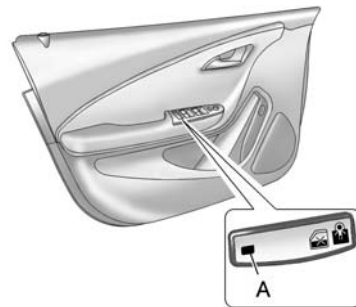

Warning

Use the child locks whenever children are occupying the rear seats.

The rear door child locks prevent passengers from opening the rear doors from inside the vehicle.

Press  to activate. The LED (A) comes on when activated.

Press  again to deactivate.

Doors

Load compartment

Tailgate

Opening

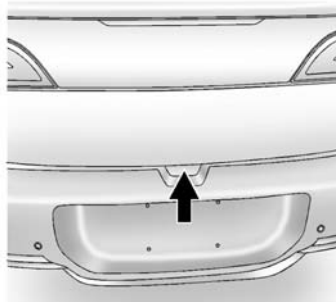

To open the tailgate with all doors unlocked, press the button on the underside of the tailgate handle and lift up.

Closing

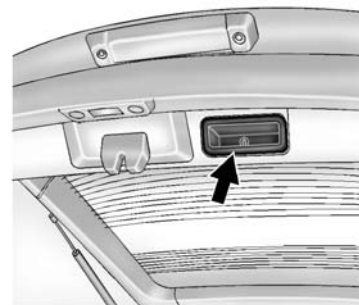

Use the inside pull handle to lower and close the tailgate.

Always close the tailgate before driving. Do not press the button while closing the tailgate; it will unlatch again.

General hints for operating tailgate

⚠ Warning

Do not drive with the tailgate open or ajar, e.g. when transporting bulky objects, since toxic exhaust gases, which can not be seen or smelled, could enter the vehicle. This can cause unconsciousness and even death.

Caution

Before opening the tailgate, check overhead obstructions, such as a garage door, to avoid damage to the tailgate. Always check the moving area above and behind the tailgate.

Note

The installation of certain heavy accessories onto the tailgate may affect its ability to remain open.

Vehicle security

Anti-theft locking system

⚠ Warning

Do not use the system if there are people in the vehicle! The doors cannot be unlocked from the inside.

The system deadlocks all the doors. All doors must be closed or the system cannot be activated.

When the doors are secured with the anti-theft locking system, it is not possible to unlock the doors with the manual door lock controls.

Additional to that, it is not possible to unlock the vehicle with the central locking buttons.

Activation

Press  on the radio remote control twice within five seconds with all doors closed and the ignition switched off.

It is also possible to activate the anti-theft locking system by pressing the lock/unlock button on the driver door handle twice within five seconds if any of the following occur:

- Five seconds after the lock/unlock button on the driver door handle has been pressed for the first time.
- Two lock/unlock button presses were used to unlock all doors.
- Any vehicle door has opened and all doors are now closed.

Deactivation

Press  on the radio remote control once to deactivate the anti-theft locking system and unlock the driver's door.



Pressing  again within three seconds will unlock all of the doors.

Anti-theft alarm system

It monitors:

- Doors, tailgate, bonnet
- Passenger compartment including adjoining load compartment
- Vehicle inclination, e.g. if it is raised
- Removing of the charge cord

Activation

- Press the  button on the radio remote control after all of the doors and windows have been closed.
- Press the  button on the instrument panel when the **Prevent doorlock while door open** function is turned off.

Vehicle personalisation ⇨ 82.

The system arms itself 30 seconds after the vehicle has been locked.



By pressing  twice, the system will bypass the 30 second delay and it will arm immediately.

Note

Changes to the vehicle interior such as the use of seat covers, and open windows or sunroof, could impair the function of passenger compartment monitoring.

Activation without monitoring of passenger compartment and vehicle inclination

Switch off the monitoring of passenger compartment and vehicle inclination when animals are being left in the vehicle, because of high volume ultrasonic signals or movements triggering the alarm. Also switch off when the vehicle is on a ferry or train.

1. With the ignition switched off, press  in the overhead console. LED in the  button comes on.
2. Close all doors, tailgate and bonnet.
3. Activate the anti-theft alarm system.

Deactivation

Unlocking or approaching the vehicle with the radio remote control, deactivates the anti-theft alarm system.

Charge cord theft alert

To activate or deactivate the charge cord theft alert while plugged in, lock or unlock the vehicle with the radio remote control.

If there is an attempt to remove the charge cord while the vehicle is locked, the system alarm will be activated. To turn off the system alarm, press  on the radio remote control.

This function can be disabled in vehicle personalisation.

Vehicle personalisation ⇨ 82.



Alarm

When triggered, the alarm sounds via a separate battery-backed power sounder for about 30 seconds and the hazard warning lights flash simultaneously.

If the vehicle loses battery power when the anti-theft alarm system is armed, the power sounder will activate automatically.

The number and duration of alarm signals are stipulated by legislation.

To turn off the system alarm:

- Press  on the radio remote control or
- Start the vehicle by pressing the  button on the instrument panel with the brake pedal applied and the radio remote control located inside the vehicle.

Immobiliser

This vehicle has a passive theft-deterrent system. The system does not have to be manually activated or deactivated.



The immobiliser is activated automatically after the ignition is switched off.

The system is automatically disarmed when the vehicle is started with a valid radio remote control located inside

the vehicle. The radio remote control uses electronic coding that matches an immobiliser control unit in the vehicle and automatically deactivates the system. Only a correct radio remote control can be used to switch the ignition on.

 comes on if there is a problem with activating or deactivating the immobiliser.

Note

The immobiliser does not lock the doors. You should always lock the vehicle after leaving it and switch on the anti-theft alarm system  23,  27.

If the vehicle does not start and the control indicator stays on, there is a problem with the system. Attempt to switch the ignition off and try it again.

Do not leave the radio remote control inside the vehicle.

Control indicator   65.

Exterior mirrors

Convex shape

The convex exterior mirror contains an aspherical area and reduces blind spots. The shape of the mirror makes objects appear smaller, which will affect the ability to estimate distances.

Electric adjustment



Select the relevant exterior mirror by moving the selector switch to left (L) or right (R). Then press the arrows on the control pad to adjust the respective mirror.

In the centre position of the selector switch no mirror is selected.

Folding

For pedestrian safety, the exterior mirrors will swing out of their normal mounting position if they are struck with sufficient force. Reposition the mirror by applying slight pressure to the mirror housing.

Heated

Operated by pressing the  button.

Turns off automatically after about five minutes.

Heated rear window ⇨ 31.

Interior mirrors

Automatic anti-dazzle

Dazzle from following vehicles at night is automatically reduced.

Windows

Power windows

Warning

Take care when operating the power windows. Risk of injury, particularly to children.

If there are children on the rear seats, switch on the child safety system for the power windows.

Keep a close watch on the windows when closing them. Ensure that nothing becomes trapped in them as they move.

Warning

Do not leave children together with the radio remote control inside the vehicle.

They could operate the windows, other controls or even move the vehicle, so that they could be seriously injured or killed.

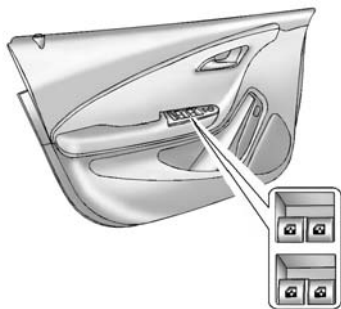

Operate the switch for the respective window by pushing to open or pulling to close.

Pushing or pulling gently to the first detent: window moves up or down as long as the switch is operated.

Pushing or pulling firmly to the second detent and then releasing: window moves up or down automatically with safety function enabled. To stop movement, operate the switch once more in the same direction.

The driver window can be lowered or raised without holding the switch.

The passenger and rear windows can just be lowered without holding the switch.

Power windows can work until the driver's door is opened or at the latest for 10 minutes after the ignition is switched off.

Safety function

If the window glass encounters resistance above the middle of the window during automatic closing, it is immediately stopped and opened again.



Override safety function

In the event of closing difficulties due to frost or the like, pull and hold the switch. The window moves up without safety function. To stop movement, release the switch.

Use care when using the override safety function.

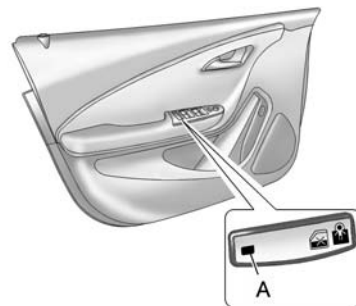
Child safety system for rear windows



Press switch   to deactivate rear door power windows; the LED (A) illuminates.

Press   again to deactivate.

Comfort opening

The windows can be opened remotely from outside the vehicle.



Press and hold  button to open windows.

Release button to stop window movement.

Overload

If the windows are repeatedly operated within short intervals, the window operation is disabled for some time.

Initialising the power windows

Initialise the power windows may be necessary if the 12 volt battery has been disconnected or discharged.

Activate the window electronics as follows:

1. Close all doors with the ignition on or when retained power off is active.
2. Pull switch until the window is closed and keep pulling for additional 2 seconds.
3. Repeat for each window.

Heated rear window

Operated by pressing the  button.

Heating turns off automatically after about five minutes.

Sun visors

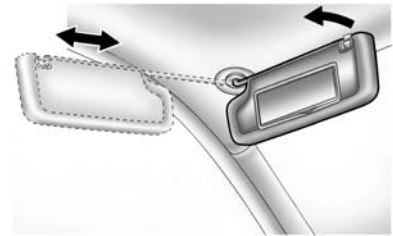

Pull the sun visor down to block glare. Detach the sun visor from the centre mount to pivot to the side window or to extend along the rod.

If the sun visors have integral mirrors, the mirror covers should be closed when driving.

Seats, restraints

Head restraints

Position

⚠ Warning

Only drive with the head restraint set to the proper position.

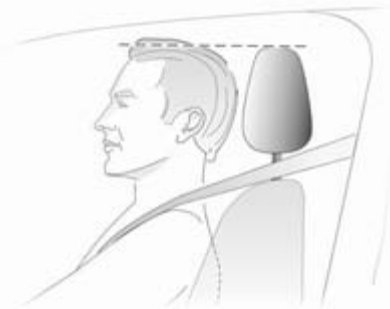

The upper edge of the head restraint should be at upper head level. If this is not possible for extremely tall people, set to highest position, and set to lowest position for small people.

Adjustment

Head restraints on front seats

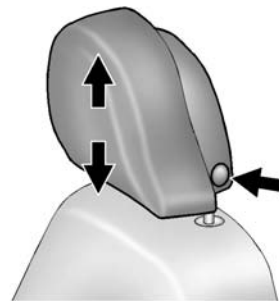

Height adjustment

Press the button, adjust height and make sure that the head restraint is engaged.

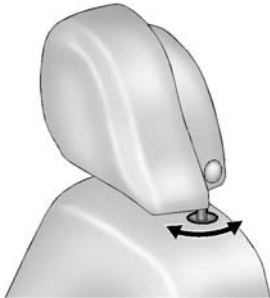

Inclination adjustment

To adjust horizontally, pull the head restraint forwards. It engages in several positions.

To return to its rearmost position, pull fully forwards and release.

Head restraints on rear seats

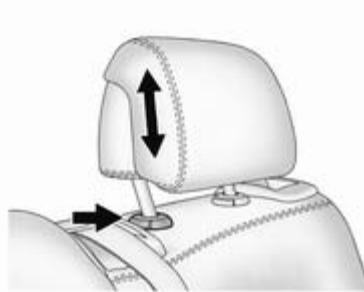

Height adjustment

Pull the head restraint upwards or press the catch to release and push the head restraint downwards.

Make sure that the head restraint is engaged.

Front seats

Seat position

Warning

Only drive with the seat correctly adjusted.



- Sit with buttocks as far back against the backrest as possible. Adjust the distance between the seat and the pedals so that legs are slightly angled when pressing the pedals. Slide the front passenger seat as far back as possible.

- Sit with shoulders as far back against the backrest as possible. Set the backrest rake so that it is possible to easily reach the steering wheel with arms slightly bent. Maintain contact between shoulders and the backrest when turning the steering wheel. Do not angle the backrest too far back. We recommend a maximum rake of approx. 25°.
- Adjust the steering wheel ⇨ 54.
- Set seat height high enough to have a clear field of vision on all sides and of all display instruments. There should be at least one hand of clearance between head and the roof frame. Your thighs should rest lightly on the seat without pressing into it.
- Adjust the head restraint ⇨ 32.

Seat adjustment

⚠ Danger

Do not sit nearer than 25 cm from the steering wheel, to permit safe airbag deployment.

⚠ Warning

Never adjust seats while driving as they could move uncontrollably.

Seat positioning

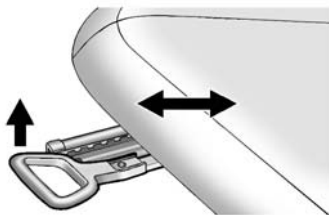

Pull handle, slide seat, release handle. Allow the backrest to engage audibly.

Seat backrests

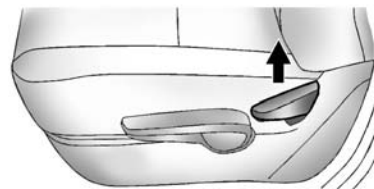

Pull lever, adjust inclination and release lever. Allow the backrest to engage audibly.

To return the seatback to the upright position, pull the lever without applying pressure to the seatback and release lever.

Seat height

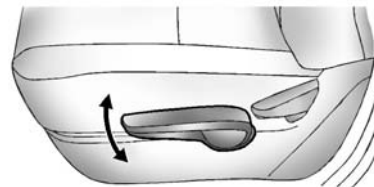

Lever pumping motion:

up = seat higher

down = seat lower

Heating

Manual heated seats

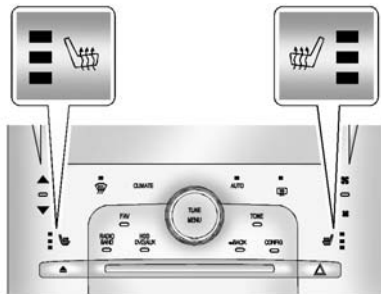

Adjust heating to the desired setting by pressing the button for the respective seat one or more times. The LEDs next to the heating symbol indicate the setting.

Prolonged use of the highest setting for people with sensitive skin is not recommended.

Auto heated seats

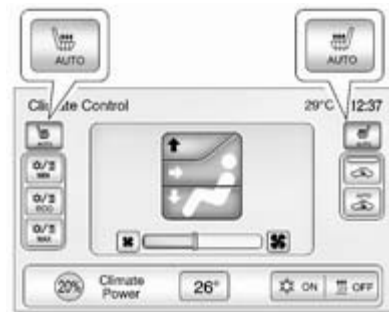

Activation

To activate auto heated seats:

1. Press the **Climate** control button on the instrument panel.
2. Press **AUTO** for the respective seat on the touch screen.

The **AUTO** button illuminates green as a confirmation of the setting.

When the ignition is switched on, the auto heated seats function will automatically activate the heated seats at the level required by the vehicle's interior temperature.

The LEDs next to the seat heating symbol on the instrument panel indicate the heat setting.

Auto heated seats can be programmed to always be enabled when the ignition is on.

Vehicle personalisation ⇨ 82.

Deactivation

To deactivate auto heated seats:

- Press **AUTO** for the respective seat on the touch screen of the Colour-Info-Display

or

- Press the button for the respective seat on the instrument panel.

If the passenger seat is unoccupied, the auto heated seat function will not activate that seat.

Remote start heated seats

When it is cold outside, the heated seats can be programmed to turn on automatically during a remote vehicle start. Unless the auto heated seats function is available and enabled, the heated seats will be cancelled when the vehicle is turned on. If the auto heated seats function is enabled, the seat heating level will automatically change to the level required by the vehicle's interior temperature when the ignition is switched on.

The LEDs next to the seat heating symbol do not turn on during a remote start.

The temperature performance of an unoccupied seat may be reduced. This is normal.

The heated seats will not turn on during a remote start unless the heated seats feature is enabled in the vehicle personalisation menu.

Vehicle personalisation ⇨ 82.

Remote start ⇨ 20.

Seat belts



The seat belts are locked during heavy acceleration or deceleration of the vehicle holding the occupants in the sitting position. Thereby the risk of injury is considerably reduced.

Warning

Fasten seat belt before each trip.

In the event of an accident, people not wearing seat belts endanger their fellow occupants and themselves.

Seat belts are designed to be used by only one person at a time. They are not suitable for people smaller than 150 cm. Child restraint system ⇨ 43.

Periodically check all parts of the belt system for damage and proper functionality.

Have damaged components replaced. After an accident, have the belts and triggered belt pretensioners replaced by a workshop.

Note

Make sure that the belts are not damaged by shoes or sharp-edged objects or trapped. Prevent dirt from getting into the belt retractors.

Seat belt reminder 🚨 ⇨ 61.

Belt force limiters

On the front seats, stress on the body is reduced by the gradual release of the belt during a collision.

Belt pretensioners

In the event of a head-on or rear-end collision of a certain severity, the front seat belts are tightened.

⚠ Warning

Incorrect handling (e.g. removal or fitting of belts) can trigger the belt pretensioners.

Deployment of the belt pretensioners is indicated by continuous illumination of control indicator  ↻ 61.

Triggered belt pretensioners must be replaced by a workshop. Belt pretensioners can only be triggered once.

Note

Do not affix or install accessories or other objects that may interfere with the operation of the belt pretensioners. Do not make any modifications to belt pretensioner components as this will invalidate the vehicle type approval.

Three-point seat belt**Fastening**

Withdraw the belt from the retractor, guide it untwisted across the body and insert the latch plate into the buckle. Tighten the lap belt regularly whilst driving by pulling the shoulder belt. Seat belt reminder ↻ 61.



Loose or bulky clothing prevents the belt from fitting snugly. Do not place objects such as handbags or mobile phones between the belt and your body.

⚠ Warning

The belt must not rest against hard or fragile objects in the pockets of your clothing.

Removing



30054

To release belt, press red button on belt buckle.

Seat belt comfort guides on the rear seats

The guides may provide added seat belt comfort for older children who have outgrown booster seats and for some adults. When installed and properly adjusted, the comfort guide positions the seat belt away from the neck and head.

There is one guide for each passenger position in the rear seat. When using a comfort guide, remove the seat belt from the seat-mounted guide before using the comfort guide. To install a comfort guide to the seat belt, proceed as follows:

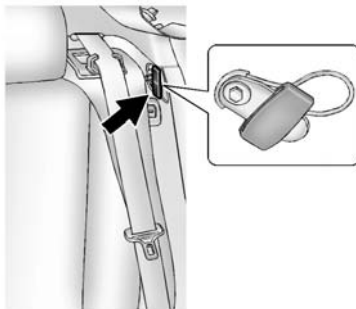

1. Remove the guide from its storage clip on the interior body trim next to the rear seat.



2. Place the guide over the belt, and insert the two edges of the seat belt into the slots of the guide.

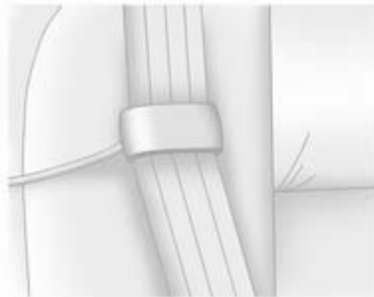

- The seat belt should not be twisted and it should lie flat. The elastic cord must be under the seat belt and the guide on top.

⚠ Warning

A seat belt that is not properly worn may not provide the protection needed in a crash. The person wearing the seat belt could be seriously injured. The shoulder belt should go over the shoulder and across the chest. These parts of the body are best able to take belt restraining forces.



- Buckle and position the seat belt as described previously in this section. Make sure that the shoulder belt crosses the shoulder.
- To remove and store the comfort guide, squeeze the seat belt edges together so that the seat belt can be removed from the guide. Slide the guide back into its storage clip located on the interior body trim next to the side of the seat backrest.

Using the seat belt while pregnant



⚠ Warning

The lap belt must be positioned as low as possible across the pelvis to prevent pressure on the abdomen.

Airbag system

The airbag system consists of a number of individual systems depending on the scope of equipment.

When triggered the airbags inflate within milliseconds. They also deflate so quickly that it is often unnoticeable during the collision.

Warning

If handled improperly the airbag systems can be triggered in an explosive manner.

Note



The airbag systems and belt pretensioner control electronics are located in the centre console area. Do not put any magnetic objects in this area.

Do not stick anything on the airbag covers and do not cover them with other materials.

Each airbag is triggered only once. Have deployed airbags replaced by a workshop. Furthermore, it might be necessary to have the steering wheel, the instrument panel, parts of the panelling, the door seals, handles and the seats replaced.

Do not make any modifications to the airbag system as this will invalidate the vehicle type approval.

When the airbags inflate, escaping hot gases may cause burns.

Control indicator  for airbag systems  61.

Front airbag system

The front airbag system consists of one airbag in the steering wheel and one in the instrument panel on the front passenger side. These can be identified by the word **AIRBAG**.

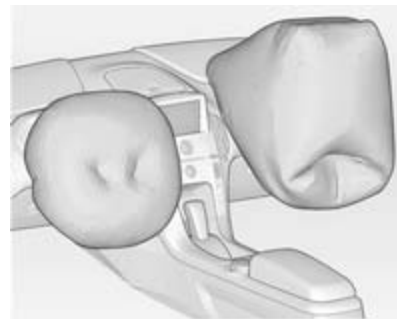

The front airbag system is triggered in the event of a front-end impact of a certain severity. The ignition needs to be switched on.

The inflated airbags cushion the impact, thereby reducing the risk of injury to the upper body and head of the front seat occupants considerably.

⚠ Warning

Optimum protection is only provided when the seat is in the proper position ⇨ 33.

Keep the area in which the airbag inflates clear of obstructions.

Fit the seat belt correctly and engage securely. Only then the airbag is able to protect.

Side airbag system

The side airbag system consists of an airbag in each side of the front seat backrests. This can be identified by the word **AIRBAG**.

The side airbag system is triggered in the event of a side impact of a certain severity. The ignition needs to be switched on.



The inflated airbags cushion the impact, thereby reducing the risk of injury to the upper body and pelvis in the event of a side-on collision considerably.

⚠ Warning

Keep the area in which the airbag inflates clear of obstructions.

Note

Only use protective seat covers that have been approved for the vehicle. Be careful not to cover the airbags.

Curtain airbag system

The curtain airbag system consists of an airbag in the roof frame on each side. This can be identified by the word **AIRBAG** along the headliner or trim.

The curtain airbag system is triggered in the event of a side-on impact of a certain severity. The ignition needs to be switched on.



The inflated airbags cushion the impact, thereby reducing the risk of injury to the head in the event of a side-on impact considerably.

⚠ Warning

Keep the area in which the airbag inflates clear of obstructions.

The hooks on the handles in the roof frame are only suitable for hanging up light articles of clothing, without coat hangers. Do not keep any items in these clothes.

Knee airbag system

The knee airbags are located below the steering column and below the glovebox.

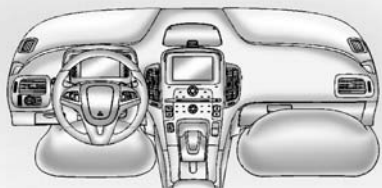

With knee airbags, the word **AIRBAG** will appear on the lower portion of the instrument panel.

The knee airbag system is triggered in the event of a front-end impact of a certain severity. The ignition needs to be switched on.

The inflated airbags cushion the impact, thereby reducing the risk of injury to the lower body of the front seat occupants considerably.

Keep the area in which the airbag inflates clear of obstructions.

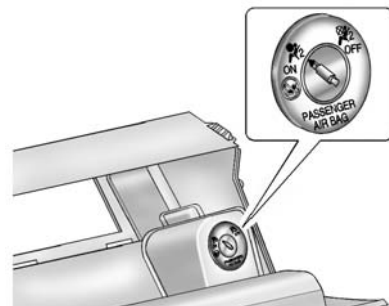

Airbag deactivation

Front airbag and knee airbag systems for the front passenger seat must be deactivated if a child restraint system is to be fitted on this seat. The curtain and side airbag systems, the belt pretensioners and all driver airbag systems will remain active.



The front passenger airbag system can be deactivated via a key-operated switch located inside the glovebox.

Use the ignition key to choose the position:

: Front passenger frontal and knee airbags are deactivated and will not inflate in the event of a collision. Control indicator  illuminates continuously. A child restraint system can be installed in accordance with the chart Child restraint installation locations ⇨ 45. No adult person is allowed to occupy the front passenger seat.

: Front passenger frontal and knee airbags are active. A child restraint system must not be installed.

Danger

Risk of fatal injury for a child using a child restraint system on a seat with activated front passenger frontal and knee airbag.

Risk of fatal injury for an adult person on a seat with deactivated front passenger frontal and knee airbag.



As long as the control indicator  is not illuminated, the airbag systems for the front passenger seat will inflate in the event of a collision.

If both control indicators are illuminated at the same time, there is a system failure. The status of the

system is not discernible, therefore no person is allowed to occupy the front passenger seat. Contact a workshop immediately.

Consult a workshop immediately if neither of the two control indicators is illuminated.

Change status only when the vehicle is stopped with the ignition off.

Status remains until the next change.

Control indicator for airbag deactivation  62.

Child restraints

Child restraint systems

We recommend the Vauxhall child restraint system which is tailored specifically to the vehicle.

When a child restraint system is being used, pay attention to the following usage and installation instructions and also those supplied with the child restraint system.

Always comply with local or national regulations. In some countries, the use of child restraint systems is forbidden on certain seats.

⚠ Danger

When using a child restraint system on the front passenger seat, the airbag systems for the front passenger seat must be deactivated; if not, the triggering of the airbags poses a risk of fatal injury to the child.

This is especially the case if rear-facing child restraint systems are used on the front passenger seat.

**Selecting the right system**

The rear seats are the most convenient location to fasten a child restraint system. Children should travel facing rearwards in the vehicle as long as possible. This makes sure that the child's backbone, which is still very weak, is under less strain in the event of an accident.

Children under the age of 12 years that are smaller than 150 cm are only allowed to travel in a restraint system that is suitable for the child. Suitable are restraint systems that comply with ECE 44-03 or ECE 44-04. Since a proper position of the belt is rarely possible with a child that is smaller than 150 cm, we strongly advise the use of an appropriate child restraint system, even though this may, due to the age of the child, no longer be legally binding.

Ensure that the child restraint system to be installed is compatible with the vehicle type.

Ensure that the mounting location of the child restraint system within the vehicle is correct.

Allow children to enter and exit the vehicle only on the side facing away from the traffic.

When the child restraint system is not in use, secure the seat with a seat belt or remove it from the vehicle.

Note

Do not stick anything on the child restraint systems and do not cover them with any other materials.

A child restraint system which has been subjected to stress in an accident must be replaced.

Child restraint installation locations

Permissible options for fitting a child restraint system

Mass group	On front passenger seat		On rear outboard seats
	activated airbag	deactivated airbag	
Group 0: Up to 10 kg	X	U ¹	U
Group 0+: Up to 13 kg	X	U ¹	U
Group I: 9 to 18 kg	X	U ¹	U
Group II: 15 to 25 kg	X	X	U
Group III: 22 to 36 kg	X	X	U

¹ = Seating position must be adjusted to full up seat height travel.

U = Suitable for universal category restraints approved for use in this mass group.

X = Seat position not suitable for children in this mass group.

Permissible options for fitting an ISOFIX child restraint system

Mass group	Size class	Fixture	On front passenger seat	On rear outboard seats
Infant car bed (carycot)	F	ISO/L1	X	X
	G	ISO/L2	X	X
Group 0: up to 10 kg	E	ISO/R1	X	IL ¹

Mass group	Size class	Fixture	On front passenger seat	On rear outboard seats
Group 0+: up to 13 kg	E	ISO/R1	X	IL ¹
	D	ISO/R2	X	IL ²
	C	ISO/R3	X	IL ³
Group I: 9 to 18 kg	D	ISO/R2	X	IL ²
	C	ISO/R3	X	IL ³
	B	ISO/F2	X	IL, IUF
	B1	ISO/F2X	X	IL, IUF
	A	ISO/F3	X	IL

IL = Suitable for particular ISOFIX restraint systems of the 'specific-vehicle', 'restricted' or 'semi-universal' categories. The ISOFIX restraint system must be approved for the specific vehicle type.

IUF = Suitable for ISOFIX forward-facing child restraint systems of universal category approved for use in this mass group.

X = ISOFIX position not suitable for ISOFIX child restraint systems in this mass group and/or the size class.

¹ = Seating position in front of ISOFIX position must be adjusted to full forward seat travel.

² = Seating position in front of ISOFIX position must be adjusted to third adjustment position rearward of full forward seat travel.

³ = Seating position in front of ISOFIX position must be adjusted to the sixth adjustment position rearward of full forward seat.

ISOFIX size class and seat device

A – ISO/F3 = Full-height forward-facing toddler child restraint system.

B – ISO/F2 = Reduced-height forward-facing toddler child restraint system.

-
- B1 – ISO/F2X = Reduced-height forward-facing toddler child restraint system.
 - C – ISO/R3 = Full-size rear-facing toddler child restraint system.
 - D – ISO/R2 = Reduced-size rear-facing toddler child restraint system.
 - E – ISO/R1 = Rear-facing infant child restraint system.
 - F – ISO/L1 = Left side-facing position carrycot.
 - G – ISO/L2 = Right side-facing position carrycot.

ISOFIX child restraint systems



Fasten vehicle-approved ISOFIX child restraint systems to the ISOFIX mounting brackets.

No more than two ISOFIX child restraint systems can be installed on the rear seats at the same time.

ISOFIX mounting brackets are indicated by a label  on the backrest.

Top-tether fastening eyes

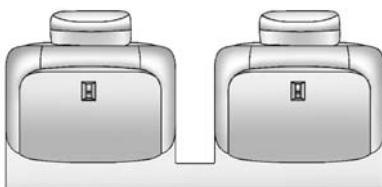

The Top-Tether anchors for outboard rear seating positions are on the back of the rear seatback. Be sure to use an anchor on the same side of the vehicle as the seating position where the child restraint will be placed.

Top-Tether fastening eyes are marked with the symbol  for a child seat.



In addition to the ISOFIX mounting, fasten the Top-Tether strap to the Top-Tether fastening eyes. The strap must run between the two guide posts of the head restraint.

Storage

Storage compartments

Instrument panel storage

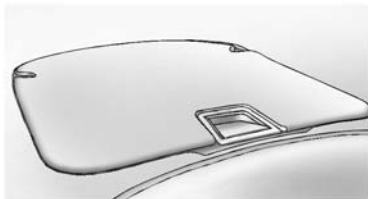

There is a storage compartment on top of the instrument panel that includes an auxiliary power outlet.

A transmitter slot for the radio remote control transmitter is located inside the storage compartment.

Radio remote control ⇨ 20.

Glovebox

Open the glove box by lifting up on the lever.

The glovebox should be closed whilst driving.

Door panel storage



Slide an umbrella into the opening either the driver or passenger door.

Floor console storage

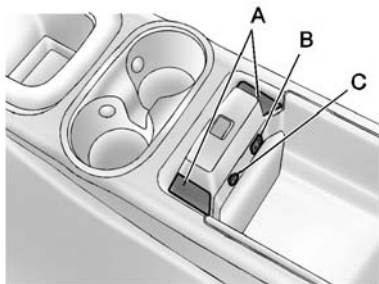

Inside the front of the floor console is an auxiliary power outlet (C) and jack for auxiliary input devices (B). Cords can be routed in the pass-through (A).

For more information, see the infotainment manual.

The console has cupholders and a storage area.

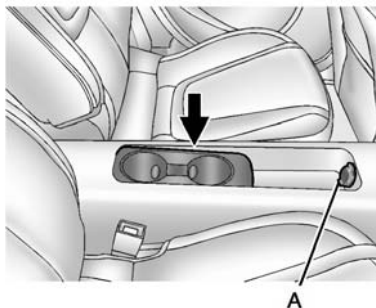

The rear console has open storage with an auxiliary power outlet (A) and cupholders.

Load compartment

Folding the seat backrests

⚠ Warning

Only drive the vehicle if the backrests are securely locked into position. Otherwise there is a risk of personal injury or damage to the load or vehicle in the event of heavy braking or a collision.

Fold seat backrests down

Note

Folding a rear seat with the seat belts still fastened may cause damage to the seat or the seat belts. Always unbuckle the seat belts and return them to their normal stowed position before folding a rear seat.

1. Remove the load compartment cover, if necessary.
2. Press and hold the catch, then push the head restraints down.

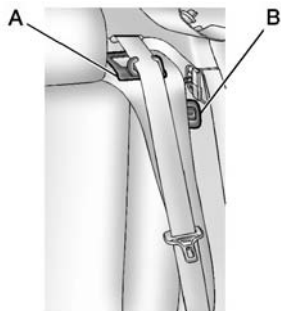

3. Remove the seat belt from the seat belt guide (A) and place it in the storage clip (B).
4. Pull the seatback release lever to unlock the seatback and fold the seatback forward.

Fold seat backrests up

Note

Damage to the seat belt or seat backrest locking mechanism can occur if the seat belt is caught between the rear seat backrest and the seat backrest locking mechanism. The seat belt must be out of the way when the rear seat is raised to the upright, locked position. If the seat belt is damaged, seek the assistance of a workshop and have it replaced.

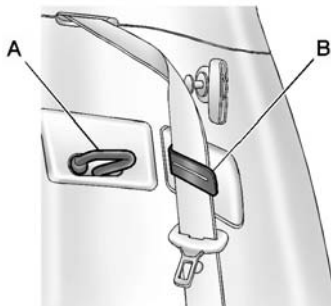

1. Make sure the seat belt is in the storage clip (B) before raising the seat backrest.

The seat belt should not cross the seat backrest locking mechanism (A) when raising the seat backrest.

2. Raise the seat backrest and push it rearward to lock it into place. Ensure that the seat backrest is audibly engaged.
3. Return the seat belt to the seat belt guide after raising the seat backrest.

Keep the seat in the upright, locked position when not in use.

Load compartment cover

Use the four loops to hook the cover to the side panels.

Do not place any objects on the cover.

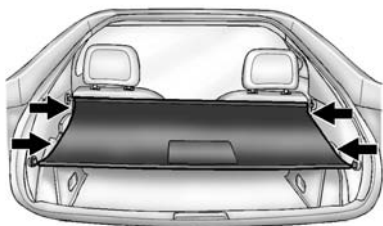

Warning triangle

The warning triangle is located in the right rear cargo storage door.

First aid kit

The first aid kit is located in the right rear cargo storage door.

Loading information

- Heavy objects in the load compartment should be placed against the seat backrests. Make sure that the backrests are securely engaged. If objects can be stacked, heavier objects should be placed at the bottom.
- Secure objects with lashing straps attached to lashing eyes.
- Secure loose objects in the load compartment to prevent from sliding.
- When transporting objects in the load compartment, the backrests of the rear seats must not be angled forward.
- Do not allow the load to protrude above the upper edge of the backrests.
- Do not place any objects on the load compartment cover or the instrument panel, and do not cover the sensor on top of the instrument panel.

- The load must not obstruct the operation of the pedals, shift lever, or hinder the freedom of movement of the driver. Do not place any unsecured objects in the interior.
- Do not drive with an open load compartment.

Warning

Always make sure that the load in the vehicle is securely stowed. Otherwise objects can be thrown around inside the vehicle and cause personal injury or damage to the load or car.

- The payload is the difference between the permitted gross vehicle weight and the EC kerb weight.
- To calculate the payload, enter the data for your vehicle in the Weights table at the front of this manual.
- The EC kerb weight includes weights for the driver (68 kg), luggage (7 kg) and all fluids (tank 90 % full).

Optional equipment and accessories increase the kerb weight.

--

Instruments and controls

Controls

Steering wheel adjustment

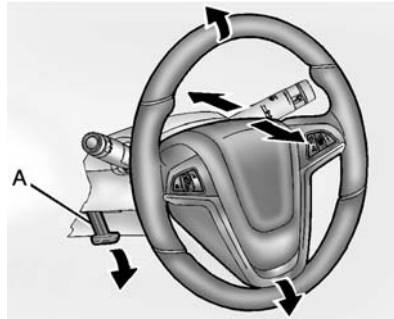

Unlock lever (A), adjust steering wheel, then engage lever and ensure it is fully locked.

Do not adjust steering wheel unless vehicle is stationary and steering wheel lock has been released.

Steering wheel controls

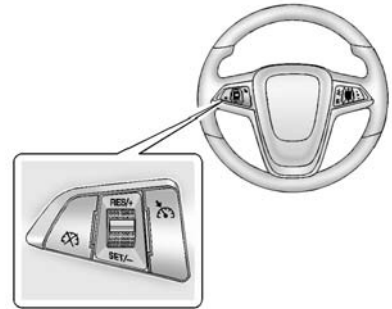

The Infotainment system and the cruise control can be operated via the controls on the steering wheel.



Further information is available in the Infotainment system manual.

Cruise control ↷ 118.

Horn

Press the  symbol on the steering wheel to sound the horn.

Do not use the horn as pedestrian safety alert.

Pedestrian safety alert

Pedestrian safety alert enables the driver to alert people who may not hear the vehicle approaching.

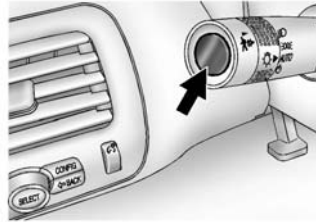

Momentarily push  on the end of the turn and lane-change lever and a soft-note alert will momentarily sound.

Repeat for additional activations of the pedestrian safety alert.

The pedestrian safety alert is only available when the vehicle is moving less than 40 mph or is stopped and is not in **P (Park)**.

Windscreen wiper/washer

Windscreen wiper



2 = fast

1 = slow

 = interval wiping

O = off

For a single wipe when the windscreen wiper is off, press the lever down to .

Do not use if the windscreen is frozen.

Switch off in car washes.

Adjustable wiper interval

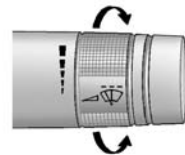

Wiper lever in position .

Turn the adjuster wheel to adjust the desired wipe interval:

short interval = turn adjuster wheel upwards
 long interval = turn adjuster wheel downwards

Windscreen washer

Pull lever. Washer fluid is sprayed onto the windscreen and the wiper wipes a few times.

Clock

The clock is shown in the Colour-Info-Display.

Set clock

1. Press the time program button to go directly to the time setting page or press the **CONFIG** button and select **Time** from the list.
2. Turn the **TUNE/MENU** knob to scroll through the available setup features.

3. Press the **TUNE/MENU** knob or press the time screen button to display other options within that feature.
4. Press + or - to increase or decrease the hours and minutes displayed on the clock.

Selectable setting options:

- **12 hours / 24 hours format:** Changes indication of hours between 12 hours and 24 hours.
- **Day + or Day -:** Increases or decreases the day shown in the Colour-Info-Display.
- **Display:** Switches time display on or off.

Vehicle personalisation  82.

Power outlets

Three 12 volt accessory power outlets are located as follows:

- Inside the front of the centre floor console.
- On the rear of the centre floor console.
- Inside the instrument panel storage compartment.

Do not exceed the maximum power consumption of 180 watts.

 **Danger**

Power outlet works under high electrical voltage!

The power outlets supply power while the ignition is on or if the vehicle is in the retained power off-mode.

Retained power off  104.

Electrical accessories that are connected must comply with the electromagnetic compatibility requirements laid down in DIN VDE 40 839.

Do not connect any current-delivering accessories, e.g. electrical charging devices or batteries.

Do not damage the outlets by using unsuitable plugs.

Warning lights, gauges and indicators

Speedometer

Indicates vehicle speed.

The shown unit can be changed in the Driver Information Centre (DIC).

Driver Information Centre (DIC)
⇨ 67.

Odometer

Displays the recorded distance.

Trip odometer

Displays the used fuel, average fuel economy and recorded distance since the last trip reset.

Reset the trip data by pressing and holding the **SELECT** button located left to the steering wheel when either trip A or trip B is displayed.

The trip odometer is within the Driver Information Centre (DIC).

Driver Information Centre (DIC)
⇨ 67.

Fuel gauge



This indicator displays the fuel level.

When this indicator is in the foreground, the vehicle is operating in extended range mode.

The value next to the indicator displays an estimate of how far the vehicle can be driven while in this mode.

Extended range mode ⇨ 106.

Battery gauge



This indicator displays the high voltage battery charge level.

When this indicator is displayed in the foreground, the vehicle is operating in electric mode. The value next to the indicator displays an estimate of how far the vehicle can be driven while in this mode.

Electric mode ⇨ 106.

Driving efficiency gauge



This gauge is a guide to driving in an efficient manner by keeping the ball green and in the centre of the gauge. The leaves stop spinning when the vehicle stops or when the ball travels away from the centre of the gauge.

accel: If the ball turns yellow and travels above the centre of the gauge, acceleration is too aggressive to optimise efficiency.

brake: If the ball turns yellow and travels below the centre of the gauge, braking is too aggressive to optimise efficiency.

Driving economically ⇨ 101.

Total vehicle range



Total vehicle range is the remaining distance the vehicle can be driven combining the electric range and fuel range.

Driving economically ⇨ 101.

Service display

The engine oil life system displays the percentage of the remaining oil life. The lower the percentage, the closer the vehicle is to needing an oil change.

Based on driving conditions, the interval at which an engine oil and filter change will be indicated can vary considerably.

The system must be reset every time the engine oil is changed to allow proper functionality. Seek the assistance of a workshop.

Avoid accidental resetting of the engine oil life system. It cannot be reset accurately until the next oil change.

When the system has calculated that engine oil life has been diminished, **Change Engine Oil Soon** appears in the Driver Information Centre. Have engine oil and filter changed by a workshop within the next 600 miles.

Driver Information Centre ⇨ 67.

Service information ⇨ 176.

Control indicators

The control indicators described are not present in all vehicles. The description applies to all instrument versions. Depending on the equipment, the position of the control indicators may vary. When the

ignition is switched on, most control indicators will illuminate briefly as a functionality test.

The control indicator colours mean:

- red = danger, important reminder
- yellow = warning, information, fault
- green = confirmation of activation
- blue = confirmation of activation
- white = confirmation of activation

Control indicators in the instrument cluster

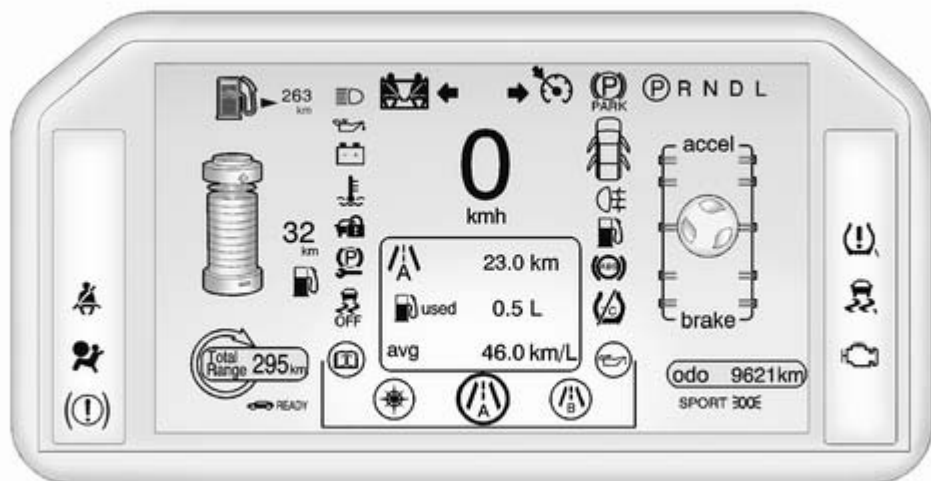

Turn signal

Illuminates or flashes green.

Flashes

The control indicator flashes if a turn signal or the hazard warning flashers are activated.

Fast flashing: failure of a turn signal light or associated fuse.

Bulb replacement ⇨ 143.

Fuses ⇨ 147.

Turn signals ⇨ 92.

Seat belt reminder

Seat belt reminder on front seats

 for driver's seat illuminates or flashes red.

 for front passenger seat illuminates or flashes red, when seat is occupied.

The seat belt reminder of the front passenger seat may also turn on if an object is put on the seat.

Illuminates

After the warning lights of the respective front seat have flashed for a while, until the seat belt has been fastened.

Flashes

Up to a certain time after the ignition has been switched on.

Seat belt status on rear seats

 flashes or illuminates.

Illuminates

After the ignition has been switched on, the seat belt light illuminates red.

After the passenger seat belts have been buckled, the corresponding seat belt light turns green.

Flashes

While the vehicle is moving, if a second row passenger who was previously buckled becomes unbuckled, the corresponding seat belt symbol will flash red for several seconds and a chime may sound.

Fastening the seat belt ⇨ 37.

Airbag and belt tensioners

 illuminates red.

When the ignition is switched on, the control indicator illuminates for several seconds. If it does not illuminate, does not go out after some seconds or illuminates whilst driving, there is a fault in the airbag system. Seek the assistance of a workshop. The airbags and belt pretensioners may fail to trigger in the event of an accident.

A message may also display in the Driver Information Centre (DIC).

Deployment of the belt pretensioners or airbags is indicated by continuous illumination of .

Warning

Have the cause of the fault remedied immediately by a workshop.

Belt pretensioners, airbag system
⇨ 36, ⇨ 40.

Driver Information Centre (DIC)

↪ 67.

Airbag deactivation

 illuminates yellow.

The front passenger frontal and knee airbag are activated.

 illuminates yellow.

The front passenger frontal and knee airbag are deactivated ↪ 42.

Danger

Risk of fatal injury for a child using a child restraint system on a seat with activated front passenger frontal and knee airbag.

Risk of fatal injury for an adult person on a seat with deactivated front passenger frontal and knee airbag.

If, after several seconds, both status indicator lights remain on or if there are no lights at all, there may be

a problem with the lights or the airbag deactivation switch. Seek the assistance of a workshop.

Charging system

 illuminates red.

Illuminates briefly when the ignition is switched on.

Light stays on or illuminates while driving

1. Move out of the flow of traffic as quickly as possible without impeding other vehicles.
2. Stop, switch off the ignition.
3. Seek the assistance of a workshop.

Driving while this light is on could drain the 12 volt battery.

Malfunction indicator light

 illuminates or flashes yellow.

Illuminates in service only mode

Illuminates as a check, showing if the service only mode is working. If a fault is detected, seek the assistance of your workshop.

Power button ↪ 102.

Illuminates when the ignition is on

Fault in the emission control system. The permitted emission limits may be exceeded.

The following may correct an emission system malfunction:

- Ensure that the fuel cap is installed correctly.
- Ensure that good quality fuel is used.

If none of the above have made the light turn off, seek the assistance of a workshop immediately.

Flashes when the ignition is on

Misfire condition has been detected. Ease up on the accelerator, reduce vehicle speed and/or avoid steep uphill grades until the flashing stops.

Should the light continues to flash:

1. Move out of the flow of traffic as quickly as possible without impeding other vehicles.
2. Stop, switch off the ignition.
3. Wait at least 10 seconds and switch the ignition on again.

If the light is still flashing, seek the assistance of a workshop.

Brake system

(C) illuminates red.

Illuminates after the ignition is switched on. The brake fluid level is too low or any other problem with the brake system exists.

Brake fluid level ⇨ 140.

Warning

Stop. Do not continue your journey. Consult a workshop.

Electrical parking brake

(P) illuminates or flashes red.

Illuminates

Electrical parking brake is applied ⇨ 114.

Flashes

If (P) flashes after the parking brake is released or while driving, do not drive and seek the assistance of a workshop immediately.

Electrical parking brake fault

(P) illuminates yellow.

Illuminates

Electrical parking brake is operating with degraded performance ⇨ 114.

Warning

Have the cause of the fault remedied immediately by a workshop.

An error message may be displayed in the Driver Information Centre (DIC).

Driver Information Centre ⇨ 67.

Antilock brake system (ABS)

(ABS) illuminates yellow.

Illuminates for a few seconds after the ignition is switched on. The system is ready for operation when the control indicator goes out.

If the control indicator does not go out after a few seconds, or if it illuminates while driving, there is a fault in the ABS. The brake system remains operational but without ABS regulation.

Try to reset the system.

To reset the system:

1. While driving, pull over when it is safe to do so.
2. Place the vehicle in **P**.
3. Switch the ignition off.
4. Restart the vehicle.

When the ABS control indicator remains on after resetting the system or comes on again while driving, seek the assistance of a workshop.

Antilock brake system ⇨ 113.

Should the warning lights of the ABS and the regular brake system come on, the vehicle may have a problem with the regular and the antilock brakes.

Have the vehicle towed for service.

Towing ⇨ 172.

Sport mode

Sport illuminates when sport mode is selected.

Sport mode ⇨ 107.

Mountain mode

Mountain illuminates when mountain mode is selected.

Mountain mode ⇨ 107.

Hold mode

Hold illuminates when hold mode is selected.

Hold mode ⇨ 107.

Electronic Stability Control off

 illuminates yellow.

The system is deactivated.

Electronic Stability Control and Traction Control system

 illuminates or flashes yellow.

Illuminates

A fault in the system is present. Continued driving is possible. Driving stability, however, may deteriorate depending on road surface conditions.

Have the cause of the fault remedied by a workshop.

Flashes

The system is active and is working to assist the driver with directional control of the vehicle in difficult driving conditions.

Electronic stability control ⇨ 117,
Traction control system ⇨ 116.

Traction Control system off

 illuminates yellow.

The system is deactivated.

Engine coolant temperature

 illuminates red.

Illuminates when the vehicle have a problem with the engine coolant system.

A warning chime sounds when the control indicator comes on.

Caution

If engine coolant temperature is too high, stop vehicle, switch off the ignition. Danger to engine. Check coolant level.

If the control indicator remains on, seek the assistance of your workshop.

Tyre pressure monitoring system

 illuminates or flashes yellow.

Illuminates

One or more of the tyres are significantly underinflated. Stop immediately and check tyre pressure.

Flashes

Fault in system. After about one minute the control indicator illuminates continuously. Seek the assistance of a workshop.

Engine oil pressure

 illuminates red.

Illuminates briefly when the vehicle is started.

Caution

Engine lubrication may be interrupted. This may result in damage to the engine and/or locking of the drive wheels.

1. Move out of the flow of traffic as quickly as possible without impeding other vehicles.
2. Set selector lever to **N**.
3. Switch off the ignition.

Check oil level before seeking assistance of a workshop ⇨ 138.

Low fuel

 illuminates when the fuel level is too low.

Immobiliser

 illuminates yellow.

Fault in the immobiliser system. The engine cannot be started.

Seek the assistance of a workshop.

Vehicle ready

 **READY** illuminates whenever the vehicle is ready to be driven.

Exterior light

 illuminates green.

The exterior lights are on ⇨ 90.

High beam

 illuminates blue.

Illuminated when high beam is on and during headlight flash ⇨ 91.

Rear fog light

 illuminates yellow.

The rear fog light is on ⇨ 92.

Cruise control

 illuminates white or green.

Illuminates white

The system is on.

Illuminates green

A certain speed is stored.

Cruise control  118.

Door open

If a door, the bonnet or the tailgate is opened, a light comes on together with a graphic in the Driver Information Centre (DIC).

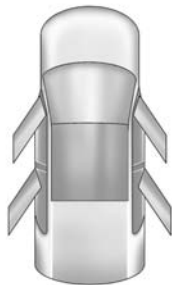

Door(s) open

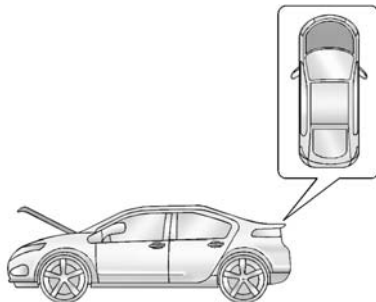

Bonnet open

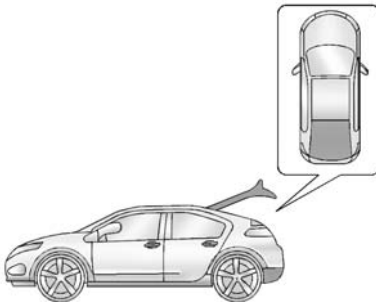

Tailgate open

The DIC indicates when a door, the bonnet, or the tailgate is open. The light displays the open area as shaded.

The DIC and the light both display when the vehicle is moving. Only the light displays if the vehicle is stopped.

Information displays

Driver Information Centre



The Driver Information Centre (DIC) display is located in the instrument cluster. The DIC displays information about the vehicle. If a system problem is detected, it also displays warning messages.

Vehicle messages ⇨ 81.

DIC controls

The menus and functions can be selected via the buttons located next to the steering wheel.

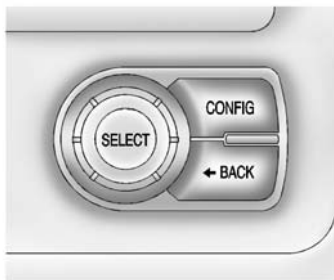

CONFIG: Press to select either the simple or enhanced instrument cluster configuration display.

← **BACK:** Press to return to the previous screen, to exit a screen or return to the main menu. Press ← **BACK** to minimise the DIC menu display.

SELECT: Press the centre of the knob to select the highlighted item. Turn the knob to scroll through the menu items.

Selecting menus and functions

At the main DIC menu:

1. Turn the **SELECT** knob to scroll through the possible DIC menus.
2. Press the centre of the **SELECT** knob when a menu item is highlighted to enter that menu.
3. Continue to turn and press the **SELECT** knob to scroll through and select the available menu items:

Trip A  and **Trip B** 
⇨ 57.

Remaining oil life 

The percentage of remaining oil life is displayed. The lower the percentage, the closer the vehicle is to needing an oil change.

Engine oil ⇨ 138.

Tyre pressure 

The approximate pressures of all four tyres are displayed.

If dashes are displayed instead of values, there may be a problem with the vehicle.

Seek the assistance of a workshop.

Tyre pressure ⇨ 156.

Tyre pressure monitoring system
⇨ 157.

Vehicle messages

Turn the **SELECT** knob to scroll through any active warning message. Press **SELECT** to review the messages.

Vehicle messages ⇨ 81.

Unit

Turn the **SELECT** knob to change the unit display between metric and imperial. Press **SELECT** to confirm the setting.

Tutorial mode

A screen that explains some of the unique features of the cluster is displayed by selecting this item.

Tutorial mode is only available when the vehicle is in park position **P**.

Turn-by-turn

The navigation system turn-by-turn guidance is displayed by selecting this item.

See the infotainment system manual for further information.

Instrument cluster display

The instrument cluster displays a preview of information that includes electric range, charging, odometer and battery status. This happens upon entry when the driver door is opened and following the welcome animation, before starting the vehicle.

A message may display on the lower left of the screen to indicate that a charging override or interruption has occurred due to an unintended interruption of AC power at the vehicle's charge port.

The following screens may appear, depending on the status.



This screen indicates that the charge cord is not connected. Plug the charge cord in to charge the vehicle.



This screen indicates that the charge cord is connected and charging is complete.



This screen indicates that charging is active and the estimated charge completion time is 10:00 a.m.

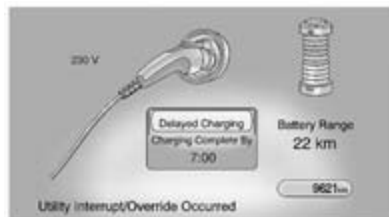

This screen indicates that charging is programmed to be delayed with an estimated completion time of 7:00 a.m.

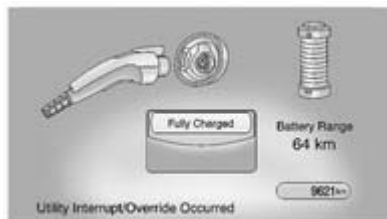

This screen indicates that the vehicle is fully charged and the charge cord is not connected.



This screen indicates that the charge cord is connected, but the vehicle cannot be charged.

Colour-Info-Display

Colour-Info-Display is located in the instrument panel.

Colour-Info-Display indicates:

- Climate control ↻ 95
- Infotainment system, see description in the infotainment system manual.
- Vehicle personalisation settings
- Power flow information
- Charging settings
- Energy information
- Time ↻ 56

The Colour-Info-Display controls only need a light touch to operate and work best with bare hands. The controls will work with most gloves although they may take longer to respond. Use the finger pad rather than the finger tip to minimise response time. If the controls are not responding, remove the gloves.

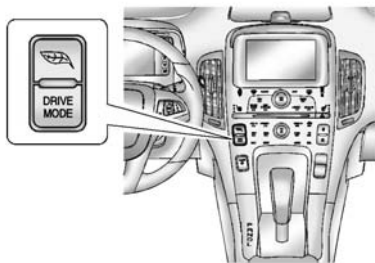

To view **Power Flow**, **Charging** and **Energy Info**, press  on the instrument panel.

Power Flow screens

To view the **Power Flow** screens, press  on the instrument panel and then press the **Power Flow** button at the top of the touch screen. The **Power Flow** screens indicate the current system operating condition. The **Power Flow** screens show the energy flow between the engine, electric drive unit and high voltage battery. These components will be highlighted when they are active.

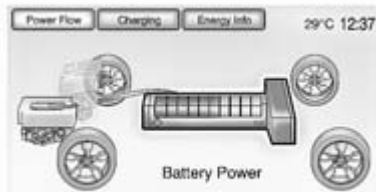

Battery Power - Battery is active with energy flowing to the wheels.



Battery Power - Vehicle is stationary in electric mode and no power is flowing to the wheels.

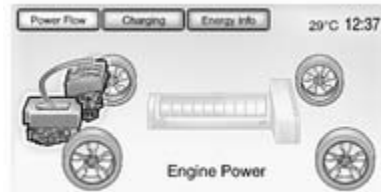

Engine Power - Engine is active with energy flowing to the wheels.

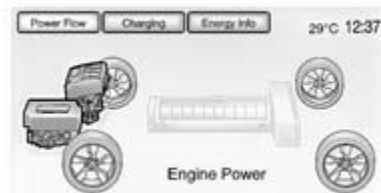

Engine Power - Vehicle is stationary in extended range mode and no power is flowing to the wheels.

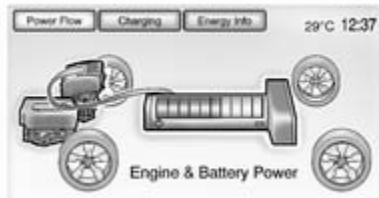

Engine & Battery Power - Both the engine and battery are active with energy flowing to the wheels.

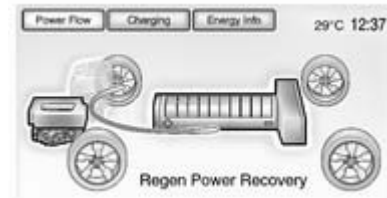
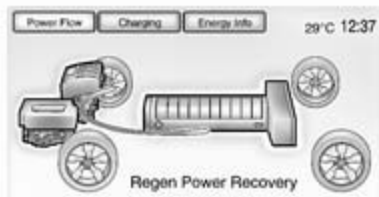

Regen Power Recovery - Power from the wheels returns to the battery during regenerative braking or coasting.

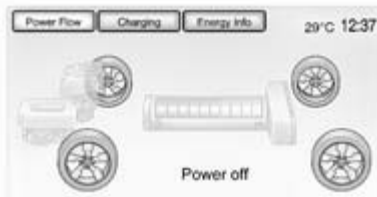

Power off - No power is flowing to the wheels.

Charging

Programmable charging

There are three programmable charge modes. To view the current charge mode status in the Colour-Info-Display, press  on the instrument panel and then press **Charging** at the top of the touch screen.

The current charge mode status can also be viewed in a temporary pop-up in the Colour-Info-Display by pressing the release button of the charge port door on the driver door. The **Charge Start** and **Charge Complete** time estimations are also displayed on the screen. These estimations are most accurate when the vehicle is plugged in and in moderate temperature conditions. Also, the vehicle uses the clock displayed in the Colour-Info-Display for programmable charging, so please ensure that the time displayed in the upper right hand corner of the Colour-Info-Display reflects the desired time of day.

Charge mode status



Immediately: The vehicle starts charging as soon as it is connected to an electrical outlet.

Charging ↻ 125.

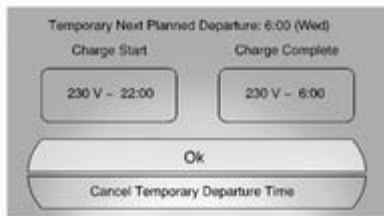
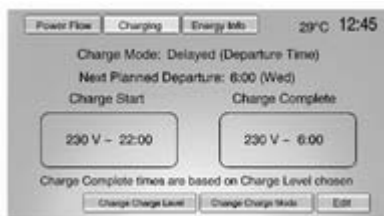

Delayed (Departure Time): The vehicle estimates the charging start time considering the programmed departure time for the current day of the week. Charging begins at the start time and is complete by the departure time only if sufficient time is allowed after the charge cord is plugged in.



Delayed (Rate & Departure Time): The vehicle estimates the charging start time based on the utility rate schedule, utility rate preference and the programmed departure time for the current day of the week. The vehicle will charge during the least expensive rate periods to achieve a full battery charge by the departure time. Electrical rate information from the utility company for the charging

location is required for this mode. Also, if the selected electric rate settings result in a very long charge completion time, the vehicle will start charging immediately upon plug-in. For example, if the electric rate table is setup with all peak rates and the rate preference is to charge during off-peak rates only, then the vehicle will start charging immediately upon plug-in.

Charge mode selection

From the charge mode status screen, press **Change Charge Mode**.

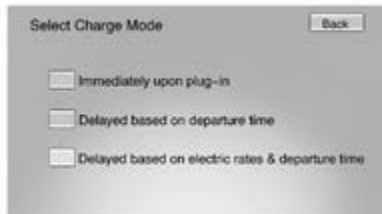

Select one option:

- **Immediately upon plug-in**
- **Delayed based on departure time**
- **Delayed based on electric rates & departure time**

Departure time entry

From the delayed charge mode status screen, press **Edit** to change the departure time for each day of the week.

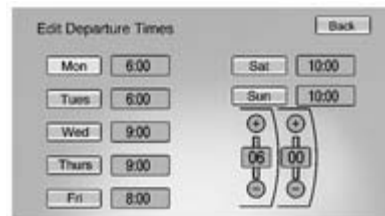

1. Press the day to change.
2. Press **+** or **-** to change the hours and minutes.
3. Press **Back** to store changes and return to the previous screen.

Charge level selection

The charge level preference setting allows the customer to select their vehicle's charge level so it matches the capability of their charging location. If the vehicle consistently stops charging after plugging in, or if a circuit breaker continues to trip, reducing to a lower charge level preference may resolve the issue.

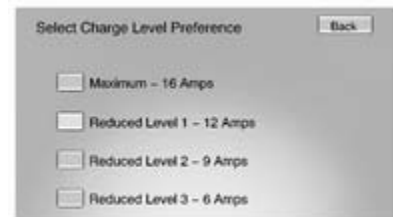

The charge level preference should be configured to match the electrical current rating for the AC outlet that the charge cord is connected to. The charge level preference settings are:

- **Maximum - 16 Amps:** Limits AC current to 16 ampere
- **Reduced Level 1 - 12 Amps:** Limits AC current to 12 ampere

- **Reduced Level 2 - 9 Amps:** Limits AC current to 9 ampere
- **Reduced Level 3 - 6 Amps:** Limits AC current to 6 ampere

Exact current levels for a particular region may vary from values shown in this manual. Please check vehicle for available levels.

The charge level preference settings are not directly related to the charge level button on the charge cord. The vehicle will adhere to the setting that minimises the AC current used to charge the vehicle.

The charge level preference setting will be retained between charging events. This setting should be referenced before charging to ensure that the vehicle is configured to properly match the electrical current rating for the AC outlet that the charge cord is connected to.

The charge level preference setting can be changed at any time while the Colour-Info-Display is operable.

Charge rate selection

From the delayed rate and departure time charge mode status screen, press **Edit**.

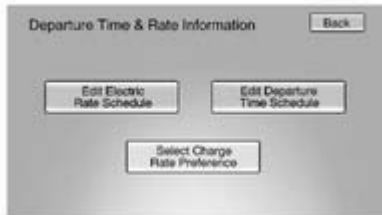

Select one of the following:

- **Edit Electric Rate Schedule**
- **Edit Departure Time Schedule**
- **Select Charge Rate Preference**

Charge rate preference selection

From the **Departure Time & Rate Information** screen, press **Select Charge Rate Preference**.

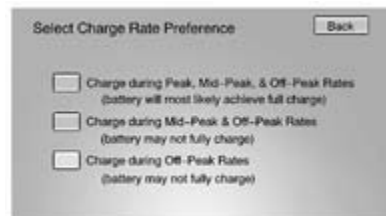

Press one of the following options to select the Charge Rate Preference:

- **Charge during Peak, Mid-Peak, & Off-Peak Rates:** The vehicle can charge during any rate period to satisfy the next planned departure time. However, it will select when to charge to minimise the total cost of the charge.
- **Charge during Mid-Peak & Off-Peak Rates:** The vehicle will charge during off-peak and/or mid-peak rate periods only and will select when to charge to minimise the total cost of the charge.
- **Charge during Off-Peak Rates:** The vehicle will only charge during off-peak rate periods.

Charging begins at the start time and is complete by the departure time only if sufficient time is allowed after the charge cord is plugged in. For example, if the vehicle is plugged in for only one hour prior to the departure time and the battery is completely discharged, the vehicle will not be fully charged by the departure time regardless of the rate selection.

Also, if the selected electric rate settings result in a very long charge completion time, the vehicle will start charging immediately upon plug-in. For example, if the electric rate table is setup with all peak rates and the rate preference is to charge during off-peak rates only, then the vehicle will start charging immediately upon plug-in.

Electric rate plan selection

Electric rates or cost per unit, may vary based on time, weekday / weekend and season. During the day when the demand for electricity is high, the rates are usually higher and called peak rates. At night when the

demand for electricity is low, the rates are usually lower and called off-peak rates. In some areas, a mid-peak rate is offered.

Contact the utility company to obtain the rate schedule for your area. The summer and winter start dates must be established to use a summer / winter schedule.

From the **Departure Time & Rate Information** screen, press **Edit Electric Rate Schedule**.



To edit **Summer/Winter Schedule**:

1. Press **Summer/Winter Schedule**.
2. Press **Edit**.



To edit the **Yearly Schedule**:

1. Press **Yearly Schedule**.
2. Press **Edit**.

Summer/Winter schedule start date entering

From the **Select Electric Rate Plan** screen, press **Summer/Winter Schedule** then press **Edit**.



1. Press **Summer Start**.
2. Press **+** or **-** to set the month and day for the start of summer.
3. Press **Winter Start**.
4. Press **+** or **-** to set the month and day for the start of winter.
5. Press **Edit Summer Schedule** or **Edit Winter Schedule** to edit the daily electric rate schedule.

Electric rate schedule editing

From the **Enter Summer/Winter Start Dates** screen, press **Edit Summer Schedule** or **Edit Winter Schedule**.

From the **Select Electric Rate Plan** screen, press **Yearly Schedule** and then press **Edit**.



1. Press **Weekday** or **Weekend**.
2. Press **Edit** next to the row to be changed.
 - ◆ Weekdays are Monday to Friday and use the same rate schedule.
 - ◆ Weekends are Saturday and Sunday and use the same rate schedule.

Both weekday and weekend schedules must be set. The rate schedule only applies for a 24 hour period, starting at 0:00 and ending at 0:00. There can be five rate changes for each day; not all must be used.

The finish times must be consecutive. If a finish time does not follow a start time, an error message displays. Follow the instructions given by the message.

Electric rate finish time editing

From the respective electric rate schedule screen, press **Edit** next to the row to change.

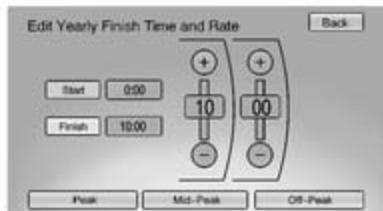
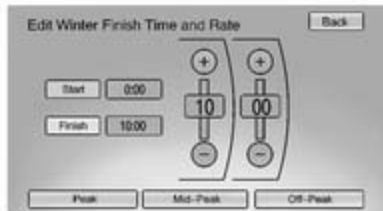
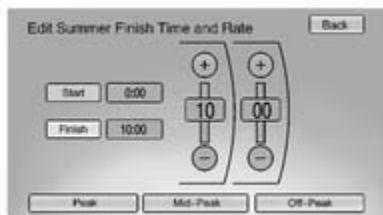

1. Press **+** or **-** to adjust the time.
2. Press **Peak**, **Mid-Peak** or **Off-Peak** to select the electric rate.
3. Press **Back** to store changes.

Only the finish time can be edited. The start time is automatically populated in the rate table.

Electric rate schedule viewing

From the **Select Electric Rate Plan** screen, press either **View Summer Schedule**, **View Winter Schedule** or **View Yearly Schedule**.

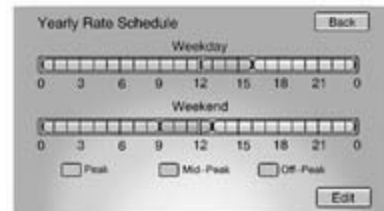
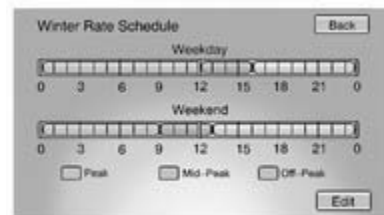
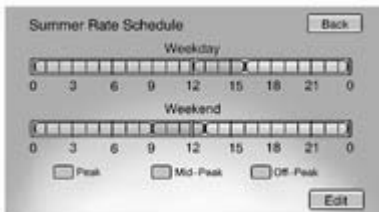

Temporary charge mode override and cancel

Programmed delayed charge modes can be temporarily overridden to an Immediate charge mode for one charge cycle. Also, the next planned departure time can be temporarily overridden for one charge cycle. In addition to the in-vehicle overrides via

the Colour-Info-Display, there are also other ways to temporarily override a delayed charge mode. Charging ↗ 125.

To temporarily override a delayed charge mode to immediate charge mode from inside the vehicle:

1. Press the release button of the charge port door on the driver door to view the charge mode status pop-up in the Colour-Info-Display.

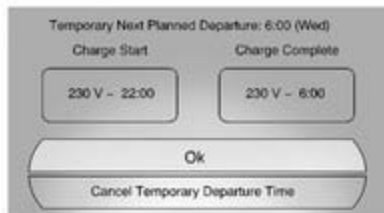

2. Press **Temporary Override**.

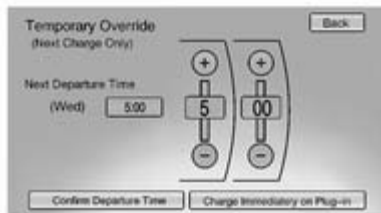

3. Press **Charge Immediately on Plug-in** to temporarily override an immediate charge mode.

The revised charge complete time will be automatically displayed.



To cancel the temporary override to immediate, press **Cancel Temporary Charge Mode** on the bottom of the touch screen of the temporary charge mode screen or pop-up, respectively.

To temporarily override the next planned departure time from inside the vehicle:

1. Press the release button of the charge port door on the driver door to view the charge mode status pop-up in the Colour-Info-Display.

2. Press **Temporary Override**.

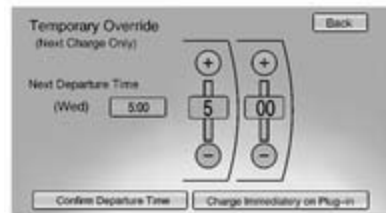

3. Press the **+** or **-** button to change the next departure time.
4. Press **Confirm Departure Time** to temporarily override the next planned departure time.

The revised charge complete time will be automatically displayed in the temporary charge mode screen.

Temporary departure time can only be updated for the same day as the original next planned departure time. Also, the vehicle will not accept a temporary departure time that is before the present time of day.

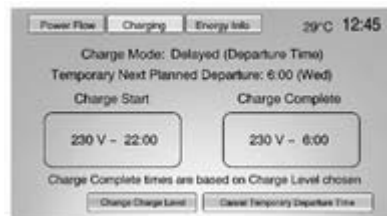

To cancel the temporary override of the next planned departure time, press **Cancel Temporary Departure Time** on the bottom of the touch screen of the of the touch screen of the temporary charge mode screen or pop-up, respectively.

Charging override / interruption pop-up



A pop-up will appear if the following occur:

- There was an unintended loss of AC power during the plug-in charge event. For example, there was a power outage or the charge cord was unplugged from the wall.

Programmable charging disabled



When the programmable charging system is disabled, the screen and the pop-up of the default charge mode status will display - - - - for the charge complete time. The programmable charging system will be disabled if the charge complete time cannot be confidently estimated.

If the programmable charging system is consistently disabled, seek the assistance of a workshop.

Energy information

To view the **Energy Usage**, **Energy Efficiency** and **Efficiency Tips**, press  on the instrument panel and then press **Energy Info** at the top of the touch screen.

Energy Usage

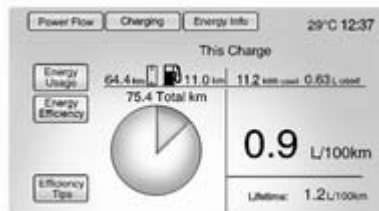

This screen displays information for the total of all the drive cycles since the last time the high voltage battery was fully charged. This includes distance travelled in electric mode, distance travelled in extended range mode, total distance travelled, electric energy used from the battery, total

fuel used and average fuel economy. There are maximum limits to some of the values that can be displayed. When these values are replaced with dashes, the value limits have been reached. To reset these values, the high voltage battery will need to be fully recharged. The circle graph also represents the percentage of distance travelled using electric mode versus extended range mode. The lifetime fuel economy is a total over the life of the vehicle and can only be reset by a workshop.

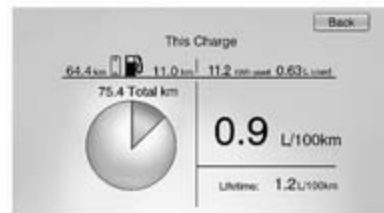

Energy usage information will also appear automatically on power off when the retained power off is active.

This automatic pop-up can be disabled through the vehicle personalisation.

Vehicle personalisation ⇨ 82.

Energy efficiency



This screen is accessed by pressing **Energy Efficiency** on the **Energy Usage** screen. This screen displays the energy efficiency over the drive cycle based on driving style and climate settings. Driving in a more efficient manner will result in a higher percentage displayed for driving style. Minimising the use of the climate control system will result in a higher percentage displayed for climate setting.

Efficiency Tips

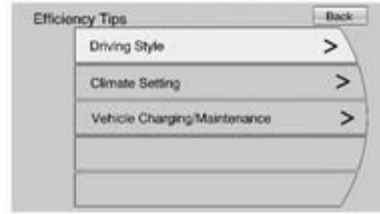

This screen is accessed by pressing **Efficiency Tips** from the **Energy Usage** or **Energy Efficiency** screen. This screen provides a guide on how to improve energy usage to increase fuel economy and range.

Vehicle messages

Messages displayed in the Driver Information Centre (DIC) indicate the status of the vehicle or some action that may be needed to correct a condition. Multiple messages may display one after the other.

Messages that do not require immediate action can be acknowledged and cleared by pressing the **SELECT** knob. The messages requiring immediate action cannot be cleared until that action is performed. All messages should be taken seriously. Clearing the messages does not correct the problem.

The vehicle messages are displayed as text. Follow the instructions given in the messages.

The system displays messages regarding the following topics:

- Fluid levels
- Starting
- Maintenance
- Anti-theft alarm system

- Brakes
- Ride control systems
- Cruise control
- Object detection systems
- Lighting, bulb replacement
- Wiper/washer system
- Doors, windows
- Radio remote control
- Airbag systems
- Engine and electric drive unit
- Tyres
- Battery and charging
- Vehicle operation modes
- Speed limit

Vehicle personalisation

Vehicle Personalisation can be accessed by using either the infotainment controls or the touch screen in the Colour-Info-Display. See the separate infotainment manual for more information.

Using the infotainment controls

Use the **TUNE/MENU** knob, the **CONFIG** and the **←BACK** buttons on the instrument panel to select personalisation features.

- **CONFIG:** Press to scroll through the available menus across the top of the touch screen display.
- **TUNE/MENU:**
 - ◆ Press to enter, select or activate a highlighted menu option.
 - ◆ Turn to highlight a menu option.
 - ◆ Press to turn a system setting on or off.
- **←BACK:**
 - ◆ Press to exit a menu.
 - ◆ Press to return to a previous screen.

Submenus

An arrow on the right-hand edge of the menu indicates that it has a submenu with other options.

Selecting a menu option

1. Turn the **TUNE/MENU** knob to highlight the function.
2. Press the **TUNE/MENU** knob to select the highlighted option. A checkmark next to the option indicates the selected option.

Turning a function on or off

1. Turn the **TUNE/MENU** knob to highlight the function.
2. Press the **TUNE/MENU** knob to turn the function on or off.
A checkmark next to the function indicates that the function is on.

Using the touch screen

Use the touch screen icons and menus on the Colour-Info-Display to select personalisation features.

△ = Touch to scroll up.

▽ = Touch to scroll down.

Back: Touch **Back** in the upper right corner of the display to return to the previous menu.

Submenus

An arrow on the right-hand edge of the menu indicates that it has a submenu with other options.

Selecting a menu option

Touch any one of the available menu options on the touch screen to select the option. A checkmark next to the option indicates the selected option.

Turning a function on or off

Touch the screen where the available function is listed to turn it on or off. A checkmark next to the function indicates that the function is on.

Entering the personalisation menu

Press vehicle menu on the touch screen.

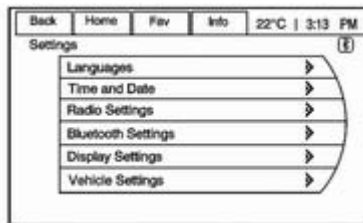

The vehicle menu features may include:

- Climate and air quality
- Comfort & Convenience
- Languages
- Exterior ambient lighting
- Power door locks
- Remote Lock / Unlock / Start
- Restore factory settings

Climate and air quality

Select the **Climate and air quality** menu to display:

- Auto fan speed
- Auto heated seats
- Heated seats at remote start
- Auto demist
- Engine Assisted Heating
- Engine Assisted Heating (Plugged-In)

Auto fan speed

Auto fan speed sets the automatic fan speed to maintain the desired interior temperature. Choose a blower setting:

High: Increased speed.

Medium: Moderate speed.

Low: Reduced speed.

To select the **Auto fan speed**:

1. Press the vehicle menu.
2. Select **Climate and air quality**.
3. Select **Auto fan speed**.
4. Select the fan speed.
5. Press **Back** to return to the previous menu.

Auto heated seats

When enabled, the auto heated seat buttons on the touch screen will be highlighted. This feature will automatically activate heated seats at the level required by the interior temperature. **Auto heated seats** can be turned off by using the heated seat buttons on the instrument panel.

To turn **Auto heated seats** on or off:

1. Press the vehicle menu.
2. Select **Climate and air quality**.
3. Turn the **Auto heated seats** on or off.
4. Press **Back** to return to the previous menu.

Heated seats at remote start

When on, this feature will turn the heated seats on when using remote start.

To turn **Heated seats at remote start** on or off:

1. Press the vehicle menu.
2. Select **Climate and air quality**.
3. Turn **Heated seats at remote start** on or off.
4. Press **Back** to return to the previous menu.

Auto demist

When on and high humidity is detected, the climate control system will adjust the outside air, air conditioning or heat to decrease fogging. The fan speed may increase.

When high humidity is no longer detected, the system will return to previous operation.

To turn **Auto demist** on or off:

1. Press the vehicle menu.
2. Select **Climate and air quality**.
3. Turn **Auto demist** on or off.
4. Press **Back** to return to the previous menu.

Engine Assisted Heating

Engine Assisted Heating selects the outside temperature level at which the engine may run to assist heating in electric mode. A change in selection will not take affect until after the vehicle is first powered down.

Engine Assisted Heating options are:

- **At Cold Outside Temperatures**
- **At Very Cold Outside Temperatures**

To select the outside temperature level:

1. Press the vehicle menu.
2. Select **Climate and air quality**.

3. Select the temperature level.
4. Press **Back** to return to the previous menu.

Engine Assisted Heating (Plugged-In)

This feature will enable or disable **Engine Assisted Heating** whenever the vehicle is plugged in. A change in setting will not take affect until after the vehicle is first powered down.

To turn **Engine Assisted Heating (Plugged-In)** on or off:

1. Press the vehicle menu.
2. Select **Climate and air quality**.
3. Turn **Engine Assisted Heating (Plugged-In)** on or off.
4. Press **Back** to return to the previous menu.

Comfort & Convenience

Select the **Comfort & Convenience** menu and the following will be displayed:

- **Chime volume**
- **Button Chime**
- **Energy Summary Exit Pop-up**

- **Charging Cord Theft Alert**
- **Charging Power Loss Alert**
- **Personalization by driver**

Chime volume

This allows the selection of the chime volume level to be either normal or high.

To select the **Chime volume** level:

1. Press the vehicle menu.
2. Select **Comfort & Convenience**.
3. Select **Chime volume**.
4. Select the volume level.
5. Press **Back** to return to the previous menu.

Button Chime

This allows a tone to be heard when a selection is made using the infotainment system.

To turn **Button Chime** on or off:

1. Press the vehicle menu.
2. Select **Comfort & Convenience**.
3. Turn **Button Chime** on or off.
4. Press **Back** to return to the previous menu.

Energy Summary Exit Pop-up

This allows the **Energy Summary Exit Pop-up** to be turned on or off:

1. Press the vehicle menu.
2. Select **Comfort & Convenience**.
3. Turn **Energy Summary Exit Pop-up** on or off.
4. Press **Back** to return to the previous menu.

Charging Cord Theft Alert

This allows the **Charging Cord Theft Alert** to be turned on or off:

1. Press the vehicle menu.
2. Select **Comfort & Convenience**.
3. Turn **Charging Cord Theft Alert** on or off.
4. Press **Back** to return to the previous menu.

Charging Power Loss Alert

This allows the **Charging Power Loss Alert** to be turned on or off:

1. Press the vehicle menu.
2. Select **Comfort & Convenience**.

3. Turn **Charging Power Loss Alert** on or off.
4. Press **Back** to return to the previous menu.

Personalization by driver

This allows the radio to store favourites by driver:

1. Press the vehicle menu.
2. Select **Comfort & Convenience**.
3. Turn **Personalization by driver** on or off.
4. Press **Back** to return to the previous menu.

Languages

This allows selection of the desired language.

To select the language:

1. Press the vehicle menu.
2. Select **Languages**.
3. Select the desired language.
4. Press **Back** to return to the previous menu.

Exterior ambient lighting

Select the lighting menu and the following will be displayed:

- **Duration upon exit of vehicle**
- **Exterior lighting by unlocking**

Duration upon exit of vehicle

This allows the selection of how long the exterior headlights stay on when leaving the vehicle and it is dark outside.

The available options are:

- **Off**
- **30 seconds**
- **1 minute**
- **2 minutes**

To select the length of time the exterior lights will remain on:

1. Press the vehicle menu.
2. Select **Exterior ambient lighting**.
3. Select **Duration upon exit of vehicle**.

4. Select the length of time the exterior lights will remain on.
5. Press **Back** to return to the previous menu.

Exterior lighting by unlocking

This allows the vehicle locator lights to be turned on or off. When on, the headlights, sidelights, tail lights, number plate lights and reversing lights will illuminate when  is pressed on the radio remote control.

To turn **Exterior lighting by unlocking** on or off:

1. Press the vehicle menu.
2. Select **Exterior ambient lighting**.
3. Turn **Exterior lighting by unlocking** on or off.
4. Press **Back** to return to the previous menu.

Power door locks

Select **Power door locks** and the following will be displayed:

- **Auto door unlock**
- **Prevent doorlock while door open**
- **Delayed door lock**

Auto door unlock

This allows selection of which doors will automatically unlock when the vehicle is shifted into **P**.

The available options are:

- All doors
- Driver door
- Off

To select how the doors will automatically unlock:

1. Press the vehicle menu.
2. Select **Power door locks**.
3. Select **Auto door unlock**.
4. Select how the doors will automatically unlock.
5. Press **Back** to return to the previous menu.

Prevent doorlock while door open

When on, this feature will keep the driver's door from locking until the door is closed. If this feature is turned on, the **Delayed door lock** menu will not be available.

To turn **Prevent doorlock while door open** on or off:

1. Press the vehicle menu.
2. Select **Power door locks**.
3. Select **Prevent doorlock while door open**.
4. Turn **Prevent doorlock while door open** on or off.
5. Press **Back** to return to the previous menu.

Delayed door lock

When on, this feature will delay the locking of the doors. To override the delay, press the central locking buttons on the instrument panel.

To turn the delayed door lock feature on or off:

1. Press the vehicle menu.
2. Select **Power door locks**.
3. Turn **Delayed door lock** on or off.
4. Press **Back** to return to the previous menu.

Remote locking, unlocking, starting

Select **Remote Lock / Unlock / Start** and the following will be displayed:

- Remote lock feedback
- Exterior lighting by unlocking
- Door Unlock or Remote Door Unlock
- Remote left in vehicle reminder
- Passive door unlock
- Passive door lock

Remote lock feedback

This allows selection of what feedback is provided when unlocking the vehicle with the radio remote control.

The available options are:

- Lights and horn
- Lights only
- Horn only
- Off

To select remote lock feedback:

1. Press the vehicle menu.
2. Select **Remote Lock / Unlock / Start**.
3. Select **Remote lock feedback**.
4. Select the remote feedback.
5. Press **Back** to return to the previous menu.

Exterior lighting by unlocking

When on, the exterior lights will flash when unlocking the vehicle with the radio remote control.

To turn **Exterior lighting by unlocking** on or off:

1. Press the vehicle menu.
2. Select **Remote Lock / Unlock / Start**.
3. Turn **Exterior lighting by unlocking** on or off.
4. Press **Back** to return to the previous menu.



Door Unlock or Remote DoorUnlock

This allows selection of which doors will unlock when pressing  on the radio remote control.

The available options are:

- **All doors**
- **Driver door**

If **All doors** is selected, all doors will be unlocked.

If **Driver door** is selected, only the driver's door will be unlocked on the first press of . All doors will be unlocked on the second press of  within five seconds of the prior press.

To select how the doors will unlock with the radio remote control:

1. Press the vehicle menu.
2. Select **Remote Lock / Unlock / Start**.
3. Select **Door Unlock** or **Remote Door Unlock**.
4. Select how the doors will unlock.
5. Press **Back** to return to the previous menu.

Remote left in vehicle reminder

When on, the horn will chirp rapidly three times if a radio remote control is left in the vehicle.

To turn **Remote left in vehicle reminder** on or off:

1. Press the vehicle menu.
2. Select **Remote Lock / Unlock / Start**.
3. Turn **Remote left in vehicle reminder** on or off.
4. Press **Back** to return to the previous menu.

Passive door unlock

This allows selection of which doors are unlocked by pressing the button on the outside door handle.

The available options are:

- **All doors**
- **Driver door**

To select how the doors will unlock:

1. Press the vehicle menu.
2. Select **Remote Lock / Unlock / Start**.
3. Select **Passive door unlock**.

4. Select which doors to unlock.
5. Press **Back** to return to the previous menu.

Passive door lock

This allows passive locking to be turned on or off and select what type of feedback.

The available options are:

- **Off**
- **On**
- **ON with Active Chirp**

To select how the doors will unlock:

1. Press the vehicle menu.
2. Select **Remote Lock / Unlock / Start**.
3. Select **Passive door lock**.
4. Select **On, Off** or **ON with Active Chirp**.
5. Press **Back** to return to the previous menu.

Restore factory settings

This returns all of the vehicle personalisation settings to the factory settings.

1. Press the vehicle menu.
2. Select **Restore factory settings**.
3. Select **Yes** or **No**.
4. Press **Back** to return to the previous menu.

Lighting

Exterior lighting	90
Interior lighting	93
Lighting features	94

Exterior lighting

Light switch

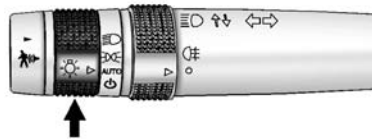

Turn adjuster wheel :

AUTO = automatic light control: exterior lighting is switched on and off automatically depending on external lighting conditions.

 = exterior lighting is switched off.

 = sidelights

 = headlights

Tail lights

Tail lights are illuminated together with headlights and sidelights.

Automatic light control

Automatic light control function

When the automatic light control function is switched on and the ignition is switched on, the system switches between daytime running light and headlight depending on the lighting conditions.

Daytime running light

Daytime running light increases visibility of the vehicle during daylight.

While the daytime running light is active, the tail lights and the sidelights are switched off. The instrument cluster will be lit.

If the ignition is switched on and the vehicle is stopped, the daytime running light can be turned off by moving the shift lever to **P**. The daytime running light will stay off until the shift lever is moved out of **P**. Please regard that the headlights should be turned on when needed.

Note

Do not cover the light sensor otherwise the AUTO mode will not operate properly.

Automatic headlight activation

During poor lighting conditions the headlights are switched on.

Tunnel detection

When a tunnel is entered, the headlights are switched on.

High beam

To switch from low to high beam, push the turn signal lever.

To switch to low beam, push lever again or pull.

Headlight flash

To activate the headlight flash, pull the turn signal lever.

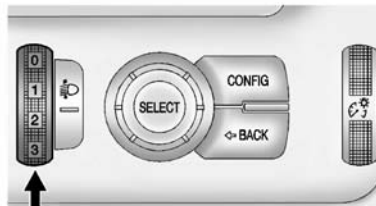
Headlight range adjustment

To adapt headlight range to the vehicle load to prevent dazzling: turn thumb wheel  to required position.

- 0 = front seats occupied
- 1 = all seats occupied
- 2 = all seats occupied and load compartment laden
- 3 = driver's seat occupied and load compartment laden

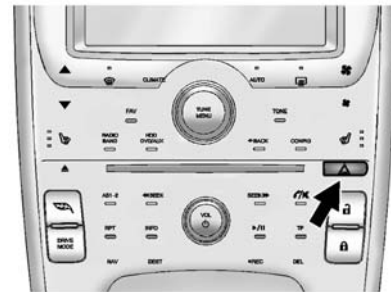
Hazard warning flashers

Operated with the  button.

In the event of an accident with airbag deployment, the hazard warning flashers are activated automatically.

Turn and lane-change signals

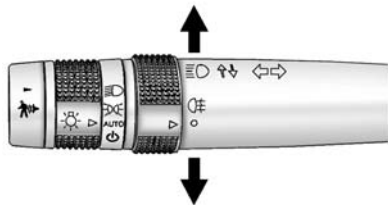

lever up = right turn signal
 lever down = left turn signal

If the lever is moved past the resistance point, the turn signal is switched on constantly. When the steering wheel moves back, the turn signal is automatically deactivated.

For three flashes, e.g. when changing lanes, press the lever until resistance is felt and then release.

Switch the turn signal off manually by moving the lever to its original position.

Turn signal control indicator ↷ 61.

Rear fog lights

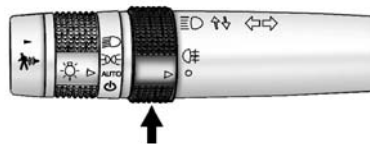

Turn the rear fog light band on the lever to  and release it, to turn the rear fog light on or off. The band will return to its original position.

The rear fog light is automatically set to off each time the car is started.

Head- and sidelights must be on for the rear fog lamp to work.

Parking lights

When the ignition is switched off, the parking lights on one side can be activated:

1. Switch off the vehicle.
2. Move turn signal lever all the way up (right parking lights) or down (left parking lights).

Confirmed by a signal and the corresponding turn signal control indicator.

The parking lights will remain illuminated until the ignition is switched on or the turn signal lever is returned to the neutral position.

Reversing lights

The reversing lights come on when the vehicle is turned on and reverse gear is selected.

Electric drive unit ↷ 111.

Misted light covers

The inside of the light housing may mist up briefly in poor, wet and cold weather conditions, in heavy rain or after washing. The mist disappears quickly by itself; to help switch on the headlights.

Interior lighting

Instrument panel illumination control

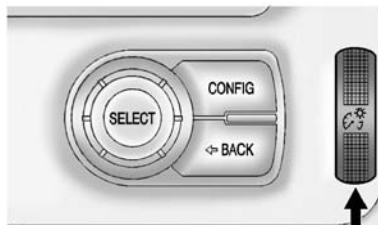

Brightness of the following lights can be adjusted when the exterior lights are on:

- Instrument panel cluster display
- Infotainment display
- Illuminated switches and operation elements

Turn thumb wheel  up or down to brighten or dim the lights.

Dome lights

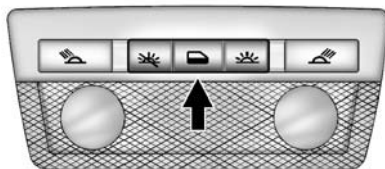

The dome light controls are located in the overhead console.

To operate, press the following buttons:



Press  = automatic switching on and off

Press  = on

Press  = off

Reading lights

There are front and rear reading lights.

The reading lights are operated with  and  for the respective light.

Front reading lights

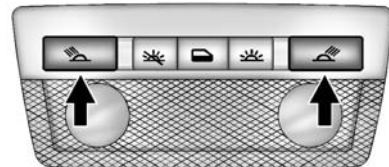

The front reading lights are located in the overhead console.

Rear reading lights



The rear reading lights are located in the headliner.

Lighting features

Entry lighting

Headlights, taillights, reversing lights, sidelights and the interior lights turn on briefly by pressing  on the radio remote control.

The lights turn off immediately when the  button is pressed or automatically after a brief period.

Exit lighting

The headlights, parking lights, tail lights, reverse light and the number plate lights come on by doing the following:

1. Switch off ignition.
2. Open the driver's door.
3. Pull the turn signal lever briefly and release.

Some interior lights come on when the ignition is switched off. The exterior and the interior lights remain on after the door is closed for a brief period and then turn off.

Activation, deactivation and duration of this function can be changed in the Colour-Info-Display.

Vehicle personalisation ⇨ 82.

Battery discharge protection

The battery saver feature is designed to protect the vehicle's 12 volt battery.

If any interior light is left on and the ignition is switched off, the battery rundown protection system automatically turns the lights off after about 10 minutes.

If the exterior lights are left on, they turn off when the vehicle power is turned off. If the parking lights are turned on when the vehicle power is off, the parking lights remain on until they are manually turned off.

Climate control

Climate control systems	95
Air vents	100
Maintenance	100

Climate control systems

Automatic climate control system

Note

The vehicle may require the use of an auxiliary heat source under certain cold conditions. This provides additional heating and defrost capability obtained by running the engine, even if the high voltage battery is adequately charged. Under these conditions, the engine will start and use fuel. Make sure there is fuel in the tank.

Note

Do not allow the vehicle to remain in extreme temperatures for long periods without being driven or being plugged in.

Note

Do not cover the sensor located on top of the instrument panel, otherwise the automatic climate control system may not work properly.

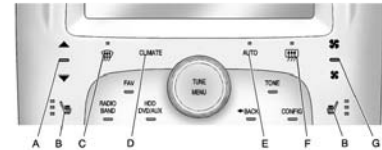

- A = Temperature control
- B = Heated seats
- C = Defrost
- D = Climate
- E = **AUTO**
- F = Rear window heating
- G = Manual fan control

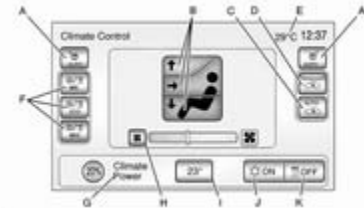

- A = Auto heated seats
- B = Air delivery mode controls
- C = Auto recirculation
- D = Manual recirculation

- E** = Outside air temperature display
- F** = Climate modes
- G** = Climate power gauge
- H** = Manual fan control
- I** = Temperature setting display
- J** = Air conditioning indicator
- K** = Heat status indicator

Climate control touch screen

The climate mode, fan, air delivery, recirculation and auto heated seats are controlled by pressing the **CLIMATE** button on the instrument panel and viewing information in the Colour-Info-Display.

Climate mode operation

Three different climate mode settings can be selected. These settings adjust the impact the climate control system has on the vehicle's electric range or fuel economy.

To select a climate mode:

1. Press **CLIMATE** on the instrument panel.
2. Press the respective climate mode button on the touch screen. The climate mode will be lit.

Climate modes

Fan Only mode

The air conditioning and electric heat are turned off. As long as  is not selected, the climate control settings may not have a noticeable effect on the vehicle electric range and fuel economy.

When in **Fan Only** mode, the **AUTO** indicator light will be off. When **AUTO** is selected in **Fan Only** mode, the mode will change to either **ECO** or **Comfort**.

When in **Fan Only** mode, the air conditioning system may turn on automatically if the high voltage battery is being cooled. The climate control system could blow cold air. This is normal. To prevent cold air from blowing into the interior, turn off the fan control and select the vent mode and manual recirculation mode, and close the air vents.

When in **Fan Only** mode, if automatic defog is enabled, the air conditioning and electric heat may turn on when high humidity conditions exist.

Vehicle personalisation ⇨ 82.

The air conditioning may also run if  is selected.

ECO mode

The air conditioning and electric heat are controlled to balance comfort with fuel economy.

As long as  is not selected, the vehicle electric range or fuel economy will decrease less than in **Comfort** mode, but will result in moderate comfort.

Comfort mode

The air conditioning and electric heat are controlled to reach the best comfort level based on the temperature setting selected. In this mode, vehicle electric range or fuel economy will decrease depending on the amount of energy required to reach the best comfort levels.

Climate power gauge



When the climate mode is changed, the climate power gauge displays the impact that the changes have on energy use. The higher the reading, the more energy is being used.

Air conditioning / Heat status indicators



The air conditioning or heat status indicator displays when the air conditioning or electric heat is being used.

Air conditioning / Electric heating

Air conditioning and electric heating could be on at the same time when dehumidifying is required in **ECO** or **Comfort** modes.

In **Fan Only** mode, occasionally air conditioning and/or heating status will be on if the auto defog function is enabled and high humidity is detected.

Vehicle personalisation ⇨ 82.

Air conditioning may also run if  is selected, regardless of the climate mode.

Automatic operation

The system automatically controls the fan speed, air delivery mode and recirculation to heat or cool the vehicle to the selected temperature.

When the **AUTO** indicator light is on, the system is in full automatic operation. If the air delivery mode, fan speed or recirculation setting is adjusted, the **AUTO** indicator turns off and the selected settings display.

For automatic operation:

1. Press **AUTO**.
2. Set the temperature. An initial setting of 23°C is recommended. Allow the system time to stabilise. Adjust the temperature as needed.

Temperature control

Press ▲ or ▼ to increase or decrease the temperature.

Auto defog

The system monitors high humidity inside the vehicle. When detected, the system may adjust to outside air supply and turn on the air conditioning or the heater. The fan speed may slightly increase to help prevent fogging. When high humidity is no longer detected, the system will return to its prior operation.

Vehicle personalisation ⇨ 82.

Manual operation

Fan control

Press the fan control buttons  on the instrument panel or the touch screen fan control, to increase or decrease the fan speed. The fan speed setting is displayed. Press **AUTO** to return to automatic operation. To turn the fan or climate control system off, press the fan down button repeatedly.

If the fan is manually turned off while in **ECO** or **Comfort** mode, the display will automatically change to **Fan Only** mode. When the fan is turned back on either by manually increasing fan speed or pressing the **AUTO** button, the climate mode will revert back to **ECO** or **Comfort** mode.

Air delivery mode control

Press **CLIMATE** on the instrument panel to select the climate touch screen. Press the air delivery mode button on the touch screen to change the direction of the airflow. The selected air delivery mode button is lit. Pressing any of the air delivery buttons cancels automatic air delivery

control and the direction of the airflow can be controlled manually. Press **AUTO** to return to automatic operation.

To change the current mode, select one of the following:

: Air is directed to the instrument panel outlets.

: Air is divided between the instrument panel outlets and the floor outlets.

: Air is directed to the floor outlets.

: Air is directed to the windscreen and floor outlets to clear the windows of fog or moisture.

: Air is directed to the windscreen. The windscreen is cleared of fog or frost more quickly.

Selecting  will disable automatic control and the **AUTO** button indicator will not be lit.

Select  again to return to the previous climate settings.

If  is selected in **Fan Only** or **ECO** mode, air conditioning or electric heating may turn on and have a noticeable effect on vehicle electric range and fuel economy.

Auto recirculation



Warning

The exchange of fresh air is reduced in air recirculation mode. In operation without cooling the air humidity increases, so the windows may mist up from inside. The quality of the passenger compartment air deteriorates, which may cause the vehicle occupants to feel drowsy.

Press **AUTO**  to allow the system to automatically choose the air supply mode for best comfort, efficiency and defogging. Air is recirculated or outside air is pulled into the vehicle. The touch screen button is lit.

Manual recirculation

Press  to recirculate air inside the vehicle, press it again to select outside air. When selected, the touch screen button lights up to indicate that air is being recirculated. This helps to quickly cool the air inside the vehicle or prevent outside air and odours from entering.

Pressing  cancels automatic recirculation. Press **AUTO** or **AUTO**  to return to automatic operation; recirculation runs automatically as needed.

Manual recirculation mode is not available when defrosting or defogging is selected.

Auto heated seats

Press  **AUTO** for the respective seat on the touch screen. The button colour will change to green to confirm the setting. By switching on the ignition, **AUTO** heated seats will automatically activate the heated seats at the level required by the vehicle's interior temperature. The LEDs next to the seat heating symbol on the instrument panel indicates the

heat setting. Use the touch screen buttons or the manual heated seat buttons on the instrument panel to turn auto heated seats off.

Heated seats ⇨ 35.

Manual heated seats

Press  for the respective seat with the ignition on to operate the seat heating.

The controls are located on the instrument panel.

Heated seats ⇨ 35.

Heated rear window

Operated by pressing the  button.

Heated rear window ⇨ 31.

Heated rearview mirror ⇨ 29.

Remote start

Operated by pressing  on the radio remote control.

The climate control system will default to an appropriate heating or cooling mode and the rear window heating turns on in the event of cold outside temperatures.

Remote start ⇨ 20.

Compressor

The vehicle has an electric powered air conditioning compressor. This allows for continuous air conditioning and/or high voltage battery cooling operation, without running the engine.

Air vents

Use the slats on the air vents to change the direction of the airflow.

Use the thumbwheels near each vent to open and close off the airflow.

Warning

Do not attach any objects to the slats of the air vents. Risk of damage and injury in case of an accident.

Maintenance

Air intake

The air intake in front of the windscreen in the engine compartment must be kept clear to allow air intake. Remove any leaves, dirt or snow.

Pollen filter

The pollen filter cleans dust, soot, pollen and spores from the air entering the vehicle through the air intake.

Service

For optimal cooling performance, it is recommended to annually check the climate control system, starting three years after initial vehicle registration, including:

- Functionality and pressure test
- Heating functionality
- Leakage check

- Cleaning of condenser and evaporator drainage
- Performance check

Driving and operating

Driving hints	101
Starting and operating	102
Electric vehicle operation modes	106
Engine exhaust	111
Electric drive unit	111
Brakes	113
Ride control systems	116
Driver assistance systems	118
Charging	125
Fuel	132
Towing	134

Driving hints

Driving economically

Use the following tips to help maximise energy efficiency and range.

Driving style

Efficiency gauge in the instrument cluster

The ball indicator should be kept green and in the centre of the gauge.

Inefficient acceleration is indicated when the ball turns yellow and travels above the centre of the gauge.

Aggressive braking is indicated when the ball turns yellow and travels below the centre of the gauge.

Acceleration / braking / coasting

Avoid unnecessary rapid accelerations and decelerations.

Electric range is maximised at 50 mph and below. Higher speeds use more energy and can significantly reduce electric range.

Use cruise control when appropriate.

Plan ahead for decelerations and coast whenever possible. For example, do not rush to traffic signals.

Do not shift to **N** to coast. The vehicle recovers energy while coasting and braking in **D** or **L**.

Drive mode and PRNDL selection

Use normal mode when possible.

Sport mode provides more responsive acceleration than normal mode but can reduce efficiency.

Use mountain mode prior to climbing long, steep grades in mountainous areas. Be sure to engage mountain mode before starting to climb.

Mountain mode reduces electric range and power but may be needed to maintain speeds above 60 mph when climbing grades of 5 % or greater.

Use **L** in heavy stop-and-go traffic or when travelling downhill. **L** requires less brake pedal application and provides a controlled, efficient way to slow the vehicle down.

Vehicle charging / maintenance

Charging

Keep the vehicle plugged in, even when fully charged, to keep the battery temperature ready for the next drive. This is important when outside temperatures are extremely hot or cold.

Maintenance

Always keep the tyres properly inflated and the vehicle properly aligned.

The weight of excess cargo in the vehicle affects efficiency and range. Avoid carrying more than is needed.

If fuel is not regularly used, consider keeping the fuel tank only one-third full. Excess fuel weight impacts efficiency and range.

Use fuel rated at 95 RON or higher.

Avoid unnecessary use of electrical accessories. Power used for functions other than propelling the vehicle will reduce electric vehicle range.

Using a rooftop carrier will reduce efficiency due to additional weight and drag.

Control of the vehicle

Never coast with engine not running

Many systems will not function in this situation (e.g. brake servo unit, power steering). Driving in this manner is a danger to yourself and others.

Pedals

To ensure the pedal travel is uninhibited, there must be no mats in the area of the pedals.

Starting and operating

New vehicle running-in

The vehicle does not require a running-in period. Vehicle running-in is performed during manufacturing.

Power button

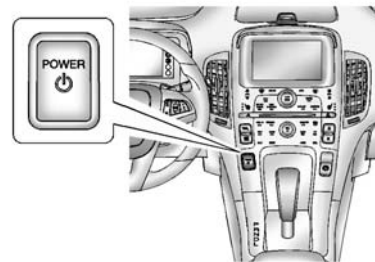



The vehicle has an electronic push-button start. The \odot button light flashes when the driver's door is open and the ignition is not on. The flashing light will eventually time out. The \odot

button light is on steady when the ignition is on. When the ignition is switched off, the  button light will also turn off.¹⁾

The radio remote control must be in the vehicle for the system to operate. If the vehicle will not start, place the mechanical key of the radio remote control inside the transmitter slot located in the instrument panel storage compartment.

Starting and stopping the vehicle
⇨ 104.



Switch on ignition

With the ignition off and the brake pedal applied, press  once to switch on the ignition. When the  **READY** light is on in the instrument cluster, the vehicle is ready to be driven. This could take up to 15 seconds at extremely cold temperatures. The engine will only start if needed. If the vehicle did not start, the instrument cluster will display a screen with inactive fuel and battery gauges.

Vehicle ready light⇨ 65.

Starting and stopping the vehicle
⇨ 104.

Service only mode

This power mode is available for service, diagnostics and to verify the proper operation of the malfunction indicator light as may be required for emission inspection purposes. With the ignition off and the brake pedal not applied, pressing and holding  for more than five seconds will place the vehicle in service only mode. The instruments and audio systems will operate as they do with the ignition on, but the vehicle will not be able to be driven. The propulsion system will not start in service only mode. Push  again to turn the ignition off.

Note

Service only mode will discharge the 12 volt battery. Do not use service only mode for an extended period, or the vehicle may not start.

Ignition off

To switch the ignition off, push button  with the vehicle in **P**. Retained power off will remain active until the driver's door is opened. When switching off the ignition, if the vehicle is not in **P**, the vehicle is not ready to be driven, but some of the electrical features of the vehicle can be used. A message will appear in the Driver Information Centre (DIC).

Retained power off ⇨ 104.

Electric drive unit ⇨ 111.

The vehicle has an electric steering column lock. The lock is activated when the ignition is switched off and either front door is opened. A sound may be heard as the lock actuates or releases. The steering column lock may not release with the wheels turned off centre. If this happens, the vehicle may not start. Move the steering wheel from left to right while attempting to start the vehicle. If this does not work, seek the assistance of a workshop.

¹⁾ Please regard that the operating condition of the vehicle is meant when "ignition on/off" is used.

If the vehicle must be shut off in an emergency:

Warning

Switching off the ignition while moving may disable the airbags. While driving, only shut the propulsion system off in an emergency.

1. Brake using a firm and steady pressure. Do not pump the brakes repeatedly. This may deplete power assist, requiring increased brake pedal force.
2. Shift the vehicle to **N**. This can be done while the vehicle is moving. After shifting to **N**, firmly apply the brakes and steer the vehicle to a safe location.
3. Come to a complete stop, shift to **P** and switch the ignition off by pushing button ϕ .
4. Set the parking brake \rightarrow 114.

If the vehicle cannot be pulled over and must be shut off while driving, press and hold ϕ for longer than two seconds or press twice within five seconds.

Retained power off

The following electronic systems can work until the driver's door is opened or at the latest for 10 minutes after the ignition is switched off:

- Power windows
- Audio system
- Accessory power outlets

Starting and stopping the vehicle

Starting

Move the shift lever to **P** or **N**. The propulsion system will not start in any other position.

Note

Do not try to shift to **P** if the vehicle is moving or the electric drive unit could be damaged. Shift to **P** only when the vehicle is stopped.

The radio remote control must be in the vehicle. Press the brake pedal and push ϕ . If the radio remote control is not in the vehicle or something is interfering with the transmitter, a message displays in the Driver Information Centre (DIC).

Radio remote control \rightarrow 20.



A welcome, ready, and goodbye audio message will be heard in the vehicle and animated on the instrument cluster when opening the driver's door upon entry, when the vehicle is ready to be driven and when the ignition is switched off. The instrument cluster displays an active fuel or battery gauge, along with an audio start-up cue, when the vehicle is ready to be driven. This could take up to 15 seconds at extremely cold temperatures. The engine will only start if needed. If the vehicle did not start, the instrument cluster will display a screen with inactive fuel and battery gauges.

Starting the vehicle with a low radio remote control battery

If the vehicle will not start due to a low radio remote control battery, a message displays in the DIC.

However, the vehicle can still be driven. Therefore proceed as follows:

1. Open the instrument panel storage and remove the rubber mat.



2. Extend the key blade and place the blade into the slot.
3. With the vehicle in **P** or **N**, apply the brake pedal and press \odot on the instrument panel.

Replace the radio remote control battery as soon as possible.

Battery replacement \diamond 20.

Restarting

If the vehicle must be restarted while it is still moving, move the shift lever to **N** and press \odot twice without pressing the brake pedal. The propulsion system will not restart in any other position.

Computers determine when the engine needs to run. The engine may start, if required, when the propulsion system is on. Some vehicle conditions that force the engine to run are:

- Cold ambient temperatures.
- The bonnet is open or not completely latched.
- The high voltage battery has a low charge.
- The engine is needed to maintain the high voltage battery temperature.
- The engine needs to run for maintenance \diamond 109.

A chime will sound if the driver's door is opened while the ignition is switched on. Always press \odot to switch the ignition off before exiting.

Stopping

Power button \diamond 102.

Parking

- Do not park the vehicle on an easily ignitable surface. Things that can burn could touch hot exhaust parts under the vehicle and ignite.
- Always apply the electrical parking brake. Pull switch (Ⓢ).
- Switch off the ignition. Turn the steering wheel until the steering wheel lock engages.
- If the vehicle is on a level surface or uphill slope, set the parking brake and then shift the selector lever to **P** before switching off the ignition. On an uphill slope, turn the front wheels away from the kerb.
If the vehicle is on a downhill slope, set the parking brake and then shift the selector lever to **P** before switching off the ignition. Turn the front wheels towards the kerb.
- Lock the vehicle and activate the anti-theft alarm system.

Electric vehicle operation modes

Operation

This vehicle is an extended range electric vehicle. It uses an electric propulsion system to drive the vehicle at all times. Electricity is the vehicle's primary source of energy, while petrol is the secondary source.

The vehicle has two modes of operation: Electric and extended range. In both modes, the vehicle is propelled by its electric drive unit. It converts electrical energy into mechanical energy to drive the wheels. The vehicle's performance remains the same in either mode.

Electric mode

In electric mode the vehicle does not use fuel or produce tailpipe emissions. During this primary mode, the vehicle is powered by electrical energy stored in the high voltage

battery. The vehicle can operate in this mode until the battery has reached a low charge.

There are some conditions when the battery charge is high enough to provide electric mode operation, but the engine still runs. They are:

- Cold ambient temperatures.
- Hot or cold high voltage battery temperatures.
- The bonnet being open or not completely closed and latched.
- Certain high voltage battery fault conditions.
- Engine maintenance mode or fuel maintenance mode being run.

Extended range mode

When the vehicle reaches the end of its electric range, it switches to extended range mode. In this secondary mode, electricity is produced by the fuel-powered engine. This secondary source of electric power extends the vehicle range. Operation will continue in extended range mode until the

vehicle can be plugged in to recharge the high voltage battery and restore electric mode.

The high voltage battery will continue to provide some power and work together with the engine to provide peak performance when it is required, such as driving up a steep incline or for high acceleration manoeuvres. The battery will not be charged nor will electric vehicle range be restored by the engine.

In either electric mode or extended range mode, when the bonnet is open, the engine will run without turning off if the ignition is on. The high voltage battery is neither charged nor discharged when this occurs.

In either electric mode or extended range mode, if there is a high voltage battery fault, the engine may run without turning off to generate the required electricity. The malfunction indicator light will turn on.

Malfunction indicator light ↗ 62.

Drive modes

While driving in electric or extended range mode, additional operating modes can be selected.

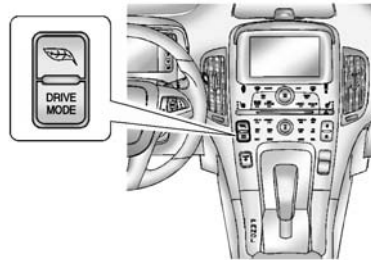

Press **DRIVE MODE** to display selectable drive modes in the Driver Information Centre (DIC). Continue pressing to scroll through the modes.



Highlight either the **Mountain**, **Sport**, or **Hold** mode, then release the **DRIVE MODE** button. After three seconds, the new drive mode will become active.

Pressing **DRIVE MODE** again will return to **Normal** mode and become active after three seconds.

At next start, the vehicle will default to **Normal** mode. Drive modes can then be selected again as desired.

During some conditions, certain drive modes may be unavailable. The unavailable mode is greyed out in the DIC menu and cannot be selected.

If in **Sport**, **Mountain** or **Hold** mode, the mode may become unavailable and the vehicle will return to **Normal** mode. The indicator light goes off and a DIC message displays.

Driver Information Centre (DIC) ⇨ 67.

Sport mode



Sport mode provides more responsive acceleration than **Normal** mode, but can reduce efficiency. Use **Normal** mode whenever possible.

Press **DRIVE MODE** to select **Sport** mode. Press **DRIVE MODE** again to return to **Normal** mode and it becomes active after three seconds.

Each time the vehicle is started, it will return to **Normal** mode.

Control indicator **Sport** ⇨ 64.

Mountain mode



Mountain mode should be selected at the beginning of a trip before climbing steep, uphill grades and when expecting to drive in very hilly or mountainous terrain. This mode maintains a reserve electrical charge of the high voltage battery to provide better grade climbing performance. While driving in **Mountain** mode, the vehicle will have less responsive acceleration. **Mountain** mode will not change normal vehicle braking performance for steep downhill grades.

Press **DRIVE MODE** to select **Mountain** mode. If steep hill driving is expected, it is recommended to select **Mountain** mode at least 20 minutes before driving on steep grades. This will allow the vehicle time to build a sufficient battery charge reserve.

If **Mountain** mode is not selected for these conditions, propulsion power may be reduced and the engine speed may increase.

The engine may run when **Mountain** mode is selected, depending on high voltage battery charge, to build reserve battery charge for uphill climbs. If **Mountain** mode is entered with a sufficient battery charge reserve, the estimated electric range will adjust accordingly and any battery charge reserve still unused upon exiting **Mountain** mode will be added back to the electric range display.

Press **DRIVE MODE** again to return to **Normal** mode and it becomes active after three seconds.

Each time the vehicle is started, it will return to **Normal** mode to maintain a smaller battery charge reserve for normal driving.

Control indicator **Mountain** ⇨ 64.

Hold mode



Hold mode is only available when the vehicle is in electric mode. This mode places the remaining battery charge into a reserve for the driver to use as desired. Selecting this mode transitions the vehicle to extended range mode to maintain the battery charge reserve.

Upon exiting **Hold** mode, the reserved battery charge becomes available again and the vehicle returns to electric mode. If the transition is from

Hold mode directly to **Mountain** mode, the electric range displayed adjusts for the **Mountain** mode charge reserve.

Hold mode will not change normal vehicle acceleration or braking performance.

Press **DRIVE MODE** to select **Hold** mode.

Press **DRIVE MODE** again to return to **Normal** mode and it becomes active after three seconds.

Each time the vehicle is started, it will return to **Normal** mode.

Control indicator **Hold** ⇨ 64.

Maintenance modes

Engine maintenance mode

Engine maintenance mode runs the engine to keep it in good working condition after approximately six weeks of no or very limited engine operation. Engine maintenance mode will force the engine to run, even if there is a charge to power the vehicle. When engine maintenance mode is

needed, a request screen appears on the Colour-Info-Display at vehicle start.

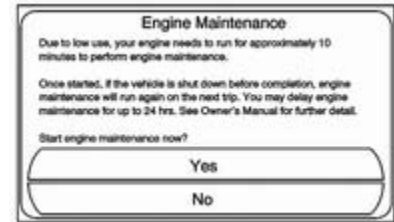

If **Yes** is selected, engine maintenance mode will begin. The engine will run for a set amount of time without turning off. During engine maintenance mode, a DIC message displays to show the engine maintenance mode percentage complete.

If **No** is selected, the engine maintenance mode request screen will appear when the vehicle is next started. The engine maintenance mode request can be delayed for only one day.

If the engine maintenance mode request was delayed for one day, it will automatically start the engine at the next vehicle start. An engine maintenance mode notification screen will appear in the Colour-Info-Display.

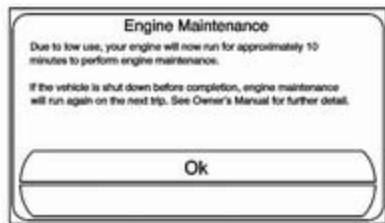

If the vehicle shuts off during engine maintenance mode, it will restart the next time the vehicle is driven. A message displays to indicate that engine maintenance mode is active.

If engine maintenance mode is required and the fuel level is low, engine maintenance mode may eventually empty the fuel tank if fuel is not added. This will result in

reduced, or no power. An adequate fuel level must be maintained in the vehicle to keep it operational.

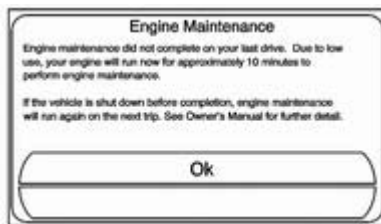

Driver Information Centre (DIC) ⇨ 67.

Fuel maintenance mode

Fuel maintenance mode tracks average fuel age. Old fuel can cause engine problems. If low engine usage causes average fuel age to exceed approximately one year, fuel maintenance mode will run the engine to use up the old fuel. The engine will run until enough fresh fuel is added to bring the average fuel age into an acceptable range. Allowing more old fuel to be used up by fuel maintenance mode and adding a larger amount of fresh fuel will

maximise the length of time before another fuel maintenance mode is needed. During fuel maintenance mode the engine may turn on and off. When fuel maintenance mode is needed, a request screen appears on the Colour-Info-Display at vehicle start.

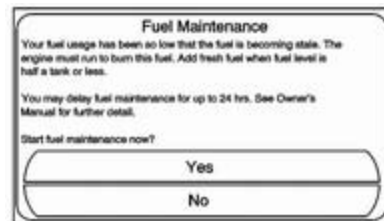

If **Yes** is selected, fuel maintenance mode will begin. Fuel maintenance mode will automatically continue at each vehicle start until fresh fuel is added.

If **No** is selected, the fuel maintenance mode request screen will appear when the vehicle is next started. The fuel maintenance mode request can be delayed for only one day.

If the fuel maintenance mode request was delayed for one day, it will start at the next vehicle start and display the fuel maintenance mode notification screen on the Colour-Info-Display.

If fuel maintenance mode is required and the fuel level is low, fuel maintenance mode may eventually empty the fuel tank if fuel is not added. This will result in reduced, or no power. An adequate fuel level must be maintained in the vehicle to keep it operational.

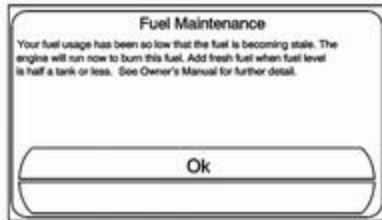

Engine exhaust

⚠ Danger

Engine exhaust gases contain poisonous carbon monoxide, which is colourless and odourless and could be fatal if inhaled.

If exhaust gases enter the interior of the vehicle, open the windows. Have the cause of the fault rectified by a workshop.

Avoid driving with an open load compartment, otherwise exhaust gases could enter the vehicle.

Electric drive unit

Operation

The vehicle uses an electric drive unit. The shift lever is located on the console between the seats.

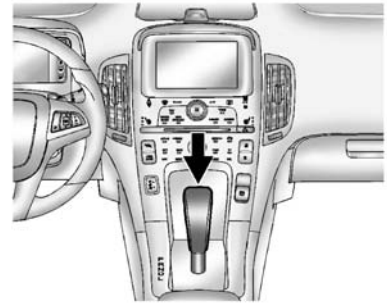

P (Park): This position locks the front wheels. It is the best position to use when starting the propulsion system because the vehicle cannot move easily.

⚠ Warning

It is dangerous to get out of the vehicle if the shift lever is not fully in **P** with the parking brake firmly set. The vehicle can roll.

Do not leave the vehicle when the propulsion system is running, the vehicle can move suddenly. You or others could be injured. To be sure the vehicle will not move, even when you are on fairly level ground, always set the parking brake and move the shift lever to **P**.

Make sure the shift lever is fully in **P** before starting the propulsion system. The vehicle has an electric drive unit shift lock control system. The brake pedal must be fully applied first and then the shift lever button pressed before shifting from **P** when the ignition is on. If you cannot shift out of **P**, ease the pressure on the shift lever, then push the shift lever all the way into **P** as you maintain brake

pedal application. Then press the shift lever button and move the shift lever into another gear.

Note

If you have continuous problems to move the shift lever from **P** as mentioned, seek the assistance of a workshop.

Note

The shift lock is always functional except in the case of an uncharged or low charged 12 volt battery.

Try charging or jump starting the 12 volt battery.

Jump start ⇨ 168.

(R) Reverse: Use this gear to back up.

Note

Shifting to **R** while the vehicle is moving forward could damage the electric drive unit. Shift to **R** only after the vehicle is stopped.

(N) Neutral: In this position, the propulsion system does not connect with the wheels.

(D) Drive: This position is for normal driving. It provides the best fuel economy. If more power is needed for passing, and the vehicle is:

- Going less than 35 mph, push the accelerator pedal about halfway down.
- Going about 35 mph or more, push the accelerator all the way down.

Note

If the vehicle seems to accelerate slowly or not respond when you go faster, and you continue to drive the vehicle that way, you could damage the electric drive unit.

Seek the assistance of a workshop.

(L) Low: This position reduces vehicle speed without using the brakes. You can use **L** on hills. It can help control vehicle speed going down steep mountain roads along with using the brakes off and on. You can use **L** on very steep hills, in deep snow or in mud.

Note

Spinning the tyres or holding the vehicle in one place on a hill using only the accelerator pedal may damage the electric drive unit. If you are stuck, do not spin the tyres. When stopping on a hill, use the brakes to hold the vehicle in place.

Brakes**Antilock brake system**

Antilock brake system (ABS) prevents the wheels from locking.

ABS starts to regulate brake pressure as soon as a wheel shows a tendency to lock. The vehicle remains steerable, even during hard braking.

ABS control is made apparent through a pulse in the brake pedal and the noise of the regulation process.

For optimum braking, keep the brake pedal fully depressed throughout the braking process, despite the fact that the pedal is pulsating. Do not reduce the pressure on the pedal.

After starting off, the system performs a self-test which may be audible.

Control indicator  ↪ 63.

Fault** Warning**

If there is a fault in the ABS, the wheels may be liable to lock due to braking that is heavier than normal. The advantages of ABS are no longer available. During hard braking, the vehicle can no longer be steered and may swerve.

Have the cause of the fault remedied by a workshop.

Parking brake

Electrical parking brake

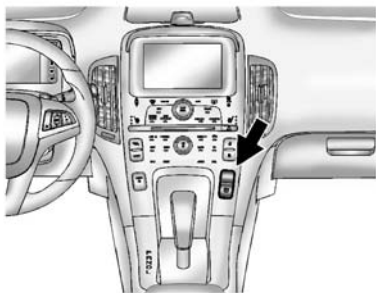



The electrical parking brake can always be activated, even if the ignition is off. To prevent draining of the 12 volt battery, avoid repeated cycles of the electrical parking brake system when the ignition is off.

In case of insufficient electrical power, the electrical parking brake cannot be applied or released.

Before leaving the vehicle, check the control indicator  to ensure the parking brake is applied.



Electrical parking brake apply



The electrical parking brake can be applied anytime the vehicle is stopped. The electrical parking brake is applied by momentarily lifting up on the  switch. Once fully applied, the control indicator  will be on.



While the brake is being applied, the control indicator  will flash until full apply is reached. If the light does not come on, or remains flashing, seek the assistance of a workshop.





Do not drive the vehicle if the control indicator  is flashing.

If the electrical parking brake is applied while the vehicle is in motion, a chime will sound and a message displays in the the Driver Information Centre (DIC). The vehicle will decelerate as long as the switch is held in the up position.

Releasing the  switch during the deceleration, will release the parking brake. If the  switch is held in the up position until the vehicle comes to a stop, the electrical parking brake will remain applied.

If the control indicator  flashes continuously, the electrical parking brake is only partially applied or released or there is a problem with the electrical parking brake. If so, a message is displayed in the Driver Information Centre (DIC). If  flashes continuously, release the electrical parking brake and attempt to apply it again. If  continues to flash, do not drive the vehicle. Seek the assistance of a workshop.

If the electrical parking brake fault indicator  is on, the electrical parking brake has detected a system problem and is operating with reduced functionality. To apply the electrical parking brake when  is on, lift up on the  switch and hold it in the up position.

Full application of the parking brake by the electrical parking brake system may take a longer period of time than normal when  is on. Continue to hold the  switch until the control indicator  remains on. If the electrical parking brake fault indicator  is on, seek the assistance of a workshop.

If the electrical parking brake fails to apply, the rear wheels should be blocked to prevent vehicle movement.

For maximum electrical parking brake force when parking on a hill, pull the electrical parking brake switch twice.

Electrical parking brake release

To release the electrical parking brake, switch the ignition on, apply and hold the brake pedal and push down momentarily on the (P) switch. If attempting to release the electrical parking brake without the brake pedal applied, a chime will sound and a message will be displayed in the DIC. The electrical parking brake is released when (P) is off.

If (E) is on, the electrical parking brake has detected a system problem, and is operating with reduced functionality. To release the electrical parking brake when (E) is on, push down on the (P) switch and hold it in the down position. Electrical parking brake release may take a longer period of time than normal when (E) is

on. Continue to hold the (P) switch until the control indicator (P) is off. If the light remains on, seek the assistance of a workshop.

Note

Driving with the parking brake on can overheat the brake system and cause premature wear or damage to brake system parts. Make sure that the parking brake is fully released and the control indicator (P) is off before driving.

Automatic release of the electrical parking brake

The electrical parking brake will automatically release if the vehicle is running, placed into gear and an attempt is made to drive away. Avoid rapid acceleration when the electrical parking brake is applied, to preserve parking brake lining life.

Electrical parking brake (P) control indicator ⇨ 63.

Electrical parking brake fault (E) control indicator ⇨ 63.

Driver Information Centre (DIC) ⇨ 67.

Regenerative braking

Regenerative braking takes some of the energy from the moving vehicle and turns it back into electrical energy.

This energy is then stored back into the high voltage battery system, contributing to increased energy efficiency.

The hydraulic disc brakes work with the regenerative braking to ensure effective braking, such as when a high braking demand is requested.

The braking system is computer controlled and blends the regenerative braking with the conventional hydraulic disc brakes to meet any requirements for deceleration. The controller interprets the braking request and uses regenerative braking, conventional hydraulic braking or a combination of both as necessary. Because the controller applies the hydraulic brakes through its high pressure accumulator, you may occasionally hear the motor-driven pump when it recharges the system.

In the event of a controller problem, the brake pedal may be harder to push and the stopping distance may be longer.

Driver Information Centre (DIC) ⇨ 67.

Ride control systems

Traction Control system

The Traction Control system (TC) is a component of the Electronic Stability Control.

TC improves driving stability when necessary, regardless of the type of road surface or tyre grip, by preventing the drive wheels from spinning.

As soon as the drive wheels starts to spin, electric drive unit output is reduced and the wheel spinning the most is braked individually. This considerably improves the driving stability of the vehicle on slippery road surfaces.

TC is operational as soon as the control indicator  extinguishes.

When TC is active  flashes.

Warning

Do not let this special safety feature tempt you into taking risks when driving.

Adapt speed to the road conditions.

Control indicator  ⇨ 64.

Deactivation

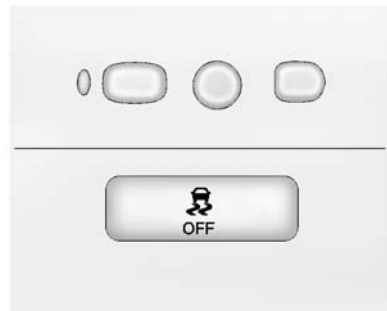

TC can be switched off when spinning of drive wheels is required: Press  button in the overhead console.

Control indicator  illuminates and a message in the Driver Information Centre (DIC) is displayed.

TC is reactivated by pressing the  button again.

TC is also reactivated the next time the ignition is switched on.

Fault

If there is a problem detected with TC, a message is displayed on the DIC. When this message is displayed and  illuminates, the vehicle is safe to drive but the system is not operational. Driving should be adjusted accordingly.

Resetting

If  comes on and stays on, reset the system as follows:

1. Stop the vehicle.
2. Switch the ignition off and wait for 15 seconds.
3. Switch the ignition on.

If  still comes on and stays on, seek the assistance of a workshop.

Caution

Do not repeatedly brake or accelerate heavily when TC is off. The vehicle's driveline could be damaged.

Electronic Stability Control

Electronic Stability Control (ESC) improves driving stability when necessary, regardless of the type of road surface or tyre grip. It also prevents the drive wheels from spinning.

As soon as the vehicle starts to swerve (understeer/oversteer), electric drive unit output is reduced and the wheels are braked individually. This considerably improves the driving stability of the vehicle on slippery road surfaces.

ESC is operational as soon as the control indicator  extinguishes.

When ESC is active,  flashes.

Warning

Do not let this special safety feature tempt you into taking risks when driving.



Adapt speed to the road conditions.

Control indicator  ⇨ 64.

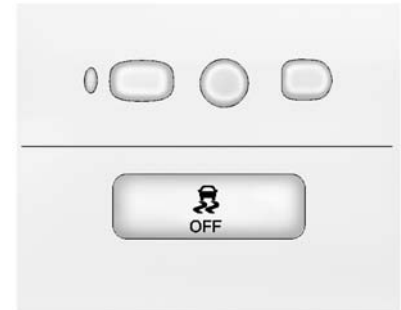
Deactivation



For very high-performance driving, ESC can be deactivated: Press and hold  button in the overhead console

depressed until  and  illuminate and a message in the Driver Information Centre (DIC) is displayed.

ESC is reactivated by pressing the  button again.

If cruise control is being used when ESC activates, cruise control will automatically disengage. Press the cruise control button to re-engage when road conditions allow.

Cruise control ⇨ 118.

Driver Information Centre (DIC) ⇨ 67.

Fault

If there is a problem detected with ESC, a message is displayed on the DIC. When this message is displayed and  illuminates, the vehicle is safe to drive but the system is not operational. Driving should be adjusted accordingly.

Resetting

If  comes on and stays on, reset the system as follows:

1. Stop the vehicle.
2. Switch the ignition off and wait for 15 seconds.
3. Switch the ignition on.

If  still comes on and stays on, seek the assistance of a workshop.

Driver assistance systems

Cruise control

The cruise control lets the vehicle maintain a speed of about 25 mph or more without keeping your foot on the accelerator. Cruise control does not work at speeds below 25 mph.

Do not use the cruise control if it is not advisable to maintain a constant speed.

With the Traction Control system or Electronic Stability Control, the system may begin to limit wheel spin while you are using cruise control. If this happens, the cruise control will automatically disengage.

Traction Control system ⇨ 116.

Electronic Stability Control ⇨ 117.



The cruise control buttons are on the steering wheel.

⏻ (On/Off): Press to turn the cruise control system on and off. An indicator light will turn on or off in the instrument cluster.

⊗ (Cancel): Press to disengage cruise control without erasing the set speed from memory.

RES/+ (Resume/Accel): Move the thumbwheel up to resume to a previously set speed or to accelerate.

SET/- (Set/Coast): Move the thumbwheel down to set a speed and activate cruise control or to make the vehicle decelerate.

Setting cruise control

If the cruise button is on when not in use, it could get bumped and go into cruise when not desired. Keep the cruise control button off when cruise is not being used.

To set a speed:

1. Press **⏻** to turn cruise control on.
2. Get up to the desired speed.
3. Move the thumbwheel down toward **SET/-** and release it. The desired set speed briefly appears in the instrument cluster.
4. Take your foot off the accelerator pedal.

When the brakes are applied, the system deactivates the cruise control.

Resuming a set speed

If the cruise control is set at a desired speed and then the brakes are applied, the cruise control is disengaged without erasing the set speed from memory. Once the vehicle speed is about 25 mph or higher, move the thumbwheel up toward **RES/+** briefly and then release it. The vehicle returns to the previously set speed and stays there.

Increasing speed

If the cruise control system is already activated:

- Move the thumbwheel up toward **RES/+** and hold it until the vehicle accelerates to the desired speed, then release it.
- To increase the speed in small amounts, move the thumbwheel up toward **RES/+** briefly and then release it. Each time this is done, the vehicle goes about 1 mph faster.

Reducing speed

If the cruise control system is already activated:

- Move the thumbwheel toward **SET/** – and hold until the desired lower speed is reached, then release it.
- To slow down in very small amounts, move the thumbwheel toward **SET/–** briefly. Each time this is done, the vehicle goes about 1 mph slower.

Passing another vehicle



Use the accelerator pedal to increase vehicle speed. When you take your foot off the pedal, the vehicle will slow down to the previously set cruise control speed.

Using cruise control on hills

How well the cruise control works on hills depends upon the vehicle speed, load and the steepness of the hills. When going up steep hills, you might have to step on the accelerator pedal to maintain the vehicle speed. When going downhill, you might have to brake or shift to a lower gear to maintain the vehicle speed. When the brakes are applied the cruise control is disengaged.

Switching off cruise control

There are three ways to switch off cruise control:

- Step lightly on the brake pedal; when cruise control disengages, the indicator light will not be lit.
- Press .
- Press  to turn the cruise control system off completely. The previously set cruise control speed cannot be resumed.

Erasing speed memory

The cruise control set speed is erased from memory by pressing  or if the ignition is switched off.

Ultrasonic parking assist

The ultrasonic front and rear parking assist system assists the driver with parking and avoiding objects.

Ultrasonic parking assist operates at speeds less than 5 mph. The sensors on the front and rear bumper detect objects up to 4 ft. in front of the vehicle, 5 ft. behind the vehicle and at least 10 inch off the ground.

System operation

When the vehicle is shifted into **R** the front and rear sensors are automatically turned on. After the vehicle is shifted out of **R**, the rear sensors are turned off and the front sensors stay on until the vehicle is above a speed of 5 mph. For the front park assist system to be active again without shifting into **R**, the park assist button in the overhead console must be pressed.

When the vehicle is in **R**, the system may be active. If the vehicle is in a car wash, the sensors may detect objects in the car wash.

High-toned beeps from the front speakers are for objects detected near the front bumper. Low-toned beeps from the rear speakers are for objects detected near the rear bumper.

The interval between the beeps becomes shorter as the vehicle gets closer to the obstacle. When the distance is less than 12 inch the beeping is a continuous tone for five seconds.

To be detected, objects must be at least 10 inch off the ground and below hatch level. Objects must also be within 4 ft. in front of the vehicle and 5 ft. from the rear bumper. This distance may be less during warmer or humid weather.

Object detection on front and rear

In general, if objects are detected at the same time near both the front and rear bumpers while backing up, the beeps only sound to indicate that objects are close to the rear bumper.

However, if an object comes within 1 ft. of the front bumper while the vehicle is backing up and at the same time there is another object further than 1 ft. from the rear bumper, then the beeps only sound to indicate the object that is closer to the front bumper.

Activation and deactivation

Press **P**  on the overhead console to activate the system.

An LED next to the park assist button lights up.

Press **P**  again to deactivate the system.

The LED next to the park assist button turns off.

After the system has been deactivated, a message in the Driver Information Centre (DIC) is displayed for a short time.

Ultrasonic parking assist defaults to the on setting each time the vehicle is started.

Fault

When the system does not work properly, an error message is displayed in the DIC.

The following conditions could affect the system's performance:

- The driver has disabled the system.
- The ultrasonic sensors are not clean. Keep the vehicle's bumpers free of mud, dirt, snow, ice and slush.
- The park assist sensors are covered by frost or ice. Frost or ice can form around and behind the sensors and may not always be seen; this can occur after washing the vehicle in cold weather. The message may not clear until the frost or ice has melted.

- An object was hanging out of the tailgate during the last drive cycle. Once the object is removed, ultrasonic parking assist will return to normal operation.
- An object or cover is attached to the front of the vehicle.
- The bumper is damaged. Take the vehicle to a workshop to repair the system.
- Other conditions, such as vibrations from a jackhammer or the compression of air brakes on a very large truck, are affecting system performance.

Should the system still do not work properly, seek the assistance of a workshop.

Driver Information Centre (DIC) ⇨ 67.

Important hints for using the ultrasonic parking assist systems

Warning

Under certain circumstances, various reflective surfaces on objects or clothing as well as external noise sources may cause the system to fail to detect obstacles.

Special attention has to be paid to low obstacles which can damage the lower part of the bumper. If such obstacles leave the detection area of the sensors during approach of the vehicle, a continuous warning tone will sound.

Caution

Performance of the ultrasonic parking assist systems can be reduced due to heavy loading.

Special conditions apply if there are taller vehicles involved (e.g. off-road vehicles, mini vans, vans). Object identification in the upper part of these vehicles cannot be guaranteed.

Objects with a very small reflection cross section, like objects of narrow size or soft materials, may not be detected by the system.

Ultrasonic parking assist will not avoid a collision with objects which are out of the detection range of the sensors.

Rear view camera

Warning

The rear view camera system does not display pedestrians, bicyclists, animals or any other object located outside the camera's field of view, below the bumper or under the vehicle.

Do not back the vehicle using only the rear view camera screen or by using the screen during longer, higher speed backing manoeuvres or where there could be cross-traffic. Perceived distances may be different from actual distances.

Failure to use proper care before backing may result in injury, death or vehicle damage. Always check before backing by checking behind and around the vehicle.

The rear view camera system can assist the driver when backing up by displaying a view of the area behind the vehicle.

System operation

When the vehicle is shifted into **R**, the image of the area behind the vehicle appears in the Colour-Info-Display with the message **Check surroundings for safety**. The previous screen displays when the vehicle is shifted out of **R** after approximately 10 seconds.

To cancel the delay, do one of the following:

- Press a button on the infotainment system.
- Shift into **P**.
- Reach a vehicle speed of 5 mph.

Activation and deactivation

To turn the rear view camera system on or off:

1. Shift into **P**.
2. Press the **CONFIG** button on the instrument panel.
3. Select display.
4. Select camera. When a checkmark appears next to camera, then the rear view camera system is on.

Symbols

The navigation system may have a feature that lets the driver view symbols on the navigation screen while using the rear view camera. The ultrasonic parking assist system must not be disabled to use the caution symbols. An error message may be displayed if ultrasonic parking assist has been disabled and the symbols have been turned on.

The symbols appear and may cover an object when viewing the navigation screen when an object is detected by the ultrasonic parking assist system.

To turn the symbols on or off:

1. Shift into **P**.
2. Press the **CONFIG** button on the instrument panel.
3. Select display.
4. Select symbols. When a checkmark appears next to symbols, symbols will appear.

Guidelines

The rear view camera system has a guideline overlay that can help the driver align the vehicle when backing into a parking spot.

To turn the guidelines on or off:

1. Shift into **P**.
2. Press the **CONFIG** button on the instrument panel.
3. Select display.
4. Select guidelines. When a checkmark appears next to guidelines, guidelines will appear.

Rear view camera location

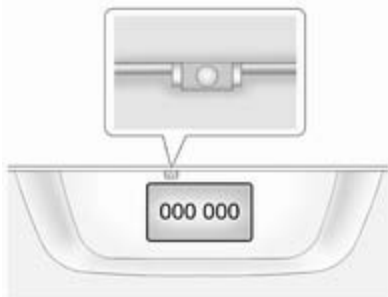

The rear view camera is located above the number plate.

The area displayed by the camera is limited.

It does not display objects that are close to either corner or under the bumper and can vary depending on vehicle orientation or road conditions. The distance of the image that appears on the screen is different from the actual distance.

Fault

The rear view camera system may not work properly or display a clear image if:

- The rear view camera is turned off.
- It is dark.
- The sun or the beam of headlights is shining directly into the camera lens.
- Ice, snow, mud or anything else has built up on the camera lens. Clean the lens, rinse it with water and wipe it with a soft cloth.

- The back of the vehicle was in an accident. The position and mounting angle of the camera can change or the camera can be affected. Be sure to have the camera and its position and mounting angle checked at a workshop.

When the system is not receiving information it requires from other vehicle systems, an error message appears in the Colour-Info-Display.

If any other problem occurs or if a problem persists, seek the assistance of a workshop.

Charging

This section explains the process for charging the vehicle's high voltage battery. Do not allow the vehicle to remain in temperature extremes for long periods without being driven or plugged in. It is recommended that the vehicle be plugged in when temperatures are below 0°C and above 32°C to maximise high voltage battery life.

The charging system may run fans and pumps that result in sounds from the vehicle while it is turned off. Additional unexpected clicking sounds may be caused by the electrical devices used while charging.

While the charge cord is plugged into the vehicle, the vehicle cannot be driven.

Start charge

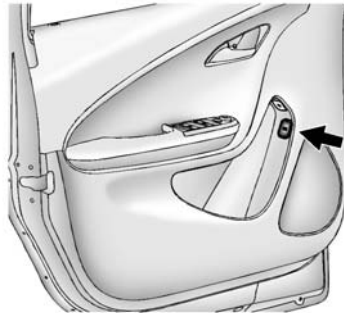

1. The release button of the charge port door is on the driver door inner trim panel. With the vehicle in **P**, press the button for one second and release to open the charge port door. The charge port door can also be opened using the radio remote control.

Radio remote control ⇨ 20.

In cold weather conditions, ice may form around the charge port door. The charge port door may not open on the first attempt. Remove ice from the area and

repeat attempting to open the charge port door.

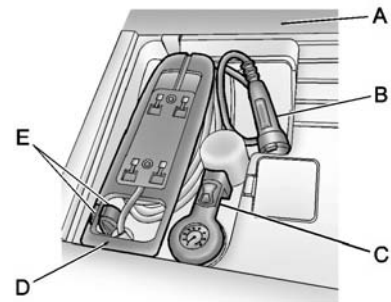

2. Open the tailgate, lift the load support floor covering (**A**) and remove the charge cord (**D**). It is located near the tyre repair kit (**C**). Pull up on the charge cord handle (**D**) to release it from the handle clip (**E**). Lift the charge cord up and rearward to remove it from the vehicle. The vehicle plug (**B**) is stored as shown.
3. Plug the charge cord into the electrical outlet. Verify that the charge cord status indicators are both green. Select the appropriate

charge level. The charge level selection can be done either by using the charging screen in the Colour-Info-Display or by using the charge level button on the charge cord, depending on the car model.

⚠ Warning

Using a charge level that exceeds the electrical circuit or AC outlet capacity may start a fire or damage the electrical circuit. Use the reduced charge level until a qualified electrician inspects your electrical circuit capacity. Use the reduced charge level if the electrical circuit or AC outlet capacity is not known.

Electrical requirements ⇨ 131.

Colour-Info-Display ⇨ 69.

Charge cord ⇨ 128.

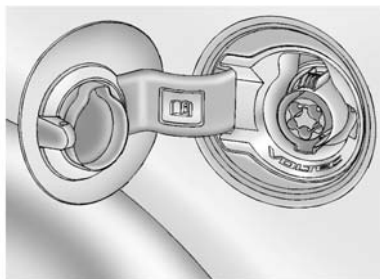

4. Plug in the vehicle plug of the charge cord into the charge port on the vehicle. Verify that the charging status indicator illuminates on top of the instrument panel and a horn chirp occurs.

Charging status ⇨ 127.

5. To arm the charge cord theft alert, lock the vehicle with the radio remote control.

Vehicle personalisation ⇨ 82.

End charge

1. Unlock the vehicle with the radio remote control to disarm the charge cord theft alert.

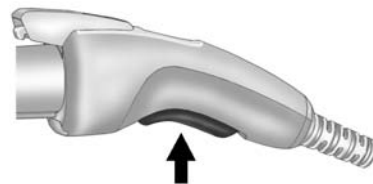

2. Unplug the vehicle plug of the charge cord from the vehicle by squeezing the vehicle plug lever and pull to remove.
3. Close the charge port door by pressing firmly in the centre to latch properly.
4. Unplug the charge cord from the electrical outlet.
5. Before storing the charge cord, have the charge cord face up and wrap the charge cable neatly counterclockwise around the body of the charge cord.

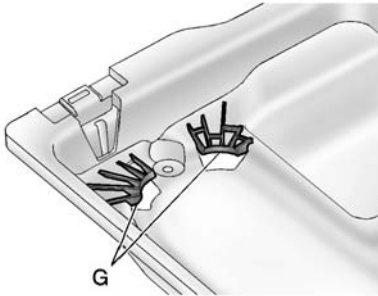
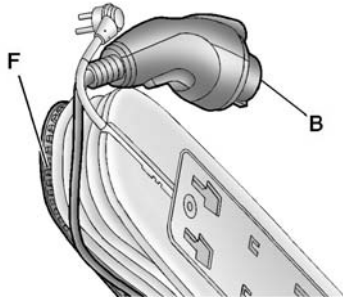

6. Place the charge cord, face down, into the storage compartment with the front edge (F) of the charge cord body under the clips (G) located in the front of the storage

compartment. The vehicle plug (B) should be on the right side of the charge cord.

7. Push the charge cord handle down until it locks into the handle clip at the rear of the storage compartment.

Programmed charging override

To temporarily override a delayed charge event, unplug the charge cord from the charge port and then plug it back in within five seconds. A single horn chirp will sound and charging will begin immediately.

To cancel a temporary override, unplug the charge cord, wait for 10 seconds, and then plug the charge cord back in. A double horn chirp will sound and charging will be delayed.

Programmable charging in the Colour-Info-Display \rightarrow 69.

Charging status





The vehicle has a charging status indicator at the centre of the instrument panel near the windshield. When the vehicle is plugged in and the vehicle power is off, the charging status indicator indicates the following:

- Solid green – One horn chirp: Vehicle is plugged in. Battery is not fully charged. Battery is charging.
- Solid green or long flashing green – Four horn chirps: Insufficient time to fully charge by departure time.

- Long flashing green – Two horn chirps: Vehicle is plugged in. Battery is not fully charged. Battery charging is delayed.
- Short flashing green – No horn chirp: Vehicle is plugged in. Battery is fully charged.
- Solid yellow – No horn chirp: Vehicle is plugged in. It is normal for the charging status indicator to turn yellow for a few seconds after plugging in a compatible charge cord. Otherwise, the charging system has detected a fault and will not charge the battery. Malfunction indicator light ⇨ 62.
- No light signal (upon plug-in) – No horn chirps – Charge cord connection should be checked.
- No light signal (after green or yellow charging status indicator indication observed) – No horn chirps – Charge cord connection should be checked.
Malfunction indicator light ⇨ 62.

If there is no light signal but the horn chirps repeatedly, the electricity was interrupted before charging was complete.

To terminate this alert, do one of the following:

- Unplug the charge cord.
- Press  on the radio remote control.
- Press and hold  on the radio remote control, then press again to stop the panic alarm.
- Press the horn pad.

Vehicle personalisation ⇨ 82.

The system may be thermally conditioning the battery during any of the states above, requiring electrical energy to be transferred to the vehicle.

If the vehicle is plugged in and vehicle power is on, the charging status indicator will be on solid green. The same is true during a remote start if the vehicle is plugged in.

If the vehicle is plugged in and the charging status indicator is off, a charging fault has been detected.

Charge cord

Danger

There is a risk of electric shock that may cause personal injury or death.

Do not use the charge cord if any part of the charge cord is damaged.

Do not open or remove the charge cord cover.

Service by qualified personnel only. Connect the charge cord to a properly grounded outlet with cords that are not damaged.

⚠ Warning

Using the charge cord with a worn or damaged AC outlet may cause burns or start a fire. Periodically, check the AC wall plug and charge cord while the vehicle is charging.

If the AC wall plug feels hot, unplug the charge cord and have the AC outlet replaced by a qualified electrician.

Replace the charge cord if the AC wall plug or cord are damaged. Do not use an AC outlet that is worn or damaged.

⚠ Warning

An extension cord should not be used to charge the vehicle. Use of an extension cord may increase the risk of electric shock or other hazards.

If an extension cord is used because of limited access to 230 volt AC power, use the following safeguards:

The 230 volt AC outlet should be residual current device protected. A residual current device monitors for ground faults, helping reduce the risk of electric shocks.

The extension cord should be:

- Residual current device protected.
- At least 1,5 square mm, 3 conductor.
- Rated for outdoor.

⚠ Warning

Multi outlet power strips, surge protectors or similar devices should not be used with the charge cord.

Use of multi outlet power strips, surge protectors or similar devices may increase the risk of electrical shock and other hazards.

Do not use these types of devices with the charge cord.

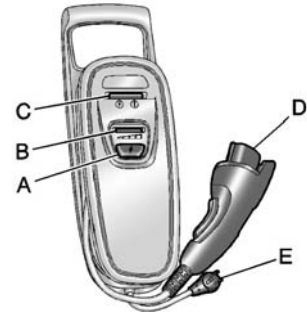

- A = Charge level button
- B = Charge level indicators
- C = Charge cord status indicators
- D = Vehicle plug
- E = Wall plug

A portable charge cord used to charge the vehicle high voltage battery is stored under the load compartment.

The charge cord used to charge the vehicle is a high-powered electrical device. During normal operation, the AC wall plug of the charge cord may feel warm. The AC wall plug must fit tightly into an AC outlet that is in good condition.

Charge cord status indicators

The charge cord status indicators illuminate green or flash red to identify the charge cord status. When both indicators are green, the vehicle can be charged. If any indicators are flashing red, the charge cord will not permit vehicle charging.

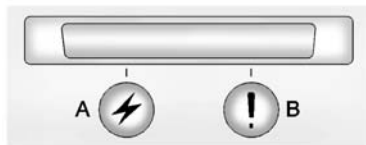

A flashing red AC **(A)** indicates that the AC voltage is out of range.

Flashing red AC **(A)** and fault **(B)** indicate that the AC outlet does not have a proper safety ground. Charging is not permitted for safety reasons. The AC outlet must be repaired or another outlet source should be used.

A flashing red fault **(B)** indicates a charge cord fault. The charge cord will attempt to reset automatically. If the flashing red fault **(B)** continues for more than 30 seconds, unplug the charge cord from the wall to reset. If the fault remains, seek the assistance of a workshop.

Charge level button

⚠ Warning

Using a charge level that exceeds the electrical circuit or AC outlet capacity may start a fire or damage the electrical circuit. Use the reduced charge level until a qualified electrician inspects your electrical circuit capacity. Use the reduced charge level if the electrical circuit or AC outlet capacity is not known.

Note

By choosing a reduced charge level, the charging time is increased.

The charge level selection can be done either by using the charging screen in the Colour-Info-Display or by using the charge level button on the charge cord, depending on the car model.

Colour-Info-Display ⇨ 69.

Two charge levels are available by pressing the charge level button. Select reduced or normal level.

The charge level cannot be changed when the vehicle plug is plugged into the charge port on the vehicle. If the charge level button is pressed while the vehicle plug is plugged into the charge port on the vehicle, the charge level indicators will flash briefly. To change the charge level, unplug the vehicle plug from the charge port on the vehicle and select the desired charge level.

Normal level: This level is recommended. All four charge level indicators will be lit.

Reduced level: Use when the electrical current is limited. Two charge level indicators will be lit.

Vehicle plug

The vehicle plug attaches to the charge port on the vehicle. There is a flashlight built into the vehicle plug that can be used by squeezing the vehicle plug lever. The flashlight will turn off when the connection is complete and the lever is released.

Electrical requirements

Note

Do not use portable or stationary backup generating equipment to charge the vehicle. This may cause damage to the vehicle's charging system. Only charge the vehicle from utility supplied power.

The AC socket must have a grounded, dedicated, 13 ampere or greater, 3 pin wall plug. That means there should be no other major appliances connected to the same circuit. If it is not a dedicated circuit, the current rating of the outlet circuit breaker could be exceeded and cause it to trip or open. The vehicle can be charged in the reduced level mode. Reduced level mode allows a non-dedicated circuit to be used but increases the charging time.

This vehicle is capable of being charged with a variety of standard vehicle charging equipment.

The minimum requirements for circuits used to charge this vehicle are 230 volt and 13 ampere.

Charging equipment with a rating of at least 230 volt / 13 ampere will provide the fastest charging time to recharge the high voltage battery. 230 volt / 32 ampere circuits provide flexibility for future vehicle charging needs. Contact your dealer for more information.

Do not use non-grounded electrical plug adapters.

Fuel

Fuel for petrol engines

Only use unleaded fuel that complies with EN 228.

Usage of fuel with quality, not complying to the Technical Regulations can lead to engine damage and loss of all warranty obligations.

Equivalent standardised fuels with an ethanol content of max. 10 % by volume may be used. In this case only use fuel that complies with E DIN 51626-1.

Use fuel with the recommended octane rating ↗ 183. Use of fuel with too low an octane rating can reduce engine power and torque and slightly increases fuel consumption.

Caution

Use of fuel that does not comply to EN 228 or similar can lead to deposits or engine damage and loss of warranty.

Caution

Use of fuel with too low an octane rating could lead to uncontrolled combustion and engine damage.

Refuelling

⚠ Danger

Before refuelling, switch off ignition and any external heaters with combustion chambers. Switch off any mobile phones. Follow the operating and safety instructions of the filling station when refuelling.

⚠ Danger

Fuel is flammable and explosive. No smoking. No naked flames or sparks.

If you can smell fuel in your vehicle, have the cause of this remedied immediately by a workshop.

Caution

In case of misfuelling, do not switch on ignition.

The fuel system on this vehicle requires a refuelling process to control evaporative emissions. To refuel the vehicle:

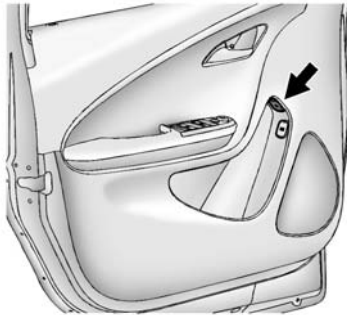

1. Press the fuel door button on the driver door for one second. A message displays on the Driver Information Centre (DIC) to wait.



2. When a message displays in the DIC that the system is ready to be refueled, the fuel door on the

passenger side will unlock. Push the rearward edge of the fuel door in and release to open the door.

3. Turn the fuel cap counterclockwise to remove. While refuelling, hang the fuel cap tether from the hook on the inside of the fuel door. Complete refuelling within 30 minutes of pushing the fuel door button found on the driver side door. If refuelling for more than 30 minutes, push the fuel door button again.
4. After refuelling, reinstall the fuel cap by turning it clockwise until it clicks. Close the fuel door.

Do not top off or overfill the tank and wait a few seconds before removing the nozzle. Clean fuel from painted surfaces as soon as possible.

Fuel filler cap

Only use genuine fuel filler caps.

Fuel consumption - CO₂-Emissions

Fuel

To convert l/100 km into mpg, divide 282 by number of litres/100 km.

- urban: 0.9 l/100 km,
- extra urban: 1.3 l/100 km,
- combined: 1.2 l/100 km.

CO₂

- urban: 21 g/km
- extra urban: 30 g/km
- combined: 27 g/km

General information

For the values specific for your vehicle, refer to the EEC Certificate of Conformity provided with your vehicle or other national registration documents.

The determination of fuel consumption is regulated by directive R (EC) No. 715/2007 (in the newest version respectively).

The specification of CO₂ emission is also a constituent of the directive.

The figures given must not be taken as a guarantee for the actual fuel consumption of a particular vehicle. Furthermore, fuel consumption is dependent on personal driving style as well as road and traffic conditions.

All values are based on the EU base model with standard equipment.

The calculation of fuel consumption takes into account the vehicle's kerb weight, ascertained in accordance with the regulations. Optional equipment may result in slightly higher fuel consumption and CO₂ emission levels and a lower maximum speed.

Towing

General information

The vehicle is neither designed nor intended to tow a trailer or another vehicle.

Vehicle care

General Information	135
Vehicle checks	137
Bulb replacement	143
Electrical system	146
Wheels and tyres	156
Jump starting	168
Towing	172
Appearance care	173

General Information

Accessories and vehicle modifications

We recommend to use genuine parts and accessories and factory approved parts specific for your vehicle type. We cannot assess or guarantee reliability of other products - even if they have a regulatory or otherwise granted approval.

Do not make any modifications to the electrical system, e.g. changes of electronic control units (chip tuning).

Caution

When transporting the vehicle on a train or on a recovery vehicle, the mud flaps might be damaged.

Lifting the vehicle

⚠ Warning

Lifting the vehicle improperly can cause serious injuries to you and others or damage the vehicle.

The vehicle should be lifted just by well-trained staff and in an authorised workshop.

This vehicle can be lifted with a hoist or a service jack. Do not use any other type of jack to lift the vehicle.

Lifting the vehicle with a hoist

The vehicle can be lifted with a hoist at four locations.

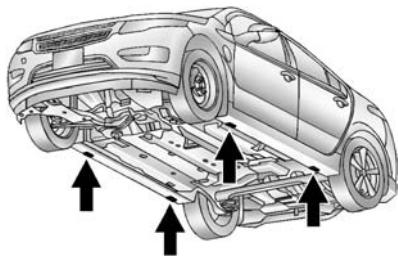

The front lifting points can be accessed from either side of the vehicle, behind the front tyres.

The rear lifting points can be accessed from either side of the vehicle, in front of the rear tyres.

Lifting the vehicle with a service jack

There are four points where the vehicle can be lifted with a service jack.

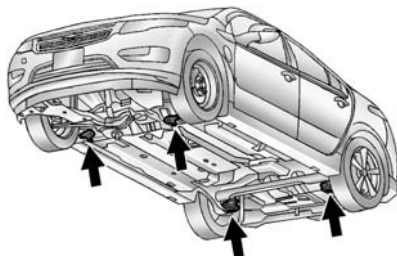

When lifting the vehicle from the rear, place the service jack directly under the spring seat.

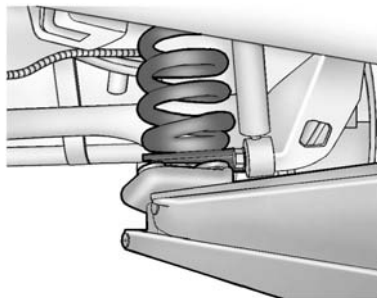

When lifting the vehicle from the front, place the service jack directly under the cradle mount.

Ramps may be needed under the front tyres to provide the necessary clearance for certain service jacks in this location.

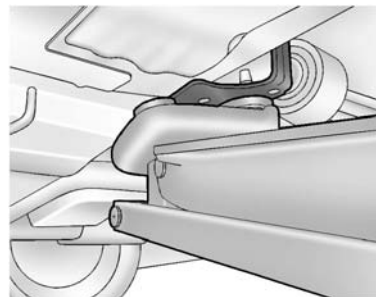

Vehicle checks

Performing work

⚠ Danger

Never try to do your own service on high voltage battery components. You can be injured and the vehicle can be damaged if you try to do your own service work. Service and repair of these high voltage battery components should only be performed by a trained service technician with the proper knowledge and tools. Exposure to high voltage can cause shock, burns, and even death. The high voltage components in the vehicle can only be serviced by technicians with special training.

High voltage components are identified by labels. Do not remove, open, take apart, or modify these components. High voltage cable or wiring has orange covering. Do not probe, tamper with, cut, or modify high voltage cable or wiring.

⚠ Warning

Only perform engine compartment checks when the ignition is off. The cooling fan may start operating even if the ignition is off.

Bonnet

Opening

1. Turn off the vehicle before opening the bonnet. If the vehicle is on, the engine will start when the bonnet is opened.
Electric vehicle operation modes
↪ 106.

2. Pull the release handle which is located below the instrument panel to the left of the steering wheel.

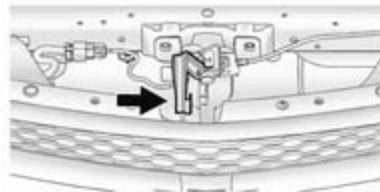

3. Push the safety catch in the engine compartment to the right and open the bonnet.
4. Release the bonnet prop rod from its retainer above the radiator support and place it securely into the slotted retainer in the bonnet.

Closing

Before closing the bonnet, press the bonnet prop in its retainer. Lower the bonnet and allow it to drop into the catch. Check that the bonnet is engaged.

Engine oil

Check the engine oil manually on a regular basis to prevent damage to the engine. Ensure that the correct specification of oil is used.

Recommended fluids and lubricants ⇨ 177.

Check with the vehicle on a level surface. The engine must be at operating temperature and switched off for at least 5 minutes.

Pull out the dipstick, wipe it clean, insert it to the stop on the handle, pull out and read the engine oil level.

Insert dipstick to the stop on the handle and make half a turn.



If the engine oil level is below the cross-hatched area at the tip of the dipstick, top up engine oil.

Recheck the level.

We recommend the use of the same grade of engine oil that was used at last change.

The engine oil level must not exceed the cross-hatched area on the dipstick.

Caution

Overfilled engine oil must be drained or suctioned out.

Capacities ⇨ 185, Engine oil quality/viscosity ⇨ 177.

Fit the cap on straight and tighten it.

Cooling system

The vehicle has three different cooling systems.

Check regularly the coolant level of the respective cooling systems and have the cause of a possible coolant loss remedied by a workshop.

Caution

Make sure that you never run the vehicle with insufficient coolant.

Too low a coolant level can cause damage to the vehicle.

Engine cooling system

The coolant reservoir is located on the passenger side of the engine compartment.

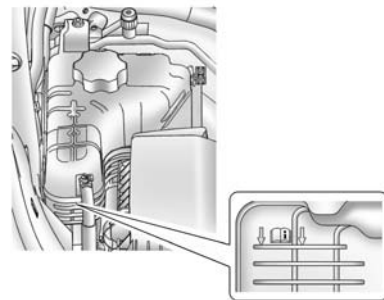

The coolant provides freeze protection down to approx. -28°C .

Caution

Only use approved antifreeze.

If the engine cooling system is cold, the coolant level should be above the filling line mark. Top up if the level is low.

Warning

Allow the engine to cool before opening the cap. Carefully open the cap, relieving the pressure slowly.

To top up use a 1:1 mixture of approved coolant concentrate mixed with tap water. Install the cap tightly.

High voltage battery cooling system

Danger

The high voltage battery coolant may only be serviced by a qualified technician.

Improper handling could cause serious injuries or death.

The high voltage battery coolant reservoir is located on the passenger side of the engine compartment.

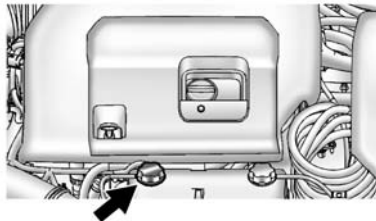

Check to see if coolant is visible in the high voltage battery coolant reservoir. If coolant is visible but the coolant level is below the cold fill line, there could be a leak in the cooling system.

The high voltage battery coolant reservoir in the vehicle is filled with a 1:1 mixture of approved coolant concentrate and deionised water.

Power electronics and charger modules cooling system

Danger

The power electronics and charger modules coolant may only be serviced by a qualified technician.

Improper handling could cause serious injuries or death.

The power electronics and charger modules are cooled using the same coolant loop.

The power electronics and charger modules coolant reservoir is located on the driver side of the engine compartment.



Check to see if coolant is visible in the power electronics and charger modules coolant reservoir. If coolant is visible but the coolant level is below the cold fill line, there could be a leak in the cooling system.

The power electronics and charger modules cooling system in the vehicle is filled with a 1:1 mixture of approved coolant concentrate and deionised water.

Engine overheating

The vehicle has an indicator to warn of engine overheating.

If the decision is made not to lift the bonnet when this warning appears, get service help right away.

If the decision is made to lift the bonnet, make sure the vehicle is parked on a level surface.

Then check to see if the engine cooling fans are running. If the engine is overheating, the fans should be running. If they are not, do not continue to run the vehicle and have the vehicle serviced.

Washer fluid

An error message will appear on the Driver Information Centre (DIC) when the fluid level is low.

Fill with clean water mixed with a suitable quantity of washer fluid which contains antifreeze. For the correct mixing ratio, refer to the washer fluid container.

Caution

Only washer fluid with a sufficient antifreeze concentration provides protection at low temperatures or a sudden drop in temperature.

Brakes

In the event of minimum thickness of the brake lining, a squealing noise sounds during braking.

Continued driving is possible but have the brake lining replaced as soon as possible.

Once new brake linings are installed, do not brake unnecessarily hard for the first few journeys.

Brake fluid

⚠ Warning

Brake fluid is poisonous and corrosive. Avoid contact with eyes, skin, fabrics and painted surfaces.

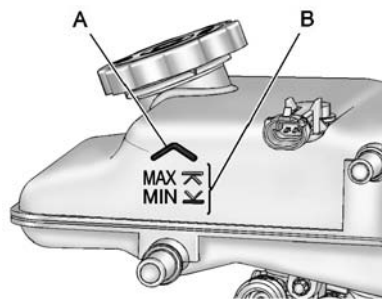

With the vehicle not running for at least one minute, the maximum fluid level (**A**) is at the top of the reservoir body. With the vehicle running, the fluid level should be in the proper operating range (**B**) between the **MIN** and **MAX** marks. If it is not, have the brake hydraulic system checked to see if there is a leak.

After work is done on the brake hydraulic system, make sure the level, with the vehicle running, is in the proper operating range (**B**) between the **MIN** and **MAX** marks.

Only use high-performance brake fluid approved for the vehicle, consult a workshop.

Brake fluid ⇨ 177.

Battery

⚠ Danger

Only a trained service technician with the proper knowledge and tools may inspect, test or replace the high voltage battery.

Seek the assistance of a workshop if the high voltage battery needs service.

This vehicle has a high voltage battery and a standard 12 volt battery. If the vehicle is in a crash, the sensing system may shut down the high voltage system. When this occurs, the high voltage battery is disconnected and the vehicle will not start. A service message will be displayed in the Driver Information Centre (DIC).

Before the vehicle can be operated again, it must be serviced at a workshop.

A vehicle cover, which can reduce sun loading on the vehicle and improve high voltage battery life, is available from your Vauxhall Ampera Authorised Repairer.

The Vauxhall Ampera Authorised Repairer has information on how to recycle the high voltage battery.

Keep the vehicle plugged in, even when fully charged, to keep the high voltage battery temperature ready for the next drive. This is important when outside temperatures are extremely hot or cold.

Refer to the replacement number shown on the original battery label when a new 12 volt battery is needed. The vehicle has an Absorbed Glass Mat (AGM) 12 volt battery. Installation of a standard 12 volt battery will result in reduced 12 volt battery life. When using a 12 volt battery charger on the 12 volt AGM battery, some chargers have an AGM battery setting on the

charger. If available, use the AGM setting on the charger, to limit charge voltage to 14,8 volts.



Batteries do not belong in household waste. They must be disposed of at an appropriate recycling collection point.

Vehicle storage

Warning

Batteries have acid that can burn you and gas that can explode. You can be badly hurt if you are not careful.

Remove the 12 volt battery black, negative (-) cable from the battery to keep the 12 volt battery from running down or use a battery trickle charger.

In addition, to avoid potential damage to the high voltage battery, perform the following recommended steps:

- Store the high voltage battery with 1/2 charge or less.
- Always store the vehicle in an environment between -10°C and 30°C .
- Vehicle storage at extreme temperatures can cause damage to the high voltage battery.

Remember to reconnect the 12 volt battery when ready to drive the vehicle.

Wiper blade replacement

Wiper blades on the windscreen

To replace the windscreen wiper blade:

1. Lift the wiper arm.

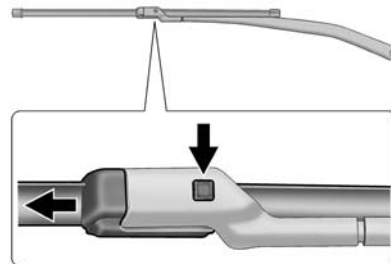

2. Press the button in the middle of the wiper arm connector and pull the wiper blade away from the arm connector.
3. Remove the wiper blade.

Headlight aiming

Headlight aim has been preset and should need no further adjustment. When driving in countries where the traffic drives on the opposite side of the road, it is not necessary to adjust the headlights.

If the vehicle is damaged in a crash, the headlight aim may be affected. If adjustment to the headlights is necessary, seek the assistance of a workshop.

Bulb replacement

Switch off the ignition and switch off the relevant switch or close the doors. Only hold a new bulb at the base! Do not touch the bulb glass with bare hands.

Use only the same bulb type for replacement.

Replace headlight bulbs from within the engine compartment.

Halogen bulbs

Warning

Halogen bulbs have pressurised gas inside and can burst if you drop or scratch the bulb. You or others could be injured. Be sure to read and follow the instructions on the bulb package.

Halogen headlights

Driver side headlights

To replace the high/low-beam headlight:

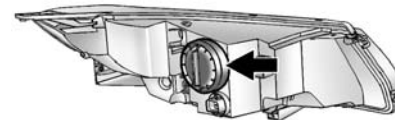

1. Remove the cover from the back of the headlight assembly by turning it counterclockwise.
2. Remove the bulb socket from the headlight assembly by turning it counterclockwise.
3. Remove the bulb from the socket.
4. Install the new bulb in the socket.
5. Install the bulb socket by turning it clockwise.
6. Install the cover in the back of the headlight assembly by turning it clockwise.

Passenger side headlights

To replace the high/low-beam headlight:

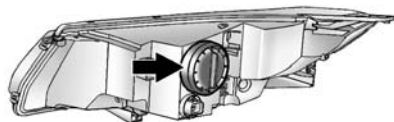

1. Remove the cover from the back of the headlight assembly by turning it counterclockwise.
2. Remove the bulb from the headlight assembly by turning it counterclockwise.
3. Disconnect the bulb from the wiring harness connector.
4. Install the new bulb in the headlight assembly by turning it clockwise.
5. Reconnect the wiring harness connector.
6. Install the cover on the back of the headlight assembly by turning it clockwise.

Tail lights

Have the lights replaced by a workshop.

Side turn signal lights

Have bulbs replaced by a workshop.

Reversing light

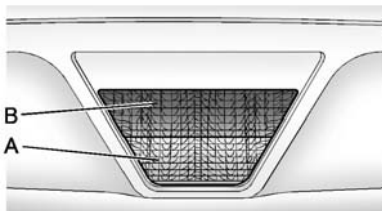

A = Reversing light
B = Rear fog light

1. Remove the three inboard screws from the aero panel located under the rear fascia.
2. Push up on the aero panel to locate the reversing light bulb socket (**A**).

3. Turn the bulb socket (**A**) counterclockwise to remove it from the bulb assembly.
4. Pull the bulb from the bulb socket.
5. Push a new bulb straight into the bulb socket.
6. Reinstall the bulb socket by lining up the tabs and turn it clockwise to lock it into place.
7. Replace the three inboard screws into the aero panel.

Number plate light

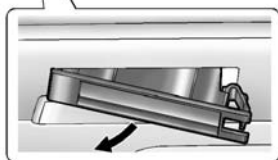

1. Press the spring clip on the right end of the light assembly to the left to unlock the light assembly.
2. Pull down on the light assembly to remove it from the fascia.

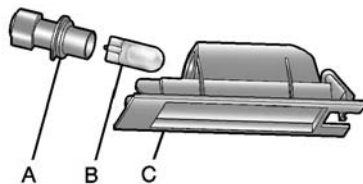

3. Turn the bulb socket (A) counterclockwise to remove it from the light assembly (C).
4. Pull the bulb (B) straight out of the bulb socket (A).
5. Push the replacement bulb straight into the bulb socket (A) and turn the bulb socket (A) clockwise to install it into the light assembly (C).
6. Reinstall the light assembly (C) into the fascia by inserting the left side first.
7. Push the spring clip side into place.

Rear fog light

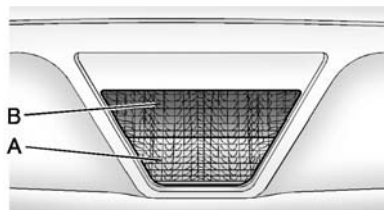

Reversing light / Rear fog light assembly - Outside view

- A = Reversing light
B = Rear fog light

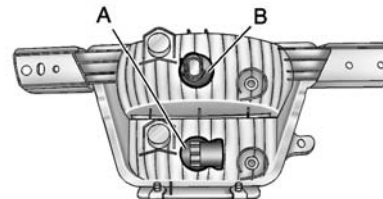

Reversing light / Rear fog light assembly - Backside view

1. Remove the three inboard screws from the aero panel located under the rear fascia.
2. Push up on the aero panel to locate the rear fog light bulb socket (B).
3. Turn the bulb socket (B) counterclockwise to remove it from the bulb assembly.
4. Pull the bulb from the bulb socket.
5. Push a new bulb straight into the bulb socket.

6. Reinstall the bulb socket by lining up the tabs and turn it clockwise to lock it into place.
7. Replace the three inboard screws into the aero panel.

Electrical system

High voltage devices and wiring

Warning

Exposure to high voltage can cause shock, burns, and even death. The high voltage components in the vehicle can only be serviced by technicians with special training.

High voltage components are identified by labels. Do not remove, open, take apart, or modify these components. High voltage cable or wiring has orange covering. Do not probe, tamper with, cut, or modify high voltage cable or wiring.

Electrical system overload

The vehicle has fuses and circuit breakers to protect against an electrical system overload.

When the current electrical load is too heavy, the circuit breaker opens and closes, protecting the circuit until the current load returns to normal or the problem is fixed. This greatly reduces the chance of circuit overload and fire caused by electrical problems.

Fuses and circuit breakers protect the following in the vehicle:

- Headlight wiring
- Windscreen wiper motor
- Power windows and other power accessories

Replace a bad fuse with a new one of the identical size and rating. If there is a problem on the road and a fuse needs to be replaced, the same amperage fuse can be borrowed. Choose some feature of the vehicle that is not needed to use and replace it as soon as possible.

Headlight wiring

An electrical overload may cause the lights to go on and off or in some cases to remain off. Have the headlight wiring checked right away if the lights go on and off or remain off.

Windscreen wipers

If the wiper motor overheats due to heavy snow or ice, the windscreen wipers will stop until the motor cools and the wiper control is turned off. After removal of the blockage, the wiper motor will restart when the control is then moved to the desired operating position.

Although the circuit is protected from electrical overload, overload due to heavy snow or ice, may cause wiper linkage damage.

Always clear ice and heavy snow from the windscreen before using the windscreen wipers. If the overload is caused by an electrical problem and not snow or ice, be sure to get it fixed.

Fuses

Data on the replacement fuse must match the data on the defective fuse.

There are four fuse boxes in the vehicle:

- in the front left of the engine compartment,
- on the right end side and the left end side of the instrument panel,
- behind a cover on the left side of the load compartment.

Before replacing a fuse, turn off the respective switch and the ignition.

A blown fuse can be recognised by its melted wire. Do not replace the fuse until the cause of the fault has been remedied.

Some functions are protected by several fuses.

Fuses may also be inserted without existence of a function.

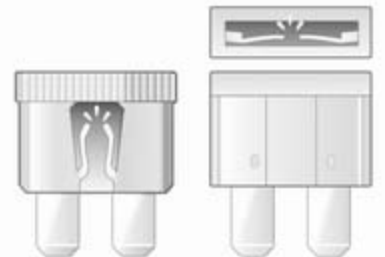

30040



30041

Fuse extractor

A fuse extractor may be located in the fuse box in the engine compartment.

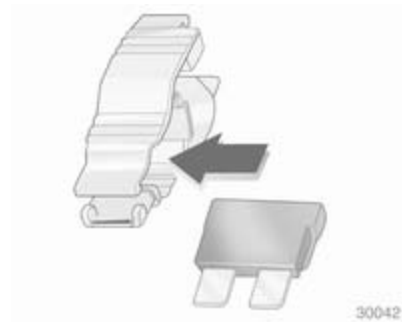
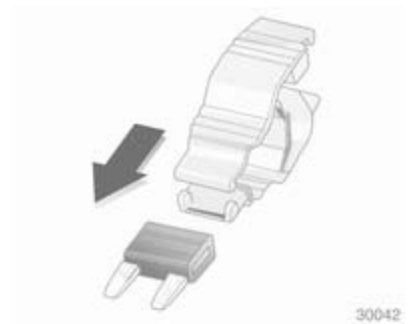

Place the fuse extractor on the various types of fuse from the top or side, and withdraw fuse.

Engine compartment fuse box

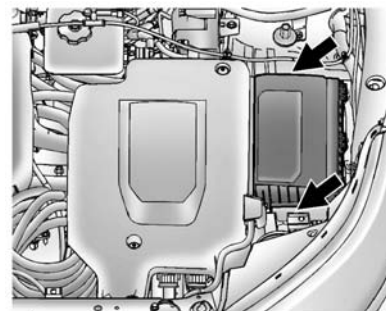

The fuse box is in the front left of the engine compartment.

To open the fuse block cover, press the clips at the front and back and rotate the cover up to the side.



Mini fuses Usage

1	Engine control module – switched power
2	Emissions
3	–
4	Ignition coils / Injectors
5	Column lock
6a	–
6b	–
7	–
8	–
9	Heated mirrors
10	Air conditioning control module
11	Traction power inverter module – Battery
12	–
13	Cabin heater pump and valve

Mini fuses Usage

14	Theft deterrent — Power sounder
15	Traction power inverter module and transmission control module — Battery
17	Engine control module — Battery
22	Left high-beam headlight
24	–
25	–
26	Theft deterrent — Horn
31	–
32	Run/Crank — Sensing diagnostic module, instrument cluster, passenger airbag display, headlight level switch, automatic dimming inside rearview mirror

Mini fuses Usage

33	Run/Crank — Vehicle integration control module
34	Vehicle integration control module — Battery
35	—
36	Power electronics coolant pump
37	Cabin heater control module
38	Rechargeable energy storage system (high voltage battery) coolant pump
39	Rechargeable energy storage system (high voltage battery) control module
40	Front windscreen washer
41	Right high-beam headlight

Mini fuses Usage

46	—
47	—
49	—
50	Run/Crank — Rear view camera, accessory power module, tyre pressure monitor, headlight levelling motors
51	Run/Crank for ABS/ Rechargeable energy storage system (high voltage battery)
52	Engine control module/ transmission control module — Run/Crank

Mini fuses Usage

53	Traction power inverter module — Run/Crank
54	Run/Crank — Fuel system control module, air conditioning control module, on-board charger

J-case fuses Usage

16	—
18	—
19	Front power window
20	—
21	Antilock brake system electronic control unit
23	Charge port door
27	—
28	—
29	—

J-case fuses Usage

30	Antilock brake system motor
42	Right cooling fan
43	Front wipers
44	Charger
45	–
48	Left cooling fan

Mini relays Usage

3	Powertrain
4	Heated mirrors
7	–
9	–
11	–
12	–
13	–
14	Run/Crank

Micro relays Usage

1	–
2	–
6	–
8	–
10	–

Ultra-micro relays Usage

5	Charge port door
---	------------------

After having changed defective fuses, close the fuse box cover and press until it engages.

If the fuse box cover is not closed correctly, malfunctions may occur.

Instrument panel fuse box**Instrument panel fuse box on the left side end**

The left instrument panel fuse box is located on the left side end of the instrument panel. To access the fuses, open the fuse panel door by pulling out.

A fuse puller is located in the engine compartment fuse box.



Fuses Usage

- F1** Power outlet – Top of IP storage bin
- F2** Radio
- F3** Instrument cluster (left hand drive)
- F4** Infotainment display
- F5** Heating, ventilation & air conditioning/ Integrated centre stack switches
- F6** Airbag (Sensing diagnostic module)
- F7** Left primary data link connector (left hand drive), Left secondary data link connector (right hand drive)
- F8** Column lock (left hand drive)
- F9** Hands-free phone

Fuses Usage

- F10** Body control module 1/Body control module electronics/ Remote entry/Power moding/ Centre high- mounted stoplight/ Number plate lights/Left daytime running light/Left position lights/ Tailgate release relay control/ Washer pump relay control/Switch indicator lights
- F11** Body control module 4/Left headlight
- F12** Blower (left hand drive)
- F13** –
- F14** –
- F15** Power outlet (Inside floor console/Rear of floor console)
- F16** –
- F17** –
- F18** –

Relays Usage

R1	Retained accessory power relay for power outlets
R2	–
R3	–
R4	Deadbolt (left hand drive), Child lockout (right hand drive)

Diodes Usage

DIODE	–
--------------	---

To reinstall the door, insert the bottom tab first, then push the door back into its original location.

Instrument panel fuse box on the right side end

The right instrument panel fuse box is located on the right side end of the instrument panel. To access the fuses, open the fuse panel door by pulling out.

A fuse puller is located in the engine compartment fuse block.



Fuses Usage

F1	Steering wheel switch backlighting
F2	Column lock (right hand drive)
F3	Cluster (right hand drive)
F4	Body control module 3/Right headlight
F5	Body control module 2/Body control module electronics/ Tail light/Right daytime running light/ Shifter lock/ Switch backlighting/Rear fog light
F6	Body control module 5/ Retained accessory power relay control/Right front turn signal light/Left rear stop and turn signal light/Right position lights/Remote PRNDL
F7	Body control module 6/Map lights/Courtesy lights/ Reversing lights

Fuses Usage

F8	Body control module 7/Left front turn signal/Right rear stop and turn signal light/Child security lock relay control
F9	Body control module 8/Locks
F10	Right secondary data link connector (left hand drive), Right primary data link connector (right hand drive)
F11	Intrusion and inclination sensor
F12	Blower motor (left hand drive)
F13	–
F14	–
F15	–
F16	–
F17	–
F18	–

Relays Usage

R1	–
R2	–
R3	–
R4	Deadbolt (right hand drive), Child lockout (left hand drive)

Diodes Usage

DIODE	–
--------------	---

To reinstall the door, insert the bottom tab first, then push the door back into its original location.

Load compartment fuse box

The fuse box is on the left side of the load compartment behind a cover. Remove the cover.

A fuse puller is located in the engine compartment fuse box.



Fuses Usage

F1	–
F2	Fuel system control module
F3	Passive start/ Passive entry module
F4	Heated seats
F5	Driver door switches (Outside rearview mirror/ Charge port door release/ Refuel request/Driver window switch)
F6	Fuel (Diurnal valve and evap. leak check module)
F7	Accessory power module cooling fan
F8	Amplifier
F9	Digital audio broadcast
F10	Regulated voltage control/ Ultrasonic front and rear parking assist
F11	Horn

Fuses Usage

F12	Rear power windows
F13	Electrical parking brake
F14	Rear defog (Upper grid)
F15	–
F16	Tailgate release
F17	–
F18	–

Relays Usage

R1	Rear defog (Upper grid)
R2	Tailgate release
R3	–
R4	–
R5	–
R6	–
R7	Horn
R8	Horn

Diodes**Usage**

DIODE	–
--------------	---

Wheels and tyres

Tyre condition, wheel condition

Drive over edges slowly and at right angles if possible. Driving over sharp edges can cause tyre and wheel damage. Do not trap tyres on the kerb when parking.

Regularly check the wheels for damage. Seek the assistance of a workshop in the event of damage or unusual wear.

Tyres

Directional tyres

Fit directional tyres such that they roll in the direction of travel. The rolling direction is indicated by a symbol (e.g. an arrow) on the sidewall.

The following applies to tyres fitted opposing the rolling direction:

- Driveability may be affected. Have the defective tyre renewed or repaired as soon as possible.
- Do not drive faster than 50 mph.
- Drive particularly carefully on wet and snow-covered road surfaces.

Winter tyres

Winter tyres improve driving safety at temperatures below 7 °C and should therefore be fitted on all wheels.

Tyres of size 205/60R16 are permitted as winter tyres.

Tyres of size 215/55R17 and 225/45R18 are not permitted as winter tyres.

In accordance with country-specific regulations, affix the speed sticker in the driver's field of view.

Tyre designations

E.g. 215/60 R 16 95 H

- 215** = Tyre width, mm
- 60** = Cross-section ratio (tyre height to tyre width), %
- R** = Belt type: Radial
- RF** = Type: RunFlat
- 16** = Wheel diameter, inches
- 95** = Load index e.g. 95 is equivalent to 690 kg
- H** = Speed code letter

Speed code letter:

- Q** = up to 100 mph
- S** = up to 112 mph
- T** = up to 118 mph
- H** = up to 130 mph
- V** = up to 150 mph
- W** = up to 168 mph

Tyre pressure

Although your vehicle has an integrated tyre pressure monitoring system, you should check the tyre pressure of your cold tyres at least every 14 days and before any long journey.

Unscrew the valve cap.

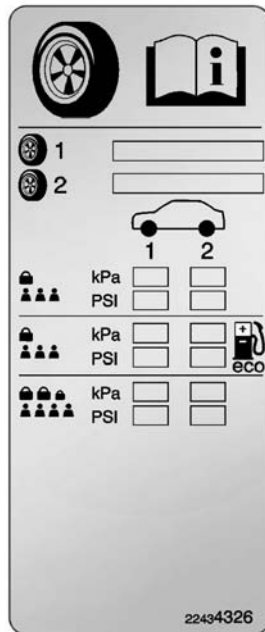

The tyre and loading information label on the front left centre B-pillar indicates the original equipment tyres and the correct cold tyre inflation pressures.

Additional to that: See tyre pressure ⇨ 185.

The tyre pressure data refers to cold tyres. It applies to summer and winter tyres.

The ECO tyre pressure serves to achieve the smallest amount of fuel consumption possible.

Incorrect tyre pressures will impair safety, vehicle handling, comfort and fuel economy and will increase tyre wear.

Warning

If the pressure is too low, this can result in considerable tyre warm-up and internal damage, leading to tread separation and even to tyre blow-out at high speeds.

If the tyre pressure shall be reduced or increased on a vehicle with tyre pressure monitoring system, switch off ignition.

Tyre pressure monitoring system

The tyre pressure monitor system uses radio and sensor technology to check tyre pressure levels. The tyre pressure monitoring system sensors monitor the air pressure in your vehicle's tyres and transmit tyre pressure readings to a receiver located in the vehicle.

When the low tyre pressure telltale illuminates, you should stop and check your tyres as soon as possible, and inflate them to the proper pressure. Driving on a significantly under-inflated tyre causes the tyre to overheat and can lead to tyre failure. Under-inflation also reduces fuel efficiency and tyre tread life, and may affect the vehicle's handling and stopping ability.

Please note that the tyre pressure monitoring system is not a substitute for proper tyre maintenance and it is the driver's responsibility to maintain correct tyre pressure, even if under-inflation has not reached the level to trigger illumination of the tyre pressure monitoring system low tyre pressure telltale.

The tyre pressure monitoring system malfunction indicator is combined with the low tyre pressure telltale. When the system detects a malfunction, the telltale will flash for approximately one minute and then remain continuously illuminated. This sequence will continue upon subsequent vehicle start-ups as long as the malfunction exists.

When the malfunction indicator is illuminated, the system may not be able to detect or signal low tyre pressure as intended. Tyre pressure monitoring system malfunctions may occur for a variety of reasons, including the installation of replacement or alternate tyres or wheels on the vehicle that prevent the tyre pressure monitoring system from

functioning properly. Always check the tyre pressure monitoring system malfunction telltale after replacing one or more tyres or wheels on your vehicle to ensure that the replacement or alternate tyres and wheels allow the tyre pressure monitoring system to continue to function properly.

Tyre pressure monitor operation

When a low tyre pressure condition is detected,  illuminates.

If  comes on, stop as soon as possible and inflate the tyres as recommended in this manual.

Tyre pressures ⇨ 185.

A message to check the pressure in a specific tyre displays in the Driver Information Centre (DIC).  and the DIC warning message come on at each drive cycle until the tyres are inflated to the correct inflation pressure. Using the DIC, tyre pressure levels can be viewed.

Control indicator  ⇨ 65.

DIC ⇨ 67.

 may come on in cool weather when the vehicle is first started, and then turn off as the vehicle is driven. This could be an early indicator that the air pressure is getting low and needs to be inflated to the proper pressure.

The tyre and loading information label on the front left centre B-pillar indicates the original equipment tyres and the correct cold tyre inflation pressures.

Additional to that: See tyre pressure ⇨ 185.

The tyre pressure monitoring system can warn about a low tyre pressure condition but it does not replace normal tyre maintenance.

The use of commercially available liquid tyre repair kits can impair the function of the system. Factory approved repair kits can be used.

Adaptive threshold function

The tyre pressure monitoring system automatically detects if the vehicle is driven with a tyre pressure appropriate for a load of up to 3 people or for a full load.

If the tyre pressure shall be reduced, switch off ignition before reducing.

Sensor matching process - Manual

Each tyre pressure monitoring system sensor has a unique identification code. The identification code needs to be matched to a new tyre/wheel position after rotating the vehicle's tyres or replacing one or more of the sensors. Also, the tyre pressure monitoring system sensor matching process should be performed after replacing a spare tyre with a road tyre containing the tyre pressure monitoring system sensor.

(!) and the DIC message should go off at the next drive cycle. The sensors are matched to the tyre/wheel positions, using a tyre pressure monitoring system relearn tool, in the following order: left front tyre, right front tyre, right rear tyre and left rear tyre. Ask your Authorised Vauxhall Ampera Repairer for service or to purchase a relearn tool.

There are two minutes to match the first tyre/wheel position and five minutes overall to match all four tyre/wheel positions. If it takes longer, the matching process stops and must be restarted.

Follow the tyre pressure monitoring system sensor matching process:

1. Set the parking brake.
2. Switch the ignition on and place the vehicle in **P**.

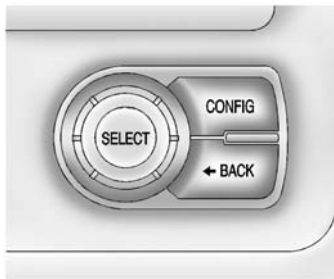

3. If the DIC display is minimised, press the **SELECT** knob to maximise it.

4. Use the **SELECT** knob to scroll to the tyre pressure display screen.
5. Press and hold the **SELECT** knob for five seconds to begin the sensor matching process.

A message displays confirming to begin the process.

6. Use the **SELECT** knob to select **YES** with the highlighted selection and press the **SELECT** knob again to confirm the selection.

The horn sounds twice to signal the receiver is in relearn mode and a message displays on the DIC screen.

7. Start with the left front tyre.
8. Place the relearn tool against the tyre sidewall, near the valve stem. Then press the button to activate the tyre pressure monitoring system sensor.

A horn chirp confirms that the sensor identification code has been matched to this tyre and wheel position.

9. Proceed to the right front tyre and repeat the procedure in Step 8.

10. Proceed to the right rear tyre and repeat the procedure in Step 8.
11. Proceed to the left rear tyre and repeat the procedure in Step 8. The horn sounds two times to indicate the sensor identification code has been matched to the left rear tyre and the tyre pressure monitoring system sensor matching process is no longer active. The message on the DIC display screen goes off.
12. Switch off the ignition.
13. Set all four tyres to the recommended air pressure level. Tyre and loading information label ↻ 156.
Tyre pressure ↻ 185.

Sensor matching process - Auto learn function

Each tyre pressure monitoring system sensor has a unique identification code. The identification code needs to be matched to a new tyre/wheel position after rotating the vehicle's tyres or replacing one or more of the sensors. Also, the tyre

pressure monitoring system sensor matching process should be performed after replacing a spare tyre with a road tyre containing the tyre pressure monitoring system sensor.

After changing a tyre, the vehicle has to be stationary for approx.

20 minutes, before the system recalculates. The following relearn process takes up to 10 minutes of driving with a speed of minimum 12 mph. In this case -- can be displayed or pressure values can swap in the DIC.

If problems occur during the relearn process a warning message is displayed in the DIC.

Note

Vehicles equipped with the auto learn function do not allow manual sensor matching.

Fault

The tyre pressure monitoring system will not work properly if one or more of the sensors are missing or inoperable.

When the system detects a malfunction, (U) flashes for about one minute and then stays on for the remainder of the vehicle on/off cycle. A DIC warning message also displays. (U) and the DIC warning message come on at each vehicle on/off cycle until the problem is corrected. Some of the conditions that can cause these to come on are:

- The tyre pressure monitoring system sensor matching process was started but not completed or not completed successfully after rotating the tyres. The DIC message and (U) should go off once the tyre pressure monitoring system sensor matching process is performed successfully.
- One or more tyre pressure monitoring system sensors are missing or damaged. The DIC message and (U) should go off when the sensors are installed and the sensor matching process is performed successfully. Seek the assistance of a workshop.

- Replacement tyres or wheels do not match the original equipment tyres or wheels. Tyres and wheels other than those recommended could prevent the tyre pressure monitoring system from functioning properly.
- Operating electronic devices or being near facilities using radio wave frequencies similar to the tyre pressure monitoring system could cause the tyre pressure monitoring system sensors to malfunction.

If the tyre pressure monitoring system is not working properly, it cannot detect or signal a low tyre condition. Seek the assistance of a workshop.

Tread depth

Check tread depth at regular intervals.

Tyres should be replaced for safety reasons at a tread depth of 2-3 mm (4 mm for winter tyres).



The legally permissible minimum tread depth (1.6 mm) has been reached when the tread has worn down as far as one of the tread wear indicators (TWI). Their position is indicated by markings on the sidewall.

If there is more wear at the front than the rear, swap round front wheels and rear wheels periodically. Ensure that the direction of rotation of the wheels is the same as before.

Tyres age, even if they are not used. We recommend tyre replacement every 6 years.

Changing tyre and wheel size

If tyres of a different size than those fitted at the factory are used, it may be necessary to reprogramme the speedometer as well as the nominal tyre pressure and make other vehicle modifications.

Ensure that the direction of rotation of the wheels is the same as before and according to tyre manufacturer instructions.

After converting to a different tyre size, have the label with tyre pressures replaced.

Warning

Use of unsuitable tyres or wheels may lead to accidents and will invalidate the vehicle type approval.

Wheel covers

Wheel covers and tyres that are factory approved for the respective vehicle and comply with all of the relevant wheel and tyre combination requirements must be used.

If the wheel covers and tyres used are not factory approved, the tyres must not have a rim protection ridge.

Wheel covers must not impair brake cooling.

⚠ Warning

Use of unsuitable tyres or wheel covers could lead to sudden pressure loss and thereby accidents.

Tyre chains

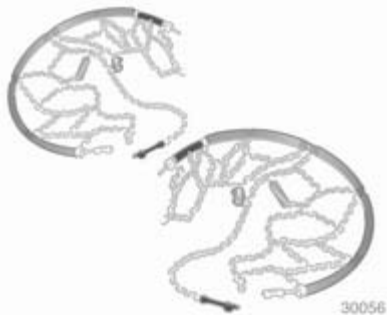

Tyre chains are only permitted on the front wheels.

Always use fine mesh chains that add no more than 10 mm to the tyre tread and the inboard sides (including chain lock).

⚠ Warning

Damage may lead to tyre blowout.

Tyre chains are only permitted on tyres of size 205/60R16.

Tyre chains are not permitted on tyres of size 215/55R17 and 225/45R18.

Tyre repair kit

This vehicle has a tyre repair kit, consequently it has no spare wheel, vehicle tools and no place to store a tyre. The tyre repair kit can be used to temporarily seal punctures up to ¼ inch in the tread area of the tyre. It can also be used to inflate an underinflated tyre. If the tyre has been separated from the wheel, has damaged sidewalls or has a large puncture, the tyre is too severely damaged for the tyre repair kit to be effective.

⚠ Warning

Do not drive faster than 50 mph.
Do not use for a lengthy period.
Steering and handling may be affected.

The tyre repair kit includes:



- A = Selector switch (Sealant/Air or Air only)
- B = On/Off button
- C = Pressure gauge

- D = Pressure deflation button
- E = Tyre sealant canister
- F = Sealant/Air hose (clear)
- G = Air only hose (black)
- H = Power plug

If you have a flat tyre:
Move the shift lever to P.

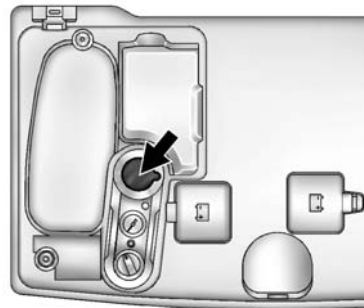

The tyre repair kit is under a cover in the load compartment.

Note

The driving characteristics of the repaired tyre is severely affected, therefore have this tyre replaced.

If unusual noise is heard or the compressor becomes hot, turn compressor off for at least 30 minutes.

The built-in safety valve opens at a pressure of 7 bar.

Note the expiry date of the kit. After this date its sealing capability is no longer guaranteed. Pay attention to storage information on sealant bottle.

Replace the used sealant bottle. Dispose of the bottle as prescribed by applicable laws.

The compressor and sealant can be used from approx. -30 °C.

Using the tyre repair kit to temporarily seal and inflate a punctured tyre

Follow the directions closely for correct usage.



When using the tyre repair kit during cold temperatures, warm the kit in a heated environment for five minutes. This will help to inflate the tyre faster.

If a tyre goes flat, avoid further tyre and wheel damage by driving slowly to a level place. Turn on the hazard warning flashers.

Hazard warning flashers ⇨ 91.

Do not remove any objects that have penetrated the tyre.

1. Take the tyre repair kit from the compartment.
2. Unwrap the sealant/air hose (F) and the power plug (H).
3. Place the kit on the ground.

Make sure the tyre valve stem is positioned close to the ground so the hose will reach it.

4. Remove the valve stem cap from the flat tyre by turning it counterclockwise.
5. Attach the sealant/air hose (F) onto the tyre valve stem. Turn it clockwise until it is tight.

6. Plug the power plug (H) into the accessory power outlet in the vehicle. Unplug all items from other accessory power outlets. Power outlets ⇨ 56.

Do not pinch the power plug cord in the door or window.

7. Start the vehicle. The vehicle must be running while using the air compressor.
8. Turn the selector switch (A) counterclockwise to the sealant + air position.
9. Press the On/Off button (B) to turn the tyre repair kit on. The compressor will inject sealant and air into the tyre. The pressure gauge (C) will initially show a high pressure while the compressor pushes the sealant into the tyre. Once the sealant is completely dispersed into the tyre, the pressure will quickly drop and start to rise again as the tyre inflates with air only.

10. Inflate the tyre to the recommended inflation pressure using the pressure gauge **(C)**.
Tyre and loading information label
↗ 156.

Tyre pressures ↗ 185.

The pressure gauge **(C)** may read higher than the actual tyre pressure while the compressor is on. Turn the compressor off to get an accurate pressure reading. The compressor may be turned on/off until the correct pressure is reached.

Note

If the recommended pressure cannot be reached after approximately 25 minutes, the vehicle should not be driven farther. The tyre is too severely damaged and the tyre repair kit cannot inflate the tyre. Remove the power plug from the accessory power outlet and unscrew the inflating hose from the tyre valve.

11. Press the on/off button **(B)** to turn the tyre repair kit off.

The tyre is not sealed and will continue to leak air until the vehicle is driven and the sealant is distributed in the tyre; therefore, steps 12 through 18 must be done immediately after step 11.

Be careful while handling the tyre repair kit as it could be warm after usage.

12. Unplug the power plug **(H)** from the accessory power outlet in the vehicle.
13. Turn the sealant/air hose **(F)** counterclockwise to remove it from the tyre valve stem.
14. Replace the tyre valve stem cap.
15. Replace the sealant/air hose **(F)**, and the power plug **(H)** back in their original location.

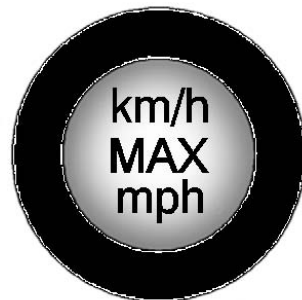

16. If the flat tyre was able to inflate to the recommended inflation pressure, remove the maximum speed label from the sealant canister **(E)** and place it in a highly visible location. Do not exceed the speed on this label until the damaged tyre is repaired or replaced.
17. Return the equipment to its original storage location in the vehicle.
18. Immediately drive the vehicle 8 km to distribute the sealant in the tyre.

19. Stop at a safe location and check the tyre pressure. Refer to steps 1 through 11 under using the tyre repair kit without sealant to inflate a tyre (Not Punctured).

If the tyre pressure has fallen more than 0.7 bar below the recommended inflation pressure, stop driving the vehicle. The tyre is too severely damaged and the tyre sealant cannot seal the tyre.

If the tyre pressure has not dropped more than 0.7 bar from the recommended inflation pressure, inflate the tyre to the recommended inflation pressure.

20. Wipe off any sealant from the wheel, tyre and vehicle.
21. Dispose of the used sealant canister (**E**) and sealant/air hose (**F**) assembly at a local dealer or in accordance with local laws and practices.
22. Replace it with a new canister available from a workshop.

23. After temporarily sealing a tyre using the tyre repair kit, take the vehicle to a workshop within a 100 miles of driving to have the tyre repaired or replaced.

Using the tyre repair kit without sealant to inflate a tyre (Not punctured)

To use the air compressor to inflate a tyre with air only and not sealant:



If a tyre goes flat, avoid further tyre and wheel damage by driving slowly to a level place. Turn on the hazard warning flashers.

Hazard warning flashers ⇨ 91.

1. Take the tyre repair kit from the compartment.
2. Unwrap the air only hose **(G)** and the power plug **(H)**.
3. Place the kit on the ground.
Make sure the tyre valve stem is positioned close to the ground so the hose will reach it.
4. Remove the tyre valve stem cap from the flat tyre by turning it counterclockwise.
5. Attach the air only hose **(G)** onto the tyre valve stem by turning it clockwise until it is tight.
6. Plug the power plug **(H)** into the accessory power outlet in the vehicle. Unplug all items from other accessory power outlets.
Power outlets ⇨ 56.
Do not pinch the power plug cord in the door or window.
7. Start the vehicle. The vehicle must be running while using the air compressor.

8. Turn the selector switch **(A)** clockwise to the air only position.
9. Press the on/off **(B)** button to turn the compressor on. The compressor will inflate the tyre with air only.
10. Inflate the tyre to the recommended inflation pressure using the pressure gauge **(C)**.
Tyre and loading information label ⇨ 156.
Tyre pressures ⇨ 185.
The pressure gauge **(C)** may read higher than the actual tyre pressure while the compressor is on. Turn the compressor off to get an accurate reading. The compressor may be turned on/off until the correct pressure is reached.
If you inflate the tyre higher than the recommended pressure you can adjust the excess pressure by pressing the pressure deflation button **(D)**, if equipped, until the proper pressure reading is reached. This option is only

functional when using the air only hose **(G)**.

11. Press the on/off button **(B)** to turn the tyre repair kit off.
Be careful while handling the tyre repair kit as it could be warm after usage.
12. Unplug the power plug **(H)** from the accessory power outlet in the vehicle.
13. Disconnect the air only hose **(G)** from the tyre valve stem by turning it counterclockwise, and replace the tyre valve stem cap.
14. Replace the air only hose **(G)** and the power plug **(H)** and cord back in their original locations.
15. Place the equipment in the original storage location in the vehicle.



The tyre repair kit has an accessory adapter located in a compartment on the bottom of its housing that may be used to inflate air mattresses, balls, etc.

Removal and installation of the sealant canister

To remove the sealant canister:

1. Unwrap the sealant hose.
2. Press the canister release button.
3. Pull up and remove the canister.

4. Replace with a new canister which is available from a workshop.
5. Push the new canister into place.

Jump starting

Jump starting is connecting jumper cables between the two vehicles to enable vehicle starting. If the vehicle or another vehicle has a run-down 12 volt battery, it can be jump started using good condition jumper cables. There are different procedures depending on if the vehicle has a run-down battery or another vehicle has a run-down battery. Read the appropriate procedures that follow.

⚠ Danger

The high voltage battery cannot be jump started either with another vehicle or battery charger. Personal injury, death, or damage to the vehicle could result.

⚠ Warning

Be extremely careful when starting with jump leads. Any deviation from the following instructions can lead to injuries or damage caused by battery explosion or damage to the electrical systems of both vehicles.

⚠ Warning

Avoid contact of the battery with eyes, skin, fabrics and painted surfaces. The fluid contains sulphuric acid which can cause injuries and damage in the event of direct contact.

⚠ Warning

Electric fans can start up even when the engine is not running and can cause injury. Keep hands, clothing and tools away from any underhood electric fans.

Jump starting the vehicle

If the vehicle won't start, the 12 volt battery may be run down. To jump start the vehicle use the underhood remote positive (+) and negative (-) terminals.

1. The other vehicle used to jump start your vehicle must have a 12 volt battery with a negative ground system.
2. Park both vehicles close enough so that the jumper cables can reach both vehicles' positive (+) and negative (-) terminals. The vehicles must not touch each other. It could cause an unwanted ground connection that could damage both vehicles' electrical systems.

Put both vehicles in **P** for an automatic transmission or electric drive unit. For a manual transmission, place the vehicle in neutral and apply the parking brake.

3. Switch off the ignition on the other vehicle. Turn off the radio, all lamps and accessories that are

not needed in both vehicles. Unplug accessories from the accessory power outlets. This avoids sparks and helps save both batteries and accessories.

4. Locate the positive (+) and negative (-) terminals on the other vehicle.

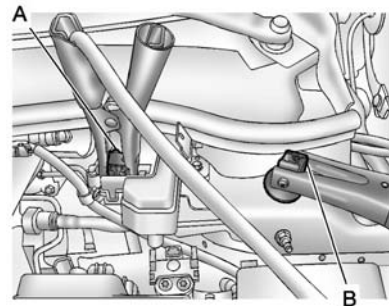

5. Open the bonnet to locate the positive (+) and negative (-) terminals on your vehicle. Open the access cover (**A**) for the remote positive (+) terminal. The remote negative terminal (**B**) for the vehicle is a stud marked GND (-) in the engine compartment.

6. Check that the jumper cables do not have loose or missing insulation or a shock could result and the vehicles could be damaged.

Before connecting the jumper cables, here are some basic things to know. Positive (+) jumper cable goes to positive (+) battery terminal or a remote positive (+) terminal if available. Negative (-) jumper cable goes to negative (-) battery terminal or a remote negative (-) terminal if available. Do not connect positive (+) to negative (-) or there will be a short that may damage the battery and other parts of the vehicle.

Connecting the jumper cables

1. Connect the red positive (+) jumper cable to the remote positive (+) terminal **(A)** of the vehicle. Do not let the other end of the cable touch metal.
2. Connect the other end of the red positive (+) jumper cable to the positive (+) terminal of the other vehicle.

3. Connect the black negative (-) jumper cable to the negative (-) battery terminal of the other vehicle battery. Do not let the other end touch anything until the next step.
4. Connect the other end of the black negative (-) jumper cable to the remote negative (-) terminal of the vehicle.
5. Push \odot button to start. This will wake up the electronics on the vehicle. After the instrument cluster initialises, the vehicle will use power from the high voltage battery to charge the 12 volt battery. The jumper cables can then be disconnected. If the vehicle does not start, seek the assistance of a workshop.

Disconnecting the jumper cables

1. Disconnect the black negative (-) jumper cable from the vehicle. Do not let the other end of the cable touch anything until after the next step.

2. Disconnect the black negative (-) jumper cable from the other vehicle with the good battery.
3. Disconnect the red positive (+) jumper cable from the other vehicle. Do not let the other end of the cable touch anything until after the next step.
4. Disconnect the red positive (+) jumper cable from the vehicle.
5. Return the positive (+) and negative (-) terminal covers to their original positions.

Jump starting another vehicle

When using the vehicle to jump start another vehicle with a rundown battery, jumper cables are connected directly to the positive (+) and negative (-) terminals on the 12 volt battery in the rear cargo area. Do not use the remote terminals under the bonnet. This could cause a fuse to overload in the vehicle.

1. Check the other vehicle. It must have a 12 volt battery with a negative ground system.

- Park both vehicles close enough so that the jumper cables can reach both vehicles' positive (+) and negative (-) terminals. The vehicles must not touch each other. It could cause an unwanted ground connection that could damage both vehicles' electrical systems.

Put both vehicles in **P** for an automatic transmission or electric drive unit. For a manual transmission, place the vehicle in neutral and apply the parking brake.

- Turn off both vehicles. Turn off the radio, all lamps, and accessories that are not needed in both vehicles. Unplug accessories from the accessory power outlets. This avoids sparks and helps save both batteries and accessories.
- Locate the positive (+) and negative (-) terminals on the vehicle with the run-down battery.

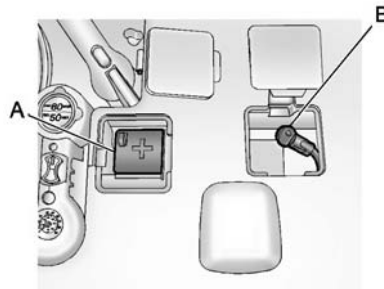

- Locate the positive (+) and negative (-) battery terminals on the vehicle. The access cover is under the load floor access cover in the rear cargo area. Open the access cover for the positive (+) terminal cover (**A**) and the negative (-) terminal cover (**B**).
- Check that the jumper cables do not have loose or missing insulation or a shock could result and the vehicles could be damaged.

Before connecting the jumper cables, here are some basic things to know. Positive (+)

jumper cable goes to positive (+) battery terminal or a remote positive (+) terminal if available. Negative (-) jumper cable goes to remote negative (-) terminal if available, or a heavy, unpainted metal engine part or a solid engine ground on the vehicle with the run-down battery.

Do not connect positive (+) to negative (-) or there will be a short that may damage the battery or other parts of the vehicle. Do not connect the negative (-) cable to the negative (-) terminal on the rundown battery because this can cause sparks.

Connecting the jumper cables

- Connect the red positive (+) jumper cable to the positive (+) terminal of the other vehicle with the run-down battery. Use a remote positive (+) terminal if available. Do not let the other end touch metal.

2. Connect the other end of the red positive (+) jumper cable to the positive (+) battery terminal of the vehicle.
3. Connect the black negative (-) jumper cable to the negative (-) battery terminal of the vehicle. Do not let the other end touch anything until the next step.
4. Make the final connection to a heavy, unpainted metal engine part or to the remote negative (-) terminal on the other vehicle with the run-down battery.
5. Press \odot to start the vehicle. This will wake up the electronics on the vehicle. The engine will only start if it is needed.
6. Try to start the other vehicle that had the run-down battery. If it will not start after a few tries, it probably needs service.

Disconnecting the jumper cables

1. Disconnect the black negative (-) jumper cable from the other vehicle that had the run-down

battery. Do not let the other end of the cable touch anything until after the next step.

2. Disconnect the black negative (-) jumper cable from the vehicle.
3. Disconnect the red positive (+) jumper cable from the vehicle. Do not let the other end of the cable touch anything until after the next step.
4. Disconnect the red positive (+) jumper cable from the other vehicle.
5. Return the positive (+) and negative (-) terminal covers to their original positions.

Towing

Towing the vehicle

Caution
<p>Incorrectly towing of a disabled vehicle may cause damage to the vehicle. The disabled vehicle should just be towed on a flatbed car carrier.</p> <p>Let the vehicle just be towed by well trained technicians.</p>

Towing another vehicle

The vehicle is neither designed nor intended to tow a trailer or another vehicle.

Appearance care

Exterior care

Locks

The locks are lubricated at the factory using a high quality lock cylinder grease. Use de-icing agent only when absolutely necessary, as this has a degreasing effect and impairs lock function. After using de-icing agent, have the locks regreased by a workshop.

Washing

The paintwork of your vehicle is exposed to environmental influences. Wash and wax your vehicle regularly. When using automatic vehicle washes, select a programme that includes waxing.

Bird droppings, dead insects, resin, pollen and the like should be cleaned off immediately, as they contain aggressive constituents which can cause paint damage.

If using a vehicle wash, comply with the vehicle wash manufacturer's instructions. The windscreen wiper and rear window wiper must be switched off. Remove antenna and external accessories such as roof racks etc.

If you wash your vehicle by hand, make sure that the insides of the wheel housings are also thoroughly rinsed out.

Clean edges and folds on opened doors and the bonnet as well as the areas they cover.

Have the door hinges of all doors greased by a workshop.

Do not clean the engine compartment with a steam-jet or high-pressure jet cleaner.

Thoroughly rinse and leather-off the vehicle. Rinse leather frequently. Use separate leathers for painted and glass surfaces: remnants of wax on the windows will impair vision.

Exterior lights

Headlight and other light covers are made of plastic. Do not use any abrasive or caustic agents, do not use an ice scraper, and do not clean them dry.

Polishing and waxing

Wax the vehicle regularly (at the latest when water no longer beads). Otherwise, the paintwork will dry out.

Polishing is necessary only if the paint has become dull or if solid deposits have become attached to it.

Paintwork polish with silicone forms a protective film, making waxing unnecessary.

Plastic body parts must not be treated with wax or polishing agents.

Windows and windscreen wiper blades

Use a soft lint-free cloth or chamois leather together with window cleaner and insect remover.

When cleaning the rear window, make sure the heating element inside is not damaged.

For mechanical removal of ice, use a sharp-edged ice scraper. Press the scraper firmly against the glass so that no dirt can get under it and scratch the glass.

Clean smearing wiper blades with a soft cloth and window cleaner.

Wheels and tyres

Do not use high-pressure jet cleaners.

Clean rims with a pH-neutral wheel cleaner.

Rims are painted and can be treated with the same agents as the body.

Paintwork damage

Rectify minor paintwork damage with a touch-up pen before rust forms. Have more extensive damage or rust areas repaired by a workshop.

Underbody

Some areas of the vehicle underbody have a PVC undercoating while other critical areas have a durable protective wax coating.

After the underbody is washed, check the underbody and have it waxed if necessary.

Bitumen/rubber materials could damage the PVC coating. Have underbody work carried out by a workshop.

Before and after winter, wash the underbody and have the protective wax coating checked.

Front air deflector

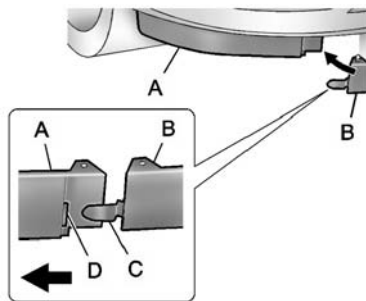

A = Outer air deflector
B = Inner air deflector

C = Tab

D = Slot

The front air deflector allows air to flow cleaner under the vehicle. Should the front air deflector become detached, insert tab (**C**) into slot (**D**). Repeat for the other side.

Interior care

Interior and upholstery

Only clean the vehicle interior, including the instrument panel fascia and panelling, with a dry cloth or interior cleaner.

Clean the leather upholstery with clear water and a soft cloth. In case of heavy soiling, use leather care.

The instrument panel should only be cleaned using a soft damp cloth.

Clean fabric upholstery with a vacuum cleaner and brush. Remove stains with an upholstery cleaner.

Clean seat belts with lukewarm water or interior cleaner.

Caution

Close Velcro fasteners as open Velcro fasteners on clothing could damage seat upholstery.

The same applies to clothing with sharp-edged objects, like zips or belts or studded jeans.

Plastic and rubber parts

Plastic and rubber parts can be cleaned with the same cleaner as used to clean the body. Use interior cleaner if necessary. Do not use any other agent. Avoid solvents and petrol in particular. Do not use high-pressure jet cleaners.

Service and maintenance

General information	176
Recommended fluids, lubricants and parts	177

General information

Service information

In order to ensure economical and safe vehicle operation and to maintain the value of your vehicle, it is of vital importance that all maintenance work is carried out at the proper intervals as specified.

The detailed, up-to-date service schedule for your vehicle is available at the workshop.

Service intervals

Maintenance of your vehicle is required every 20,000 miles or after 1 year, whichever occurs first, unless otherwise indicated in the service display.

Confirmations

Confirmation of service is recorded in the Service and Warranty Booklet. The date and mileage is completed with the stamp and signature of the servicing workshop.

Make sure that the Service and Warranty Booklet is completed correctly as continuous proof of service is essential if any warranty or goodwill claims are to be met, and is also a benefit when selling the vehicle.

Service interval with remaining engine oil life duration

The service interval is based on several parameters depending on usage.

A message in the Driver Information Centre (DIC) lets you know when to change the engine oil.

Driver Information Centre (DIC) ↪ 67.
Vehicle messages ↪ 81.

Recommended fluids, lubricants and parts

Recommended fluids and lubricants

Only use products that have been tested and approved. Damage resulting from the use of non-approved materials will not be covered by the warranty.

Warning

Operating materials are hazardous and could be poisonous. Handle with care. Pay attention to information given on the containers.

Engine oil

Engine oil is identified by its quality and its viscosity. Quality is more important than viscosity when selecting which engine oil to use. The oil quality ensures e.g. engine cleanliness, wear protection and oil

aging control, whereas viscosity grade gives information on the oil's thickness over a temperature range.

Dexos is the newest engine oil quality that provides optimum protection for gasoline and diesel engines. If it is unavailable, engine oils of other listed qualities have to be used.

Recommendations for gasoline engines are also valid for Compressed Natural Gas (CNG), Liquefied Petroleum Gas (LPG) and Ethanol (E85) fuelled engines.

Select the appropriate engine oil based on its quality and on the minimum ambient temperature ⇨ 179.

Topping up engine oil

Engine oils of different manufacturers and brands can be mixed as long as they comply with the required engine oil quality and viscosity.

Use of engine oil with only ACEA A1 or only A5 quality is prohibited, since it can cause long-term engine damage under certain operating conditions.

Select the appropriate engine oil based on its quality and on the minimum ambient temperature ⇨ 179.

Additional engine oil additives

The use of additional engine oil additives could cause damage and invalidate the warranty.

Engine oil viscosity grades

The SAE viscosity grade gives information of the thickness of the oil.

Multigrade oil is indicated by two figures, e.g. SAE 5W-30. The first figure, followed by a W, indicates the low temperature viscosity and the second figure the high temperature viscosity.

Select the appropriate viscosity grade depending on the minimum ambient temperature ⇨ 179.

All of the recommended viscosity grades are suitable for high ambient temperatures.

Coolant and antifreeze

Use only silicate-free long life coolant (LLC) antifreeze approved for the vehicle, consult a workshop.

The system is factory filled with coolant designed for excellent corrosion protection and frost protection down to approx. -28 °C. This concentration should be maintained all year round. The use of additional coolant additives that intend to give additional corrosion protection or seal against minor leaks can cause function problems. Liability for consequences resulting from the use of additional coolant additives will be rejected.

Brake fluid

Only use high-performance brake fluid approved for the vehicle, consult a workshop.

Over time, brake fluid absorbs moisture which will reduce braking effectiveness. The brake fluid should therefore be replaced at the specified interval.

Brake fluid should be stored in a sealed container to avoid water absorption.

Ensure brake fluid does not become contaminated.

Technical data

Vehicle identification 179
 Vehicle data 180

Vehicle identification

Vehicle Identification Number



The Vehicle Identification Number (VIN) is located in the left front corner of the instrument panel. It is visible through the windscreen.



The VIN also appears on the vehicle certification and service parts labels and certificates of title and registration.

Engine identification

The eighth character in the VIN is the engine code. This code identifies the vehicle's engine, specifications, and replacement parts.

Service Parts identification label

The label is inside the right rear cargo storage door and has the following information:

- Vehicle Identification Number (VIN)
- Model designation
- Paint information
- Production options and special equipment

Do not remove this label from the vehicle.

Vehicle data

Recommended fluids and lubricants

European service schedule

Required engine oil quality

Engine oil quality	All European countries (except Belarus, Moldova, Russia, Serbia, Turkey)		Only Israel	
	Petrol engines (including CNG, LPG, E85)	Diesel engines	Petrol engines (including CNG, LPG, E85)	Diesel engines
dexos 1	–	–	✓	–
dexos 2	✓	✓	–	✓

In case dexos quality is unavailable you may use max. 1 litre engine oil quality ACEA C3 once between each oil change.

Engine oil viscosity grades

All European countries and Israel (except Belarus, Moldova, Russia, Serbia, Turkey)	
Ambient temperature	Petrol and diesel engines
down to -25 °C	SAE 5W-30 or SAE 5W-40
below -25 °C	SAE 0W-30 or SAE 0W-40

International service schedule

Required engine oil quality

Engine oil quality	All countries outside Europe except Israel		Only Belarus, Moldova, Russia, Serbia, Turkey	
	Petrol engines (including CNG, LPG, E85)	Diesel engines	Petrol engines (including CNG, LPG, E85)	Diesel engines
dexos 1	✓	–	–	–
dexos 2	–	✓	✓	✓

In case dexos quality is unavailable you may use the oil qualities listed below:

Engine oil quality	All countries outside Europe except Israel		Only Belarus, Moldova, Russia, Serbia, Turkey	
	Petrol engines (including CNG, LPG, E85)	Diesel engines	Petrol engines (including CNG, LPG, E85)	Diesel engines
GM-LL-A-025	✓	–	✓	–
GM-LL-B-025	–	✓	–	✓

Engine oil quality	All countries outside Europe except Israel		Only Belarus, Moldova, Russia, Serbia, Turkey	
	Petrol engines (including CNG, LPG, E85)	Diesel engines	Petrol engines (including CNG, LPG, E85)	Diesel engines
ACEA A3/B3	✓	–	✓	–
ACEA A3/B4	✓	✓	✓	✓
ACEA C3	✓	✓	✓	✓
API SM	✓	–	✓	–
API SN	✓	–	✓	–

Engine oil viscosity grades

All countries outside Europe (except Israel), including Belarus, Moldova, Russia, Serbia, Turkey	
Ambient temperature	Petrol and diesel engines
down to -25 °C	SAE 5W-30 or SAE 5W-40
below -25 °C	SAE 0W-30 or SAE 0W-40

Engine data

Engine	A14XFL Petrol	Electric motor
Number of cylinders	4	-
Piston displacement [cm ³]	1398	-
Power (Engine/Electric motor) [kW]	63	111
at rpm	4800	5000
Torque [Nm]	126	370
at rpm	4250	250-2800
Fuel type	Petrol	-
Octane rating RON		
recommended	95	-
possible	98	-

Performance

A14XFL Petrol

Electric motor

Maximum speed ¹⁾ [mph]	100 mph
-----------------------------------	---------

Vehicle weight

Kerb weight [kg]	1735
------------------	------

Vehicle dimensions

Length [mm]	4498
-------------	------

Width [mm]	1787
------------	------

Height (unladen) [mm]	1439
-----------------------	------

Wheelbase [mm]	2685
----------------	------

¹⁾ The maximum speed indicated is achievable at kerb weight (without driver) plus 200 kg payload. Optional equipment could reduce the specified maximum speed of the vehicle.

Capacities

Engine oil

Engine	A14XFL
including Filter [l]	3,5
between MIN and MAX [l]	1

Fuel tank

Petrol, nominal capacity [l]	35,2
------------------------------	------

Tyre pressures

Tyres	Comfort with up to 3 people		ECO with up to 3 people		With full load	
	front	rear	front	rear	front	rear
	[kPa/bar] ([psi])	[kPa/bar] ([psi])	[kPa/bar] ([psi])	[kPa/bar] ([psi])	[kPa/bar] ([psi])	[kPa/bar] ([psi])
215/55 R17,	240/2.4 (35)	240/2.4 (35)	270/2.7 (39)	270/2.7 (39)	250/2.5 (36)	290/2.9 (42)
225/45 R18 ²⁾	260/2.6 (38)	260/2.6 (38)	280/2.8 (41)	280/2.8 (41)	270/2.7 (39)	310/2.4 (45)
205/60 R16 ³⁾	260/2.6 (38)	260/2.6 (38)	280/2.8 (41)	280/2.8 (41)	270/2.7 (39)	310/2.4 (45)

²⁾ Reinforced variant (XL).

³⁾ Only permitted as winter tyres.

Customer information

Customer information	186
Vehicle data recording and privacy	187

Customer information

Service network

Open source information

This vehicle contains open source software, including without limitation, software distributed and/ or modified under the GNU General Public License, Version 2, June 1991 and the GNU Lesser General Public License, Version 2.1, February 1999.

See www.oss.gm.com for additional information and to download related materials, including without limitation, the previous referred to licenses and software.

Customer assistance offices

My Ampera service - contact telephone numbers for the owner's manual

We aim to provide you with an excellent customer experience.

In the unlikely event that you have a problem, your authorised dealership will be more than happy to assist you.

Alternatively our **My Ampera** helpline can provide additional support in coordinating roadside assistance or responding to any enquiry or question relating to your vehicle:

- **Austria:**
0800 301024
- **Belgium:**
0800 58115
- **Czech Republic:**
800 701018
- **Denmark:**
804 04 933
- **Finland:**
0800 523 109
- **France:**
0805 980004
- **Germany:**
0800 2022011

- **Greece:**
00800 331 52 963
 - **Hungary:**
0680204997
 - **Ireland:**
1800 812 450
 - **Italy:**
800089741
 - **Luxembourg:**
800 40004
 - **Netherlands:**
0800 020 5915
 - **Norway:**
800 62072
 - **Poland:**
00800 331 1407
 - **Romania:**
0800 801020
 - **Slovakia:**
800 116 981
 - **Spain:**
900 900 428
- **Sweden:**
020 120 3022
 - **Switzerland:**
0800 455565
 - **United Kingdom:**
0800 0260275

Vehicle data recording and privacy

Event data recorders

The vehicle has a number of sophisticated systems that monitor and control several vehicle data. Some data may be stored during regular operation to facilitate repair of detected malfunctions, other data is stored only in a crash or near crash event by modules in your vehicle systems that have an event data recording function such as the airbag control module.

The systems may record diagnostic data about the condition of the vehicle (e.g. oil level or vehicle mileage) and information how it was operated (e.g. engine speed, brake application and seat belt usage).

To read this data, special equipment and access to the vehicle is required. Some diagnostic data is electronically fed into Vauxhall global systems when the vehicle is serviced in a workshop, in order to document the

service history of the vehicle. This enables the workshop to offer you efficient maintenance and repair, tailored to your individual vehicle, each time you bring it back to the workshop.

The manufacturer will not access driver's behaviour related information about a crash event or share it with others except:

- with the consent of the vehicle owner or, if the vehicle is leased, of the lessee
- in response to an official request of police or similar government office
- as part of the manufacturer's defence in case of legal proceedings
- as required by law

In addition, the manufacturer may use the collected or received diagnostic data:

- for the manufacturer's research needs
- to make it available for research needs where appropriate confidentiality is maintained and need is shown
- to share summary data which is not tied to a specific vehicle with other organisations for research purposes

Radio Frequency Identification (RFID)

RFID technology is used in some vehicles for functions such as tyre pressure monitoring and ignition system security. It is also used in connection with conveniences such as radio remote controls for door locking/unlocking and starting, and in-vehicle transmitters for garage door openers. RFID technology in Vauxhall vehicles does not use or record personal information or link with any other Vauxhall system containing personal information.

Index

- A**
- Accessories and vehicle modifications 135
 - Airbag and belt tensioners 61
 - Airbag deactivation 42, 62
 - Airbag system 40
 - Air intake 100
 - Air vents 100
 - Antilock brake system 113
 - Antilock brake system (ABS) 63
 - Anti-theft alarm system 27
 - Anti-theft locking system 26
 - Automatic anti-dazzle 29
 - Automatic climate control system 95
 - Automatic light control 90
- B**
- Battery 141
 - Battery discharge protection 94
 - Battery gauge 58
 - Battery replacement 20
 - Bonnet 137
 - Brake fluid 140, 177
 - Brakes 140
 - Brake system 63
 - Bulb replacement 143
- C**
- Capacities 185
 - Car Pass 19
 - Central locking system 23
 - Changing tyre and wheel size ... 161
 - Charge cord 128
 - Charging 125
 - Charging status 127
 - Charging system 62
 - Child locks 24
 - Child restraint installation locations 45
 - Child restraint systems 43
 - Climate control 14
 - Clock 56
 - Colour-Info-Display 69
 - Control indicators 59
 - Control of the vehicle 102
 - Convex shape 28
 - Coolant 138
 - Coolant and antifreeze 177
 - Cooling system 138
 - Cruise control 66, 118
 - Curtain airbag system 41
 - Customer assistance offices 186
- D**
- Danger, Warnings and Cautions ... 4
 - Dome lights 93
 - Door open 66
 - Door panel storage 49
 - Drive modes 107
 - Driver Information Centre 67

Driving economically.....	101
Driving efficiency gauge.....	58

E

Electric adjustment	28
Electrical parking brake.....	63
Electrical parking brake fault.....	63
Electrical requirements.....	131
Electrical system overload	146
Electric drive unit.....	15
Electric mode.....	106
Electric vehicle operation modes..	16
Electronic Stability Control.....	117
Electronic Stability Control and Traction Control system.....	64
Electronic Stability Control off.....	64
Engine compartment fuse box ...	148
Engine coolant temperature	64
Engine data	183
Engine exhaust	111
Engine oil	138, 177, 180
Engine oil pressure	65
Engine overheating.....	140
Entry lighting	94
Event data recorders.....	187
Exit lighting	94
Extended range mode.....	106
Exterior care	173
Exterior light	65
Exterior lighting	12

F

First aid kit	52
Floor console storage.....	50
Folding	29
Front airbag system	40
Fuel consumption - CO ₂ - Emissions	133
Fuel for petrol engines	132
Fuel gauge	57
Fuses	147

G

General information	134
Glovebox	49

H

Halogen bulbs.....	143
Halogen headlights	143
Hand brake.....	114
Hazard warning flashers	91
Headlight aiming.....	143
Headlight flash	91
Headlight range adjustment	91
Head restraint adjustment	8
Head restraints	32
Heated	29
Heated rear window	31
Heating	35
High beam	65, 91
High voltage devices and wiring	146

Hold mode.....	64
Horn	13, 55

I

Immobiliser	28, 65
Instrument cluster display.....	68
Instrument panel fuse box	151
Instrument panel illumination control	93
Instrument panel overview	10
Instrument panel storage.....	49
Interior care	174
Introduction	3
ISOFIX child restraint systems ...	48

J

Jump starting	168
---------------------	-----

K

Keys	19
Knee airbag system.....	42

L

Lifting the vehicle.....	135
Light switch	90
Load compartment	25, 50
Load compartment cover	51
Load compartment fuse box	154
Loading information	52
Low fuel	65

M

Maintenance modes.....	109
Malfunction indicator light	62
Mirror adjustment	9
Misted light covers	92
Mountain mode.....	64

N

New vehicle running-in	102
Number plate light	145

O

Odometer	57
Oil, engine.....	177, 180
Open&Start system	22
Operation.....	106, 111

P

Parking	18, 106
Parking brake	114
Parking lights	92
Pedestrian safety alert.....	13, 55
Performance	184
Performing work	137
Pollen filter	100
Power button.....	102
Power outlets	56
Power windows	29
Programmed charging override..	127

R

Radio Frequency Identification (RFID).....	188
Radio remote control	20
Reading lights	93
Rear fog light	65, 145
Rear fog lights	92
Rear view camera	123
Recommended fluids and lubricants	177, 180
Refuelling	132
Regenerative braking.....	115
Remote start.....	20
Retained power off.....	104
Reversing light	144
Reversing lights	92

S

Seat adjustment	7, 34
Seat belt	8
Seat belt reminder	61
Seat belts	36
Seat position	33
Service	100, 176
Service display	58
Service information	176
Service network.....	186
Service Parts identification label	179
Side airbag system	41

Side turn signal lights	144
Speedometer	57
Sport mode	64
Starting and stopping the vehicle.....	104
Starting off	16
Steering wheel adjustment	9, 54
Steering wheel controls	54
Sun visors	31
Symbols	4

T

Tail lights	144
Three-point seat belt	37
Top-tether fastening eyes	48
Total vehicle range.....	58
Towing.....	134
Towing another vehicle	172
Towing the vehicle	172
Traction Control system	116
Traction Control system off.....	64
Tread depth	161
Trip odometer	57
Turn and lane-change signals	92
Turn signal	61
Tyre and loading information label.....	156
Tyre chains	162
Tyre designations	156
Tyre pressure	156

Tyre pressure monitoring system.....	65, 157
Tyre pressures	185
Tyre repair kit	162
Tyres	156

U

Ultrasonic parking assist.....	120
Using this manual	3

V

Vehicle dimensions	184
Vehicle Identification Number	179
Vehicle messages	81
Vehicle personalisation	82
Vehicle ready.....	65
Vehicle specific data	3
Vehicle unlocking	6
Vehicle weight	184

W

Warning triangle	52
Washer and wiper systems	14
Washer fluid	140
Wheel covers	162
Wheels and tyres	156
Windscreen wiper/washer	55
Winter tyres	156
Wiper blade replacement	142

