

Zafira

2010 Models Edition 2







make the world adjust to you

Zafira shows what can be achieved with clever thinking. All that dynamic driving experience, interior comfort and built-in seven-seater flexibility – but with sharp styling, cool interior finishes and impressive safety features.

This brochure covers Expression, Life, Exclusiv, Design, Elite, SRi and SRi with Exterior Pack models only. Some of the vehicles shown in this brochure include options and accessories available at extra cost. And not all of the features described are available on every model. So please check the Equipment section for further details. From time to time, we also offer alternative Zafira models such as Special Editions, featured in their own separate literature or found on the Vauxhall website www.vauxhall.co.uk

Exterior styling	4
Driveability	6
Interior comfort	8
Flex7® seating	10
Panoramic roof	12
Environmental issues	14
Driving dynamics	16
Safety and security	18
Interior features	20
Model line-up	22
Options and accessories	28
Zafira VXR	32
Colours and trims	36
Equipment	38
Technical data	46

always cruise in style

Fed up with boxy looking MPVs? Here's a welcome change. A seven-seater compact people carrier that's definitely got the X-factor. With its radical, tapered roofline, dynamic front grille and bumper shapes, chrome headlight surrounds and great alloy wheel designs too, family travel has never been so attractive.









something for everyone

Yet another dilemma solved. Brilliant family transport and great to drive too – whether you're just one or seven-up. The dynamic Zafira chassis combines precise, secure roadholding with built-in technological innovation. And Vauxhall's advanced engine technology means efficient, multi-valve engines – as flexible and responsive as they are economical and environmentally aware.



real comfort wherever you sit

Zafira's design themes move effortlessly from outside to inside with a driver-friendly fascia and high quality interior finishes throughout. And while it's easy for the driver to get comfortable, this is a car designed to make travel easy for the whole family. So it's light and spacious, comfortable and clever – wherever you're sitting.





space for a quality lifestyle

This is what versatility looks like. And it's all down to clever design – Flex7® seating, adaptable luggage space and plenty of smart storage ideas for all your essential travelling kit.







a different look at life

Talk about personalised travel arrangements! The optional Zafira panoramic roof gives you four tinted glass roof panels – with separate, electrically-operated sunblinds – and a five-compartment, central overhead console. So there's always somewhere to put your mobile phone, personal music player, sunglasses or hand held games console.





Zafira Exclusiv



respect your world.

We all share a responsibility to look after our world. That's why Vauxhall has been at the forefront of green automotive initiatives for many years. We are always looking to reduce the impact of our vehicles on the environment, of course, and the Zafira 1.7CDTi 16v ecoFLEX models have among the lowest CO₂ emissions of any seven-seat MPV.

But our commitment to preserving the environment goes even further. We are working on even cleaner, alternative power sources, including zero-emission fuel cell technology for example. We have dramatically reduced manufacturing emissions, and our new models use more recycled materials and more recyclable parts than ever before.

We also offer free and easily accessible, environmentally friendly, end-of-life vehicle disposal through our partners Autogreen Ltd.

That way, we reduce our environmental impact in every phase of every vehicle's life cycle. Because your world is our world, too.



Life is better on the move

Think Zafira. Think advanced engine and chassis technology. Three petrol engines and three common rail turbo diesels – all brilliantly efficient with an impressive spread of power. And out on the road, a reassuring sense of control, helping you feel relaxed and secure under any conditions.



Petrol engines. Zafira's twin-cam 1.6i 16v VVT and 140PS 1.8i 16v VVT engines feature multi-point sequential fuel injection and utilise Double Continuous Variable Cam Phasing (DCVCP), which provides most of the available torque across a wide rev band. The result? More power and lower fuel consumption. And the all-aluminium, 150PS 2.2i 16v Direct uses direct petrol injection for outstanding fuel economy, flexibility and refinement.

CDTi diesels. That's 'CD' for common rail diesel technology, 'T' for turbocharged and 'i' for fuel injected. Put them all together and you've got the most up-to-date diesel technology around. All three Zafira engines are CDTi, providing serious diesel performance and economy, tough emissions control and low benefit in kind company car tax. Choose from two 1.9CDTi diesels – one rated at 120PS, the other at 150PS or the 1.7CDTi 16v (110PS) ecoFLEX.

ecoFLEX engine. Zafira ecoFLEX models feature a 1.7CDTi 16v (110PS) turbo diesel engine and have a CO₂ emissions figure of only 139g/km ensuring eligibility for the lower band E Vehicle Excise Duty charges.

▶ **Interactive Driving System-plus (IDS-plus).** This optional system senses changes in the vehicle dynamics and automatically adjusts the damper rates – in real time. The result is confident cornering and sharper handling with reduced body roll. Pretty smart for a seven-seater compact MPV. For further information please see page 51.

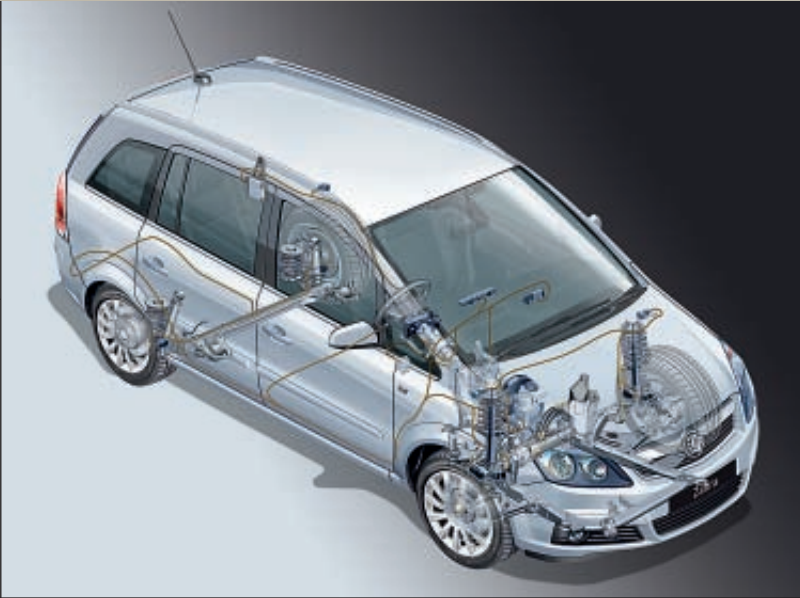

▶ **Sport switch.** Sports performance to suit your mood. Hit the Sport switch and you get a sharper throttle and more responsive steering. With optional IDS-plus you also get sportier chassis dynamics with more body control. It also controls the automatic transmission's Sport mode.

ESP-plus. Especially useful on wet roundabouts and greasy roads or whenever a slippery surface catches you out, Electronic Stability Programme-plus (ESP-plus), senses if the car starts to slide on a bend and applies corrective braking to the appropriate wheels to help you regain control. For further information please see page 51.



▶ **Automatic transmission.** The electronically-controlled, six-speed automatic has an adaptive driving function and a Winter mode, which selects third gear for standing starts in slippery conditions. It's available on both 1.9CDTi diesels. A four-speed automatic is available on 2.2i 16v Direct models.

Easytronic transmission. Choose the optional Easytronic transmission and you'll get a five-speed manual gearbox with a fully automatic mode. In manual mode, you simply push the lever forward or back to shift gears up or down. The facia display tells you what gear you're in – 1 to 5, N for Neutral or A for Auto. Switch to fully automatic mode and it has many of the features of a regular automatic including a kickdown function. There's no clutch pedal so you can drive it on an automatic-only driving licence.



▶ **Six-speed.** Zafira comes with a six-speed manual gearbox as standard on all 2.2i 16v, 1.7CDTi 16v and 1.9CDTi (120PS and 150PS) engines. Others come with a five-speed manual as standard, with four- and six-speed automatic and five-speed Easytronic transmission options also available at extra cost.

Intelligent, reassuring safety and security

Zafira has a strong reputation for safety and security, and with good reason. Every model has a five star EuroNCAP adult occupant safety rating, with six full-size airbags and a chassis that is packed with active safety innovations that help you avoid accidents before they happen. Security features include remote control central deadlocking.



Adaptive Forward Lighting (AFL).

The optional lighting system swivels the headlight beams up to 15 degrees for improved vision as you turn a corner. Above 65mph, it raises the dipped headlight beam slightly, also to increase safety – returning to normal beam automatically as speed is reduced. Turn to page 51 for more detailed information.

ISOFIX Child seat restraint system.

The rigid ISOFIX anchoring mechanism virtually eliminates the dangers of incorrect child seat installation. You simply click the optional accessory Vauxhall ISOFIX child seat into the mounting points engineered into the Zafira outer rear second-row seats.



www.euroncap.com



Anti-lock Braking System (ABS).

On its own, ABS is a huge benefit in emergency braking, but Zafira goes even further. Emergency Brake Assist (EBA), Electronic Brakeforce Distribution (EBD) and Cornering Brake Control (CBC) all make the car easier to control and stop under extreme cornering and braking.

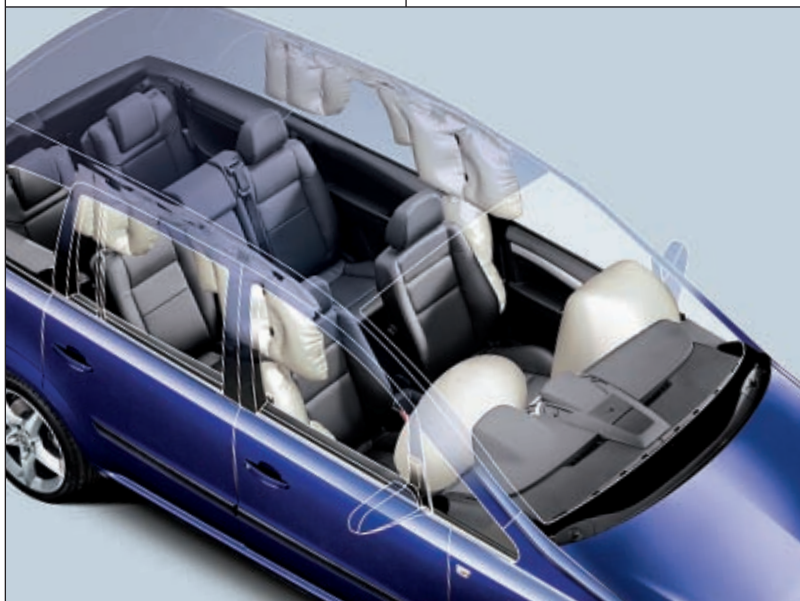

Remote control alarm system.

Standard on SRi, the ultrasonic security alarm system features forced entry detection, along with tilt, movement and rear glass breakage sensors, plus a power siren complete with its own power supply.

Six airbags. Zafira now protects you and your family with six full-size airbags as standard on every model. Specially developed to provide maximum protection, every model has twin front airbags, enlarged 'thorax-pelvis' front seat side-impact airbags and full-size curtain airbags too.



Keeping everybody happy

Zafira's Flex7® seating. It's not just about quantity. It's about quality too, making everyone feel comfortable – front and rear. Wherever you're sitting, you'll be amazed at what Zafira has to offer, whether it's features like air conditioning and rear seat audio or clever storage space for all your bits and bobs.



◀ ▶ ▾ Versatile load space.

When you're not using Zafira's third row seats, there's no need to remove them completely. Each one folds down separately, flush with the load floor. Add the optional FlexOrganiser® pack, and you've got the smartest, most versatile way to manage your load area ever!



▼ **Quality sounds.** Every Zafira features a quality CD player/stereo radio, with steering wheel mounted audio controls on many models. Optional systems add CD/MP3 format, user-friendly satellite navigation with colour display, and our independent rear seat Twin Audio® system*, (shown below) where the front and two second-row rear passengers can listen to the radio or a CD independently and at the same time. It comes with separate second-row rear seat audio controls – an on/off switch, independent volume controls for each headset (available as an accessory), switching between CD and radio tuner and a scan function. And it even mutes the rear speakers when the headphones are in use.



▼ **Air conditioning.** It makes for a fresher interior atmosphere all year round, with chilled air on hot days and faster demisting when it's damp. Move up to Electronic Climate Control (ECC), standard on Elite and optional on most other models and you can maintain the interior temperature to within a single degree.

▼ **Cruise control.** The easy-to-use, tap-up/tap-down cruise control is standard on Elite and optional on most other models. It allows you to maintain a steady speed without keeping your foot on the throttle. So it's more comfortable on long journeys and easier to keep to speed limits too.



▲ **Satellite navigation.** You'll never get lost with optional satellite navigation. It can determine your precise location and guide you to your destination by the best and fastest route. Turn to page 45 for more detailed information.



▲ **Mobile phone system with Bluetooth®**.** With the optional mobile phone system, your phone interfaces with the audio unit, for operation via the steering wheel controls and facia display. Bluetooth® wireless technology with voice activation is included. See page 45 for more detailed information.

▲ **Multi-function trip computer.** Standard on Zafira Design, Elite and SRI this invaluable driver information system provides instantaneous and average fuel consumption, fuel consumed, average speed, distance travelled and range based on fuel remaining.

*Does not include headsets. Fitted with industry standard 3.5mm audio sockets.



**Please refer to the online Vauxhall Car and Accessory Price Guide for a list of phone-specific cradles.

EXPRESSION AND LIFE

Standard features include:

- Anti-lock braking system
- Power-assisted steering
- Twin front airbags
- Front seat side-impact airbags
- Full-size curtain airbags
- Driver's seat height adjuster
- Electric door mirrors
- Electric front windows
- Remote control central deadlocking
- Steering wheel adjustable for reach and rake
- Air conditioning (Life models only*)
- CD player/stereo radio (CD 30)
- 12-volt auxiliary power socket located in luggage compartment
- Black roof rails (Life models only)



Engine availability	Insurance groups (ABI)
Expression	
1.6i 16v VVT	12E
Life	
1.6i 16v VVT	13E
1.8i 16v VVT	15E
1.8i 16v VVT Easytronic	15E
2.2i 16v Direct Automatic	17E
1.7CDTi 16v ecoFLEX	14E
1.9CDTi (120PS)	15E
1.9CDTi (120PS) Automatic	15E

*Non-air conditioned 1.6i 16v model also available

Life model interior illustrated.

Please note: Insurance groups relate to the 50 group rating.



EXCLUSIV

Standard features include:

- Anti-lock braking system
- Twin front airbags
- Front seat side-impact airbags
- Full-size curtain airbags
- Driver's seat height adjuster
- Electric front windows
- Remote control central deadlocking
- Steering wheel adjustable for reach and rake
- Air conditioning
- CD player/stereo radio (CD 30)

Additional features over and above Life model include:

- 16-inch Structure wheels
- Steering wheel mounted audio controls
- Electrically adjustable/heated door mirrors
- Body-colour door handles and side-protection mouldings

Engine availability	Insurance groups (ABI)
1.6i 16v VVT	12E
1.8i 16v VVT	15E
1.8i 16v VVT Easytronic	15E
2.2i 16v Direct Automatic	17E
1.7CDTi 16v ecoFLEX	14E
1.9CDTi (120PS)	15E
1.9CDTi (120PS) Automatic	15E



Please note: Insurance groups relate to the 50 group rating.

Model illustrated features two-coat metallic paint, optional at extra cost.

DESIGN

Standard features include:

- Anti-lock braking system
- Twin front airbags
- Front seat side-impact airbags
- Full-size curtain airbags
- Electric front windows
- Remote control central deadlocking
- Steering wheel adjustable for reach and rake
- Air conditioning
- CD player/stereo radio (CD 30)

Additional features over and above Exclusiv model include:

- 16-inch seven twin-spoke alloy wheels
- Dark-tinted rear glass
- Front fog lights
- Multi-function trip computer
- Electric rear windows
- Driver's armrest
- Driver's seat with tilt and lumbar adjustment
- Rain-sensitive windscreen wipers
- Leather-covered three-spoke steering wheel
- Alloy-effect roof rails

Additional features on 2.2i 16v Direct Automatic and 1.9CDTi 16v (150PS) models:

- 17-inch 10-spoke alloy wheels with 225/45 R 17 ultra-low profile tyres
- Electronic Stability Programme-plus (ESP-plus) with traction control
- Sports suspension
- Sport switch

Model illustrated features Panoramic Roof Pack, automatic transmission and two-coat metallic paint, optional at extra cost.



Engine availability	Insurance groups (ABI)
1.6i 16v VVT	15E
1.8i 16v VVT	15E
1.8i 16v VVT Easytronic	15E
2.2i 16v Direct Automatic	17E
1.7CDTi 16v ecoFLEX	14E
1.9CDTi (120PS)	18E
1.9CDTi (120PS) Automatic	18E
1.9CDTi 16v (150PS)	18E
1.9CDTi 16v (150PS) Automatic	18E

Please note: Insurance groups relate to the 50 group rating.



ELITE

Standard features include:

- Anti-lock braking system
- Six airbags
- Electric front and rear windows
- Dark-tinted rear glass
- Multi-function trip computer
- Driver's armrest
- Leather-covered three-spoke steering wheel
- Rain-sensitive windscreen wipers
- Alloy-effect roof rails

Additional features over and above Design model include:

- Leather seat facings on front and second row seats (third row seats trimmed in Morrocana)
- Electrically heated sports front seats with tilt and lumbar adjustment
- Electronic climate control
- Cruise control
- CD player with MP3 format/auxiliary-in socket/stereo radio (CD 30 MP3)

Additional features on 2.2i 16v Direct and 1.9CDTi 16v (150PS) models:

- 17-inch 10-spoke alloy wheels with 225/45 R 17 ultra-low profile tyres
- Electronic Stability Programme-plus (ESP-plus) with traction control
- Sports suspension
- Sport switch

Engine availability	Insurance groups (ABI)
1.8i 16v VVT	16E
2.2i 16v Direct	18E
2.2i 16v Direct Automatic	18E
1.7CDTi 16v ecoFLEX	15E
1.9CDTi (120PS)	19E
1.9CDTi (120PS) Automatic	19E
1.9CDTi 16v (150PS)	19E
1.9CDTi 16v (150PS) Automatic	19E

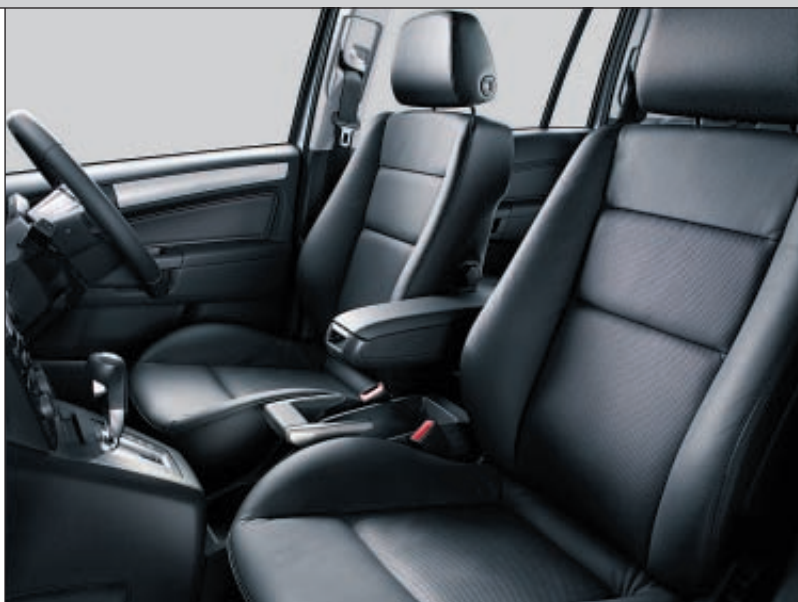

Please note: Insurance groups relate to the 50 group rating.

2.2i 16v Direct model illustrated features automatic transmission and two-coat metallic paint, optional at extra cost.



SRI and SRI with Exterior Pack

SRI

Standard features include:

- Anti-lock braking system
- Six airbags
- Air conditioning
- Electric front windows

Additional features over and above Exclusiv model include:

- 17-inch five-spoke alloy wheels
- Remote control ultrasonic security alarm
- Electronic Stability Programme (ESP-plus) with traction control
- Sports suspension
- Sport switch
- Dark-tinted rear glass
- Electric rear windows
- Matt chrome-effect centre console
- Front fog lights
- Multi-function trip computer
- Sports front seats with driver's armrest
- Driver's seat with tilt and lumbar adjustment
- Leather-covered three-spoke sports steering wheel
- Rear roof spoiler
- Sunglasses holder
- Alloy-effect roof rails

Additional features for SRi models with Exterior Pack (illustrated left):

- 18-inch five-spoke alloy wheels
- VXR Styling Pack One

Zafira SRi model illustrated left features two-coat pearlescent paint, optional at extra cost.



Model illustrated left features two-coat pearlescent paint, optional at extra cost.

 **Satellite navigation system/CD player with MP3 format/auxiliary-in socket/stereo radio/colour graphic information display (CD 70)*.**

**Optional at extra cost.*



Engine availability	Insurance groups (ABI)
1.8i 16v VVT	16E
1.9CDTi (120PS)	18E
1.9CDTi (120PS) Automatic	18E
1.9CDTi 16v (150PS)	18E
1.9CDTi 16v (150PS) Automatic	18E

Please note: Insurance groups relate to the 50 group rating.

Vauxhall options and accessories are all about choice – selecting your new car, then personalising it to suit yourself. There's a choice of factory-fitted options and a huge range of retailer-fit accessories. You can also choose styling products from the VXR range as well as auto design specialist Irmischer International. Available individually or in special packs at great prices. You'll find further information on the following pages or just ask your Vauxhall retailer for more details.



VXR Styling

Inspired by our racing heritage, VXR styling products come with all the same experience, knowledge and passion for style and performance. They put the accent firmly on quality and exclusivity, with a winning edge. And they add flair, personality and excitement to every Zafira model. VXR styling products are available as a factory-fit option pack or accessories fitted by your Vauxhall retailer.



◀▶ **VXR Styling Pack.** Breathe some extra style into your Zafira with a front lower spoiler, side sills, rear roof spoiler* (above) and rear lower skirt. These items are also available separately as retailer-fit accessories.

**Standard on SRI.*

▶ Panoramic Roof Pack.**

- Four glass roof panels
- Roof mounted storage console for front and rear passengers
- Alloy-effect roof rails
- Heat-reflective windscreen

***Not available in conjunction with Olympic White exterior colour. Deletes sunglasses holder where fitted.*



▼ Towing Pack.

- Detachable tow bar[†]
- Trailer stability programme
- Hill Start Assist^{††} (HSA)
- Tyre deflation detection system^{††}
- Cruise control

*†Requires adaptor for UK electrics.
††Not available with automatic transmission.*

OPTION PACKS INCLUDE:

Life/Exclusiv Plus Pack.

- 16-inch 10-spoke alloy wheels
- Front fog lights

Seat Comfort Pack One.

- Driver's seat tilt and lumbar adjustment

Seat Comfort Pack Two.

- Front passenger's seat height, tilt and lumbar adjustment

Leather Pack.

- Leather seat facings on front and second row seats. Third row trimmed in Morrocana.
- Electrically heated sports front seats with tilt and lumbar adjustment
- Front passenger's seat height adjuster

◀ FlexOrganiser® Pack.

- 3D storage net
- Side net pocket
- Four side rail hooks
- Four side rails



▼ Remote control security alarm.

Standard on Zafira SRi and optional on most other models, this advanced ultrasonic system monitors against intrusion to the interior, doors, tailgate and bonnet. It works even if the car's battery is flat or the wires are cut, and can be armed and disarmed via the car's remote control deadlocking key.



◀ Automatic transmission.

The electronically-controlled, six-speed automatic has an adaptive driving function and a Winter mode, which selects third gear for standing starts in slippery conditions. It's available on both 1.9CDTi diesels. A four-speed automatic is available on 2.2i 16v Direct models.

INDIVIDUAL OPTIONS INCLUDE:

- Adaptive Forward Lighting (AFL)
- Interactive Driving System (IDS) with Continuous Damping Control (CDC)
- Electronic Stability Programme-plus (ESP-plus)
- Mobile phone system with Bluetooth[†]
- Twin Audio[®]††
- Satellite navigation system/CD player with MP3 format/auxiliary-in socket/stereo radio/colour graphic information display (CD 70)
- Alloy wheels
- Front and rear parking distance sensors

▶ Keyless entry and start. Simply carry the unique system key fob in your pocket or handbag and the car will automatically unlock as you operate a door or the tailgate. To start the engine, you depress the brake pedal and push the start button on the centre console and to stop the engine, simply press the button again.



†Please refer to the online Vauxhall Car and Accessory Price Guide for a list of phone-specific cradles.

††Does not include headsets. Fitted with industry standard 3.5mm audio sockets.

Vauxhall accessories are the right choice for your Zafira. Whatever you're into, there's certain to be a Vauxhall accessory with your name on it; all fitted by trained Vauxhall professionals. We've only featured a small selection of what's available here, so please check with your Vauxhall retailer for accessory availability information or visit our website at www.vauxhall-accessories.com



▲ Floor mats. A range of floor mats including rubber, velour and deluxe velour are available for your Zafira. Each come with their own fixing points which help keep them firmly in place. The rubber mats are available as a front pair or set of four rears whilst all other variants are supplied in sets of six.

▼ Base carrier. The Vauxhall roof rack system begins with a base carrier. It comprises two T-track bars which support a wide range of attachments from Thule including bicycle carriers and a choice of high-capacity roof boxes (available separately). Each carrier is supplied with locks for security.



▶ Rear parking distance sensors. Activated automatically as you select reverse, this clever system beeps faster the closer you get to an obstruction, changing to a continuous tone at 300mm away.

▶ Dog guard with space divider grid*. Designed to fit Zafira models, the heavy-duty steel dog guard helps keep your pet secure and protects passengers in the event of sudden braking. The space divider grid (sold separately) allows luggage to be stored on one side, and the dog to travel on the other.



**The space divider grid can only be used in conjunction with the dog guard. N.B. Dog guard requires fitting kit (retailer-fit only) if vehicle is not equipped with the optional factory-fit vertical load restraining net.*



FURTHER ACCESSORIES AVAILABLE INCLUDE:

- Thatcham approved alarm system
- Cargo liner
- Mudflaps
- Headlight protectors
- Electrically chilled 12-litre cool bag
- Thule bike carrier
- Thule alloy ski carrier
- Tow bar
- Anti-slip mat
- Steering wheel security bar
- Child seats
- Privacy shades
- Alloy wheels

VAUXHALL ACCESSORY PACKS

Vauxhall accessory packs bring together a selection of essential accessories at great prices, helping you to protect your car and equipping you for roadside emergencies.

Irmscher

Styling

Developed in conjunction with auto design specialists Irmscher International, Zafira styling accessories perfectly complement the vehicle's lines, as well as being manufactured to the same exacting standards as the car itself.



▶ Irmscher sports silencers.

For distinctive looks (with chrome-plated tailpipes) and a sportier exhaust note, these split oval design tailpipes are the perfect choice for your Zafira.



▲▶ Protection Pack.

- Velour mats
- Mudflaps
- Cargo liner



◀ Irmscher alloy wheels. They're the perfect way to personalise your Zafira. With a huge range to choose from (style illustrated is Stila), and sizes from 16 to 19 inches, you're sure to find one to suit your style and budget. And don't forget to ask about our accessory wheel locking kits too.



◀ Safety Pack.

- First aid kit
- Warning triangle
- Hi-visibility vest

▶ Cross hatch grille. Being different is easy with the cross hatch front grille from Irmscher. Featuring an aluminium upper strip with a laser-etched 'Irmscher' logo it adds style and individuality.



ZAFIRA VXR

This is extra-sensory stimulation. Cars with soul and power to make you feel alive, electrified and inspired. A range of driver-focused, performance machines for the road, born on the track.





Exterior features include:

- > 18-inch alloy wheels (far right)
- > 19-inch alloy wheels with anthracite inner, optional at extra cost (right)
- > VXR honeycomb sports front grille and air dam/bumper
- > VXR roof spoiler
- > VXR side sills
- > VXR rear bumper
- > VXR dual branch chrome trapezoidal exhaust tailpipes



DISCOVER 7.2^{SEC}
0-60^{MPH}



 Fog lights.

 Alloy pedals.

Interior features include:

- > Recaro sports front seats with leather-trimmed side bolsters
- > Keyless entry and start
- > Alloy pedals
- > Air conditioning
- > VXR alloy-effect door sill covers
- > Three-spoke leather-covered sports steering wheel with VXR logo





ZAFIRA VXR.

Having a family didn't stop you having a life. You still ride, play, ski or whatever it is that sets you free. And you still want to drive, not just travel. What you need is a seven-seat performance car. Cue Zafira VXR. Same compact MPV format. But a whole new attitude. No other MPV looks this good. Enough said?

For more information on the Zafira VXR please ask your Vauxhall retailer for a copy of the latest VXR range brochure.

Zafira comes in 9 different exterior colours. And each one suits the car beautifully. Every trim combination – cloth or leather – has been carefully selected to complement whatever colour you choose.

Due to the limitations of the printing process the colours reproduced may vary slightly from the actual paint colour or trim material. As a result they should be used as a guide only. Vehicle illustrated is a non-specific model.

Your Vauxhall retailer has a comprehensive display of all our paint samples and trim swatches.

Olympic White – solid



Power Red – solid (two-coat)



Sovereign Silver – metallic**



Silver Lightning – metallic**



Metro Blue – metallic**



Technical Grey – metallic**



Panacotta – pearlescent**



Ultra Blue – pearlescent**



Black Sapphire – pearlescent**





◀ Alpha cloth – Charcoal
EXPRESSION/LIFE



◀ Twist cloth – Charcoal
EXCLUSIV

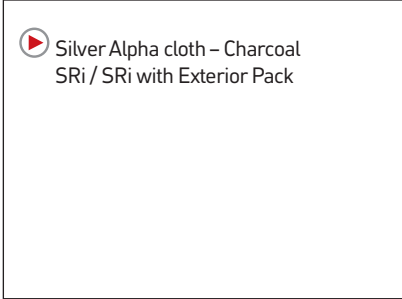

▶ Silver Alpha cloth – Charcoal
SRi / SRi with Exterior Pack



▶ Silver Alpha cloth/
Morrocana – Charcoal
DESIGN

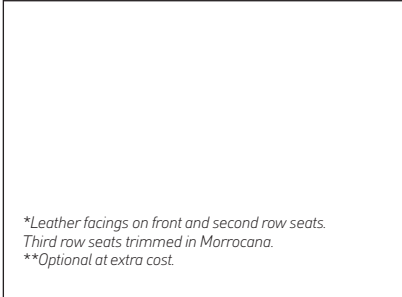

◀ Leather – Charcoal*
ELITE / SRi** / SRi with Exterior Pack**

*Leather facings on front and second row seats.
Third row seats trimmed in Morrocana.
**Optional at extra cost.

Contents

Equipment

Safety Security	38
-----------------	----

Interior features Facia, instruments and controls	39
--	----

Seating and upholstery Wheels and tyres	40
--	----

Mechanical Exterior and convenience features	41
---	----

Option packs	42
--------------	----

Audio, communication and navigation	44
-------------------------------------	----

Technical data

Engines	46
---------	----

Performance, fuel economy and emissions	47
---	----

Vauxhall Assistance and warranties	48
------------------------------------	----

Optional transmissions	
------------------------	--

Steering	
----------	--

Brakes	
--------	--

Suspension	
------------	--

Body	
------	--

Fuel tank capacity	
--------------------	--

Weights and towing data	49
-------------------------	----

Keyless entry and start	
-------------------------	--

Exterior dimensions	50
---------------------	----

Luggage capacities	
--------------------	--

Loadspace dimensions	
----------------------	--

Features explained	51
--------------------	----

Safety

Standard features • Driver's and front passenger's airbags • Full-size curtain airbags (front and second-row seating) • Front seat side-impact airbags • Pedal release system – Reduces potential injury to the driver's legs and feet during a severe frontal impact • Laminated windscreen • Side-impact protection beams • Energy-absorbing steering column

• Child-proof locks on rear doors • ISOFIX child seat restraint system for outer second-row seats (does not include child seat) – Secures ISOFIX child safety seats to the vehicle itself, virtually eliminating the dangers that can result from improper installation

• Anti-lock Braking System (ABS) • Electronic Brakeforce Distribution (EBD) • Cornering Brake Control (CBC) • Emergency Brake Assist (EBA)

• Pyrotechnic front body-lock seatbelt pretensioner system – Tightens the seatbelt during the early stages of a frontal impact • Front seatbelt force limiters – Reduce the loading on the occupants' chests by releasing the belts very slightly, if the force exceeds a specified limit, in a frontal impact • Height-adjustable head restraints on all seats • Inertia-reel lap and diagonal seatbelts on all seats

Additional features

	Exp.	Life	Excl.	Design	Elite	SRI	SRI XP
Electronic Stability Programme-plus (ESP-plus) with traction control – see D2 on page 51	○	○ ¹	○ ¹	○ ²	○ ²	●	●
Tyre deflation detection system			□	□	□	□	□
Hill Start Assist (HSA)			□	□	□	□	□

Security

Standard features • Remote control central deadlocking (doors, tailgate and fuel flap) • 'Key left in ignition' audible warning • Electronic engine deadlock immobiliser • Locking wheel bolts for alloy wheels (where fitted) • Electronic theft protection for audio equipment

Additional features

	Exp.	Life	Excl.	Design	Elite	SRI	SRI XP
Keyless entry and start system – see D1 on page 49			○	○	○	○	○
Remote control ultrasonic security alarm system		○ ³	○	○	○	●	●

Interior features

Standard features • Air blend heater with four-speed fan and illuminated controls • Interior pollen filter • Interior odour-reducing activated charcoal filter • Air recirculation system with activation light • Second-row passenger compartment heating outlets • Drinks holder in centre console • Front and rear door pockets • Front sill storage bins • Drinks holders in second-row door pockets and third-row seat side armrests • Latched storage lockers in luggage compartment • 12-volt auxiliary power socket in luggage compartment • Retractable luggage compartment cover

Additional features	Exp.	Life	Excl.	Design	Elite	SRi	SRi XP
Air conditioning		● ⁴	●	●		●	●
Electronic Climate Control (ECC) with graphic information display			○		●	○	○
Third-row passenger compartment reading lights and front map-reading lights integral with courtesy light			●	●	●	●	●
Charcoal-effect inserts on facia and doors	●	●					
Matt chrome-effect centre console	●	●	●			●	●
Matt chrome-effect inserts on facia and doors			●				
Maze chrome-effect inserts on facia and doors						●	●
Piano black-effect centre console				●	●		
Satin chrome-effect inserts on facia and doors				●	●		
Brushed aluminium door sill covers				●	●	●	●
Electro-chromatic anti-dazzle rear-view mirror				●	●		
Driver's sunglasses holder ⁵				●	●	●	●
Vertical load-restraining net	○	○	○	○	○	○	○

Facia, instruments and controls

Standard features • Steering column adjustable for reach and rake • Rev counter • Electronic odometer and trip odometer • Digital clock with automatic RDS time adjustment • Service-due indicator • Multi-function display panel showing time, date, audio information and outside air temperature (with ice warning function) • Electrical accessory socket

Additional features	Exp.	Life	Excl.	Design	Elite	SRi	SRi XP
Multi-function trip computer				●	●	●	●
Black instrument dials	●	●	●	●	●		
Black instrument dials with chrome edging						●	●
Three-spoke steering wheel	●	●	●				
Leather-covered three-spoke steering wheel				●	●		
Leather-covered three-spoke sports steering wheel						●	●
Cruise control			○	○	●	○	○
Sport switch		● ⁶	● ⁶	● ⁷	● ⁷	●	●



Sport switch.

- = Standard equipment.
- = Optional at extra cost.
- = Only available as part of an extra-cost option pack (see page 42 for details).

Exp. = Expression.

Excl. = Exclusiv.

SRi XP = SRi with Exterior Pack.

1 = Standard on 2.2i 16v Direct automatic model.

2 = Standard on 2.2i 16v Direct/1.9CDTi 16v (150PS) models.

3 = Includes map reading light, sunvisors with illuminated vanity mirrors and rear reading lights.

4 = Non-air conditioned 1.6i 16v VVT models also available.

5 = Deleted if optional Panoramic Roof Pack is specified.

6 = Standard on 2.2i 16v Direct automatic, fitted in conjunction with Easytronic transmission on 1.8i 16v VVT and automatic transmission on 1.9CDTi (120PS) models.

7 = Standard on 2.2i 16v Direct/1.9CDTi 16v (150PS), fitted in conjunction with Easytronic transmission on 1.8i 16v VVT and automatic transmission on 1.9CDTi (120PS) models.



18-inch five-spoke alloy wheels (SRi).



17-inch 10-spoke alloy wheels.



17-inch five-spoke alloy wheels.

Seating and upholstery (see pages 37 for more details)

Standard features • Flex7® seating system • Reclining front seats • Driver's seat height adjuster • 40/20/40 split-folding second-row seat back • Second-row seats with sliding function plus fold and stow facility • Multi-function fold-down second-row centre seat • Two individual fold-flat third-row seats • Carpeted passenger compartment, load area floor and rear seat backs

Additional features	Exp.	Life	Excl.	Design	Elite	SRi	SRi XP
Alpha cloth seat trim	●	●					
Twist cloth seat trim			●				
Silver Alpha cloth seat trim with Morrocana-trimmed side bolsters				●			
Silver Alpha cloth seat trim						●	●
Leather seat facings on front and second-row seats, Morrocana seat facings on third-row seats					●	□	□
Sports front seats					●	●	●
Driver's seat with tilt and lumbar adjustment			□	●	●	●	●
Front passenger's seat with tilt and lumbar adjustment			□	□	●	□	□
Driver's armrest				●	●	●	●
Heated front seats					●	□	□
Storage pockets on front seat backs			●	●	●	●	●

Wheels and tyres

Features	Exp.	Life	Excl.	Design	Elite	SRi	SRi XP
16-inch steel wheels with flush covers and 205/55 R 16 ultra-low profile tyres	●	●					
16-inch Structure wheels with 205/55 R 16 ultra-low profile tyres			●				
16-inch 10-spoke alloy wheels with 205/55 R 16 ultra-low profile tyres and locking bolts		□	□				
16-inch seven twin-spoke alloy wheels with 205/55 R 16 ultra-low profile tyres and locking bolts				● ⁸	● ⁸		
17-inch 10-spoke alloy wheels with 225/45 R 17 ultra-low profile tyres and locking bolts			○ ⁹	● ²	● ²		
18-inch five-spoke alloy wheels with 225/40 R 18 ultra-low profile tyres and locking bolts (see pages 4/5 for illustration of wheel style)				○ ^{10,11}			
17-inch five-spoke alloy wheels with 225/45 R 17 ultra-low profile tyres and locking bolts						●	
18-inch five-spoke alloy wheels with 225/40 R 18 ultra-low profile tyres and locking bolts						○ ¹¹	●
Steel spare wheel (deletes 12-volt auxiliary power socket in luggage compartment)	○	○	○	○ ¹²	○	○ ¹²	
Emergency tyre inflation kit in lieu of spare wheel	●	●	●	●	●	●	●

Mechanical

Features	Exp.	Life	Excl.	Design	Elite	SRi	SRi XP
Five-speed manual gearbox (1.6i 16v VVT/1.8i 16v VVT)	●	●	●	●	●	●	●
Six-speed manual gearbox (2.2i 16v/1.7CDTi 16v/1.9CDTi)		●	●	●	●	●	●
Five-speed Easytronic transmission (1.8i 16v VVT)		○	○	○	○		
Four-speed automatic transmission (2.2i 16v)		○	○	○	○	○	○
Six-speed automatic transmission (1.9CDTi)		○	○	○	○	○	○
Sports suspension				● ²	● ²	●	●
Interactive Driving System-plus (IDS-plus) with Continuous Damping Control (CDC) – see D3 on page 51						○	○

Exterior and convenience features

Standard features • Green-tinted glass • Electrically operated front windows with safety autoreverse and one-touch facility • Intermittent rear window wash/wipe • Electrically adjustable door mirrors • Electric headlight beam levelling • H7 halogen headlights • Body-colour door mirrors • Body-colour bumpers

Additional features	Exp.	Life	Excl.	Design	Elite	SRi	SRi XP
Folding key			●	●	●	●	●
Rain-sensitive windscreen wipers/Automatic Lighting Control (ALC)				●	●		
Dark-tinted glass (excludes windscreen and front door windows)				●	●	●	●
Electrically operated rear windows with safety autoreverse				●	●	●	●
Black foil on door pillars (not available with Black Sapphire pearlescent paint)			●	●	●	●	●
Black roof rails ¹³		●	●				
Alloy-effect roof rails ¹³			□	●	●	●	●
Front fog lights		□	□	●	●	●	●
Two-coat metallic or pearlescent paint		○	○	○	○	○	○
Electrically heated door mirrors			●	●	●	●	●
Electrically foldable door mirrors				○	○	○	○
Black side-protection mouldings	●	●					
Body-colour side-protection mouldings/door handles/tailgate handle			●	●	●	●	●
Body-colour rear roof spoiler			□	□	□	●	●
VXR Styling Pack – see page 42 for details			□ ¹⁴	□ ¹⁴	□ ¹⁴	□	●
Dark-style headlights	●	●				●	●
Chrome-effect headlights			●	●	●		
Adaptive Forward Lighting (AFL) incorporating dark-style bi-xenon headlights with dynamic beam levelling and high-pressure headlight washers – see D4 and D5 on page 51			○ ¹⁵	○	○	○	○
Front and rear parking distance sensors			○	○	○	○	○
Heat-reflective windscreen			□	□	●	□	□



Folding key.

● = Standard equipment.
○ = Optional at extra cost.
□ = Only available as part of an extra-cost option pack (see page 42 for details).

Exp. = Expression.

Excl. = Exclusiv.

SRi XP = SRi with Exterior Pack.

2 = Standard on 2.2i 16v Direct/1.9CDTi 16v (150PS) models.

8 = Standard on 1.8i 16v VVT/1.7CDTi 16v/1.9CDTi (120PS) models.

9 = Only available in conjunction with ESP-plus.

10 = Only available on 2.2i 16v Direct automatic/1.9CDTi 16v (150PS) models.

11 = Not available on 1.9CDTi 16v (150PS) automatic model with Panoramic Roof Pack.

12 = Not available on models fitted with optional 18-inch alloy wheels.

13 = Must be used with separate base carrier (available as a Vauxhall accessory) if luggage is to be carried on the roof.

14 = Not available on 1.7CDTi 16v models.

15 = AFL includes front fog lights on Exclusiv models.

● = Standard equipment.
 ○ = Optional at extra cost.
 Exp. = Expression.
 Excl. = Exclusiv.
 SRi XP = SRi with Exterior Pack.

9 = Only available in conjunction with ESP-plus.
 13 = Must be used with separate base carrier (available as a Vauxhall accessory) if luggage is to be carried on the roof.
 14 = Not available on 1.7CDTi 1.6v models.
 16 = Not available with Olympic White exterior colour. Deletes sunglasses holder where fitted.
 17 = Not available on 1.9CDTi 1.6v (150PS) automatic SRi with Exterior Pack models or in conjunction with 18-inch alloy wheels on 1.9CDTi 1.6v (150PS) automatic SRi models.
 18 = Only available in conjunction with Seat Comfort Pack One.
 19 = Only available in conjunction with Electronic Stability Programme-plus. Requires 13-pin adaptor (available as a Vauxhall accessory). When Towing Pack is supplied in conjunction with automatic transmission HSA and tyre deflation detection system are deleted.

Option packs

	Exp.	Life	Excl.	Design	Elite	SRi	SRi XP
Plus Pack ● 16-inch 10-spoke alloy wheels with 205/55 R 16 ultra-low profile tyres and locking bolts ● Front fog lights		○	○				
Leather Pack ● Leather seat facings on front and second-row seats, Morrocana seat facings on third-row seats ● Electrically heated sports front seats with tilt and lumbar adjustment ● Front passenger's seat height adjuster					●	○	○
Panoramic Roof Pack ¹⁶ ● Four glass roof panels ● Roof-mounted storage console for front and rear passengers ● Alloy-effect roof rails (Exclusiv) ¹³ ● Heat-reflective windscreen			○ ⁹	○ ⁹	○ ⁹	○ ¹⁷	○ ¹⁷
Seat Comfort Pack One ● Driver's seat with tilt and lumbar adjustment			○	●	●	●	●
Seat Comfort Pack Two ● Front passenger's seat with tilt, height and lumbar adjustment			○ ¹⁸	○	●	○	○
Towing Pack ¹⁹ ● Trailer stability programme ● Hill Start Assist (HSA) ● Tyre deflation detection system ● Cruise control ● Detachable tow bar			○	○	○	○	○
VXR Styling Pack ● Body-colour lower front spoiler/rear lower skirt/rear roof spoiler (standard on SRi) and side sills			○ ¹⁴	○ ¹⁴	○ ¹⁴	○	●
FlexOrganiser® Pack ● 3D storage net ● Side net pocket ● Four side rail hooks ● Four side rails			○	○	○	○	○

Plus Pack

- 16-inch 10-spoke alloy wheels with 205/55 R 16 ultra-low profile tyres and locking bolts
- Front fog lights



Leather Pack

- Leather seat facings on front and second-row seats, Morrocana seat facings on third-row seats
- Electrically heated sports front seats with tilt and lumbar adjustment
- Front passenger's seat height adjuster



Panoramic Roof Pack¹⁶

- Four glass roof panels
- Roof-mounted storage console for front and rear passengers
- Alloy-effect roof rails (Exclusiv)¹³
- Heat-reflective windscreen



Seat Comfort Pack One

- Driver's seat with tilt and lumbar adjustment



Seat Comfort Pack Two¹⁸

- Front passenger's seat with tilt, height and lumbar adjustment



Towing Pack¹⁹

- Trailer stability programme
- Hill Start Assist (HSA)
- Tyre deflation detection system
- Cruise control
- Detachable tow bar

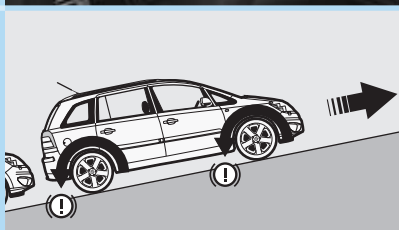

VXR Styling Pack

- Body-colour lower front spoiler/rear lower skirt/rear roof spoiler (standard on SRi) and side sills



FlexOrganiser[®] Pack

- 3D storage net
- Side net pocket
- Four side rail hooks
- Four side rails



FlexOrganiser[®] accessories

Vauxhall also offers a range of FlexOrganiser[®] features as part of its comprehensive collection of accessories.

For details of FlexOrganiser[®] accessories, shown right, please consult your Vauxhall retailer.



● = Standard equipment.
 ○ = Optional at extra cost.
 Exp. = Expression.
 Excl. = Exclusiv.
 SRi XP = SRi with Exterior Pack.

- 3 = Includes map reading light, sunvisors with illuminated vanity mirrors and rear reading lights.
- 20 = Not available in conjunction with VXR Styling Pack.
- 21 = Only available in conjunction with VXR Styling Pack.
- 22 = Steering wheel mounted audio controls are also included on Life models.
- 23 = Only available in conjunction with optional audio units. Deletes auxiliary-in socket (where fitted).
- 24 = Deletes auxiliary-in socket.



Steering wheel mounted audio controls.

Audio, communication and navigation

Features	Exp.	Life	Excl.	Design	Elite	SRi	SRi XP
CD player/stereo radio (CD 30) ● CD player ● AM/FM stereo radio with 24 station presets ● RDS with Traffic Programme ● Remote display ● 17 watts per channel output ● 6 speakers	●	●	●	●		●	●
CD player with MP3 format/stereo radio (CD 30 MP3) ● CD player with MP3 format ● Auxiliary-in socket ● AM/FM stereo radio with 24 station presets ● RDS with Traffic Programme ● Remote display ● 20 watts per channel output ● 7 speakers		○	○	○	●	○	○
CD autochanger with MP3 format/DAB stereo radio (CDC 40 DAB) (deletes auxiliary-in socket, where fitted) ● Integral six-disc CD autochanger with MP3 format ● AM/FM/DAB (Digital Audio Broadcast) stereo radio with 36 station presets ● RDS with Traffic Programme ● Remote graphic information display ● 35 watts per channel output ● 7 speakers			○ ²⁰	○ ²⁰	○ ²⁰		
CD autochanger with MP3 format/stereo radio (CDC 40) (deletes auxiliary-in socket, where fitted) ● Integral six-disc CD autochanger with MP3 format ● AM/FM stereo radio with 36 station presets ● RDS with Traffic Programme ● Remote graphic information display ● 35 watts per channel output ● 7 speakers			○ ²¹	○ ²¹	○ ²¹	○	○
Satellite navigation/CD player with MP3 format/stereo radio (CD 70) ● Satellite navigation system ● CD player with MP3 format ● Auxiliary-in socket ● AM/FM stereo radio with 40 station presets ● RDS with Traffic Programme ● Remote colour display ● 20 watts per channel output ● 7 speakers		○ ^{3,22}	○	○	○	○	○
Rear seat Twin Audio [®] system			○ ²³	○ ²³	○ ²⁴	○ ²³	○ ²³
Mobile phone system with Bluetooth [®] (does not include phone or cradle)		○ ^{3,22}	○	○	○	○	○
Steering wheel mounted audio controls			●	●	●	●	●
Roof-mounted flexible aerial	●	●	●	●	●	●	●

Twin Audio[®] system

The Twin Audio[®] system allows the two rear passengers to listen to the same music source (i.e. radio or CD) through personal headphones, independently of one another and each with their own volume controls.

They are also free to select CD mode while the front occupants are tuned into the radio (or vice-versa) and make full use of functions like track skip and autosearch.



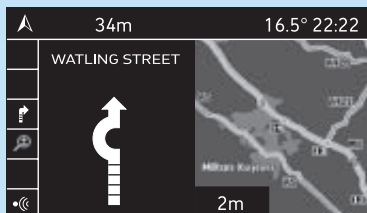

Satellite navigation

The CD 70 satellite navigation system uses the international network of GPS (Global Positioning System) satellites, linked to a comprehensive CD-ROM mapping system, to determine your precise location and guide you to your chosen destination virtually anywhere in mainland Britain.

Vauxhall's satellite navigation systems have been widely acclaimed for their ease of use and high level of information. There are three screen styles – pictographic, split-screen pictographic/map and map only. The split-screen facility displays the route as a map, while directional arrows give immediate information about road junctions. The display also allows you to vary the map scale – close-up for town driving or a wider scale for long distances, if required.

The CD 70 also features Traffic Message Channel (TMC), a specific application of RDS used for broadcasting real-time traffic information, delivered to the driver either visually or verbally. TMC can also offer dynamic route guidance – alerting the driver to a problem on the planned route and calculating an alternative route to avoid the incident.

CD 70 standard features

- Split-screen facility displaying directional symbols and route on map
- Audio/voice direction guidance prompt
- Automatic re-routing on request
- CD-ROMs available for all major European countries
- Option of destination entry via partial postcode
- Display of estimated time remaining and distance to destination
- Points of interest, including attractions, petrol stations, airports, hotels, restaurants, etc
- Store up to 100 personal destinations
- Last 10 destinations stored automatically
- Traffic Message Channel (TMC)

Digital Audio Broadcast (DAB) facility

Now widely available in the UK, digital audio broadcasts offer the user a variety of advantages over traditional FM, starting with the digital quality sound which is immune to any hiss or crackle.

You'll often find a broader range of stations on offer too, many of which are not available on FM, and listening to them couldn't be easier – you simply select the station, by name, from the displayed list, thus removing the need to retune or look for stations when travelling around. Some stations will even display the artists' names and song titles on the car's graphic display, while they're played.

MP3 CD player

An MP3 is a compressed sound or music file and, due to its small size, it takes up less space on a compact disc, which means that more tracks can be recorded onto a CD. It's possible to fit almost 10 hours of music onto one CD, and, in a way, turns a single-disc CD/MP3 player into a multi-disc autochanger.

Mobile phone system with Bluetooth®

Vauxhall's optional factory-fit dual-band mobile phone system has been considerably enhanced. Now fully integrated into the audio and communication system, it also features voice control and will connect wirelessly to phones with Bluetooth® technology.

All the required information is displayed on the graphic information display when a mobile phone is in use, while the menus are easily navigated by either the steering wheel audio controls or the multi-function button on the radio. Certain functions can also be controlled by voice activation.

The mobile phone system can be further enhanced by fitting a phone-specific cradle, available as a Vauxhall Accessory. The cradle offers a secure location for your phone, while simultaneously charging the phone's battery and connecting its antenna to the car's external aerial. A list of compatible cradles is featured in the online Vauxhall Car and Accessory Price Guide.

Auxiliary-in socket

The auxiliary-in socket allows you to connect your portable MP3 music player directly into the car's audio system. All you need is your music player and a suitable connecting lead and you can listen to all your favourite tunes through your car's speaker system.

When using an MP3 player in the car the majority of the controls, such as track selection, remain solely on the player, while only the volume is controlled via the car's regular audio controls.

NB: Auxiliary-in socket is not available in conjunction with CDC 40 audio units.



CD 70 satellite navigation system.



Mobile phone system with Bluetooth®.



High-performance petrol engines.



53.3mpg
1.7CDTi 16v
ecoFLEX engine
offers great
economy and low
emissions

Petrol engines

	1.6i 16v VVT ECOTEC-4	1.8i 16v VVT ECOTEC-4	2.2i 16v Direct ECOTEC-4 aluminium
Capacity	1598cc	1796cc	2198cc
Maximum power	115PS (85kW) @ 6000rpm	140PS (103kW) @ 6300rpm	150PS (110kW) @ 5600rpm
Maximum torque	155Nm (114 lb.ft.) @ 4000rpm	175Nm (129 lb.ft.) @ 3800rpm	215Nm (159 lb.ft.) @ 4000rpm
Configuration	4 cylinders, 4 valves per cylinder, double overhead camshafts		
Fuel/induction system	Naturally aspirated Variable Valve Timing (VVT) Multi-point sequential fuel injection	Naturally aspirated Variable Valve Timing (VVT) Multi-point sequential fuel injection	Naturally aspirated Direct fuel injection
Service intervals	20,000 miles or 1 year (whichever occurs sooner)		
Benefit in kind company car taxation – 2009/10 (2010/11) tax years			
Manual	19% (20%)	23% (24%)	27% (28%)
Easytronic/automatic	–	22% (23%)	28% (29%)

Diesel engines

	1.7CDTi 16v ECOTEC-4 Turbo diesel	1.9CDTi (120PS) ECOTEC-4 Turbo diesel	1.9CDTi 16v (150PS) ECOTEC-4 Turbo diesel
Capacity	1686cc	1910cc	1910cc
Maximum power	110PS (81kW) @ 3800rpm	120PS (88kW) @ 3500rpm	150PS (110kW) @ 4000rpm
Maximum torque	260Nm (192 lb.ft.) @ 2300rpm	280Nm (206 lb.ft.) @ 2000-2750rpm	320Nm (236 lb.ft.) @ 2000rpm
Configuration	4 cylinders, 4 valves per cylinder Double overhead camshafts	4 cylinders, 2 valves per cylinder Single overhead camshaft	4 cylinders, 4 valves per cylinder Double overhead camshafts
Fuel/induction system	Variable geometry turbocharger with intercooler. Common rail fuel injection		
Service intervals	20,000 miles or 1 year (whichever occurs sooner)		
Benefit in kind company car taxation – 2009/10 (2010/11) tax years			
Manual	18% (19%)	22% (23%)	22% (23%)
Automatic	–	28% (29%)	29% (30%)

Performance, fuel economy and emissions

Model	Performance (manufacturer's figures) Acceleration (secs)			Fuel economy mpg (litres/100km)			CO ₂ emissions (g/km)
	Max. speed (mph)	0-60mph	30-50mph (4th gear)	Urban driving	Extra- urban driving	Combined figure	
Manual 5-speed							
1.6i 16v VVT	115	12.5	12.0	31.7 (8.9)	52.3 (5.4)	42.2 (6.7)	159
1.8i 16v VVT	122	10.8	8.1	28.5 (9.9)	47.1 (6.0)	38.2 (7.4)	177
Manual 6-speed							
2.2i 16v Direct	124	9.9	7.6	25.0 (11.3)	44.1 (6.4)	34.4 (8.2)	197
1.7CDTi 16v ecoFLEX	112	12.6	8.3	43.5 (6.5)	61.4 (4.6)	53.3 (5.3)	139
1.9CDTi (120PS)	116	11.4	6.8	37.2 (7.6)	55.4 (5.1)	47.1 (6.0)	159
1.9CDTi 16v (150PS)	127	9.8	6.0	37.2 (7.6)	55.4 (5.1)	47.1 (6.0)	159
Easytronic 5-speed							
1.8i 16v VVT	122	12.1	–	29.1 (9.7)	48.7 (5.8)	39.2 (7.2)	172
Automatic 4-speed							
2.2i 16v Direct	118	10.8	–	24.4 (11.6)	42.2 (6.7)	33.2 (8.5)	204
Automatic 6-speed							
1.9CDTi (120PS)	113	11.7	–	29.4 (9.6)	51.4 (5.5)	40.4 (7.0)	186
1.9CDTi 16v (150PS)	123	10.0	–	28.8 (9.8)	49.6 (5.7)	39.2 (7.2)	191

The fuel consumption figures shown comply with EC directive 1999/100 to provide a realistic indication of fuel consumption by taking into account everyday driving conditions, such as cold starts, acceleration and braking. These figures take account of the vehicle's kerbweight, ascertained in accordance with the above regulation. **Important:** the results given relate to the particular car tested. Driving style, road and traffic conditions, vehicle mileage and standard of maintenance may also affect fuel consumption; therefore the results do not express or imply any guarantee of fuel consumption attainable.

Vauxhall supporting



Smarter driving tips

- **Drive at an appropriate speed:** – Staying within the speed limit increases driver safety, reduces CO₂ emissions and saves fuel. At 70mph you could be using up to 9% more fuel than at 60mph and up to 15% more fuel than at 50mph
- **Drive smoothly at all times:** – Anticipate the ebb and flow of the traffic to avoid harsh acceleration and braking
- **Reduce your revs:** – Change gear earlier to help reduce fuel consumption – try 2500rpm with petrol engines and 2000rpm with diesel
- **Idling is wasting fuel:** – If you're likely to be at a standstill for more than three minutes, switch off the engine to save fuel
- **Regularly check your tyre pressures:** – Under inflated tyres increase CO₂ emissions whilst incorrectly inflated tyres can be unsafe. Always check your handbook for the correct tyre pressure. This will also help to increase the life of your tyres
- **Remove unnecessary items from the car:** – Extra weight increases the engine's workload, whilst roof racks and bike carriers increase wind resistance. All burn more fuel and increase CO₂ emissions

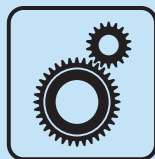

6-SPEED

Six-speed manual and automatic transmissions available



Six-speed automatic transmission.



MacPherson strut front suspension.

Vauxhall Assistance and warranties*

- All new Vauxhalls qualify for a three-year vehicle warranty consisting of a one year/unlimited mileage manufacturer's warranty and a second and third year manufacturer's warranty with a 60,000 miles limitation
- Vauxhall Assistance for 12 months from first registration
- Six years' body panel anti-perforation warranty

* = Warranty is only available on vehicles sourced from General Motors UK Limited. Terms and conditions apply – please see your Vauxhall retailer for details.

Optional transmissions

Five-speed Easytronic transmission –

1.8i 16v VVT models: Easytronic is a five-speed manual gearbox with a fully automatic mode. In manual mode you simply push the lever forward or back to shift gears up or down, while the fascia display tells you what gear you're in. Switch to fully automatic mode and you'll have many of the features of a regular automatic, including kickdown. Since there's no clutch pedal, Easytronic is ideal for effortless town driving.

Four-speed automatic transmission

– **2.2i 16v Direct models:** Electronically controlled with an adaptive driving programme, which tailors its gear changes to match your driving conditions. There is also a winter mode, which selects a higher than normal gear to reduce the possibility of wheelspin in icy conditions.

Six-speed automatic transmission with Active Select function – 1.9CDTi (120/150PS) models:

The electronically controlled adaptive driving programme can tailor gear changes to match your driving conditions, while the winter mode selects a higher than normal gear to reduce the possibility of wheelspin in icy conditions. The Active Select manual mode allows the gear lever to be used like a manual gearbox – you simply push the lever forward or back to change up or down the gears.

Steering

- Electro-hydraulic power-assisted steering
- Turning circle (kerb-to-kerb):
All models – 11.10m (36.4ft)

Brakes

- Anti-lock Braking System (ABS)
- Dual circuit, diagonally split braking system

1.6i 16v VVT

Front ventilated discs: 280mm diameter
Rear discs: 264mm diameter

1.8i 16v VVT

Front ventilated discs: 280mm diameter
Rear discs: 264mm diameter

2.2i 16v Direct

Front ventilated discs: 308mm diameter
Rear discs: 264mm diameter

1.7CDTi 16v

Front ventilated discs: 308mm diameter
Rear discs: 264mm diameter

1.9CDTi (120/150PS)

Front ventilated discs: 308mm diameter
Rear discs: 264mm diameter

Suspension

Front: Independent. Lightweight MacPherson struts with gas-pressure dampers and coil springs. Anti-roll bar. Hydro-formed subframe offers increased lateral stiffness. Hydraulic control arm bushing gives improved insulation from road noise.

- Design/Elite 2.2i 16v Direct/1.9CDTi 16v (150PS) and all SRI models – uprated springs and dampers
- SRI – Interactive Driving System with Continuous Damping Control, optional at extra cost – see **D3** on page 51

Rear: Lightweight torsion beam rear axle with one-piece, hollow cast trailing arms. Built-in anti-roll bar. Progressive-rate double conical mini-block springs and gas-pressure dampers.

- Design/Elite 2.2i 16v Direct/1.9CDTi 16v (150PS) and all SRI models – uprated springs and dampers
- SRI – Interactive Driving System with Continuous Damping Control, optional at extra cost – see **D3** on page 51

Body

- Aerodynamic drag co-efficient: Cd 0.31

Fuel tank capacity

- All models – 58 litres (12.8 gallons)

Weights and towing data kg

	Gross vehicle weight	Max. towing weights Trailer with brakes (without brakes)
1.6i 16v VVT Expression/Life (non-air conditioned)	2075	1000 (750)
1.6i 16v VVT Life/Exclusiv/Design	2090	1000 (750)
1.8i 16v VVT Life/Exclusiv/Design/Elite (inc. Easytronic)	2095	1200* (750)
1.8i 16v VVT SRi	2095	1200 (750)
2.2i 16v Direct Elite	2150	1500 (750)
2.2i 16v Direct Life/Exclusiv/Design/Elite auto.	2175	1500 (750)
1.7CDTi 16v Life/Exclusiv/Design/Elite	2175	1300 (750)
1.9CDTi (120PS) Life/Exclusiv/Design/Elite/SRi	2195	1300 (750)
1.9CDTi (120PS) Life/Exclusiv/Design/Elite/SRi auto.	2225	1400 (750)
1.9CDTi 16v (150PS) Design/Elite/SRi	2205	1500 (750)
1.9CDTi 16v (150PS) Design/Elite/SRi auto.	2235	1500 (750)

* = On models fitted with the optional Easytronic transmission the maximum towing weight for a trailer with brakes is 1300kg.

Gross vehicle weight is the total permissible weight of the vehicle including passengers and their luggage. The **maximum roof rack loading** should not exceed 75kg. The **maximum towing weights** are based on the ability of the car, with two occupants of 75kg each, to restart on a 12% gradient, which is approximately 1 in 8.3, at sea level. At altitudes above 1500 metres, the engine output may drop with a corresponding reduction in towing capability. Any extra weight, such as luggage or additional passengers, should be deducted from the maximum towing weight. With a trailer fully loaded, **maximum noseweight** should not exceed 75kg. Always fit Vauxhall towing attachments and accessories available from your Vauxhall retailer.



1500kg
Maximum
towing weight

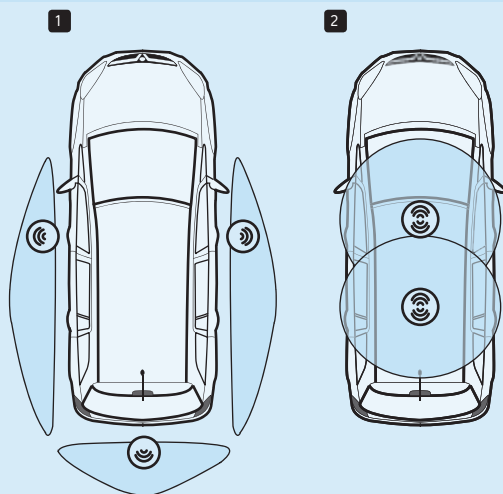

D1

Keyless entry and start

D1. Available as an option, the keyless entry and start system means that the driver need never remove their key fob from their pocket. When approaching the car, sensors in the front door handles and rear bumper **1** detect the driver's proximity and automatically unlock the doors or boot when the handle is pulled.

When in the car, two internal sensors **2** activate the ignition and release the electronic steering lock, enabling the driver to start or stop the engine by pressing the facia-mounted Start/Stop button. As an added safety feature, the engine will only start if the driver presses the foot brake while pushing the Start/Stop button.

Upon leaving the vehicle, the driver can lock it by either pressing a button on the key fob like a conventional system, or by simply touching one of the sensors on the external handles of the front doors.

Additionally the system offers excellent theft protection by its use of sophisticated cryptographic algorithms, while a back-up key is also included for emergency use.

Exterior dimensions millimetres (inches)

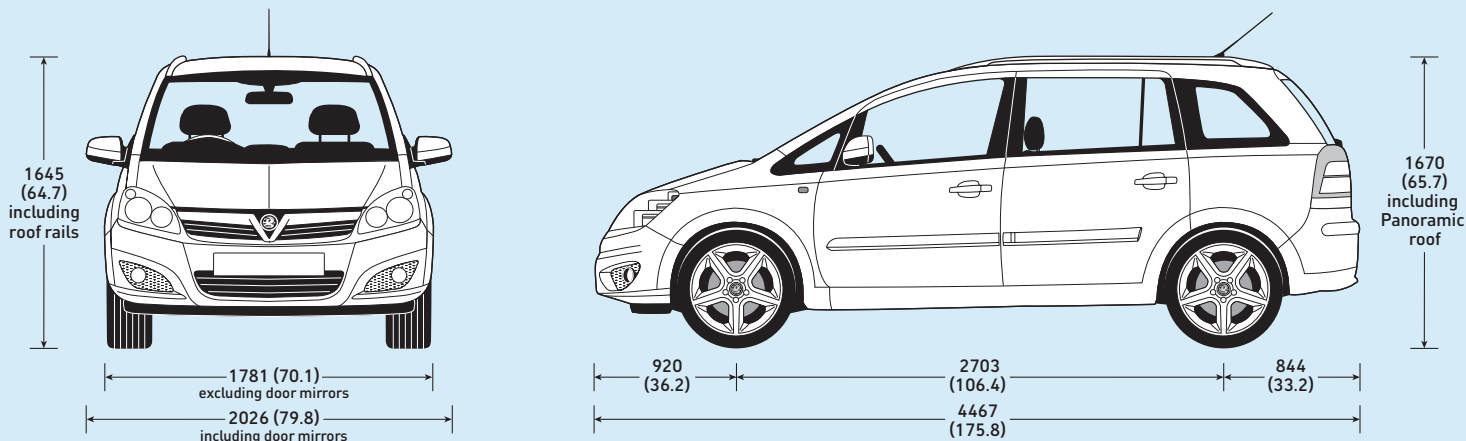

Luggage capacities (measured using the ECIE method)

	litres	cu.ft
Behind third-row, to glass line	140	4.9
Behind second-row, to glass line	645	22.8
Behind front seats, to glass line	1070	37.8
Behind front seats, to roof	1820	64.3

Loadspace dimensions

	mm	inches
Maximum floor length – behind front seats, second-row seat back lowered	1809	71.2
Maximum floor length – behind front seats, second-row seat folded and stowed	1525	60.0
Maximum floor length – behind second-row seat	1088	42.8
Maximum floor length – behind third-row seat	405	15.9
Maximum floor width	1114	43.9
Width between wheel arches	1071	42.2
Tailgate aperture height	893	35.2
Tailgate aperture width	1136	44.7



1820 litres
Maximum luggage capacity

Features explained

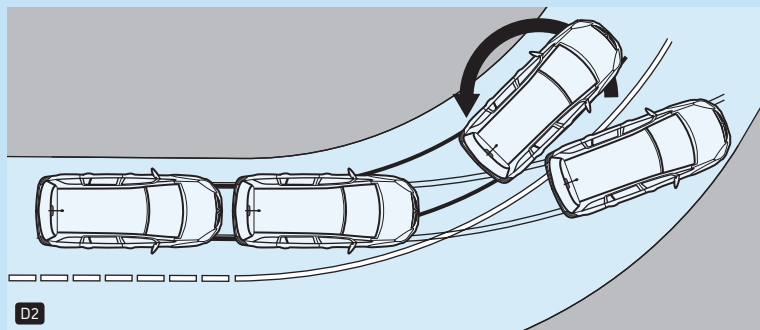

Electronic Stability Programme-plus (ESP-plus)

D2. ESP-plus provides enhanced yaw compensation during understeer or oversteer. It works by monitoring the front and rear of the car and comparing their respective directions of travel with the input through the steering wheel. If the vehicle starts to slide, ESP-plus applies corrective braking to the appropriate wheel, or wheels, compensating for the slide and helping you regain control more rapidly. ESP-plus offers additional safety in the form of two-way traction control, which helps prevent the driving wheels from spinning, under acceleration, on slippery surfaces.

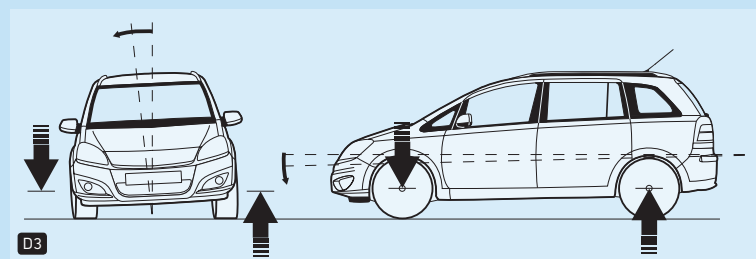

IDS-plus with Continuous Damping Control (CDC)

D3. The Interactive Driving System (IDS-plus) chassis – available on SRi and SRi XP models – offers the Zafira driver an even more sporting driving experience, thanks mainly to the electronic control of the suspension. Pressing the Sport switch activates the CDC function – CDC monitors the roll, pitch and yaw of the car, and changes the rate of damping on each wheel to optimise the handling, effectively stiffening the suspension – but selectively. This means the vehicle will exhibit a reduced rate of roll and pitch, making it more responsive during direction changes and more settled during the braking/turn-in/acceleration transition when cornering. CDC is a major breakthrough in the Zafira segment.

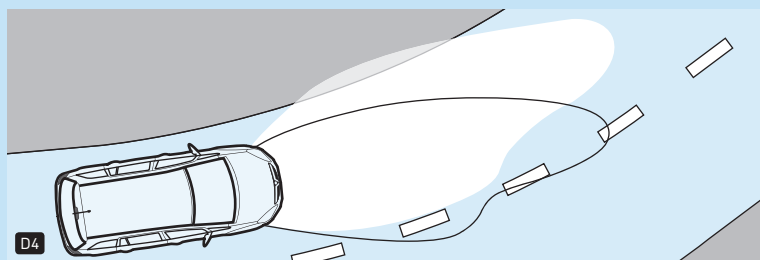

Bi-xenon Adaptive Forward Lighting (AFL)

Adaptive Forward Lighting is a sophisticated new lighting system that allows drivers to see around corners. AFL utilises powerful bi-xenon headlights – which offer up to three times more light output than conventional halogen headlights – to enable the full benefit of the system's advantages to be appreciated. While standard xenon headlights provide only dipped beam lighting (main beam illumination still uses conventional halogen lights), bi-xenon units provide both dipped and main beam from a single lighting unit. The package is completed by high-pressure headlight washers and dynamic beam levelling.

Curve light

D4. Controlled by a combination of steering wheel movement and sensors for the vehicle's speed and yaw angle, the Curve light function allows the headlight beam to move up to 15 degrees left or right of the straight ahead position. This ensures the light is always following the trajectory plotted by the front wheels, rather than simply pointing straight ahead.

Motorway light

D5. At speeds above 65mph, AFL raises the dipped headlight beam to extend the range of vision for increased safety at higher speed. The beam automatically returns to its normal position when the car falls below that speed.

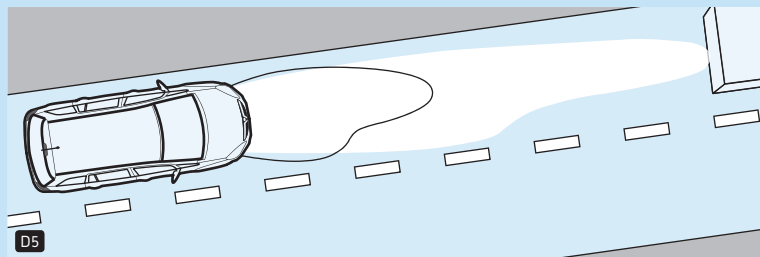

Trust Vauxhall

Protecting the environment

Vauxhall's commitment to the environment is demonstrated by our products' many environmental awards, won both through the use of more recycled materials and by becoming cleaner and more efficient. For information on Vauxhall's efforts to achieve an environmentally sustainable future, see www.vauxhall.co.uk/recycling

Fleet Customer Services

Our dedicated support services for fleet managers includes factory demonstrators, a three-day test drive programme and information on whole life costs, company car taxation and finance. For further information please call **0870 010 0651**.

Buying your car

GMAC offers one of the most comprehensive and competitive ranges of financing plans in the UK. Contact your local Vauxhall retailer for details or call the GMAC customer service centre on **0845 712 3444**.



When you have finished with this brochure please recycle it

The GM Card is issued by HFC Bank Limited and is available to persons aged 18 years or over and resident in the UK (or 21 and over in the Channel Islands) and is subject to status and conditions. Written quotations are available upon request from The GM Card, PO Box 3615, Birmingham B3 2RJ. The typical APR quoted is the rate for new customers. Rebate Points are earned on purchases using The GM Card. Rebate Points are not earned on Balance Transfers or Cash Advances. You earn money off a new Vauxhall by accumulating Rebate Points under the Rebate Points Programme. General Motors UK Limited is solely responsible for the operation of the Rebate Points Programme, which is subject to the Rebate Points Programme Rules. *You can redeem up to 1500 Rebate Points subject to the Model Line Maximum which will vary in amount in relation to different Vauxhall vehicle model lines and unlimited Partner Points. Rebate Points and unlimited Partner Points are redeemable as discounts on a new Vauxhall vehicle and must be redeemed four years from the issue date. Rebate Points may not be redeemed by Motability Contract Hire customers. The GM Card is a trading name and style of both HFC Bank Limited and General Motors UK Limited. HFC Bank registered in England No. 1117305. Registered Office: North Street, Winkfield, Windsor Berkshire SL4 4TD is authorised and regulated by the Financial Services Authority. Member HSBC Group HFC Bank Limited is not a member of the same group of companies as General Motors UK Limited or GMAC UK plc. General Motors UK Limited, Registered Office: Griffin House, Osborne Road, Luton, Bedfordshire LU1 3YT. Registered in England number 135767. - CN6/0987.

Every effort has been made to ensure that the contents of this publication were accurate and up-to-date at the time of going to press (February 2010). Vauxhall vehicles are equipped with components manufactured by various General Motors operating units and outside suppliers. The Company reserves the right to alter specifications and withdraw products from sale without notice. Any such alterations will be notified to Vauxhall retailers at the earliest opportunity; please consult your local retailer for the latest information. The specifications detailed within this brochure are not necessarily applicable to alternative models such as Special Editions. Details of any such models will be contained in specific literature or found on the Vauxhall website. Please note that Vauxhall retailers are not the agents of General Motors UK Limited and are not authorised to bind the Company by any specific or implied undertaking or representation. It is advisable to ensure that your motor insurance policy provides adequate cover for additional fitted options and accessories. Please note accessories shown are for illustrative purposes only. As part of Vauxhall's policy of environmental care, this brochure is printed on paper manufactured using Elemental Chlorine Free pulps from specially farmed, sustainable timber resources. All rights reserved. No part of this publication may be reproduced in any form or by any means, without the prior written permission of General Motors UK Limited.

Vauxhall Extended Warranty

For complete peace of mind Vauxhall offers an extended warranty that can be purchased on an annual basis following the expiry of the original new car warranty. It covers most mechanical and electrical components. Terms and conditions apply, for further details please contact your local Vauxhall retailer.

Specialist Mobility advice

Motability accredited Vauxhall retailers can provide special mobility help and advice. Blue badge holders are entitled to very favourable discounts on new vehicles. Contact your local Motability accredited Vauxhall retailer or **Freefone 0800 731 5267**.

Servicing and maintenance

The best way to maximise the performance and reliability of your Vauxhall is to have all routine servicing and maintenance carried out at one of around 400 Vauxhall retailers. To find your nearest retailer call **0845 600 1500**.

In the event of an accident...

Vauxhall Accident Support helps keep you mobile following an accident. Benefits include scene-of-accident advice, message service, assistance with claims and vehicle recovery. For further details call **0800 010 304**.

Vauxhall Insurance

Available for new and used Vauxhalls, a Vauxhall Insurance policy offers a unique package designed specifically for Vauxhall drivers. For a highly competitive quotation, call **0844 84 85 840** (Great Britain) or **0845 35 13 410** (N. Ireland). Or just visit our website at www.vauxhall.co.uk

For more information...

For a brochure on any Vauxhall model (up to a maximum of three per caller) or location of your nearest Vauxhall retailer please **Lo-call 0845 600 1500**.

Alternatively, details can be found on our website at www.vauxhall.co.uk



- Save up to **£1500*** on a new Vauxhall with The GM Card
- **100 Rebate Points worth £100** when you use The GM Card for the first time
- Rebate Point saving is on top of any discount or offer negotiated with the Retailer
- Earn **3 Rebate Points (£3)** for every **£100** you spend

Typical 14.9% APR variable

To apply call **0845 746 2777** or visit www.gmcard.co.uk

