

## Trust Vauxhall

### Protecting the environment

Vauxhall's commitment to the environment is demonstrated by our products' many environmental awards, won both through the use of more recycled materials and by becoming cleaner and more efficient. For information on Vauxhall's efforts to achieve an environmentally sustainable future, see [www.vauxhall.co.uk/recycling](http://www.vauxhall.co.uk/recycling).

### Fleet Customer Services

Our dedicated support services for fleet managers includes factory demonstrators, a three-day test drive programme and information on whole life costs, company car taxation and finance. For further information please call **0870 010 0651**.

### Buying your car

GMAC offers one of the most comprehensive and competitive ranges of financing plans in the UK. Contact your local Vauxhall retailer for details or call the GMAC customer service centre on **0845 712 3444**.

### Sureguard protection

Sureguard Assistance offers the benefits of Vauxhall Assistance for three years from first registration, while Sureguard Warranty also provides a parts and labour warranty for high-mileage or long-term owners. For details contact your local Vauxhall retailer or call **0870 752 7020**.

### Specialist Mobility advice

Motability accredited Vauxhall retailers can provide special mobility help and advice. Blue badge holders are entitled to very favourable discounts on new vehicles. Contact your local Motability accredited Vauxhall retailer or **Freefone 0800 731 5267**.

### Servicing and maintenance

The best way to maximise the performance and reliability of your Vauxhall is to have all routine servicing and maintenance carried out at one of around 400 Vauxhall retailers. To find your nearest retailer call **0845 600 1500**.

### In the event of an accident...

Vauxhall Accident Support helps keep you mobile following an accident. Benefits include scene-of-accident advice, message service, assistance with claims and vehicle recovery. Call **0800 010 304** for a free driver's pack.

### Vauxhall Insurance

Available for new and used Vauxhalls, a Vauxhall Insurance policy offers a unique package designed specifically for Vauxhall drivers. For a highly competitive quotation, call **0870 024 0240** or visit our website at [www.vauxhall.co.uk](http://www.vauxhall.co.uk).

### For more information...

For a brochure on any Vauxhall model (up to a maximum of three per caller) or location of your nearest Vauxhall retailer please **Lo-call 0845 600 1500**.

Alternatively, details can be found on our website at [www.vauxhall.co.uk](http://www.vauxhall.co.uk)

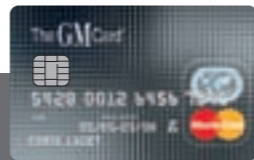

- Save up to £2000\* on a new Vauxhall with The GM Card

- 100 Rebate Points worth £100 when you use The GM Card for the first time

- Rebate Point saving is on top of any discount or offer negotiated with the Retailer
- Earn 3 Rebate Points (£3) for every £100 you spend

**Typical 14.9% APR variable**

To apply call **0845 746 2777** or visit [www.gmcard.co.uk](http://www.gmcard.co.uk).

For a copy of this brochure in large print, Braille or on audio tape, please call **0845 600 1500**, or via our textphone service on **18001 08456 785 785**.

The GM Platinum Card is issued by HFC Bank Limited and is available to persons aged 18 years or over and resident in the UK (or 21 and over in the Channel Islands) and is subject to status and conditions. Written quotations are available upon request from The GM Platinum Card, PO Box 3615, Birmingham B3 2RJ. The typical APR quoted is the rate for new customers. \*Rebate Points are earned on purchases using The GM Platinum Card. Rebate Points are not earned on Balance Transfers or Cash Advances. You earn money off a new Vauxhall/Saab by accumulating Rebate Points under the Rebate Points Programme. Vauxhall Motors Ltd is solely responsible for the operation of the Rebate Points Programme, which is subject to the Rebate Points Programme Rules. You can redeem up to 2500 Rebate Points subject to the Model Line Maximum which will vary in amount in relation to different Vauxhall/Saab vehicle model lines and unlimited Partner Points. Rebate Points and unlimited Partner Points are redeemable as discounts on a new Vauxhall/Saab vehicle and must be redeemed four years from the issue date. Rebate Points may not be redeemed by Motability Contract Hire customers. The GM Card is a trading name and style of both HFC Bank Limited and Vauxhall Motors Ltd. HFC Bank registered in England No. 1117305. Registered Office: North Street, Winkfield, Windsor, Berkshire SL4 4TD is authorised and regulated by the Financial Services Authority. Member HSBC Group. HFC Bank Limited is not a member of the same group of companies as Vauxhall Motors Ltd, Saab GB Limited or GMAC (UK) plc. Vauxhall Motors Ltd, Registered Office: Griffin House, Osborne Road, Luton, Bedfordshire LU1 3YT. Registered in England number 135767. - CN6/0987.

Every effort has been made to ensure that the contents of this publication were accurate and up-to-date at the time of going to press (January 2007). Vauxhall vehicles are equipped with components manufactured by various General Motors operating units and outside suppliers. The Company reserves the right to alter specifications and withdraw products from sale without notice. Any such alterations will be notified to Vauxhall retailers at the earliest opportunity; please consult your local retailer for the latest information. The specifications detailed within this brochure are not necessarily applicable to alternative models such as Special Editions. Details of any such models will be contained in specific literature or found on the Vauxhall website. Please note that Vauxhall retailers are not the agents of Vauxhall Motors Limited and are not authorised to bind the Company by any specific or implied undertaking or representation. It is advisable to ensure that your motor insurance policy provides adequate cover for additional fitted options and accessories. As part of Vauxhall's policy of environmental care, this brochure is printed on paper manufactured using Elemental Chlorine Free pulps from specially farmed, sustainable timber resources. All rights reserved. No part of this publication may be reproduced in any form or by any means, without the prior written permission of Vauxhall Motors Limited.

VM0606819 Published February 2007. Amended April 2007 (BMB/Graymatter) Vauxhall Motors Limited, Luton LU1 3YT

**Zafira 2007 Edition 2 (VM0606819)**

**Please note:** Zafira models no longer feature Adaptive Brake Lights (ABL) as standard equipment.

05/07

VM0707299



2007 Edition 2

# Zafira

A clever family car from Vauxhall





Zafira Design

# Zafira

## a clever family car from Vauxhall

The seven-seater people carrier with the winning formula. Sharp style, a smart interior and a dynamic driving experience – plus Vauxhall's unique Flex7 seating system. All cleverly combined into one brilliant package.

Zafira is yet another brilliant interpretation of the bold new Vauxhall design philosophy. If you're fed up with boxy looking MPVs, here's a compact people carrier that will redress the balance. IDS-plus chassis, direct injection petrol engines and high tech turbo diesels. Zafira is all about excitement, putting the driver first in a world dominated by the demands of space and versatility. And this is the clever bit. With Zafira you get all this style, all this dynamic driving experience, plus Vauxhall's legendary Flex7 seating system and an innovative panoramic roof option.

*This brochure covers Zafira Expression, Life, Club, Design and SRi models only. Some of the vehicles shown in this brochure include options and accessories available at extra cost. And not all of the features described are available on every model. So please check the Equipment section for further details. From time to time, we also offer alternative Zafira models such as Special Editions which are featured in separate literature or can be found on the website [www.vauxhall.co.uk](http://www.vauxhall.co.uk)*

Styling 4

Flex7 seating 6

Driving dynamics 14

Drivetrain 16

Safety and security 18

Driver equipment 20

Passenger equipment 22

Model line-up 24

Vauxhall by Design 32

Zafira VXR 38

Colours and trims 42

Equipment and technical data 46

# Family travel has never been so stylish.

Here's a welcome change. A seven-seater compact Multi-Purpose Vehicle (MPV) that looks great too. Zafira has distinctive front styling, cool 3D-style headlights, a radical tapered roofline and some great alloy wheel designs. It's altogether sharper and more dynamic than other MPVs, yet has a level of practicality that is unsurpassed. It's easy to get into and out of. It holds seven in comfort. It's devilishly easy to park. And the kids will always have plenty of space for those unexpected mates.





## More comfort wherever you sit

The Zafira design themes move effortlessly from outside to inside, with a driver-friendly fascia and high quality interior materials throughout. This is a car designed to make family travel easy. So it's light and spacious, comfortable and clever – wherever you're sitting.



## More versatility..

Whether it's you plus a business colleague or two grown-ups and half a playgroup, Zafira has all the answers thanks to Vauxhall's innovative Flex7 seating system. In literally seconds, you can transform the car from a two-seater, high capacity carry-all into a spacious, fully featured, seven-seater people carrier – and back – whenever you need.





**▼ Folding third row seats.** When you're not using Zafira's third row seats, they can be folded flush with the load floor. So there's no need to remove them completely to free up luggage space. In addition, both seats fold separately, so Zafira can carry six people plus a large item of luggage.



**◀ ▼ Practical stowage.** You can never have enough places to put your belongings, so Zafira comes with more than just a glovebox and door pockets. There are front sill storage bins, front passenger's underseat storage tray and footwell storage net. If we found a spare space, we put it to practical use.

**▲ FlexOrganiser.®** Now we're talking clever. Comprising four side rails with sliding side rail hooks, plus a specially devised 3D storage net and side net pocket, this optional FlexOrganiser® Pack, is the smartest, more versatile way to manage your Zafira load area.

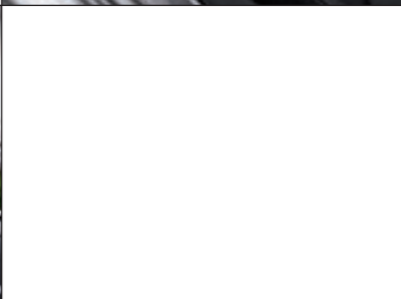

## ...more space for a quality lifestyle.

With up to 1820\* litres of available luggage space, Zafira has all the load capacity of a large estate car – with plenty more interior space for all your essential travelling kit. And it's all down to clever design – Flex7 seating, innovative storage ideas such as the front sill storage bins, and practical options and accessories such as the cargo liner and FlexOrganiser,® one of the most practical, sensible in-car storage systems ever.

\*Measured to roof with second and third row seats folded.





Life is better  
on the move.





▼ **ESP-plus.** Especially useful on wet roundabouts and greasy roads or whenever a slippery surface catches you out, Electronic Stability Programme (ESP-plus), senses if the car starts to slide on a bend and applies corrective braking to the appropriate wheels to help you regain control.

▲ **Sport switch.** Think of it as sports performance to suit your mood. Hit the Sport switch and you get a sharper throttle and more responsive steering. Models with optional IDS-plus also add sportier chassis dynamics with more body control. It also controls the automatic transmission's Sport mode.



**Interactive Driving System (IDS-Plus).** This very clever optional system incorporates electronic damping, which senses changes in the vehicle dynamics and automatically adjusts the damper rates – in real time. The result is confident cornering behaviour and sharper handling with reduced body roll. Pretty smart for a sports car, let alone a seven-seater compact MPV.

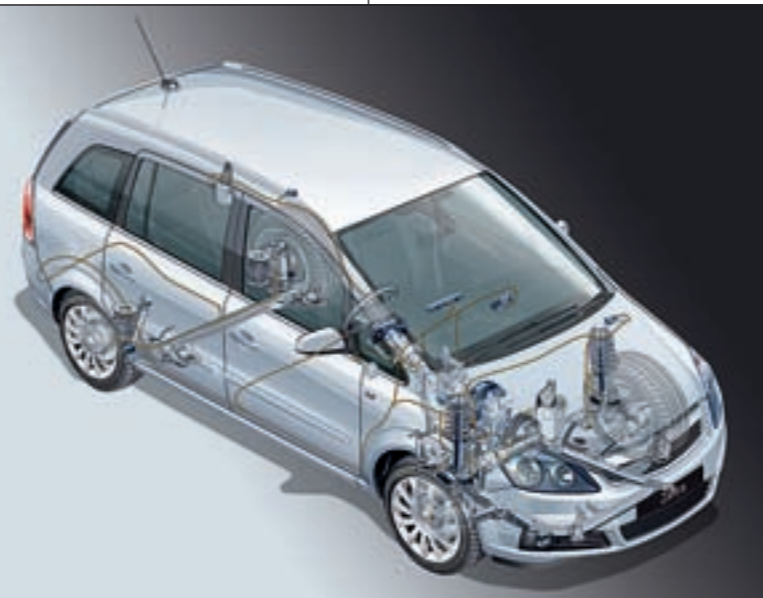

◀ **Hill Start Assist (HSA).** Available as part of the optional Towing Pack, HSA stops your car rolling back on a gradient (5% or steeper) when you take your foot off the brake. It does this by maintaining brake pressure for 1.5 seconds after the pedal has been released or until the accelerator is applied.



## You're in control ...

Here's another dilemma solved. Choose Zafira and there's no need to compromise driver enjoyment for effortless MPV versatility. The dynamic Zafira chassis combines precise, secure roadholding with built-in technological innovation. Out on the road, you'll certainly notice the reassuring sense of control it gives you. And how much more relaxed and secure you feel about driving under any conditions.



## MPV performance has never been so dynamic.

Think Vauxhall. Think advanced engine technology. All of Zafira's engines – four petrol and two high performance common rail turbo diesels – are brilliantly efficient, multi-valve units designed to produce an impressive spread of power – as flexible and responsive as they are economical.



◀ **Petrol engines.** Zafira's twin-cam 1.6i 16v features multi-point sequential fuel injection and Twinport intake technology for excellent power delivery, fuel economy and low emissions. The 2.0i 16v Turbo makes Zafira one of the only compact MPVs with 200PS on tap. And the all-aluminium, 150PS 2.2i 16v Direct uses direct petrol injection for outstanding fuel economy, flexibility and refinement. The 140PS 1.8i 16v VVT engine uses Double Continuous Variable Cam Phasing (DCVCP), to provide most of the available torque across a wide rev band. The result? More power and lower fuel consumption.



▲ **Six-speed.** Zafira comes with a six-speed manual gearbox as standard on all 2.2i 16v, 2.0i 16v Turbo and 1.9CDTi (120PS and 150PS) engines. Others come with a five-speed manual as standard, with four- and six-speed automatic and five-speed Easytronic transmission options also available at extra cost.

▼ **CDTi diesels.** That's 'CD' for common rail diesel technology, 'T' for turbocharged and 'i' for fuel injected. Put them all together and you've got the most up-to-date diesel technology around. Both Zafira engines are CDTi, providing serious diesel performance and economy, tough emissions control and low benefit in kind company car tax. Choose from two 1.9CDTi diesels – one rated at 120PS, the other at 150PS.



▲ **Easytronic transmission.** Choose the optional Easytronic transmission and you'll get a five-speed manual gearbox with a fully automatic mode. In manual mode, you simply push the lever forward or back to shift gears up or down. The fascia display tells you what gear you're in – 1 to 5, N for Neutral or A for Auto. Switch to fully automatic mode and it has many of the features of a regular automatic including a kickdown function. There's no clutch pedal so you can drive it on an automatic-only driving licence.



◀▶ **Six airbags.** Zafira protects you and your family with up to six full-size airbags, specially developed to provide maximum protection. Every model has front airbags and enlarged 'thorax-pelvis' front seat side-impact airbags. Most have full-size curtain airbags, too.



▶ **Adaptive Forward Lighting (AFL).** This important safety technology not only features the latest in bi-xenon headlight technology but the headlight beam itself moves up to 15 degrees in the same direction as the steering wheel, to light up where you're heading. AFL also raises the dipped headlight beam when you reach 65mph to extend the range of vision for increased safety and automatically returns the beam to its normal setting when you slow down. In addition this option package also offers high-pressure headlight washers and dynamic headlight levelling.



**Adaptive Brake Lights.** ABS brakes can shorten your stopping distance in slippery road conditions, but what about the driver behind you? With Zafira, if the ABS is activated the brake lights blink at four times a second, warning the following driver that you're emergency braking.



**Anti-lock braking system (ABS).** On its own, it's a huge benefit in emergency braking, but Zafira goes even further. Emergency Brake Assist (EBA), Electronic Brakeforce Distribution (EBD) and Cornering Brake Control (CBC) make the car easier to control and stop in extreme cornering and braking situations.

▲ **Remote control alarm system.** Ultrasonic security alarm system features forced entry detection, along with tilt, movement and rear glass breakage sensors, plus a power siren complete with its own power supply.



## Intelligent reassuring safety and security.

Zafira has a strong reputation for safety and security, and with good reason. The chassis is packed with active safety innovations that help you avoid accidents in the first place. And passive safety features include up to six full-size airbags, a pyrotechnic front bodylock seatbelt pretensioner system and full three-point seatbelts for all seven seats. Important security features include an engine immobiliser, remote control central deadlocking and an optional remote control ultrasonic alarm system.

▼ **Cruise control.** The easy-to-use, tap-up/tap-down cruise control is now available on most Zafira models. It allows you to maintain a steady speed without keeping your foot on the throttle. So it's more comfortable on long journeys and easier to keep to speed limits too.



▶ **Sensing features.** Choose Zafira Design and your driver environment is packed with clever ideas, all aimed at keeping your attention on the road ahead. Activate the rain-sensitive wipers and they'll switch themselves on automatically when it rains. Automatic lighting control does the same for the headlights when it starts to get dark. And the electro-chromatic rear-view mirror automatically reduces glare from the headlights of the car behind.



▶ **Satellite Navigation.** You'll never get lost or stuck in traffic with optional satellite navigation. It can determine your precise location and guide you to your destination by the best and fastest route. The Traffic Message Channel (TMC) function can even change the route according to breaking traffic news.



▼ **Mobile phone system with Bluetooth.\*** With the optional mobile phone system, your phone interfaces with the audio unit, for operation via the steering wheel controls and facia display. Bluetooth® wireless connectivity with voice activation is included. See page 53 for more detailed information.

\*Please refer to the Car and Accessory Price Guide for a list of phone-specific cradles.

**Multi-function trip computer.** Standard on Zafira Design and SRi, this invaluable driver information system provides instantaneous and average fuel consumption, fuel consumed, average speed, distance travelled and range based on fuel remaining.

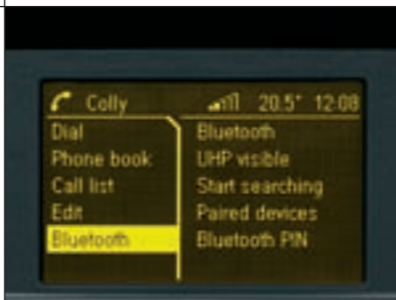

## A dynamic driving environment

Zafira's driver environment is packed with clever ideas. You sit high up, with a good view of the road ahead. The driver's seat has height adjustment and the steering column adjusts for reach and rake as standard, so it's easy to find the perfect driving position. To make driving easy, the switchgear is ergonomically placed, and there's a high-mounted gear lever for more comfortable shifting.



## Keeping everybody happy

With Zafira, it's not only about accommodating more passengers as the need arises, it's about making those in the rear seats just as welcome as those in the front. Wherever you're sitting you'll be amazed just how much Zafira has to offer. And we don't just mean that great feeling of light and space, but practical considerations like air-conditioning, rear seat audio and plenty of places to store all those travel essentials like drinks, books or sunglasses.



**Air-conditioning.** It makes for a fresher interior atmosphere all year round, with chilled air on hot days and faster demisting when it's damp. Move up to optional Electronic Climate Control (ECC) and you can maintain the interior temperature to within a single degree.

**Twin Audio.** With Zafira's optional independent rear seat Twin Audio system, the front and two second-row rear passengers can listen to the radio or a compact disc totally independently and at the same time. It comes with separate second-row rear seat audio controls – an on/off switch, independent volume controls for each headset, switching between CD and radio tuner and a scan function. And it even mutes the rear speakers when the headphones are in use. While a single earplug headphone set is included, additional accessory headphone sets and alternative earhook headphones are also available.

**Quality sounds.** Every Zafira features a quality stereo radio/CD player, with steering wheel mounted audio controls on Club, Design and SRi models. Optional systems add MP3 CD compatibility, user-friendly satellite navigation with colour display, and our innovative Twin Audio system.



**Panoramic roof.** Talk about a personalised travel environment! The optional Zafira panoramic roof combines four separate glass roof panels – each with a power-operated sunblind to help reduce glare – with a five-compartment, central overhead console. So there's always somewhere to put your mobile phone, personal music player, sunglasses... or hand held games console.



# You decide

which Zafira is right for you.

No two families are the same. Likewise Zafira. With six feature-packed trim levels – plus the awesome Zafira VXR – and a further choice of engines, transmissions, colour and trim, there are models to suit every taste and every pocket. Choose Expression or Life for flexible and affordable family transport. Club features a little more style, a touch more practicality and valuable safety enhancements. Design has a real contemporary slant – upmarket features and serious performance. And SRI models are the sporting driver's choice with the Exterior Pack version featuring 18-inch alloy wheels and the VXR Styling Pack One. Proof indeed that MPV ownership can still provide bags of driving excitement. Add a huge range of options, option packs and accessories and it's easy to turn our Zafira into your Zafira.

**EXPRESSION AND LIFE**

**Standard features include:**

- Anti-lock braking system
- Power-assisted steering
- Twin front airbags
- Front seat side-impact airbags
- Driver's seat height adjuster
- Electric door mirrors
- Electric front windows
- Remote control central deadlocking
- Steering wheel adjustable for reach and rake
- Air-conditioning (Life\*)
- Stereo radio/CD player
- 12-volt auxiliary power socket located in luggage compartment
- Black roof rails (Life)

**Engine availability and insurance groups (ABI)**

Expression	
1.6i 16v	5E
Life	
1.6i 16v	5E
1.8i 16v VVT	8E
1.8i 16v VVT Easytronic	8E
2.2i 16v Direct	9E
2.2i 16v Direct Automatic	9E
1.9CDTi (120PS)	7E
1.9CDTi (120PS) Automatic	7E

*\*Non air-conditioned 1.6i 16v model also available. Model illustrated features Flame Red solid paint. Life model interior illustrated.*



**CLUB**

**Standard features include:**

- Anti-lock braking system
- Twin front airbags
- Front seat side-impact airbags
- Driver's seat height adjuster
- Electric front windows
- Remote control central deadlocking
- Steering wheel adjustable for reach and rake
- Air-conditioning\*

**Additional features over and above Life model include:**

- 16-inch Structure wheels
- Front passenger's seat undertray
- Steering wheel mounted audio controls
- Electrically adjustable/heated door mirrors
- Full-size curtain airbags
- Body-colour bumper inserts, door handles and side-protection mouldings

**Engine availability and insurance groups (ABI)**

1.6i 16v	5E
1.8i 16v VVT	8E
1.8i 16v VVT Easytronic	8E
2.2i 16v Direct	9E
2.2i 16v Direct Automatic	9E
1.9CDTi (120PS)	7E
1.9CDTi (120PS) Automatic	7E

*\*Non air-conditioned 1.6i 16v model also available. Model illustrated features Peacock two-coat pearlescent paint, optional at extra cost.*



**DESIGN****Standard features include:**

- Anti-lock braking system
- Twin front airbags
- Front seat side-impact airbags
- Full-size curtain airbags
- Electric front windows
- Remote control central deadlocking
- Steering wheel adjustable for reach and rake
- Air-conditioning

**Additional features over and above Club model include:**

- 16-inch alloy wheels
- Dark-tinted rear glass
- Front fog lights
- Multi-function trip computer
- Electric rear windows
- Driver's armrest
- Driver's seat with tilt and lumbar adjustment
- Rain-sensitive windscreen wipers
- Leather-covered three-spoke steering wheel
- Silver roof rails

- ▶ CD 70 stereo radio/CD/MP3 CD player with satellite navigation and colour monitor, optional at extra cost



- ◀ 17-inch, ten-spoke alloy wheels with 225/45 R 17 ultra-low profile tyres

**Engine availability and insurance groups (ABI)**

1.8i 16v VVT	8E
1.8i 16v VVT Easytronic	8E
2.2i 16v Direct	9E
2.2i 16v Direct Automatic	9E
2.0i 16v Turbo	13E
1.9CDTi (120PS)	9E
1.9CDTi (120PS) Automatic	9E
1.9CDTi 16v (150PS)	9E
1.9CDTi 16v (150PS) Automatic	9E

*Model illustrated features Panoramic Roof Pack, and Silver Lightning two-coat metallic paint, all optional at extra cost.*

**Additional features on 2.2i 16v Direct, 2.0i 16v Turbo and 1.9CDTi (150PS) models:**

- 17-inch ten-spoke alloy wheels with 225/45 R 17 ultra-low profile tyres
- Electronic Stability Programme-plus (ESP-plus) with traction control
- Sports suspension
- Sport switch





**SRI****Standard features include:**

- Anti-lock braking system
- Twin front airbags
- Front seat side-impact airbags
- Full-size curtain airbags
- Electric front windows
- Remote control central deadlocking
- Steering wheel adjustable for reach and rake
- Air-conditioning

**Additional features over and above Club model include:**

- 17-inch alloy wheels
- Remote control ultrasonic security alarm
- Electronic Stability Programme (ESP-plus) with traction control
- Sports suspension
- Sport switch
- Aluminium pedals
- Dark-tinted rear glass
- Electric rear windows
- Matt chrome-effect centre console
- Front fog lights
- Multi-function trip computer
- Sports front seats with driver's armrest
- Driver's seat with tilt and lumbar adjustment
- Leather-covered three-spoke sports steering wheel
- Rear roof spoiler
- Sunglasses holder
- Silver roof rails
- Chrome exhaust tailpipe (2.0i 16v Turbo models only)

- ▶ CD 70 stereo radio/CD/MP3 CD player with satellite navigation and colour monitor, optional at extra cost



- ◀ 18-inch, 5-spoke alloy wheels with 225/40 R 18 ultra-low profile tyres

**Additional features for SRI models with Exterior Pack:**

- 18-inch alloy wheels
- VXR Styling Pack One

**Engine availability and insurance groups (ABI)**

1.8i 16v VVT	8E
2.2i 16v Direct	9E
2.2i 16v Direct Automatic	9E
2.0i 16v Turbo	13E
1.9CDTi (120PS)	9E
1.9CDTi (120PS) Automatic	9E
1.9CDTi 16v (150PS)	9E
1.9CDTi 16v (150PS) Automatic	9E

*Model illustrated features Panacotta two-coat pearlescent paint, optional at extra cost. (Zafira SRI 2.0i 16v Turbo model illustrated.)*

*Please note: Chrome exhaust tailpipe illustrated is standard on 2.0i 16v Turbo models only.*



## Vauxhall by Design

Vauxhall by Design is all about choice – selecting your new car, then personalising it to suit yourself with our choice of individual options, special option packs and accessories – all available at highly attractive prices. You'll find more information on the following pages. Or ask your Vauxhall retailer for further details.



Inspired by our hugely successful VXRRacing team, VXR styling products come with all the same experience, knowledge and passion for style and performance. They put the accent firmly on quality and exclusivity, with a winning edge. And they add flair, personality and excitement to every Zafira model. VXR styling products are available as factory-fit option packs or accessories fitted by your Vauxhall retailer. Please refer to the Vauxhall Car and Accessory Price Guide for availability details of the full Vauxhall VXR range.

**VXR Styling Pack One.** Breathe some extra style into your Zafira with a front lower spoiler, side sills, rear roof spoiler\* (below) and rear lower skirt. All of these items are also available separately.

*\*Standard on SRI.*



**Irmscher styling.** For a style update, treat your Zafira. Model illustrated features a front lower spoiler, cross hatch grille with aluminium upper and laser-etched 'Irmscher' badge, side sills, and 18-inch Stila wheels.



**Irmscher sports silencers.** For distinctive looks (with chrome-plated tailpipes) and a sportier exhaust note, these split oval design tailpipes are the perfect choice for your Zafira.



Developed in conjunction with auto design specialists Irmscher International, Zafira styling accessories perfectly complement the vehicle's lines, as well as being manufactured to the same exacting standards as the car itself. For availability details please refer to the Vauxhall Car and Accessory Price Guide.

*Irmscher*

**Irmscher alloy wheels.** They're the perfect way to personalise your Zafira. With a huge range to choose from (style illustrated is Evo Star), and sizes from 16 to 19 inches, you're sure to find one to suit your style and budget. And don't forget to ask about our accessory wheel locking kits too.

Zafira options can enhance your ownership experience in so many ways. Alloy wheels, satellite navigation, FlexOrganiser,<sup>®</sup> leather trim – there's a huge range to choose from and they're available individually or in special option packs at great prices. You'll find further information on availability in the Equipment section. Or you can ask your Vauxhall retailer.



 **Panoramic Roof Pack.**

- Four glass roof panels
- Roof mounted storage console for front and rear passengers
- Alloy-effect roof rails
- Heat-reflective windscreen

**Towing Pack.**

- Detachable tow bar\*
- Trailer stability programme
- Hill Start Assist\*\* (HSA)
- Tyre deflation detection system\*\*
- Cruise control

\*Requires adaptor for UK electrics.  
\*\*Not available with automatic transmission.

 **FlexOrganiser<sup>®</sup> Pack.**

- 3D storage net
- Side net pocket
- Four side rail hooks
- Four side rails

**Seat Comfort Pack 1.**

- Driver's seat tilt and lumbar adjustment

**Seat Comfort Pack 2.†**

- Front passenger's seat height, tilt and lumbar adjustment

**Leather Pack.†**

- Leather seat facings
- Electrically heated sports front seats with tilt and lumbar adjustment
- Front passenger's seat height adjuster

†Deletes underseat storage tray.



**Front and rear parking distance sensors.** This clever early warning system helps safeguard your car and pedestrians. When activated, the system beeps as you approach an obstruction rising to a continuous tone when the object is approximately 300mm away.



 **Remote control security alarm.**

Standard on Zafira SRi and optional on most other models, this advanced ultrasonic system monitors against intrusion to the interior, doors, tailgate and bonnet. It works even if the car's battery is flat or the wires are cut, and can be armed and disarmed via the car's remote control deadlocking key.

 **Curtain airbags.** Activating in the event of a side impact, full-size curtain airbags for the front and second-row seat passengers have long been standard on Zafira Club, Design and SRi models. Now this valuable safety enhancement is also available, at extra cost, on Expression and Life models.



**Individual options include:**

- Adaptive Forward Lighting
- Five-speed Easytronic transmission
- Interactive Driving System (IDS) with Continuous Damping Control (CDC)
- Electronic Stability Programme-plus (ESP-plus)
- Mobile phone system with Bluetooth<sup>®</sup>
- Twin Audio<sup>®</sup>

 **Automatic transmission.** The electronically-controlled, six-speed automatic has an adaptive driving function and a Winter mode, which selects third gear for standing starts in slippery conditions. It's available on both 1.9CDTi diesels. A four-speed automatic is available on 2.2i 16v Direct models.



 **Keyless entry and start.** Keyless entry and start system means that the driver need never remove their key fob from their pocket. When approaching the car, sensors in the front door handles and rear bumper detect the driver's proximity and automatically unlock the doors or boot when the handle is pulled.

When in the car, two internal sensors activate the ignition and release the electronic steering lock, enabling the driver to start or stop the engine merely by pressing the facia-mounted Start/Stop button. Upon leaving the vehicle, the driver can lock it by either pressing a button on the key fob like a conventional system, or by simply touching one of the sensors on the external handles of the front doors. The system also offers excellent theft protection by its use of sophisticated cryptographic algorithms.



Vauxhall accessories are the right choice for your Zafira. Whatever you're into, there's certain to be a Vauxhall accessory with your name on it. Available individually or in special packs, we've only featured a small selection here. The Vauxhall Car Accessory Brochure and Car and Accessory Price Guide give further details. Or check out our website at [www.vauxhall-accessories.com](http://www.vauxhall-accessories.com)



◀ **Protection Pack.**

- Velour mats
- Mudflaps
- Cargo liner



▼ **Travel Pack.**

- First aid kit
- Warning triangle
- Spare bulb kit (not for AFL headlights)
- Fire extinguisher
- Hi-visibility vest

▲ **Protection Plus Pack.**

- Paint and trim protection
- Velour mats
- Mudflaps



◀ **Side-loading bicycle carrier.** The perfect solution for easy loading and unloading, this innovative carrier has a swinging support bar which ensures the bike clears the side and roof of the car. A gas-assisted strut helps take the weight of the bike. Two carriers can be fitted to one base carrier.



◀ **Tow bar.** Both fixed (shown) and detachable tow bars are available, with 12N electrics, or 12N/12S twin electrics which also provide supplementary power for use in the caravan or trailer. Fitted by your Vauxhall retailer, all Vauxhall tow bars conform to top European regulations and standards.

▶ **Base carrier.** The Vauxhall roof rack system begins with a base carrier. It comprises two T-track bars which support a wide range of attachments including bicycle carriers and a choice of high-capacity roof boxes (available separately). Each carrier is supplied with locks for security.



▶ **Roof-mounted removable DVD player.** This 7-inch screen with wireless headphones and remote control provides the perfect rear seat passenger travel entertainment. It clicks into the roof docking station and can be easily removed for outdoor (with battery) or home (connected to TV) operation.

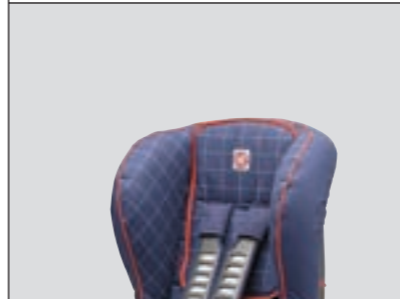

◀ **Child seats.** Vauxhall offers a range of child seats, ergonomically styled for comfort and safety. The Baby-Safe (for babies from birth to 13kg), and Kid (15-36kgs) seats are fixed with a standard lap and diagonal seatbelt, while the Duo ISOFIX (9-18kg) can also be attached using the ISOFIX child seat restraint fittings, which are standard on the outer middle row seats of all Zafira models. The rigid ISOFIX anchoring mechanism virtually eliminates the dangers of incorrect child seat installation.



◀ **Dog guard with space divider grid.\*** Designed to fit Zafira models, the heavy-duty steel dog guard helps keep your pet secure and protects passengers in the event of sudden braking. The space divider grid (sold separately) allows luggage to be stored on one side, and the dog to travel on the other.

\*The space divider grid can only be used in conjunction with the dog guard.  
N.B. Dog guard requires fitting kit (retailer-fit only).

# ZAFIRA VXR

This is extra-sensory stimulation. Cars with soul and power to make you feel alive, electrified and inspired. A range of driver-focused, performance machines for the road, born on the track.



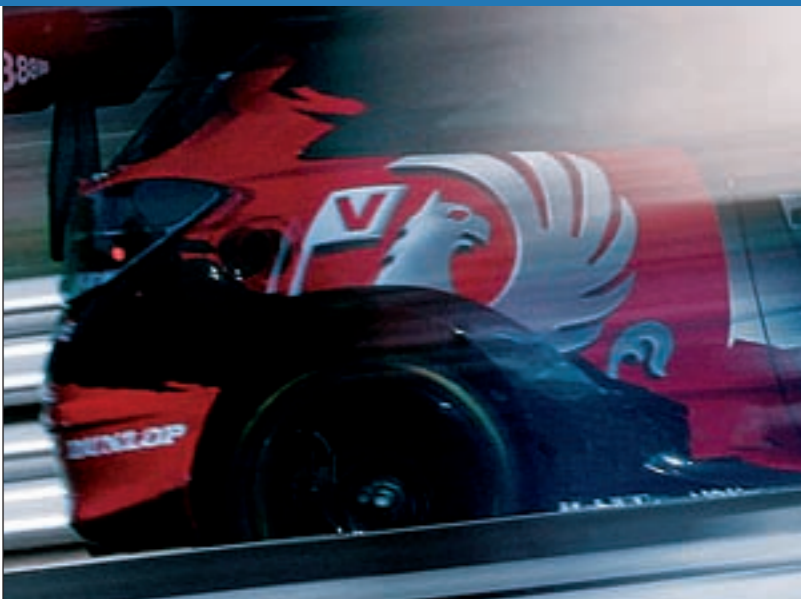

- > Unique VXR body styling
- > 240PS 2.0i 16v Turbo
- > 18-inch alloy wheels
- > Dual branch trapezoidal exhaust tailpipes



DISCOVER 7.2<sup>SEC</sup>  
0-60<sup>MPH</sup>

VXR takes the experience, knowledge and passion gained from racing and crystallises it into a range of performance road cars.



*For more information on the Zafira VXR please ask your Vauxhall retailer for a copy of the latest VXR range brochure.*



## ZAFIRA VXR.

Having a family didn't stop you having a life. You still ride, play, ski or whatever it is that sets you free. And you still want to drive, not just travel. What you need is a seven-seat performance car. Cue Zafira VXR. Same compact MPV format. But a whole new shape. And a whole new attitude. No other MPV looks this good. Enough said?

▶ Royal Blue – solid



▶ Flame Red – solid



▶ Star Silver – metallic



▶ Moonland – metallic



▶ Silver Lightning – metallic



▶ Metro Blue – metallic



▶ Panacotta – pearlescent



▶ Black Sapphire – pearlescent



Zafira comes in 11 different exterior colours. And each one suits the car beautifully. Every trim combination – cloth or soft leather – has been carefully selected to complement whatever colour you choose.

*Due to the limitations of the printing process the colours reproduced may vary slightly from the actual paint colour or trim material. As a result they should be used as a guide only. Your Vauxhall retailer has a comprehensive display of all our paint samples and trim swatches.*

▶ Steel Blue – pearlescent

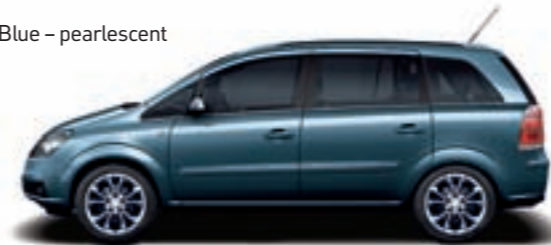

▶ Ultra Blue – pearlescent



▶ Peacock – pearlescent



▼ Alpha cloth



▼ Tabita cloth



▼ Silver Alpha cloth

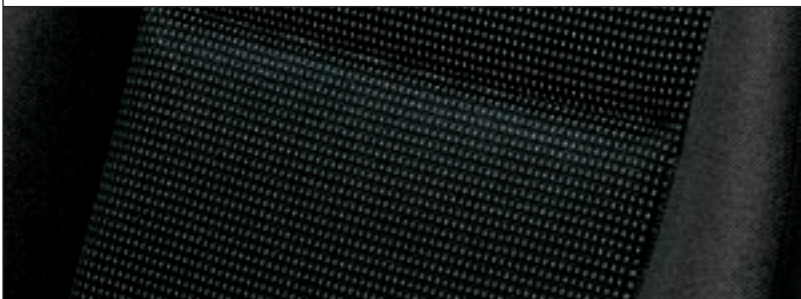

▼ Silver Alpha cloth/Morrocana

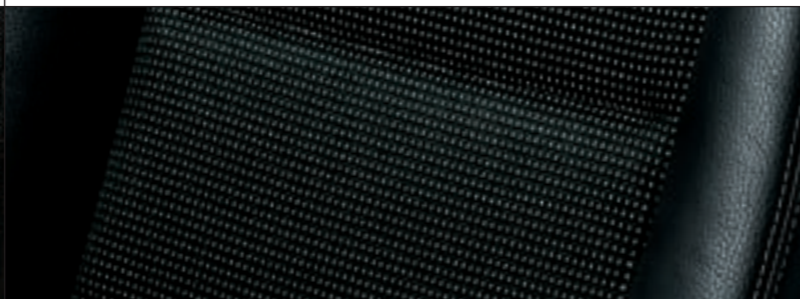

Exterior colours

Model, trim name and trim colour

	Expression/Life Alpha cloth	Club Tabita cloth	Design Silver Alpha cloth/Morrocana trim	SRI Silver Alpha cloth	Design/SRI Leather*
<b>Solid</b>					
Royal Blue	Charcoal	Charcoal	Charcoal	Charcoal	Charcoal
Flame Red	Charcoal	Charcoal	Charcoal	Charcoal	Charcoal
<b>Two-coat metallic*</b>					
Star Silver	Charcoal	Charcoal	Charcoal	Charcoal	Charcoal
Silver Lightning	Charcoal	Charcoal	Charcoal	Charcoal	Charcoal
Moonland	Charcoal	Charcoal	Charcoal	Charcoal	Charcoal
Metro Blue	Charcoal	Charcoal	Charcoal	Charcoal	Charcoal
<b>Two-coat pearlescent*</b>					
Peacock	Charcoal	Charcoal	Charcoal	Charcoal	Charcoal
Panacotta	Charcoal	Charcoal	Charcoal	Charcoal	Charcoal
Ultra Blue	Charcoal	Charcoal	Charcoal	Charcoal	Charcoal
Black Sapphire	Charcoal	Charcoal	Charcoal	Charcoal	Charcoal
Steel Blue	Charcoal	Charcoal	Charcoal	Charcoal	Charcoal

\* = Optional at extra cost.

▼ Leather





## SRi with Exterior Pack

Zafira SRi with Exterior Pack models feature the VXR Styling Pack One and 18-inch five-spoke alloy wheels with 225/40 R 18 ultra-low profile tyres as standard.



Electronic Stability Programme-plus.

## Safety

**Standard features** • Driver's and front passenger's airbags • Front seat side-impact airbags • Pedal release system – Reduces potential injury to the driver's legs and feet during a severe frontal impact • Laminated windscreen • Side-impact protection beams • Energy-absorbing steering column

• Child-proof locks on rear doors • ISOFIX child seat restraint system for outer second-row seats (does not include child seat) – Secures ISOFIX child safety seats to the vehicle itself, virtually eliminating the dangers that can result from improper installation

• Anti-lock Braking System (ABS) • Electronic Brakeforce Distribution (EBD) • Cornering Brake Control (CBC) – see **D1** on page 61 • Emergency Brake Assist (EBA) – see **D2** on page 61 • Adaptive Brake Lights (ABL) – If the driver brakes hard enough to activate the ABS the brake lights flash on and off at the rate of four times per second, thus warning following vehicles that heavy braking is in progress

• Pyrotechnic front body-lock seatbelt pretensioner system – Tightens the seatbelt during the early stages of a frontal impact • Front seatbelt force limiters – Reduce the loading on the occupants' chests by releasing the belts very slightly, if the force exceeds a specified limit, in a frontal impact • Height-adjustable head restraints on all seats • Inertia-reel lap and diagonal seatbelts on all seats

Additional features	Exp.	Life	Club	Design	SRi
Electronic Stability Programme-plus (ESP-plus) with traction control – see <b>D3</b> on page 61	○	○ <sup>1</sup>	○ <sup>1</sup>	○ <sup>2</sup>	●
Full-size curtain airbags (front and second-row seating)	○	○	●	●	●
Tyre deflation detection system – see <b>D4</b> on page 61			□	□	
Hill Start Assist (HSA) – see <b>D5</b> on page 62			□	□	

## Security

**Standard features** • Remote control central deadlocking (doors, tailgate and fuel flap) • 'Key left in ignition' audible warning • Electronic engine deadlock immobiliser • Locking wheel bolts for alloy wheels (where fitted) • Electronic theft protection for audio equipment

Additional features	Exp.	Life	Club	Design	SRi
Folding key			●	●	●
Keyless entry and start ignition system – see <b>D6</b> on page 62			○ <sup>3</sup>	○ <sup>3</sup>	○ <sup>3</sup>
Remote control ultrasonic security alarm system		○ <sup>4</sup>	○	○	●

## Seating and upholstery

**Standard features** • Flex7<sup>®</sup> seating system • Reclining front seats • Driver's seat height adjuster • 40/20/40 split-folding second-row seat back • Second-row seats with sliding function plus fold and stow facility • Multi-function fold-down second-row centre seat • Two individual fold-flat third-row seats • Carpeted passenger compartment, load area floor and rear seat backs

Additional features	Exp.	Life	Club	Design	SRi
Sports front seats				□	●
Leather seat facings				□	□
Driver's seat with tilt and lumbar adjustment			□	●	●
Front passenger's seat with tilt and lumbar adjustment			□	□	□
Driver's armrest				●	●
Heated front seats				□	□

## Facia, instruments and controls

**Standard features** • Steering column adjustable for reach and rake • Rev counter • Electronic odometer and trip odometer • Digital clock with automatic RDS time adjustment • Service-due indicator • Multi-function display panel showing time, date, audio information and outside air temperature (with ice warning function) • Electrical accessory socket

Additional features	Exp.	Life	Club	Design	SRi
Multi-function trip computer				●	●
Black instrument dials	●	●	●	●	
Black instrument dials with chrome edging					●
Three-spoke steering wheel	●	●	●		
Leather-covered three-spoke steering wheel				●	
Leather-covered three-spoke sports steering wheel					●
Cruise control			○	○	○



Driver's armrest.



Front centre console drinks holder.

● = Standard equipment.  
○ = Optional at extra cost.  
□ = Only available as part of an extra-cost option pack (see page 50 for details).  
Exp. = Expression.

1 = Standard on 2.2i 16v Direct model.

2 = Standard on 2.2i 16v Direct/2.0i 16v Turbo/1.9CDTi 16v (150PS) models only.

3 = Front passenger's underseat storage tray is deleted when Leather Pack, Seat Comfort Pack 2 or keyless entry and start options are specified.

4 = Includes map reading light, sunvisors with illuminated vanity mirrors and rear reading lights.



Aluminium pedals.



Sport switch.



17-inch ten-spoke alloy wheels.

## Interior features

**Standard features** • Air blend heater with four-speed fan and illuminated controls • Interior pollen filter • Air recirculation system with activation light • Second-row passenger compartment heating outlets • Drinks holder in centre console • Front and rear door pockets with drinks holders • Front sill storage bins • Drinks holders in third-row seat side armrests • Latched storage lockers in luggage compartment • 12-volt auxiliary power socket located in luggage compartment • Retractable luggage compartment cover

<b>Additional features</b>	Exp.	Life	Club	Design	SRi
Air-conditioning		● <sup>5</sup>	● <sup>5</sup>	●	●
Electronic Climate Control (ECC) with air quality sensor and graphic information display			○	○	○
Charcoal metallic-effect inserts on fascia and doors	●	●			
Microtech Silver inserts on fascia and doors			●	●	
Matt chrome-effect centre console insert					●
Maze chrome-effect inserts on fascia and doors					●
Aluminium pedals					●
Brushed aluminium door sill covers				●	●
Electro-chromatic anti-dazzle rear-view mirror				●	
Driver's sunglasses holder				●	●
Front passenger's underseat storage tray <sup>3</sup>			●	●	●

## Wheels and tyres

<b>Features</b>	Exp.	Life	Club	Design	SRi
16-inch steel wheels with flush covers and 205/55 R 16 ultra-low profile tyres	●	●			
16-inch Structure wheels with 205/55 R 16 ultra-low profile tyres			●		
16-inch five twin-spoke alloy wheels with 205/55 R 16 ultra-low profile tyres and locking bolts				● <sup>6</sup>	
17-inch ten-spoke alloy wheels with 225/45 R 17 ultra-low profile tyres and locking bolts			○ <sup>7</sup>	● <sup>8</sup>	
17-inch five-spoke alloy wheels with 225/45 R 17 ultra-low profile tyres and locking bolts					●
18-inch five-spoke alloy wheels with 225/40 R 18 ultra-low profile tyres and locking bolts					○ <sup>9,10</sup>
Steel spare wheel (includes second-row passenger compartment 12-volt electrical accessory socket)	○	○	○	○ <sup>11</sup>	○ <sup>11</sup>
Emergency tyre repair kit in lieu of spare wheel	●	●	●	●	●

## Mechanical

<b>Features</b>	Exp.	Life	Club	Design	SRi
Five-speed manual gearbox (1.6i 16v/1.8i 16v VVT)	●	●	●	●	●
Six-speed manual gearbox (2.2i 16v/2.0i 16v Turbo/1.9CDTi (120/150PS))		●	●	●	●
Five-speed Easytronic gearbox (1.8i 16v VVT)		○	○	○	
Four-speed automatic transmission (2.2i 16v)		○	○	○	○
Six-speed automatic transmission (1.9CDTi (120/150PS))		○	○	○	○
Sports suspension				● <sup>2</sup>	●
Sport switch – see <b>D7</b> on page 62				● <sup>2</sup>	●
Interactive Driving System-plus (IDS-plus) with Continuous Damping Control (CDC) – see <b>D8</b> on page 63					○

## Exterior features

**Standard features** • Green-tinted glass • Electrically operated front windows with safety autoreverse and one-touch facility • Intermittent rear window wash/wipe • Electrically adjustable door mirrors • Electric headlight beam levelling • H7 halogen headlights • Body-colour door mirrors

<b>Additional features</b>	Exp.	Life	Club	Design	SRi
Rain-sensitive windscreen wipers				●	
Automatic Lighting Control (ALC)				●	
Dark-tinted glass (excludes windscreen and front door windows)				●	●
Electrically operated rear windows with safety autoreverse and child isolation facility				●	●
Chrome exhaust tailpipe (2.0i 16v Turbo only)					●
Black roof rails		●	●		
Alloy-effect roof rails			□	●	●
Front fog lights				●	●
Two-coat metallic or pearlescent paint	○	○	○	○	○
Electrically heated door mirrors			●	●	●
Two-tone horn				●	●
Body-colour door handles and tailgate handle			●	●	●
Black side-protection mouldings	●	●			
Body-colour side-protection mouldings			●	●	●
Adaptive Forward Lighting (AFL) incorporating bi-xenon headlights with dynamic beam levelling and high-pressure headlight washers – see <b>D9</b> and <b>D10</b> on page 63			○ <sup>12</sup>	○	○
Front and rear parking distance sensors			○	○	○
Heat-reflective windscreen			□	□	□



18-inch five-spoke alloy wheels.

● = Standard equipment.  
○ = Optional at extra cost.  
□ = Only available as part of an extra-cost option pack (see page 50 for details).  
Exp. = Expression.

<sup>2</sup> = Standard on 2.2i 16v Direct/2.0i 16v Turbo/1.9CDTi 16v (150PS) models only.  
<sup>3</sup> = Front passenger's underseat storage tray is deleted when Leather Pack, Seat Comfort Pack 2 or keyless entry and start options are specified.  
<sup>5</sup> = Optional at extra cost on 1.6i 16v models.  
<sup>6</sup> = Standard on 1.8i 16v VVT/1.9CDTi (120PS) models.  
<sup>7</sup> = Only available in conjunction with ESP-plus.  
<sup>8</sup> = Standard on 2.2i 16v Direct/2.0i 16v Turbo/1.9CDTi 16v (150PS) models.  
<sup>9</sup> = Standard on SRi with Exterior Pack models. SRi with Exterior Pack models feature VXR Styling Pack One and 18-inch five-spoke alloy wheels with 225/40 R 18 ultra-low profile tyres. Please see the latest Vauxhall Car and Accessory Price Guide for availability details.  
<sup>10</sup> = Not available on 1.9CDTi 16v (150PS) automatic model with Panoramic Roof Pack.  
<sup>11</sup> = Not available on 2.0i 16v Turbo models or models fitted with optional 18-inch alloy wheels.  
<sup>12</sup> = AFL includes front fog lights on Club models.

● = Standard equipment.  
○ = Optional at extra cost.  
Exp. = Expression.

3 = Front passenger's underseat storage tray is deleted when Leather Pack Seat Comfort Pack 2 or keyless entry and start options are specified.  
7 = Only available in conjunction with ESP-plus.  
9 = Standard on SRi with Exterior Pack models. SRi with Exterior Pack models feature VXR Styling Pack One and 18-inch five-spoke alloy wheels with 225/40 R 18 ultra-low profile tyres. Please see the latest Vauxhall Car and Accessory Price Guide for availability details.  
13 = Not available on 1.9CDTi 16v (150PS) automatic SRi with Exterior Pack models or in conjunction with 18-inch alloy wheels on 1.9CDTi 16v (150PS) automatic SRi models.  
14 = Only available in conjunction with Electronic Stability Programme-plus. Requires 13-pin adaptor (available as a Vauxhall accessory). When Towing Pack is supplied in conjunction with automatic transmission the tyre deflation detection system and HSA are deleted.  
15 = Only available in conjunction with Seat Comfort Pack 1.

### Option packs

	Exp.	Life	Club	Design	SRi
<b>Leather Pack<sup>3</sup></b> ● Leather seat facings ● Electrically heated sports front seats with tilt and lumbar adjustment ● Front passenger's seat height adjuster				○	○
<b>Panoramic Roof Pack<sup>13</sup></b> ● Four glass roof panels ● Roof-mounted storage console for front and rear passengers ● Alloy-effect roof rails ● Heat-reflective windscreen			○ <sup>7</sup>	○ <sup>7</sup>	○
<b>Towing Pack<sup>14</sup></b> ● Trailer stability programme ● Hill Start Assist (HSA) ● Tyre deflation detection system ● Cruise control ● Detachable tow bar			○	○	
<b>Seat Comfort Pack 1</b> ● Driver's seat with tilt and lumbar adjustment			○	●	●
<b>Seat Comfort Pack 2</b> ● Front passenger's seat with tilt, height and lumbar adjustment			○ <sup>3,15</sup>	○ <sup>3</sup>	○ <sup>3</sup>
<b>VXR Styling Pack One</b> ● Body-colour lower front spoiler/rear lower skirt/rear roof spoiler and side sills			○	○	○ <sup>9</sup>
<b>FlexOrganiser<sup>®</sup> Pack</b> ● 3D storage net ● Side net pocket ● Four side rail hooks ● Four side rails			○	○	○

**Leather Pack<sup>3</sup>**  
● Leather seat facings  
● Electrically heated sports front seats with tilt and lumbar adjustment  
● Front passenger's seat height adjuster



**Panoramic Roof Pack<sup>13</sup>**  
● Four glass roof panels  
● Roof-mounted storage console for front and rear passengers  
● Alloy-effect roof rails  
● Heat-reflective windscreen



### Seat Comfort Pack 1

● Driver's seat with tilt and lumbar adjustment



### Seat Comfort Pack 2

● Front passenger's seat with tilt, height and lumbar adjustment

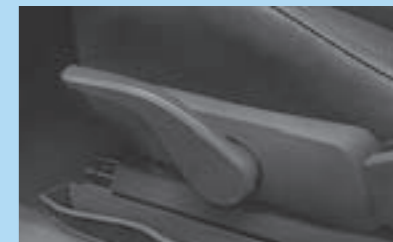

### Towing Pack<sup>14</sup>

● Trailer stability programme  
● Hill Start Assist (HSA)  
● Tyre deflation detection system  
● Cruise control  
● Detachable tow bar

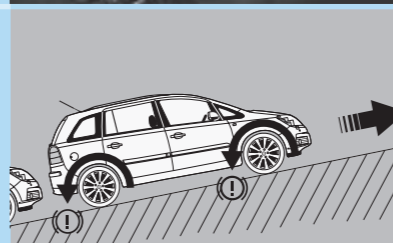

### VXR Styling Pack One

● Body-colour lower front spoiler/rear lower skirt/rear roof spoiler and side sills



### FlexOrganiser<sup>®</sup> Pack

● 3D storage net  
● Side net pocket  
● Four side rail hooks  
● Four side rails



### FlexOrganiser<sup>®</sup> accessories

Vauxhall also offers a range of FlexOrganiser<sup>®</sup> features as part of its comprehensive collection of accessories.

For details of FlexOrganiser<sup>®</sup> accessories, shown right, please consult your Vauxhall retailer.





Steering wheel mounted audio controls.



Roof-mounted removable DVD player.



Twin Audio® system.

## Audio and communications availability

### Features

#### CD 30 stereo radio/CD player

- AM/FM stereo radio with 24 station presets
- RDS with Traffic Programme
- CD player
- Remote display
- 17 watts per channel output
- 6 speakers

#### CD 30 MP3 stereo radio/CD player with MP3

- AM/FM stereo radio with 24 station presets
- RDS with Traffic Programme
- CD player with MP3 capability
- Remote display
- 20 watts per channel output
- 7 speakers

#### CD 70 stereo radio/CD player with MP3/satellite navigation

- AM/FM stereo radio with 40 station presets
- RDS with Traffic Programme
- CD player with MP3 capability
- Satellite navigation system
- Remote colour display
- 20 watts per channel output
- 7 speakers

Roof-mounted removable DVD player (retailer-fit)<sup>17</sup>

Twin Audio® system (only available with optional audio units)

Mobile phone system with Bluetooth® (does not include phone or cradle)

Steering wheel mounted audio controls

Roof-mounted flexible aerial

	Exp.	Life	Club	Design	SRi
CD 30 stereo radio/CD player	●	●	●	●	●
CD 30 MP3 stereo radio/CD player with MP3		○	○	○	○
CD 70 stereo radio/CD player with MP3/satellite navigation		○ <sup>3, 16</sup>	○	○	○
Roof-mounted removable DVD player (retailer-fit) <sup>17</sup>		○	○	○	○
Twin Audio® system (only available with optional audio units)			○	○	○
Mobile phone system with Bluetooth® (does not include phone or cradle)		○ <sup>3, 16</sup>	○	○	○
Steering wheel mounted audio controls			●	●	●
Roof-mounted flexible aerial	●	●	●	●	●

#### Roof-mounted removable DVD player

The retailer-fit DVD player available for Zafira features a 7-inch screen with excellent picture quality and brightness – very important features for in-car use. Mounted in the roof of the vehicle, it's ideally situated to allow good visibility for all five passengers in the second and third rows.

Not only that but it is also removable from the vehicle, offering the advantages of extra security and the ability to continue watching films after the journey has ended – it can even be connected up to a TV if required.

Included within the DVD player package are two sets of wireless headphones with carry cases, a remote control and a mains electricity adaptor.

#### MP3 CD player

An MP3 is a compressed sound or music file which, due to its small size, takes up less space on a compact disc, which means that more tracks can be recorded onto a CD. It's possible to fit almost 10 hours of music onto one CD, and, in a way, turns a single-disc CD/MP3 player into a multi-disc autochanger. Providing you have access to a compatible computer to create the MP3 tracks, you can compress your CD collection and create your own compilations – and you won't have to drive around with all your original CDs in the car.

#### Twin Audio® system

The Twin Audio® system allows the two rear passengers to listen to the same music source (i.e. radio or CD) through personal headphones, independently of one another and each with their own volume controls.

They are also free to select CD mode while the front occupants are tuned into the radio (or vice-versa) and make full use of functions like track skip and autosearch.



#### Satellite navigation

The CD 70 satellite navigation system uses the international network of GPS (Global Positioning System) satellites, linked to a comprehensive CD-ROM mapping system, to determine your precise location and guide you to your chosen destination virtually anywhere in mainland Britain.

Vauxhall's satellite navigation systems have been widely acclaimed for their ease of use and high level of information and Zafira is no exception. There is now a split-screen facility, whereby half of the screen displays the route as a map, while directional arrows give immediate information about road junctions. The audible direction guidance prompt now gives details of road numbers and motorway junction numbers, while you can also plan your route to avoid toll roads, if required.

Furthermore, the use of the system has been simplified with regard to entering your destination address. Rather than entering the address line by line, the user can find their destination via the on-screen map. Additionally, the system will save the car's current location as an address for ease of use.

The CD 70 also features Traffic Message Channel (TMC), a specific application of RDS used for broadcasting real-time traffic information, delivered to the driver either visually or verbally. TMC can also offer dynamic route guidance – alerting the driver to a problem on the planned route and calculating an alternative route to avoid the incident.

#### Standard features (CD 70)

- Automatic re-routing on request
- CD-ROMs available for all major European countries
- CD-ROM may be replaced by audio CD after route is selected
- Display of estimated time remaining and distance to destination
- Exact location of vehicle using the GPS (Global Positioning System) and speed sensor
- Choice of four different route types: using motorways/avoiding motorways/shortest distance/shortest journey time
- Store up to 100 personal destinations
- Last 10 destinations stored automatically

#### Mobile phone system with Bluetooth®

Vauxhall's optional factory-fit dual-band mobile phone system features voice control and wireless connection to phones featuring Bluetooth® technology.

Configuring a Bluetooth® phone to work with Vauxhall's mobile phone system takes mere seconds so, as soon as a connection is achieved, features such as the phonebook are automatically displayed on Zafira's graphic display screen and navigated via either the steering wheel mounted controls or the multi-function button on the radio. Making and receiving calls is easy, especially as the voice activation feature means that your concentration on the road won't be affected.

Mounted on the centre console, the phone system base unit can be fitted with a cradle (available as an accessory) for many different mobile phones. A list of cradles is featured in the Car and Accessory Price Guide.



CD 70 satellite navigation system.



Mobile phone system with Bluetooth®.

- = Standard equipment.
- = Optional at extra cost.
- Exp. = Expression.

- 3 = Includes map reading light, sunvisors with illuminated vanity mirrors and rear reading lights.
- 16 = Steering wheel mounted audio controls are also included on Life models.
- 17 = Not available in conjunction with Panoramic roof pack.

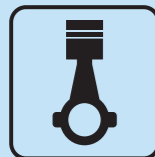

**200PS**  
2.0i 16v turbo – the most powerful petrol engine in its class



High-performance petrol engines.

**Petrol engines**

	1.6i 16v ECOTEC-4 Twinport	1.8i 16v VVT ECOTEC-4	2.2i 16v Direct ECOTEC-4 aluminium	2.0i 16v turbo ECOTEC-4
Capacity	1598cc	1796cc	2198cc	1998cc
Maximum power	105PS (77kW) @ 6000rpm	140PS (103kW) @ 6300rpm	150PS (110kW) @ 5600rpm	200PS (147kW) @ 5400rpm
Maximum torque	150Nm (111 lb.ft.) @ 3900rpm	175Nm (129 lb.ft.) @ 3800rpm	215Nm (159 lb.ft.) @ 4000rpm	262Nm (193 lb.ft.) @ 4200rpm
Configuration	4 cylinders, 4 valves per cylinder, double overhead camshafts			
Fuel/induction system	Naturally aspirated with vacuum-controlled Twinport inlet ports Multi-point sequential fuel injection	Naturally aspirated Variable Valve Timing (VVT) Multi-point sequential fuel injection	Naturally aspirated Direct fuel injection	Water-cooled turbocharger with air-cooled intercooler Multi-point sequential fuel injection
Service intervals	20,000 miles or 1 year (whichever occurs sooner)			
<b>Benefit in kind company car taxation – 2006/07 and 2007/08 tax years</b>				
Manual	22%	24%	26%	32%
Easytronic/automatic	-	23%	27%	-

The advanced 1.8i 16v VVT (Variable Valve Timing) engine made its debut in Zafira. Double Continuous Variable Cam Phasing (DCVCP) allows at least 90% of the maximum torque to be available between 2200 and 6200rpm, ensuring good performance and flexibility at all engine speeds – along with less frequent gear changes.

Compared to the previous Zafira's 1.8i 16v unit, the new engine develops 12% more power – yet consumes 4% less fuel.

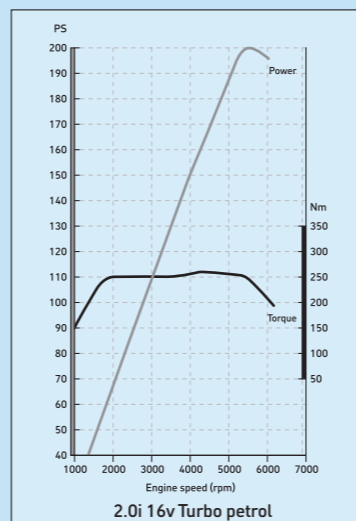
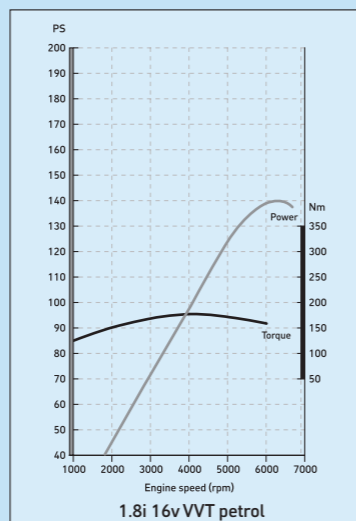

**Diesel engines**

	1.9CDTi (120PS) ECOTEC-4 Turbo diesel	1.9CDTi 16v (150PS) ECOTEC-4 Turbo diesel
Capacity	1910cc	1910cc
Maximum power	120PS (88kW) @ 3500rpm	150PS (110kW) @ 4000rpm
Maximum torque	280Nm (206 lb.ft.) @ 2000-2750rpm	320Nm (236 lb.ft.) @ 2000rpm
Configuration	4 cylinders, 2 valves per cylinder Single overhead camshaft	
Fuel/induction system	Variable geometry turbocharger with intercooler. Common rail fuel injection	
Service intervals	20,000 miles or 1 year (whichever occurs sooner)	
<b>Benefit in kind company car taxation – 2006/07 and 2007/08 tax years</b>		
Manual	23%	23%
Automatic	28%	28%

- = This engine/transmission combination is not available.

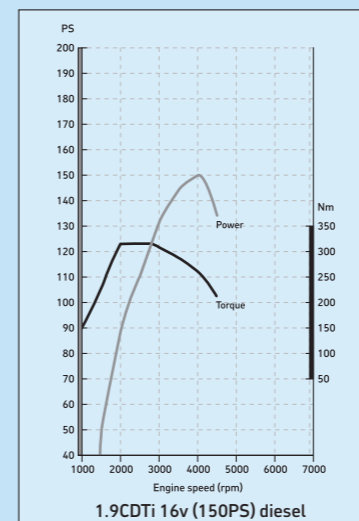
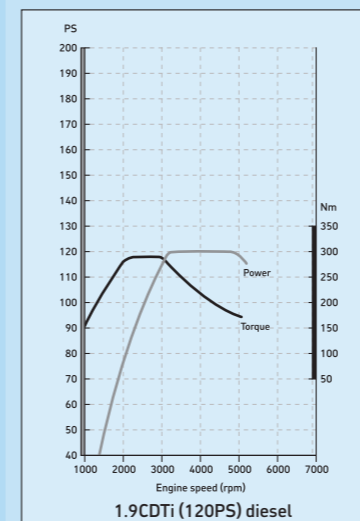

**150PS**  
1.9CDTi 16v – one of the most powerful diesel engines in its class



Common rail turbo diesel engines.



**47.1mpg**  
Refined, powerful,  
yet economic  
diesel engines



Performance, fuel economy and emissions

Model	Performance (manufacturer's figures)			Fuel economy mpg (litres/100km)			CO <sub>2</sub> emissions (g/km)
	Max. speed (mph)	Acceleration (secs) 0-60mph	30-50mph (4th gear)	Urban driving	Extra-urban driving	Combined figure	
<b>Manual 5-speed</b>							
1.6i 16v Twinport	110	13.3	9.2	29.7 (9.5)	47.1 (6.0)	38.7 (7.3)	175
1.8i 16v VVT	122	10.8	8.1	27.4 (10.3)	44.1 (6.4)	36.2 (7.8)	187
<b>Manual 6-speed</b>							
2.2i 16v Direct	124	9.9	7.6	25.0 (11.3)	44.1 (6.4)	34.4 (8.2)	197
2.0i 16v Turbo	140	8.4	6.0	21.2 (13.3)	38.7 (7.3)	29.7 (9.5)	228
1.9CDTi (120PS)	116	11.4	6.8	37.2 (7.6)	55.4 (5.1)	47.1 (6.0)	162
1.9CDTi 16v (150PS)	126	9.7	6.0	36.7 (7.7)	54.3 (5.2)	46.3 (6.1)	165
<b>Easytronic 5-speed</b>							
1.8i 16v VVT	122	12.1	-	28.0 (10.1)	45.6 (6.2)	37.2 (7.6)	182
<b>Automatic 4-speed</b>							
2.2i 16v Direct	118	10.8	-	24.4 (11.6)	42.2 (6.7)	33.2 (8.5)	204
<b>Automatic 6-speed</b>							
1.9CDTi (120PS)	113	11.7	-	28.8 (9.8)	49.6 (5.7)	39.2 (7.2)	194
1.9CDTi 16v (150PS)	123	10.0	-	28.8 (9.8)	49.6 (5.7)	39.2 (7.2)	194

The fuel consumption figures shown comply with EC directive 1999/100 to provide a realistic indication of fuel consumption by taking into account everyday driving conditions, such as cold starts, acceleration and braking. These figures take account of the vehicles kerbweight, ascertained in accordance with the above regulation. **Important:** the results given relate to the particular car tested. Driving style, road and traffic conditions, vehicle mileage and standard of maintenance may also affect fuel consumption; therefore the results do not express or imply any guarantee of fuel consumption attainable.

Vauxhall Assistance and warranties\*

- A one-year unlimited mileage manufacturer's warranty
- Second and third year no-fee customer option warranty up to 60,000 miles (from first registration)
- Vauxhall Assistance for 12 months from first registration
- Six years' body panel anti-perforation warranty

\* = Warranty is only available on vehicles sourced from Vauxhall Motors Ltd. Terms and conditions apply - please see your Vauxhall retailer for details.

Optional transmissions

**Five-speed Easytronic transmission – 1.8i VVT 16v models:** Easytronic is a five-speed manual gearbox with a fully automatic mode. In manual mode you simply push the lever forward or back to shift gears up or down, while the fascia display tells you what gear you're in. Switch to fully automatic mode and you'll have many of the features of a regular automatic, including kickdown. Since there's no clutch pedal, Easytronic is ideal for effortless town driving.

**Four-speed automatic transmission – 2.2i 16v Direct models:** Electronically controlled with an adaptive driving programme, which tailors its gear changes to match your driving conditions. There is also a winter mode, which selects a higher than normal gear to reduce the possibility of wheelspin in icy conditions.

**Six-speed automatic transmission with Active Select function – 1.9CDTi (120/150PS) models:** The electronically controlled adaptive driving programme can tailor gear changes to match your driving conditions, while the winter mode selects a higher than normal gear to reduce the possibility of wheelspin in icy conditions. The Active Select manual mode allows the gear lever to be used like a manual gearbox – you simply push the lever forward or back to change up or down the gears.

Steering

- Electro-hydraulic power-assisted steering
- Turning circle (kerb-to-kerb): All models – 11.10m (36.4ft)

Brakes

- Anti-lock Braking System (ABS)
  - Dual circuit, diagonally split braking system
- 1.6i 16v**  
Front ventilated discs: 280mm diameter  
Rear discs: 264mm diameter
- 1.8i 16v VVT**  
Front ventilated discs: 280mm diameter  
Rear discs: 264mm diameter
- 2.2i 16v Direct**  
Front ventilated discs: 308mm diameter  
Rear discs: 264mm diameter
- 2.0i 16v Turbo**  
Front ventilated discs: 308mm diameter  
Rear discs: 278mm diameter
- 1.9CDTi (120/150PS)**  
Front ventilated discs: 308mm diameter  
Rear discs: 264mm diameter

Suspension

**Front:** Independent. Lightweight MacPherson struts with gas-pressure dampers and coil springs. Anti-roll bar. Hydro-formed subframe offers increased lateral stiffness. Hydraulic control arm bushing gives improved insulation from road noise.

- Design 2.2i 16v Direct/2.0i 16v Turbo/1.9CDTi 16v (150PS) and all SRi models – uprated springs and dampers
- SRi – Interactive Driving System with Continuous Damping Control, optional at extra cost – see **D8** on page 63

**Rear:** Lightweight torsion beam rear axle with one-piece, hollow cast trailing arms. Built-in anti-roll bar. Progressive-rate double conical mini-block springs and gas-pressure dampers.

- Design 2.2i 16v Direct/2.0i 16v Turbo/1.9CDTi 16v (150PS) and all SRi models – uprated springs and dampers
- SRi – Interactive Driving System with Continuous Damping Control, optional at extra cost – see **D8** on page 63

Body

- Aerodynamic drag co-efficient: Cd 0.31

Fuel tank capacity

- All models – 58 litres (12.8 gallons)

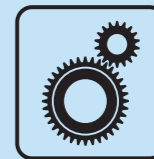

**6-SPEED**  
Six-speed manual  
and automatic  
transmissions  
available



Six-speed automatic transmission.



MacPherson strut front suspension.

Exterior dimensions millimetres (inches)

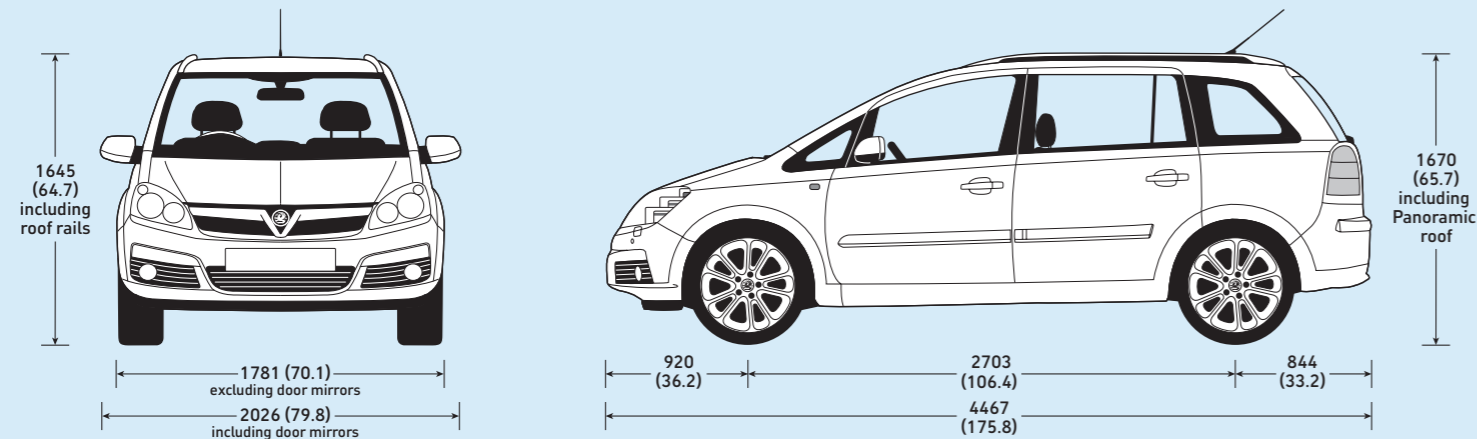

Loadspace dimensions

	mm	inches
Maximum floor length – behind front seats, second-row seat back lowered	1809	71.2
Maximum floor length – behind front seats, second-row seat folded and stowed	1525	60.0
Maximum floor length – behind second-row seat	1088	42.8
Maximum floor length – behind third-row seat	405	15.9
Maximum floor width	1114	43.9
Width between wheel arches	1071	42.2
Tailgate aperture height	893	35.2
Tailgate aperture width	1136	44.7

Luggage capacities (measured using the ECIE method)

	litres	cu.ft
Behind third-row, to glass line	140	4.9
Behind second-row, to glass line	645	22.8
Behind front seats, to glass line	1070	37.8
Behind front seats, to roof	1820	64.3

Flex7® seat configurations

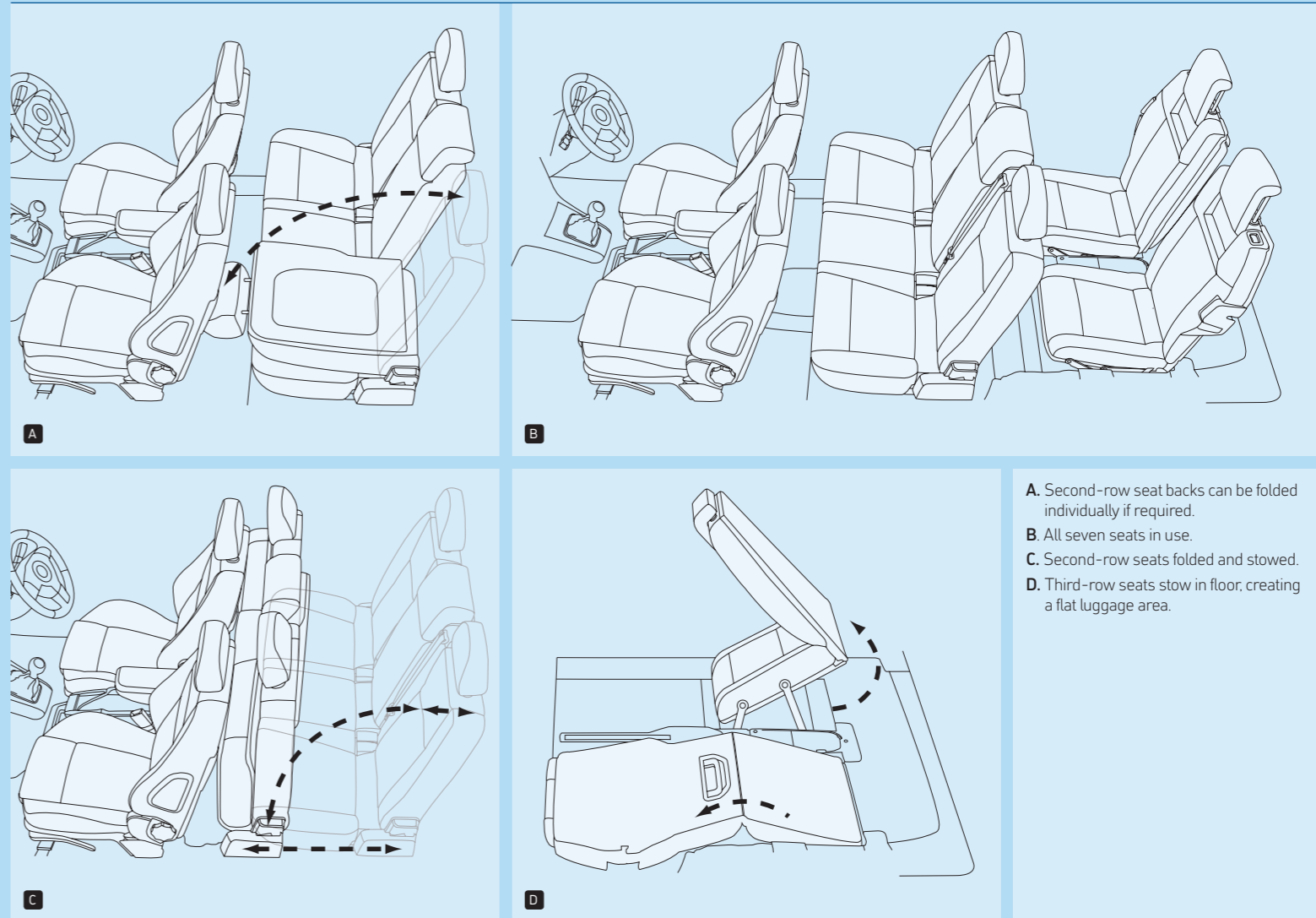

- A. Second-row seat backs can be folded individually if required.
- B. All seven seats in use.
- C. Second-row seats folded and stowed.
- D. Third-row seats stow in floor, creating a flat luggage area.



**1500kg**  
Maximum towing weight



**652kg**  
Maximum carrying capacity



**1820 litres**  
Maximum luggage capacity

**Weights and towing data** kg

	Kerbweight (Gross vehicle weight)	Max. towing weights Trailer with brakes (without brakes)
1.6i 16v Expression	1430 (2075)	1000 (750)
1.6i 16v Life	1445 (2090)	1000 (750)
1.6i 16v Club	1455 (2090)	1000 (750)
1.8i 16v VVT Life (inc. Easytronic)	1443 (2095)	1200* (750)
1.8i 16v VVT Club (inc. Easytronic)	1453 (2095)	1200* (750)
1.8i 16v VVT Design (inc. Easytronic)	1468 (2095)	1200* (750)
1.8i 16v VVT SRi	1463 (2095)	1200 (750)
2.2i 16v Direct Life	1510 (2150)	1500 (750)
2.2i 16v Direct Life automatic	1535 (2175)	1500 (750)
2.2i 16v Direct Club	1512 (2150)	1500 (750)
2.2i 16v Direct Club automatic	1537 (2175)	1500 (750)
2.2i 16v Direct Design	1526 (2150)	1500 (750)
2.2i 16v Direct Design automatic	1551 (2175)	1500 (750)
2.2i 16v Direct SRi	1523 (2150)	1500 (750)
2.2i 16v Direct SRi automatic	1548 (2175)	1500 (750)
2.0i 16v Turbo Design	1551 (2175)	1500 (750)
2.0i 16v Turbo SRi	1548 (2175)	1500 (750)
1.9CDTi (120PS) Life	1553 (2195)	1300 (750)
1.9CDTi (120PS) Life automatic	1583 (2225)	1400 (750)
1.9CDTi (120PS) Club	1558 (2195)	1300 (750)
1.9CDTi (120PS) Club automatic	1588 (2225)	1400 (750)
1.9CDTi (120PS) Design	1569 (2195)	1300 (750)
1.9CDTi (120PS) Design automatic	1599 (2225)	1400 (750)
1.9CDTi (120PS) SRi	1566 (2195)	1300 (750)
1.9CDTi (120PS) SRi automatic	1596 (2225)	1400 (750)
1.9CDTi 16v (150PS) Design	1569 (2205)	1500 (750)
1.9CDTi 16v (150PS) Design automatic	1599 (2235)	1500 (750)
1.9CDTi 16v (150PS) SRi	1566 (2205)	1500 (750)
1.9CDTi 16v (150PS) SRi automatic	1596 (2235)	1500 (750)

\* =On models fitted with the optional Easytronic transmission the maximum towing weight for a trailer with brakes is 1300kg.

**Gross vehicle weight** is the total permissible weight of the vehicle including passengers and their luggage. To determine total carrying capacity, deduct kerbweight from gross vehicle weight. The **maximum roof rack loading** should not exceed 75kg. The **maximum towing weights** are based on the ability of the car, with two occupants of 70kg each, to restart on a 12% gradient, which is approximately 1 in 8.3, at sea level. At altitudes above 1500 metres, the engine output may drop with a corresponding reduction in towing capability. Any extra weight, such as luggage or additional passengers, should be deducted from the maximum towing weight. With a trailer fully loaded, **maximum noseweight** should not exceed 75kg. Always fit Vauxhall towing attachments and accessories available from your Vauxhall retailer.

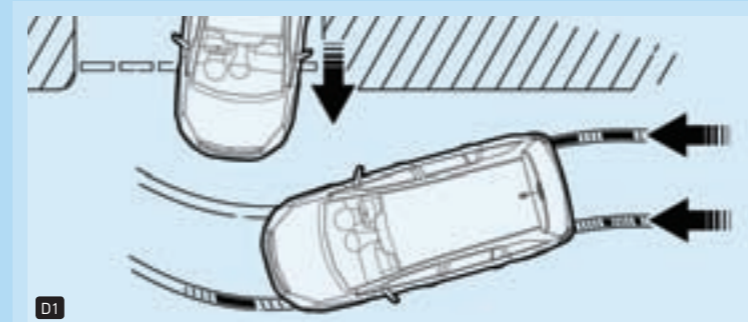

**Anti-lock Braking System (ABS) with Cornering Brake Control (CBC)**  
**D1.** Cornering brake control makes the car easier to control in extreme situations, particularly when braking sharply on a bend. It is particularly effective when carrying out emergency procedures, such as avoiding a child's ball that's rolled out from the kerb. The system works by sensing the different rotational speeds of the individual road wheels and co-ordinating the level of braking pressure applied to each wheel. CBC is an integral part of Zafira's comprehensive ABS.

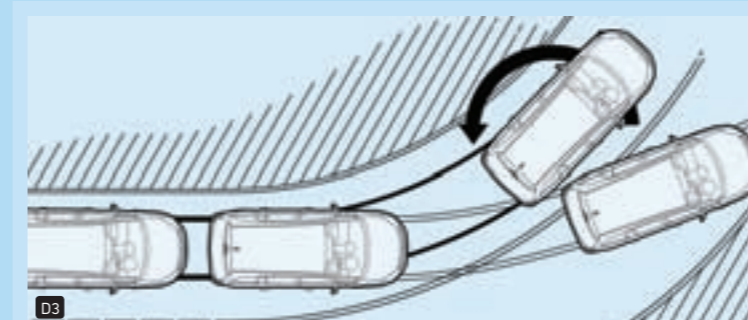

**Electronic Stability Programme-plus (ESP-plus)**  
**D3.** ESP-plus provides enhanced yaw compensation during understeer or oversteer. The system works by monitoring the front and rear of the car, comparing their respective directions of travel going in to the bend with the input received through the steering wheel. If the vehicle starts to slide, it applies corrective braking to the appropriate wheel, or wheels, compensating for the slide and helping you regain control more rapidly.

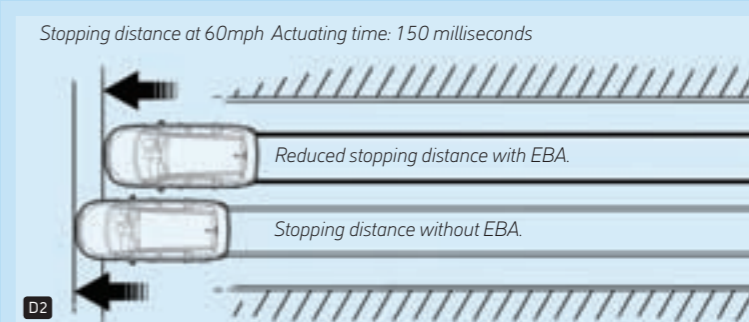

**Emergency Brake Assist (EBA)**  
**D2.** Emergency brake assist detects the urgency with which the brake pedal is pressed and rapidly increases the pressure to the maximum the system can provide, shortening stopping distances. It also enhances pedal feel.

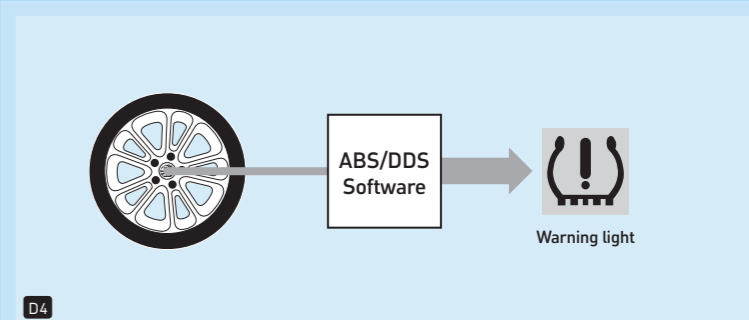

**Tyre deflation detection system**  
**D4.** The deflation detection system works without specific sensors, identifying pressure loss through changes in the rolling radius of the tyres by using the car's ABS sensors to measure changes in wheel speed brought on by a sudden reduction in tyre size. A warning light illuminates in the event of rapid tyre deflation. Available as part of the Towing pack



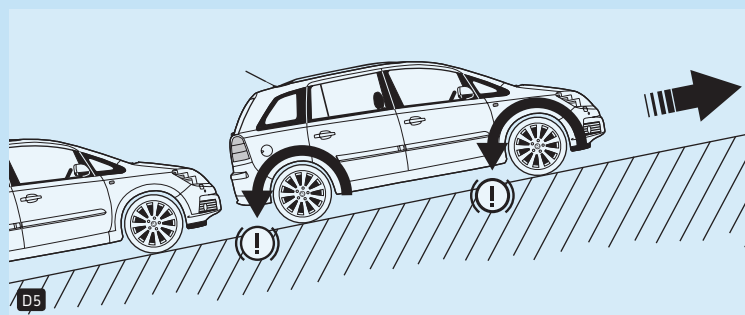

**Hill Start Assist**

**D5.** Hill Start Assist maintains the brake pressure for 1.5 seconds after the brake pedal has been released when pulling away on a gradient of 5% or more; this helps prevent the vehicle from rolling back should the driver release the brake pedal before first applying the handbrake. The pressure is released as soon as the driver presses the accelerator and the car begins to move forward.



**Sport switch**

**D7.** The Sport switch, standard on Design 2.2i 16v Direct/2.0i 16v Turbo/1.9CDTi 16v (150PS) and all SRI models, improves the responses of both the steering and throttle, giving the driver sharper initial throttle response and crisper turn-in when cornering. On vehicles fitted with automatic transmission, the Sport switch also controls the transmission Sport mode.

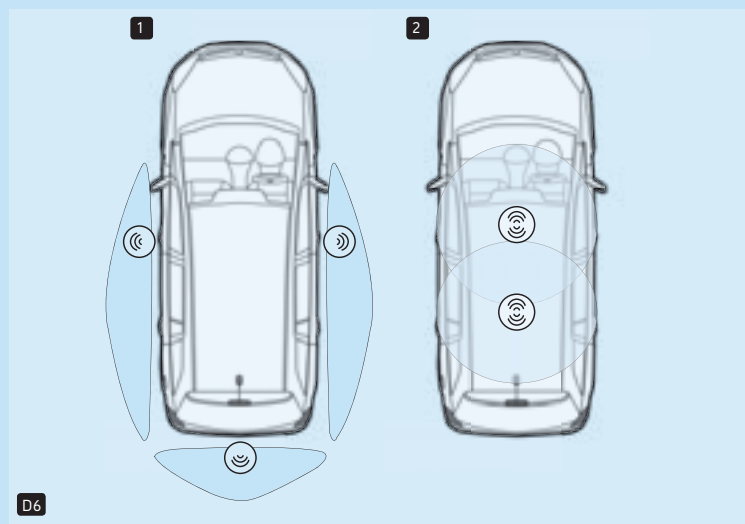

**Keyless entry and start**

**D6.** Available as an option, the keyless entry and start system means that the driver need never remove their key fob from their pocket. When approaching the car, sensors in the front door handles and rear bumper **1** detect the driver's proximity and automatically unlock the doors or boot when the handle is pulled.

When in the car, two internal sensors **2** activate the ignition and release the electronic steering lock, enabling the driver to start or stop the engine merely by pressing the dashboard-mounted Start/Stop button.

Upon leaving the vehicle, the driver can lock it by either pressing a button on the key fob like a convention system, or by simply touching one of the sensors on the external handles of the front doors. Either method will also close any open windows or sunroofs.

The system also offers excellent theft protection by its use of sophisticated cryptographic algorithms.

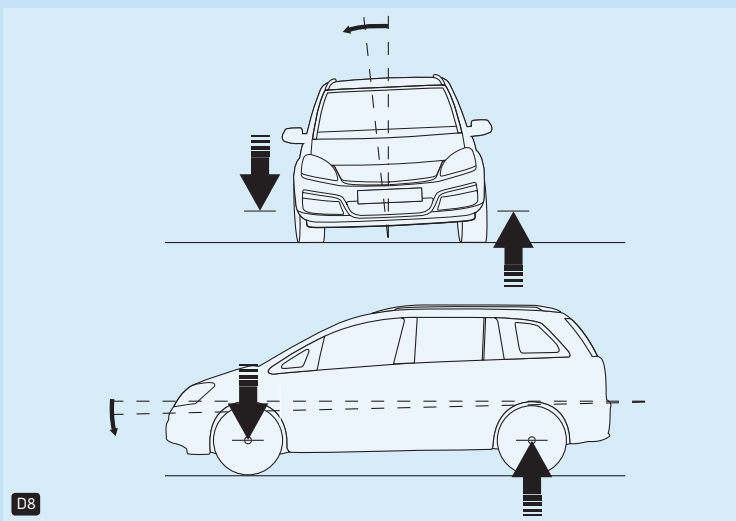

## IDS-plus with Continuous Damping Control (CDC)

**D8.** The Interactive Driving System (IDS-plus) chassis – available on SRi models – offers the Zafira driver an even more sporting driving experience, thanks mainly to the electronic control of the suspension. Pressing the Sport switch activates the CDC function – CDC monitors the roll, pitch and yaw of the car, and changes the rate of damping on each wheel to optimise the handling, effectively stiffening the suspension – but selectively. This means the vehicle will exhibit a reduced rate of roll and pitch, making it more responsive during direction changes and more settled during the braking/turn-in/acceleration transition when cornering. CDC is a major breakthrough in the Zafira segment.

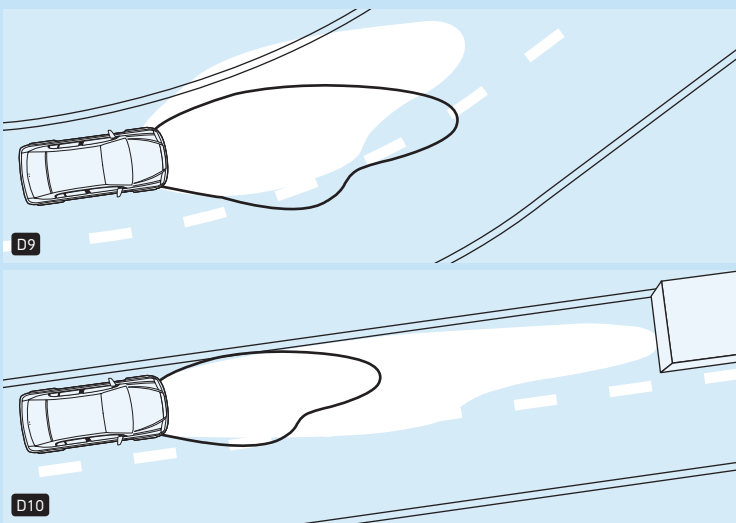

## Adaptive Forward Lighting (AFL)

Adaptive Forward Lighting is a sophisticated new lighting system that allows drivers to see around corners. This optional bi-xenon system employs two main functions:

### Curving Light

**D9.** Controlled by a combination of steering wheel movement and sensors for the vehicle's speed and yaw angle, the Curving Light function allows the headlight beam to move up to 15 degrees left or right of the straight ahead position. This ensures the light is always following the trajectory plotted by the front wheels, rather than simply pointing straight ahead.

### Motorway Light

**D10.** At speeds above 65mph, AFL raises the dipped headlight beam to extend the range of vision for increased safety at higher speed. The beam automatically returns to its normal position when the car falls below that speed. Zafira is one of the first cars in its class to offer such technology.