

## Trust Vauxhall

### Protecting the environment

Vauxhall's commitment to the environment is demonstrated by our products' many environmental awards, won both through the use of more recycled materials and by becoming cleaner and more efficient. For information on Vauxhall's efforts to achieve an environmentally sustainable future, see [www.vauxhall.co.uk/recycling](http://www.vauxhall.co.uk/recycling).

### Fleet Customer Services

Our dedicated support services for fleet managers includes factory demonstrators and information on whole life costs, company car taxation and finance. For further information please call **0870 010 0651**.

### Sureguard protection

Sureguard Assistance offers the benefits of Vauxhall Assistance for three years from first registration, while Sureguard Warranty also provides a parts and labour warranty for high-mileage or long-term owners. For details contact your local Vauxhall retailer or call **0870 752 7020**.

### Business Lease

Business Lease, from GMAC, offers the versatility of a purchase-based finance plan, while making the most efficient use of tax and cash-flow benefits for VAT-registered business users. It's available for all Vauxhall Commercial Vehicles up to 12 months old and offers highly flexible term lengths, variable deposits and a choice of payment profiles. Ask your retailer for full details.

### Business First

Available to business users only, Business First enables you to drive a new vehicle without a large, initial financial outlay. You pay to use the vehicle, not to own it. The vehicle is provided over a predetermined period, and when that period comes to an end the vehicle is returned. Ask your retailer for full details.

### Servicing and maintenance

The best way to maximise the performance and reliability of your Vauxhall is to have all routine servicing and maintenance carried out at a Vauxhall Commercial Vehicle retailer. There are over 200 light commercial vehicle and 120 heavy commercial vehicle retailers nationwide.

### In the event of an accident...

Vauxhall Accident Support helps keep you mobile following an accident. Benefits include scene-of-accident advice, message service, assistance with claims and vehicle recovery. Call **0800 010 304** for a free driver's pack.

### Premier Service Centres

Our new Premier Service Centres feature extended opening hours, a guaranteed same day repair service (provided the parts are in stock) and an appointment-free service for diagnosis and repairs taking less than 90 minutes. All repairs are carried out within 24 hours of diagnosis, while suitable alternative transport can be arranged to keep you mobile.\*

\*= Terms and conditions apply.

### For more information...

For a brochure on any Vauxhall model (up to a maximum of three per caller) or location of your nearest retailer, call **0845 600 1500**.

Alternatively, details can be found on our website at: [www.vauxhall.co.uk](http://www.vauxhall.co.uk)

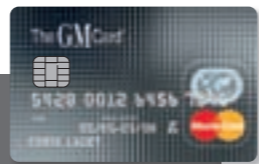

- Save up to **£1000\*** on a new Vauxhall with The GM Card
- 100 Rebate Points worth **£100** when you use The GM Card for the first time
- Rebate Point saving is on top of any discount or offer negotiated with the Retailer
- Earn 3 Rebate Points (**£3**) for every **£100** you spend

**Typical 14.9% APR variable**

To apply call **0845 746 2777** or visit [www.gmcard.co.uk](http://www.gmcard.co.uk).

For a copy of this brochure in large print, Braille or on audio tape, please call **0845 600 1500**, or via our textphone service on **18001 08456 785 785**.

The GM Platinum Card is issued by HFC Bank Limited and is available to persons aged 18 years or over and resident in the UK (or 21 and over in the Channel Islands) and is subject to status and conditions. Written quotations are available upon request from The GM Platinum Card, PO Box 3615, Birmingham B3 2RJ. The typical APR quoted is the rate for new customers. \*Rebate Points are earned on purchases using The GM Platinum Card. Rebate Points are not earned on Balance Transfers or Cash Advances. You earn money off a new Vauxhall/Saab by accumulating Rebate Points under the Rebate Points Programme. Vauxhall Motors Ltd is solely responsible for the operation of the Rebate Points Programme, which is subject to the Rebate Points Programme Rules. You can redeem up to 2500 Rebate Points subject to the Model Line Maximum which will vary in amount in relation to different Vauxhall/Saab vehicle model lines and unlimited Partner Points. Rebate Points and unlimited Partner Points are redeemable as discounts on a new Vauxhall/Saab vehicle and must be redeemed four years from the issue date. Rebate Points may not be redeemed by Motability Contract Hire customers. The GM Card is a trading name and style of both HFC Bank Limited and Vauxhall Motors Ltd. HFC Bank registered in England No. 1117305. Registered Office: North Street, Winkfield, Windsor, Berkshire SL4 4TD is authorised and regulated by the Financial Services Authority. Member HSBC Group. HFC Bank Limited is not a member of the same group of companies as Vauxhall Motors Ltd, Saab GB Limited or GMAC (UK) plc. Vauxhall Motors Ltd, Registered Office: Griffin House, Osborne Road, Luton, Bedfordshire LU1 3YT. Registered in England number 135767. - CN6/0987.

Every effort has been made to ensure that the contents of this publication were accurate and up-to-date at the time of going to press (January 2007). Vauxhall vehicles are equipped with components manufactured by various General Motors operating units and outside suppliers. The Company reserves the right to alter specifications and withdraw products from sale without notice. Any such alterations will be notified to Vauxhall retailers at the earliest opportunity; please consult your local retailer for the latest information. The specifications detailed within this brochure are not necessarily applicable to alternative models such as Special Editions. Details of any such models will be contained in specific literature or found on the Vauxhall website. Please note that Vauxhall retailers are not the agents of Vauxhall Motors Limited and are not authorised to bind the Company by any specific or implied undertaking or representation. It is advisable to ensure that your motor insurance policy provides adequate cover for additional fitted options and accessories. As part of Vauxhall's policy of environmental care, this brochure is printed on paper manufactured using Elemental Chlorine Free pulps from specially farmed, sustainable timber resources. All rights reserved. No part of this publication may be reproduced in any form or by any means, without the prior written permission of Vauxhall Motors Limited.

VM0606827 Published February 2007 (BMB/Graymatter) Vauxhall Motors Limited, Luton LU1 3YT



# Astravan

The ultimate drivers' van





# DOING THE BUSINESS

Whatever your load, Vauxhall Commercial Vehicles are designed to help you deliver a top quality job. For small loads, our light commercial vehicle range – New Corsavan, New Astravan and Combo – offers gross vehicle weights from 1615kg to 1995kg, superb reliability and the lowest possible running costs allied to a comprehensive three year/60,000 mile warranty.

Moving up a division, our medium and heavy vans, New Vivaro and Movano, have gross vehicle weights ranging from 2770kg to 3500kg. A wide range of payload, wheelbase, roof height, door and engine configurations allow you to tailor your panel van to meet your specific operating needs. In addition, there are a variety of specialist conversions available for both New Vivaro and Movano, providing practical solutions for a host of transportation requirements. New Vivaro and Movano also offer high driver comfort, outstanding load-carrying capacity and a three year/100,000 mile warranty.

The New Astravan is already winning awards, recently being voted best in class in the AA/ALD MPG Marathon and also voted 'Editor's Choice 2006' in the *What Van?* magazine awards.

You can also rely on the fact that Vauxhall's nationwide network of retailers will meet all your servicing and maintenance needs. To minimise downtime, there is a growing network of Premier Service Centres, open a minimum of 70 hours a week to provide a fast, efficient repair service at times to suit you.



- Overview 4
- Dynamics 8
- Loadspace 10
- Efficiency 12
- Interior, safety and security 14
- Club 16
- Sportive 18
- Options and accessories 20
- Colours and trims 22
- Equipment and technical data 24

# NEW ASTRAVAN THE ULTIMATE DRIVERS' VAN





With all-new styling, it looks better than a van should. With new engines and transmissions, it performs better than a van should. And with a dynamic new chassis and more interior comfort, it drives better than a van should, too. But with even more carrying capacity and flexibility at the business end, it's exactly as a van should be. New Astravan. Club or Sportive. The ultimate drivers' van.

**COMMERCIAL MOTOR SAID...**

**'... initial impressions are that Vauxhall has a sure-fire winner that is in a class of its own.'**

AUGUST 2006



Max payload  
650kg



20,000 mile/1-year  
service intervals



Anti-lock  
braking system



Max. load floor  
length 2.68m with  
Flex bulkhead



Max. volume  
1.58m<sup>3</sup>



3-year/60,000 mile  
warranty



## DYNAMICS

- | Body-lock seatbelt pretensioners | Twin front airbags | Anti-lock Braking System (ABS) | Emergency Brake Assist (EBA)
- | Electronic Stability Programme-plus (ESP-plus) (standard on 1.9CDTi models, optional on all others) | 16-inch Structure wheels (Sportive)
- | 16-inch twin-spoke alloy wheels (optional) | Body-colour door mirrors, door handles and side-protection mouldings (Sportive)
- | Dark-tinted rear window (Sportive)

There's no doubt that it looks good, and it's great to drive too. But don't let that distract you. New Astravan is solid and dependable with a high level of safety and the load carrying capacity to handle the toughest assignments.



### COMMERCIAL MOTOR SAID...

**'A thorough drive around Snowdonia showed that all Astravan variants have outstanding handling.'**

AUGUST 2006

#### DYNAMIC CHASSIS

With precise power steering, genuine ride comfort and incredible agility, it's no surprise New Astravan drives more like a car than ever before. Yet the chassis is specially tuned to the hardworking demands of everyday van life.

#### GREAT LOOKS

Beautifully styled from every angle, New Astravan's sharp, modern lines make a positive statement about any business. Sportive models add extra visual appeal with body-colour door handles, mirrors and side-protection mouldings plus a dark-tinted rear window.

#### MUST HAVE SAFETY

New Astravan provides a safe working environment with front airbags, body-lock seatbelt pretensioners and ABS braking as standard. 1.9CDTi models also feature ESP-plus, helping you retain control of the van in emergency situations.



Anti-lock  
braking system

Like never before, New Astravan proves that it's not just about what you carry, it's how you carry it – allowing you to choose the right combination of high payload, flexible space and easy loading to suit your particular needs.

The New Astravan load compartment provides 1.58 cubic metres of highly versatile loadspace with up to 650kg maximum payload. The optional Flex bulkhead with fold-flat passenger seat extends maximum load floor length from 1.82 to 2.68 metres.

Easy loadability has always been a Vauxhall commercial vehicle strength. And New Astravan's high-lift tailgate reveals a low loading height, a high, wide loading aperture, and a load area that is longer (1.82m), taller (0.90m) and wider (1.38m) than ever before.

A standard half-height steel bulkhead and half-height plastic sidewall panelling provide valuable protection against shifting loads. In addition, six load restraint lashing eyes allow you to secure your load, avoiding potential damage.



LOADSPACE DIMENSIONS*	mm	inches
Max. tailgate aperture height	766	30.1
Max. tailgate aperture width	1024	40.3
Maximum load area height	900	35.4
Maximum load area width	1376	54.2
Width between wheel arches	1103	43.4
Load floor length	1825	71.8
Load floor length with Flex bulkhead	2680	105.5
Flex bulkhead aperture width	531	20.9
Flex bulkhead aperture height	276	10.9
Loading height (unladen)	591	23.3
LOADSPACE VOLUME	cu.m	cu.ft
All models (VDA method)	1.58	55.8

\*Please refer to pages 29-30 of the Specification section for more detailed loadspace, weight and towing data.



Max. payload  
650kg



Max. load floor  
length 2.68m with  
Flex bulkhead



Max. volume  
1.58m³



## LOADSPACE

- | High-lift tailgate | 1.58cu.m loadspace volume | Up to 650kg payload | Low loading height (591mm) | Half-height sidewall protection panelling
- | Illuminated load area | Load restraint lashing eyes | Half-height steel bulkhead | Flex bulkhead with fold-flat passenger's seat (optional on Club)
- | Upper load restraint mesh (optional, illustrated on page 10) | Roof rails (standard on Sportive, optional on Club) | Unglazed tailgate\* (optional, illustrated on page 10)

\*Introduction to be confirmed.

New Astravan works as hard for your bank balance as it does for your business. The wide choice of efficient petrol and common rail turbo diesel engines match high fuel economy with extended service intervals for low running costs.



**WHAT VAN? SAID...**

**'We tried the 1.3CDTi and we remain mightily impressed with this little engine.'**

SEPTEMBER 2006



**COMMON RAIL DIESELS**

New Astravan comes with a choice of three high-torque, high-economy common rail, 16-valve turbo diesel engines – 1.3CDTi, 1.7CDTi and 1.9CDTi, all backed by six-speed manual gearboxes, plus a six-speed automatic available on the 1.9CDTi.

**EFFICIENT PETROL ENGINE**

The 1.4i 16v with five-speed manual, provides 90PS and 125Nm of torque for high flexibility and pulling power, whatever your load. Twinport variable induction ensures both exceptional performance and great fuel economy too.

**LOW RUNNING COSTS**

Commercial vehicle operators understand why we keep New Astravan running costs low. Service intervals extend to 20,000 miles/one-year, plus there's a three-year/ 60,000 mile manufacturer's warranty.



3-year/60,000 mile warranty



20,000 mile/1-year service intervals



**EFFICIENCY**

- | 1.4i 16v petrol (90PS) | 1.3CDTi 16v turbo diesel (90PS) | 1.7CDTi 16v turbo diesel (100PS) | 1.9CDTi turbo diesel (120PS)
- | Five-speed manual gearbox (1.4i 16v) | Six-speed manual gearbox (all diesel models) | Six-speed automatic (optional on 1.9CDTi)
- | One-year unlimited mileage manufacturer's warranty | Second and third year no-fee customer option warranty up to 60,000 miles



*Astravan Sportive model illustrated.*

## RELAXED

- | Electric front windows
- | Driver's seat height adjuster
- | Reach and rake adjustable steering column
- | CD 30 stereo radio/CD player
- | CD 70 stereo radio/CD with MP3 capability/satellite navigation system (optional)
- | Sports-style seats with lumbar adjustment (Sportive)
- | Sports leather steering wheel (Sportive)
- | Matt chrome-effect finish for facia and instruments (Sportive)
- | Air-conditioning (standard on Sportive, optional on Club)
- | Door pockets
- | Electronic engine deadlock immobiliser
- | Remote control central deadlocking
- | Remote control security alarm system (optional)

When you're spending a long day on the road, it's good to know that New Astravan is spacious, comfortable and easy to drive. But it's also reassuring to know that New Astravan offers a high level of safety and security features as standard.



◀ Sportive models feature lumbar adjustment on sports-style seats.

### RELAXING CABIN

The New Astravan interior has a brighter, fresher look with more comfort and practicality, too. With a height-adjustable driver's seat and an adjustable steering column – plus sports-style seats with lumbar adjustment on Sportive – the perfect seating position is easy to find.

### GREAT FEATURES

New Astravan's features, such as electric windows, stereo CD player and adjustable seats, really make a difference out on the road. And on Sportive models you also get electrically adjustable and heated door mirrors, air-conditioning and leather-covered sports steering wheel.

▶ Optional satellite navigation system with colour monitor.



### PEACE OF MIND

A high level of easy-to-use security features is important to every van user. New Astravan's remote control central deadlocking, engine deadlock immobiliser and optional security alarm system ensure high levels of protection for your van and its cargo.

### VAN USER SAID...

**'Astravan is known in the trade as "the driver's van" – and behind the wheel you quickly understand why.'**

SEPTEMBER 2006



Power-assisted steering





◀ The spacious and comfortable Club interior is trimmed in hardwearing Alpha cloth.

▶ Electrically operated front windows with safety auto-reverse and one-touch facility are standard.



New Astravan Club offers a superb package of comfort, convenience and safety features that defy its highly competitive pricing. The wide engine choice – petrol and common rail diesel – plus extensive option and accessory choices make it easier than ever to tailor your model to your unique operating needs.

▶ A high quality stereo radio/CD player featuring 17 watts per channel is standard on Club models. A radio/CD player with six-disc autochanger and a radio/CD player with satellite navigation are available at extra cost.



## CLUB

| Choice of engines/transmissions: 1.3CDTi 16v diesel/six-speed, 1.7CDTi 16v diesel/six-speed, 1.9CDTi diesel/six-speed (automatic model also available) and 1.4i 16v petrol/five-speed | Driver's and passenger's airbags | Anti-lock Braking System (ABS) | Electric windows | Remote control central deadlocking | Steering column adjustable for reach and rake | Driver's seat height adjuster | CD 30 stereo radio/CD player | Half-height steel bulkhead | Upper load restraint mesh (optional)



## SPORTIVE

- | Choice of diesel engines: 1.3CDTi 16v, 1.7CDTi 16v and 1.9CDTi
- | Six-speed transmission\*
- | Sports-style seats with lumbar and height adjustment
- | Leather-covered sports steering wheel
- | Matt chrome-effect centre console
- | Matt chrome-effect inserts on fascia and doors
- | CD 30 stereo/CD player
- | Air-conditioning
- | Dark-tinted rear window
- | Twin electrically adjustable/heated door mirrors
- | Roof rails
- | 16-inch Structure wheels
- | Body-colour door mirrors, door handles and side-protection mouldings

\*Automatic also available on 1.9CDTi.



◀ Air-conditioning provides chilled air on hot days, faster demisting on damp days and a more pleasant atmosphere throughout the year.

With two-coat metallic or pearlescent paint, New Astravan Sportive puts the accent on sporting style. The body-colour exterior detailing, matt chrome-effect interior trim, sports-style seats and air-conditioning all look and feel great. But don't forget its appetite for hard work – with three powerful common rail turbo diesels and payloads of up to 647kg.

▶ Sportive models feature chrome-effect edging on instruments.



▶ Sportive models feature Silver Alpha cloth seat trim with matt chrome-effect inserts on fascia and doors.



# VAUXHALL BY DESIGN

Vauxhall by Design is all about choice – selecting your New Astravan then personalising it to suit the way you work. Whatever you need, we've made it easier with a choice of individual options, three special option packs and accessories available at highly attractive prices. For further information please ask your Vauxhall Commercial Vehicle retailer for more details.



Model illustrated features Flex bulkhead with fold-flat passenger's seat



◀ Twin-spoke alloy wheels.

▶ Satellite navigation system with colour monitor.



## OPTION PACKS

Interior pack  
 > Cigar lighter and ashtray  
 > 12-volt electrical accessory socket in load area

Intelligence pack  
 > Multi-function trip computer  
 > Rain-sensitive windscreen wipers  
 > Anti-dazzle rear-view mirror  
 > Automatic lighting control

Winter pack  
 > Heated seats  
 > Headlight washers  
 > Front fog lights

## INDIVIDUAL OPTIONS

> Electronic Stability Programme-plus (ESP-plus) with traction control (standard on 1.9CDTi models)  
 > 16-inch twin-spoke alloy wheels  
 > Satellite navigation system with colour monitor  
 > Remote control ultrasonic security alarm system  
 > Mobile phone system with Bluetooth® (does not include phone or cradle)  
 > Cruise control  
 > Upper load restraint mesh  
 > Flex bulkhead with fold-flat passenger's seat



◀ Rear window grille.

## ACCESSORIES

Vauxhall accessories are the right choice for your New Astravan. The list below is a brief selection of the accessories available, please contact your Vauxhall Commercial Vehicle retailer or visit our website [www.vauxhall-accessories.com](http://www.vauxhall-accessories.com)

- > Load carriers
- > Towing
- > Protection
- > Safety
- > Security
- > Practical
- > Audio and communications



Developed in conjunction with auto design specialists Irmscher International, a range of styling accessories are available to enhance and help personalise your New Astravan.

- > Interior styling
- > Exterior body styling
- > Styling pack
- > Sports silencer
- > Alloy wheels

◀ Irmscher rear roof spoiler.



◀ Load floor restraint net.



◀ Rear parking distance sensors.



◀ Mudflaps.

SOLID



Flame Red



Glacier White



Royal Blue

TWO-COAT METALLIC



Moonland



Star Silver



Silver Lightning

TWO-COAT PEARLESCENT



Black Sapphire



Panacotta



Peacock



Pomegranate Red



Ultra Blue

# COLOURS AND TRIMS

Top: Alpha cloth trim.  
Bottom: Silver Alpha cloth trim.

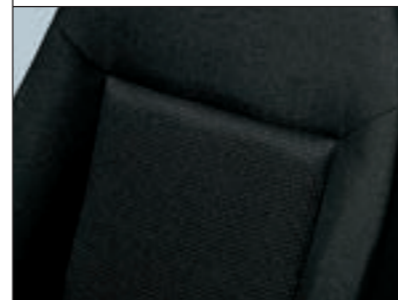

*Due to the limitations of the printing process the colours reproduced may vary from the actual colour. As a result they should be used as a guide only.*

*All Vauxhall Commercial Vehicle retailers have a comprehensive showroom colour display, with actual exterior paint samples available for inspection.*

*Please note: Certain alternative colours are available for special order on New Astravan. Restrictions apply so please consult your Commercial Vehicle retailer for more details.*

Sportive model illustrated features Silver Alpha cloth seat trim.



Exterior colours	Trim	
	Club Alpha cloth	Sportive Silver Alpha cloth
<b>Solid</b>		
Flame Red	Charcoal	Charcoal
Glacier White	Charcoal	Charcoal
Royal Blue	Charcoal	Charcoal
<b>Two-coat metallic*</b>		
Moonland	Charcoal	Charcoal
Star Silver	Charcoal	Charcoal
Silver Lightning	Charcoal	Charcoal
<b>Two-coat pearlescent*</b>		
Black Sapphire	Charcoal	Charcoal
Panacotta	Charcoal	Charcoal
Peacock	Charcoal	Charcoal
Pomegranate Red	Charcoal	Charcoal
Ultra Blue	Charcoal	Charcoal

\* = Two-coat metallic and pearlescent colours are available at no extra cost on Sportive models and at extra cost on Club models.



Driver's airbag.



Satellite navigation system.

## Safety

**Standard features** • Driver's airbag • Passenger's airbag • Anti-lock Braking System (ABS) with Electronic Brakeforce Distribution (EBD) • Emergency Brake Assist (EBA) (see page 28 for details) - Increases applied brake force in emergency braking situations • Height-adjustable head restraints • Pyrotechnic body-lock seatbelt pretensioner system - Tightens the seatbelt during the early stages of a frontal impact • Seatbelt force limiters - Reduces potential upper body injuries during a frontal impact • Height-adjustable inertia-reel seatbelts • Anti-submarining ramps in all seats - Help prevent occupants sliding underneath the lap belt during a collision • Energy-absorbing steering column • Pedal release system - Reduces potential injury to the driver's legs and feet during a severe frontal impact • Laminated windscreen • Side-impact protection beams • Reinforced passenger safety cell

Additional features	Club	Sportive
Electronic Stability Programme-plus (ESP-plus) with traction control <sup>1</sup> (see page 31 for details)	○	○
Side-impact airbags	○	○

## Facia, instruments and controls

**Standard features** • Trip odometer • Rev counter • Multi-function display showing time, date and outside air temperature (with ice warning function) • Steering column adjustable for reach and rake • Service-due indicator • Instrument panel light dimmer • Handbrake-on/low brake fluid level and low fuel level warning lights

Additional features	Club	Sportive
Three-spoke leather-covered sports steering wheel		●
Satin stone centre console	●	
Charcoal inserts on facia and doors	●	
Matt chrome-effect edging on instrument dials		●
Matt chrome-effect centre console and inserts on facia and doors		●
Multi-function trip computer	□	□
Cruise control	○	○

## Audio, navigation and communications

**Standard feature** • Roof-mounted flexible aerial

Additional features	Club	Sportive
<b>CD 30 stereo radio/CD player</b> • AM/FM stereo radio with 24 station presets • RDS with Traffic Programme • CD player • Remote display • 17 watts per channel output	●	●
<b>CD 70 stereo radio/CD player with MP3/satellite navigation</b> • AM/FM stereo radio with 40 station presets • RDS with Traffic Programme • CD player with MP3 capability • Satellite navigation system • Remote colour monitor with map function • Steering wheel mounted audio controls • 20 watts per channel output	○	○
Steering wheel mounted audio controls	○	○
Mobile phone system with Bluetooth® and steering wheel mounted audio controls (does not include phone or cradle)	○	○

## Seating

**Standard feature** • Height-adjustable driver's seat with reach and recline adjustment

Additional features	Club	Sportive
Sports-style driver's and passenger's seats with lumbar and height adjustment		●
Fold-flat passenger's seat back	○	
Map pockets on seat backs		●
Heated seats	□	□

## Interior

**Standard features** • Fade up/fade down courtesy lighting operated by door switches • Illuminated lidded glovebox • Twin sunvisors and dipping rear-view mirror • Door armrests • Door pockets • Carpeted cabin area • Air blend heater with four-speed fan

Additional features	Club	Sportive
Air-conditioning	○	●
Electro-chromatic anti-dazzle rear-view mirror	□	□
Cigar lighter and ashtray	□	□
12-volt electrical accessory socket in load area	□	□

## Security

**Standard features** • Remote control central deadlocking (doors, tailgate and fuel filler flap) • Visible Vehicle Identification Number (VIN) plate • 'Key left in ignition' audible warning • Freewheeling door locks • Electronic engine deadlock immobiliser • Electronic theft protection for audio equipment

Additional features	Club	Sportive
Folding key		●
Remote control ultrasonic security alarm system	○	○

## Load area

**Standard features** • Glazed tailgate • Half-height steel bulkhead • Loadspace sidewall half-height protection panelling • Load restraint lashing eyes (six) • Under load floor storage • Illuminated load area

Additional features	Club	Sportive
Upper load restraint mesh	○	○
Flex bulkhead with fold-flat passenger's seat	○	
Unglazed tailgate (introduction to be confirmed)	○ <sup>2</sup>	○



Air-conditioning.



Upper load restraint mesh.

● = Standard equipment.  
○ = Optional at extra cost.  
□ = Only available as part of an option pack

<sup>1</sup> = ESP-plus standard on 1.9CDTi models.  
<sup>2</sup> = Includes electrically heated door mirrors.



16-inch Structure wheel (Sportive model).



Electrically operated windows.



Roof rails.

## Wheels and tyres

Features	Club	Sportive
15-inch steel wheels with 195/65 R 15 low profile tyres and full-diameter flush covers (1.4i 16v/1.3CDTi 16v/1.7CDTi 16v)	●	
16-inch steel wheels with 205/55 R 16 low profile tyres and full-diameter flush covers (1.9CDTi)	●	
16-inch Structure wheels with 205/55 R 16 low profile tyres		●
16-inch twin-spoke alloy wheels (steel spare) with 205/55 R 16 low profile tyres	○	○
Tyre repair kit in lieu of spare wheel	N/C	N/C

## Exterior features

**Standard features** • Electrically operated windows with safety autoreverse and one-touch facility • Green-tinted glass • Heated rear window with automatic timed cut-off • Intermittent rear window wash/wipe • Windscreen wipers with variable intermittent facility and flick-wipe • Lights-on audible warning • LED centre brake light • Reversing light and rear fog light • Twin-jet windscreen washer nozzles • Twin gas-assisted tailgate and bonnet struts • Body-colour front and rear bumpers • Side-protection mouldings

Additional features	Club	Sportive
Rain-sensitive windscreen wipers	□	□
Automatic Lighting Control (ALC)	□	□
Headlight washers	□	□
Front fog lights	□	□
Internally adjustable door mirrors (wide-angle on driver's side)	●	
Electrically adjustable/heated door mirrors (wide-angle on driver's side)	○	●
Roof rails – charcoal (recommended when fitting roof carrier systems)	○	●
Dark-tinted rear window		●
Body-colour door handles, door mirrors and side-protection mouldings		●
Rear parking distance sensor	○	○
Increased ground clearance with sump guard for bad road usage	○	
Tow bar with seven-pin electrics	○	○
Two-coat metallic or pearlescent paint	○	●
Special paint (restrictions apply-please consult your retailer for details)	○	

## Option packs

Features	Club	Sportive
<b>Intelligence pack</b>		
• Multi-function trip computer • Rain-sensitive windscreen wipers • Electro-chromatic anti-dazzle rear-view mirror • Automatic Lighting Control (ALC)	○	○
<b>Winter pack</b>		
• Heated seats • Headlight washers • Front fog lights	○	○
<b>Interior pack</b>		
• Cigar lighter and ashtray • 12-volt electrical accessory socket in load area	○	○

## Engines

	1.4i 16v Twinport ECOTEC-4	1.3CDTi 16v ECOTEC-4	1.7CDTi 16v ECOTEC-4	1.9CDTi ECOTEC-4
Fuel type	Petrol	Diesel	Diesel	Diesel
Capacity	1364cc	1248cc	1686cc	1910cc
Maximum power	90PS (66kW) @ 5600rpm	90PS (66kW) @ 4000rpm	100PS (74kW) @ 4400rpm	120PS (88kW) @ 3500rpm
Maximum torque	125Nm (92 lb.ft.) @ 4000rpm	200Nm (147 lb.ft.) @ 1750 - 2500rpm	240Nm (177 lb.ft.) @ 2300rpm	280Nm (206 lb.ft.) @ 2000 - 2750rpm
Layout	4 cylinders, 4 valves per cylinder, double overhead camshafts			4 cylinders, 2 valves per cylinder, single overhead camshaft
Emission compliance	Euro 4			
Fuel/induction system	Naturally aspirated with vacuum-controlled Twinport inlet ports		Turbocharger and common rail fuel injection	
Service interval	20,000 miles or one year (whichever occurs sooner)			

## Transmission ratios

Manual	Gear ratios (mph/1000rpm)						Final drive ratio
	1	2	3	4	5	6	
1.4i 16v	3.73:1 (4.7)	2.14:1 (8.2)	1.41:1 (12.4)	1.12:1 (15.6)	0.89:1 (19.6)	-	4.18:1
1.3CDTi 16v Club	4.27:1 (4.6)	2.16:1 (9.1)	1.30:1 (15.1)	0.96:1 (20.4)	0.74:1 (26.5)	0.61:1 (32.2)	3.72:1
1.3CDTi 16v Sportive	4.27:1 (4.5)	2.16:1 (8.9)	1.30:1 (14.9)	0.96:1 (20.1)	0.74:1 (26.1)	0.61:1 (31.7)	3.72:1
1.7CDTi 16v Club	3.82:1 (5.2)	2.05:1 (9.8)	1.30:1 (15.4)	0.96:1 (20.8)	0.74:1 (27.0)	0.61:1 (32.8)	3.65:1
1.7CDTi 16v Sportive	3.82:1 (5.1)	2.05:1 (9.6)	1.30:1 (15.1)	0.96:1 (20.5)	0.74:1 (26.6)	0.61:1 (32.3)	3.65:1
1.9CDTi	3.82:1 (5.1)	2.05:1 (9.6)	1.30:1 (15.1)	0.96:1 (20.5)	0.74:1 (26.6)	0.61:1 (32.3)	3.65:1
<b>Automatic</b>							
1.9CDTi	4.15:1 (5.6)	2.37:1 (9.8)	1.56:1 (14.9)	1.15:1 (20.3)	0.86:1 (27.1)	0.69:1 (33.8)	3.08:1

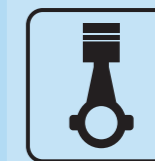

### 90PS/100PS/120PS

Choice of common rail turbo diesel engines

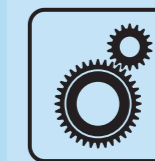

### 6-Speed

Six-speed manual and automatic transmissions available (Diesel models)

● = Standard equipment.  
○ = Optional at extra cost.  
□ = Only available as part of an option pack  
N/C = No-cost option.



Six-speed manual gearbox.

### Vauxhall Assistance and warranties\*

Every New Astravan comes with:

- A one-year unlimited mileage manufacturer's warranty
- Second and third year no-fee customer option warranty up to 60,000 miles (from date of first registration)
- Vauxhall Assistance for 12 months from first registration
- Six-year body panel anti-perforation warranty

\* = Warranty is only available on vehicles sourced from Vauxhall Motors Ltd. Terms and conditions apply – please see your Vauxhall Commercial Vehicle retailer for details.

### Transmissions

- Front-wheel drive
- Five-speed manual gearbox – Standard on 1.4i 16v models
- Six-speed manual gearbox – Standard on 1.3CDTi/1.7CDTi/1.9CDTi models
- Six-speed automatic transmission with Active Select function – available at extra cost on 1.9CDTi models. Electronically controlled with adaptive driving function and winter mode.

### Steering

- Electro-hydraulic power-assisted
- Turning circle: Kerb-to-kerb – 11.10m (36.4ft.)

### Suspension

**Front:** Independent. MacPherson struts with gas-pressure dampers and coil springs. Anti-roll bar. Hydro-formed subframe offers increased lateral stiffness. Hydraulic control arm bushing to give improved insulation from road noise.

**Rear:** Lightweight torsion beam rear axle with one piece, hollow cast trailing arms. Built-in anti-roll bar. Progressive-rate double conical miniblock springs and gas-pressure dampers.

### Brakes

- Anti-lock Braking System (ABS) with Electronic Brakeforce Distribution (EBD)
  - Emergency Brake Assist (EBA) – Emergency brake assist detects the urgency with which the brake pedal is pressed and rapidly increases the pressure to the maximum the system can provide, shortening stopping distances. It also enhances pedal feel. EBA is standard on all Astravan models.
  - Dual circuit, diagonally split braking system
  - Front brake pad wear warning
- 1.4i 16v/1.3CDTi 16v/1.7CDTi 16v**  
Front ventilated discs: 280mm diameter  
Rear discs: 264mm diameter
- 1.9CDTi**  
Front ventilated discs: 308mm diameter  
Rear discs: 264mm diameter

### Electrics

**Alternator:**  
1.4i 16v – 100A.  
1.3CDTi 16v – 70A.  
1.7CDTi 16v – 100A.  
1.9CDTi – 100A.

**Maintenance-free battery:**  
All models – 60Ah.

### Body

- Extensive anti-corrosion protection
- Aerodynamic drag co-efficient: Cd 0.31
- Front and rear safety deformation zones
- Polypropylene front and rear bumpers capable of withstanding minor impacts up to 2.5mph without permanent deformation
- Replaceable protective bumper inserts
- Flush-fitting front and rear screens
- Burst-proof door locks
- Galvanised bodyshell
- Anti-corrosion wax pumped into sills and other underbody cavities
- All weld seams and joints sealed with special compound
- Hem flanges of bonnet, doors and tailgate bonded and sealed
- Abrasion-resistant coating applied to wheel arches and other underbody areas
- Flanged wheel arch edging to prevent build up of dirt
- Paint finish applied electrostatically

### Fuel tank capacity

52 litres (11.4 gallons).

### Insurance group

All models (excluding Sportive 1.9CDTi automatic) – Group 2E T2.  
Sportive 1.9CDTi automatic – Group 3E T2.

As recommended by the Association of British Insurers.

### Dimensions millimetres (inches)

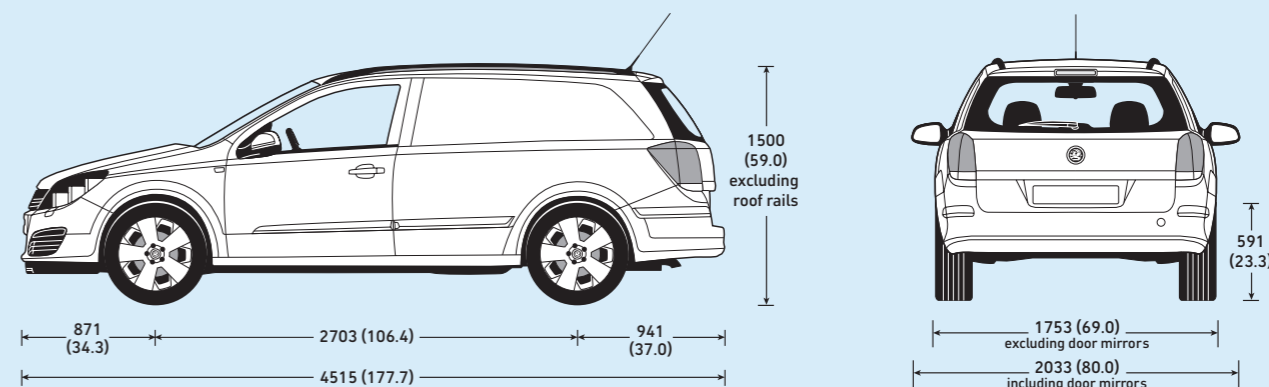

All heights are shown unladen.

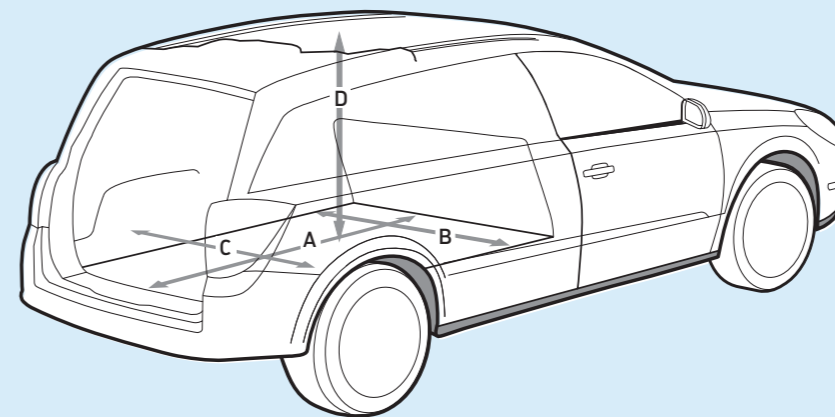

### Loadspace dimensions

Max. load length	mm (inches)
Standard vehicle (A)	1825 (71.8)
With optional Flex bulkhead	2680 (105.5)
Max. load width	
Standard vehicle (B)	1376 (54.2)
Between wheel arches (C)	1103 (43.4)
Max. load height	
Standard vehicle (D)	900 (35.4)
Access dimensions	
Tailgate aperture height	766 (30.1)
Tailgate aperture width	1024 (40.3)
Flex bulkhead aperture width	531 (20.9)
Flex bulkhead aperture height	276 (10.9)

### Loadspace volume

VDA method	cu.m (cu.ft)
All models	1.58 (55.8)

## Weights and towing data

Model	UK plated weights and kerbweights kg				Total GVW	Payload kg	Towing weights Trailer with brakes (without brakes) kg	Plated Gross Combination Weights (GCW) kg	
	Front axle Plated	Kerb	Rear axle Plated	Kerb					
<b>Club</b>									
1.4i 16v Twinport	885	694	940	466	1810	1160	650	900 (610)	2710
1.4i 16v Twinport (a/c)	900	709	940	466	1825	1175	650	900 (610)	2725
<b>1.3CDTi 16v</b>									
1.3CDTi 16v	975	794	940	466	1905	1260	645	1300 (660)	3205
1.3CDTi 16v (a/c)	990	809	940	466	1920	1275	645	1295 (660)	3215
<b>1.7CDTi 16v</b>									
1.7CDTi 16v	1010	826	940	464	1935	1290	645	1400 (675)	3335
1.7CDTi 16v (a/c)	1025	841	940	464	1950	1305	645	1400 (675)	3350
<b>1.9CDTi</b>									
1.9CDTi	1030	846	940	464	1960	1310	650	1400 (685)	3360
1.9CDTi (a/c)	1045	861	940	464	1975	1325	650	1400 (685)	3375
1.9CDTi automatic	1060	876	940	469	1990	1345	645	1400 (685)	3390
1.9CDTi automatic (a/c)	1075	891	940	469	1995	1360	635	1400 (685)	3395
<b>Sportive</b>									
1.3CDTi 16v	990	811	940	467	1920	1278	642	1295 (660)	3215
1.7CDTi 16v	1025	843	940	465	1950	1308	642	1400 (675)	3350
<b>1.9CDTi</b>									
1.9CDTi	1045	863	940	465	1975	1328	647	1400 (685)	3375
1.9CDTi automatic	1075	893	940	470	1995	1363	632	1400 (685)	3395

a/c = Air-conditioning.  
**Note: Kerbweights** for standard vehicles include coolant, oil, 90% full fuel tank and spare wheel. They will vary according to the vehicle specification (including options and accessories) with a corresponding variation in payload. **Payload** figures do not allow for the weight of the driver, or any passengers, which should therefore be deducted from the figures shown and are also subject to correct weight distribution. **Gross plated weights** (including axle weights) quoted on the vehicle plate must never be exceeded. **Roof load** should not exceed 100kg including the weight of the roof rack/carrier.



### Payload

632kg-650kg

## Glossary of terms

### Plated weight

The maximum weight to which a vehicle or an axle may be loaded, determined either by the design of the components or by legislation. All commercial vehicles must carry a manufacturer's 'plate' showing the vehicle and axle gross 'plated weights'. It is an offence to drive a vehicle in a condition where any of these weights are exceeded.

### Kerbweight

The weight of the complete vehicle in standard form, excluding payload and driver but including coolant, oil, 90% full fuel tank and spare wheel where appropriate. Kerbweights quoted in Vauxhall brochures are subject to manufacturing tolerances and to the fitment of optional equipment and accessories. Where load capacity is critical the actual kerbweight should be obtained by weighing the vehicle on a calibrated public weighbridge.

### Gross Vehicle Weight (GVW)

The total permissible weight of a vehicle including payload and passengers, as shown on the manufacturer's plate.

### Gross Combination Weight (GCW)

The maximum permissible weight of a vehicle, including payload and passengers, combined with the total weight of any trailer it is towing. The maximum GCW weight limit is quoted on the vehicle plate and must not be exceeded.

### Payload

The total permissible weight that can be carried without exceeding the vehicle's plated weight. This can be obtained by deducting the kerbweight from the plated Gross Vehicle Weight (GVW). Please note: the payload figure does not allow for the weight of the driver or any passengers which should therefore be deducted from the figures shown and are also subject to correct weight distribution.

### Maximum towing weight

The maximum weight of any trailer and its load which may be towed within the limit of the vehicle's plated Gross Combination Weight (GCW). It is based on the ability of the vehicle - at full GCW - to restart on a 12% gradient, which is approximately 1 in 8.3, at sea level. At altitudes above 1500 metres, the engine output may drop with a corresponding reduction in towing capability. It is the operator's responsibility to ensure that the trailer noseweight does not cause the rear axle plated weight of the towing vehicle to be exceeded.

*Always fit Vauxhall towing attachments and accessories available from your Vauxhall Commercial Vehicle retailer. They are designed specifically for Vauxhall models and carry a 12-month warranty.*

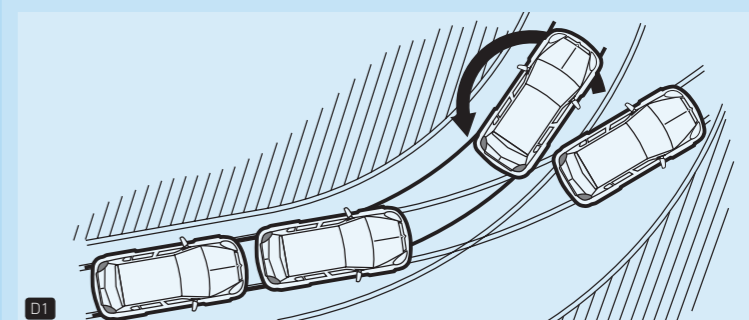

### D1. Electronic Stability Programme-plus (ESP-plus)

Offers further benefits over conventional ESP systems. The system works in conjunction with the vehicle's traction control set-up, sensing when the vehicle is about to slide on a bend and applying corrective braking to the appropriate wheel or (up to four) wheels, correcting the slide and helping you regain control more rapidly (with conventional ESP systems the braking force is applied at only one wheel). The system is standard on 1.9CDTi and available as a low-cost option on all other models.