

Trust Vauxhall

Protecting the environment

Vauxhall's commitment to the environment is demonstrated by our products' many environmental awards, won both through the use of more recycled materials and by becoming cleaner and more efficient. For information on Vauxhall's efforts to achieve an environmentally sustainable future, see www.vauxhall.co.uk/recycling.

Fleet Customer Services

Our dedicated support services for fleet managers includes factory demonstrators, a three-day test drive programme and information on whole life costs, company car taxation and finance. For further information please call **0870 010 0651**.

Buying your car

GMAC offers one of the most comprehensive and competitive ranges of financing plans in the UK. Contact your local Vauxhall retailer for details or call the GMAC customer service centre on **0845 712 3444**.

Sureguard protection

Sureguard Assistance offers the benefits of Vauxhall Assistance for three years from first registration, while Sureguard Warranty also provides a parts and labour warranty for high-mileage or long-term owners. For details contact your local Vauxhall retailer or call **0870 752 7020**.

Specialist Mobility advice

Motability accredited Vauxhall retailers can provide special mobility help and advice. Blue badge holders are entitled to very favourable discounts on new vehicles. Contact your local Motability accredited Vauxhall retailer or **Freefone 0800 731 5267**.

Servicing and maintenance

The best way to maximise the performance and reliability of your Vauxhall is to have all routine servicing and maintenance carried out at one of around 400 Vauxhall retailers. To find your nearest retailer call **0845 600 1500**.

In the event of an accident...

Vauxhall Accident Support helps keep you mobile following an accident. Benefits include scene-of-accident advice, message service, assistance with claims and vehicle recovery. Call **0800 010 304** for a free driver's pack.

Vauxhall Insurance

Available for new and used Vauxhalls, a Vauxhall Insurance policy offers a unique package designed specifically for Vauxhall drivers. For a highly competitive quotation, call **0870 024 0240** or visit our website at www.vauxhall.co.uk.

For more information...

For a brochure on any Vauxhall model (up to a maximum of three per caller) or location of your nearest Vauxhall retailer please **Lo-call 0845 600 1500**.

Alternatively, details can be found on our website at www.vauxhall.co.uk

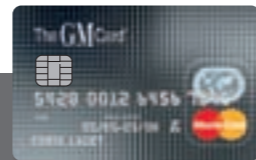

- Save up to £2000* on a new Vauxhall with The GM Card

- 100 Rebate Points worth £100 when you use The GM Card for the first time

- Rebate Point saving is on top of any discount or offer negotiated with the Retailer

- Earn 3 Rebate Points (£3) for every £100 you spend

Typical 14.9% APR variable

To apply call **0845 746 2777** or visit www.gmcard.co.uk

For a copy of this brochure in large print, Braille or on audio tape, please call **0845 600 1500**, or via our textphone service on **18001 08456 785 785**.

The GM Platinum Card is issued by HFC Bank Limited and is available to persons aged 18 years or over and resident in the UK (or 21 and over in the Channel Islands) and is subject to status and conditions. Written quotations are available upon request from The GM Platinum Card, PO Box 3615, Birmingham B3 2RJ. The typical APR quoted is the rate for new customers. *Rebate Points are earned on purchases using The GM Platinum Card. Rebate Points are not earned on Balance Transfers or Cash Advances. You earn money off a new Vauxhall/Saab by accumulating Rebate Points under the Rebate Points Programme. Vauxhall Motors Ltd is solely responsible for the operation of the Rebate Points Programme, which is subject to the Rebate Points Programme Rules. You can redeem up to 2500 Rebate Points subject to the Model Line Maximum which will vary in amount in relation to different Vauxhall/Saab vehicle model lines and unlimited Partner Points. Rebate Points and unlimited Partner Points are redeemable as discounts on a new Vauxhall/Saab vehicle and must be redeemed four years from the issue date. Rebate Points may not be redeemed by Motability Contract Hire customers. The GM Card is a trading name and style of both HFC Bank Limited and Vauxhall Motors Ltd. HFC Bank registered in England No. 1117305. Registered Office: North Street, Winkfield, Windsor Berkshire SL4 4TD is authorised and regulated by the Financial Services Authority. Member HSBC Group. HFC Bank Limited is not a member of the same group of companies as Vauxhall Motors Ltd, Saab GB Limited or GMAC (UK) plc. Vauxhall Motors Ltd, Registered Office: Griffin House, Osborne Road, Luton, Bedfordshire LU1 3YT. Registered in England number 135767. - CN6/0987.

Every effort has been made to ensure that the contents of this publication were accurate and up-to-date at the time of going to press (January 2007). Vauxhall vehicles are equipped with components manufactured by various General Motors operating units and outside suppliers. The Company reserves the right to alter specifications and withdraw products from sale without notice. Any such alterations will be notified to Vauxhall retailers at the earliest opportunity; please consult your local retailer for the latest information. The specifications detailed within this brochure are not necessarily applicable to alternative models such as Special Editions. Details of any such models will be contained in specific literature or found on the Vauxhall website. Please note that Vauxhall retailers are not the agents of Vauxhall Motors Limited and are not authorised to bind the Company by any specific or implied undertaking or representation. It is advisable to ensure that your motor insurance policy provides adequate cover for additional fitted options and accessories. As part of Vauxhall's policy of environmental care, this brochure is printed on paper manufactured using Elemental Chlorine Free pulps from specially farmed, sustainable timber resources. All rights reserved. No part of this publication may be reproduced in any form or by any means, without the prior written permission of Vauxhall Motors Limited.

VM0606818 Published February 2007. Amended June 2007 (BMB/Graymatter) Vauxhall Motors Limited, Luton LU1 3YT



Astra TwinTop

Fall in love with driving again



NEVER STOP... MOVING

Because your heart says convertible. And your head says coupé.
Astra TwinTop. Fall in love with driving again.



Announcing its New Car Honours awards for 2006, Auto Express claimed that Astra TwinTop's "stunning looks and impressive specifications earn it the nod as Best Convertible".

This brochure covers Astra TwinTop, TwinTop Sport and TwinTop Design models only. Some of the vehicles shown in this brochure include options and accessories available at extra cost. And not all of the features described are available on every model. So please check the Equipment section for further details. From time to time, we also offer alternative Astra TwinTop models such as Special Editions which are featured in separate literature or can be found on the website www.vauxhall.co.uk

- Roof system 10
- Driving dynamics 12
- Powertrain 14
- Safety and security 16
- Features 18
- Model line-up 20
- Vauxhall by Design 24
- Colours and trims 28
- Equipment 32
- Technical data 36



NEVER STOP... **CREATING**

Because the more we get from our cars the more we get out of life.

NEVER STOP... EXPLORING

Because, in Astra TwinTop, there's a great big world out there. And it's all worth seeing.



NEVER STOP... SHARING

Because Astra TwinTop seats four adults – with room for luggage too.





▲ Easy load. At 205 litres, TwinTop already boasts an impressive roof-down luggage space, but its exclusive – and very smart – Easy Load function helps you load and unload your luggage more easily. When you push the button, the folded roof section rises by around 25cm, providing easier access to the load area.



▲ Windbreak. We probably don't need to convince you of the benefits of convertible motoring, but what if we could make the experience even better? The TwinTop windbreak helps you enjoy the fresh air without unpleasant draughts. It's standard on TwinTop Design and optional on all other models.

▶ Innovative roof system. The Astra TwinTop roof is brilliantly engineered – three sections, five electric motors, eight hydraulic cylinders and 14 articulated joints. Why? Because we wanted it to look great, and maximise your luggage space too – something else we've achieved with spectacular success. This is clearly not your ordinary steel roof. It's fully automatic, for a start, with no additional clips to release or fasten. Just hold the button, then sit back and relax. Opening and closing safely and securely takes less than 30 seconds. And the system even works on the move at low speeds – up to 18mph to be precise.



▶ Generous seating and luggage space. Talk about having your cake and eating it. The clever folding roof design, coupled with careful shaping of the seat cushions and bolsters, gives enough legroom and shoulder space for two adult rear seat passengers. It also allows you to travel with bags of luggage. With the roof down, Astra TwinTop offers an excellent 205 litres of luggage space. And as a coupé, it boasts a luggage compartment volume of 440 litres. That's even more than the Astra five-door hatchback. And that's not all. There's additional storage space in two compartments in the side panel of the boot. And the handy rear seat load-through facility helps you make room for long items.

▶ Remote control roof operation. Every Astra TwinTop model features remote control for the central deadlocking and ultrasonic security alarm. But on Sport and Design models, the car key can also open and close the TwinTop roof – again by remote control. Go on, impress your friends.



Never stop... thinking

Because really clever technology makes the simple things in life even easier. Sunny morning. Rainy afternoon. No need to worry. Astra TwinTop combines coupé security and refinement with all the fresh air and freedom you'd expect from one of the best looking four-seat, four-season convertibles around. And it's all thanks to an ingenious, three-piece folding steel roof.

Never stop... enjoying

Because once you start, you'll want the road to go on forever. Great to drive. Great to be driven in. TwinTop's dynamic Astra chassis strikes a careful balance between ride comfort and sure-footed agility. But there's another element – a high level of responsibility. Vauxhall's continuous development of ever smarter active safety features makes it a safer car to drive too.



▶ **ESP-Plus with Traction Control.** Whether it's a wet roundabout or a greasy road, one day you might meet a slippery surface that catches you out. That's the day you'll be glad of TwinTop's latest generation Electronic Stability Programme with Traction Control. Sensing if the car starts to slide, ESP-Plus quickly applies corrective braking to the appropriate wheels to help you regain control during adverse or emergency conditions. Traction Control (TC) reduces wheelspin during acceleration. Both features now are available – standard or as an extra cost option – across the whole TwinTop range.

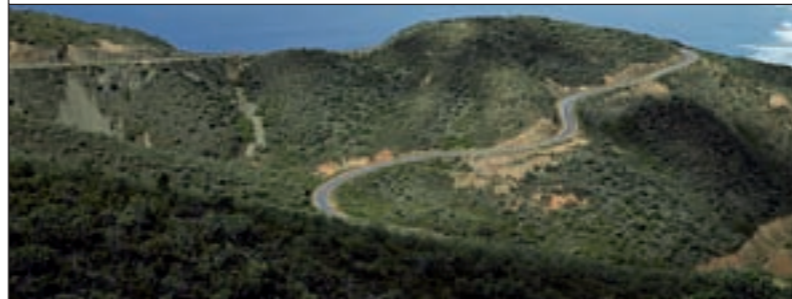

Intelligent ABS. Most people appreciate the benefits of Anti-lock Braking System (ABS) and four-wheel disc brakes, but Astra TwinTop takes things even further. Cornering Brake Control, Electronic Brakeforce Distribution and Emergency Brake Assist make the car even easier to control and stop in emergency cornering and braking conditions and more effective when it does so. Further explanation can be found in the Technical data section on page 39.

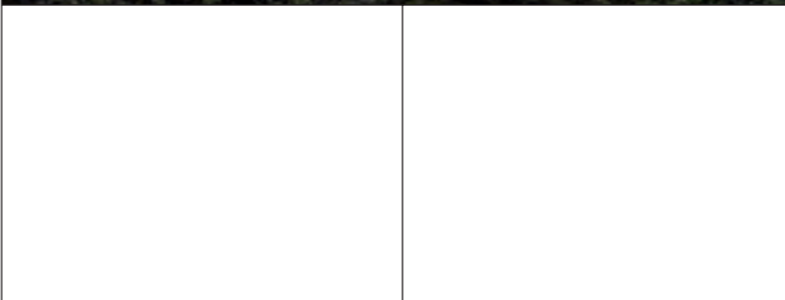

◀ **Steering.** TwinTop's Electro-Hydraulic Power Steering (EHPS) is smart in so many ways. It's electrically powered, so promotes even greater fuel economy. And it's speed-sensitive too – light at low speeds for easy parking, and progressively smoother and more precise as you speed up.

▶ **Specially tuned suspension.** Every TwinTop features specially tuned suspension with gas-pressure dampers for taut road holding and a controlled ride. Cornering is neutral and agile, steering response precise and stability improved during emergency manoeuvres.



▶ **Sport switch.** Providing performance to suit your mood, the Sport switch is like having two cars in one, each with its own unique character and instant switching between the two. Push the button for quicker throttle response and sharper steering, plus sportier gearchanges on automatic models.





▶ ▶ **Transmissions.** Choose the 2.0i 16v Turbo or 1.9CDTi engine and it'll come with a six-speed manual gearbox. All other models feature a five-speed manual as standard, with a four-speed automatic – with adaptive driving function and Winter mode – also available on 1.8i 16v VVT models.



▼ **1.8i 16v VVT and new 1.6i 16v VVT.** Astra TwinTop's two naturally aspirated petrol engines use Variable Valve Timing, allowing them to provide most of the maximum torque across a wide rev band. The result? Incredible flexibility through the gears, high power and low fuel consumption. The 140PS 1.8i 16v VVT is now joined by a new 1.6 litre version which provides more power (115PS) and torque (155Nm) than the unit it replaces.



2.0i 16v Turbo. Available on TwinTop Design models only, the range-topping 2.0 litre petrol engine, with turbo-charger and intercooler, packs a genuine 200PS and 262Nm max torque. Yet a high level of flexibility ensures it's equally at ease in traffic as it is at motorway speeds.

▶ **1.9CDTi.** The hot ticket in diesel engines is common-rail fuel injection. And that's exactly what you get with TwinTop's sporty 150PS turbo diesel. Producing high levels of torque at low speeds – 320Nm at just 2000rpm – combining superior flexibility and performance with outstanding economy.



Never stop... driving

Because the more you drive it, the more you'll love it. Whether you're searching for the perfect driving experience or not, you still need an engine with strong response, high flexibility and plenty of fuel economy too. Petrol or diesel, TwinTop's advanced engine technology helps make every trip a pleasure. Easy to drive. And easy on the pocket too.

Never stop... protecting

Because feeling safe behind the wheel is yet another reason why Astra TwinTop feels so good to drive. Astra TwinTop protects you in so many ways. And it's not just the obvious features like airbags and rollover protection. The Astra chassis is engineered to help prevent accidents in the first place. And our security features look after your belongings as carefully as our safety features look after you.



Airbags. Astra TwinTop features a full complement of passive safety measures, including driver's and front passenger's airbags and extensive side-impact protection too. Our improved side-impact airbags feature an enlarged 'Thorax-Pelvis' design to protect your lower and upper body in the event of an impact. And all models have our patented pedal release system and front body-lock seatbelt pretensioners.



Active rollover protection system. It's not exactly something you can leave to chance in a convertible, so it won't come as any surprise to hear that the TwinTop body and chassis are specially reinforced – an additional cross-member in the floor plus high-strength steel tubes in the A-pillars are just two examples. And that's not all. TwinTop and TwinTop Sport models feature rigid rollover protection hoops, while Design models feature a pop-up rollover protection system (below). If the car enters an uncontrolled state that could result in it rolling over, a sensor activates two high-strength aluminium rollover hoops, located behind the two rear seats, that pop up and lock into position – all in a fraction of a second.

Adaptive Forward Lighting (AFL). Want to see round corners? With optional bi-xenon Adaptive Forward Lighting, the headlight beam moves up to 15 degrees in the direction you turn the steering wheel to light up where you're heading. Above 65mph, it raises the dipped headlight beam slightly, extending the range of vision for increased safety – then automatically returns the beam to its normal position when you fall below that speed. As *Autocar* magazine said: "AFL is easy to get used to and hugely improves visibility for night driving". This advanced option comes with dynamic beam levelling, high-pressure headlight washers and dark-style headlights.

ISOFIX. TwinTop rear seats are pre-fitted with rigid ISOFIX child seat fastening brackets, virtually eliminating the dangers of incorrect child seat installation. For maximum safety, you simply click a compatible Vauxhall ISOFIX accessory child seat into the mounting points engineered in the car.

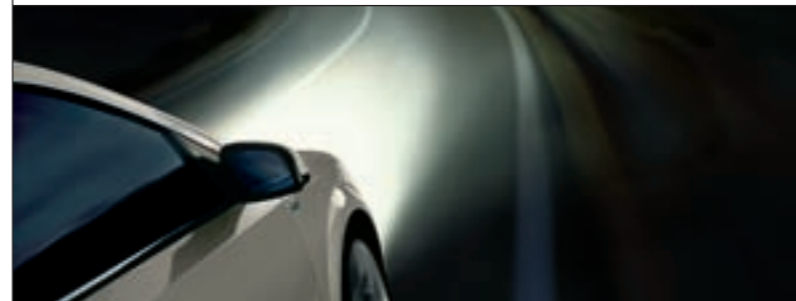

Security. Remote control central deadlocking, an electronic engine deadlock immobiliser and an ultrasonic security alarm are all standard. And our clever door-to-door illumination feature keeps the dipped headlights and rear lights on for 30 seconds to light your way from a garage or car park.

▶ **Air-conditioning.** The benefits of air-conditioning need little introduction to Vauxhall owners. From chilled air on hot days to faster demisting on damp days, it makes for a fresher interior all year round and is standard on every Astra TwinTop.



▶ **Satellite navigation.** The optional CD 70 audio system is one of the cleverest Sat Nav systems around, guiding you to your destination with audible direction guidance and route display via the split-screen colour monitor. You can even enter your destination via the on-screen map.



▶ **Style and space.** The four-seat Astra TwinTop interior is just as unique and dynamic as it is on the outside, with exclusive trim detailing and carefully co-ordinated fabric and leather trim choices. The stylish facia makes the switchgear and instruments both easy to reach and easy on the eye.

▶ **Smart features.** Every TwinTop model features a clever overhead lighting console, just above the rear view mirror. It houses the security alarm sensors and the roof operation switch. Choose TwinTop Design and your driver environment is packed with clever ideas, all aimed at keeping your attention on the road ahead. Activate the rain-sensitive wipers and they'll switch themselves on automatically when it rains. Automatic lighting control does the same for the headlights when it starts to get dark. And the electro-chromatic rear-view mirror dips automatically to reduce any glare from the headlights on the car behind.



▶ **Big sounds.** If in-car audio is your thing, look no further. Astra TwinTop systems are available with all the latest technologies. The double-DIN facia format makes every system easier to operate. A remote display and steering wheel audio controls are standard across the range. And the standard CD 30 MP3 stereo radio/CD player can play MP3 tracks from CD. Optional systems include satellite navigation and fully integrated mobile phone connectivity, with both voice activation and Bluetooth® wireless technology.



▶ **Seat comfort.** Astra TwinTop drivers are individuals in every sense. So every model has reach and rake adjustable steering. All front seats are height adjustable. And the Sports seats, available as part of the optional Leather Pack, feature additional lateral support.



Never stop... relaxing

Because modern life's so hectic, you can't have enough places to call home. The more at home you feel in your car, the more you enjoy your drive, and the easier it is to focus on the job in hand. So the Astra TwinTop interior space is light and comfortable. And it's easy to find the perfect seating position, the right interior temperature and your favourite audio choice.

TWINTOP

With TwinTop, you don't trade a retractable roof for other features. This model packs a lot more than you might expect.

Standard features include:

- Remote control central deadlocking
- Remote control ultrasonic alarm system
- CD 30 MP3 stereo radio/CD player with MP3 capability
- Steering wheel mounted audio controls
- Door-to-door illumination
- Air-conditioning
- Steering column adjustable for reach and rake
- Leather-covered steering wheel
- Height-adjustable front seats
- Electrically operated windows
- Electrically adjustable/heated door mirrors
- 16-inch Structure wheels with 205/55 R 16 ultra-low profile tyres
- Four airbags
- Anti-lock Braking System

Engine availability and insurance group (ABI)

1.6i 16v VVT	8E
1.8i 16v VVT	10E
1.8i 16v VVT automatic	10E
1.9CDTi 16v	12E

Star Silver two-coat metallic paint is optional at extra cost.

**TWINTOP SPORT**

TwinTop Sport comes with more cool features, including remote control roof operation, and a wider colour choice too.

Standard features include:

- Remote control central deadlocking
- Remote control ultrasonic alarm system
- CD 30 MP3 stereo radio/CD player with MP3 capability
- Air-conditioning
- Leather-covered steering wheel
- Height-adjustable front seats
- Electrically operated windows
- Electrically adjustable/heated door mirrors
- Four airbags
- Anti-lock Braking System

Additional features over and above TwinTop models:

- 16-inch Twin Spoke alloy wheels with 205/55 R 16 ultra-low profile tyres
- Front fog lights
- Trip computer with graphic information display
- Remote control roof operation

Engine availability and insurance group (ABI)

1.6i 16v VVT	8E
1.8i 16v VVT	10E
1.8i 16v VVT automatic	10E
1.9CDTi 16v	12E

Plus Pack and Black Sapphire two-coat pearlescent paint are optional at extra cost.

**Optional TwinTop Sport Plus Pack**

- Cruise control
- 17-inch five-spoke alloy wheels with 225/45 R 17 ultra-low profile tyres

TWINTOP DESIGN

Astra TwinTop Design. Move up to a model that puts the accent on modern luxury, maximum style and serious equipment.

Standard features include:

- Remote control central deadlocking
- Remote control ultrasonic alarm system
- Air-conditioning
- Height-adjustable front seats
- Electrically operated windows
- Electrically adjustable/heated door mirrors
- Front fog lights
- Four airbags
- Anti-lock Braking System

Additional features over and above Sport models:

- 17-inch ten-spoke alloy wheels with 225/45 R 17 ultra-low profile tyres
- Electronic Stability Programme-plus
- Sport switch
- Silver Alpha cloth/Morrocana seat trim
- Leather-covered sports steering wheel
- Rain-sensitive windscreen wipers
- Electro-chromatic anti-dazzle rear-view mirror
- Automatic lighting control
- Pop-up rollover bar protection system
- Height-adjustable rear seat head restraints
- Windbreak
- Chrome-effect sports exhaust tailpipe

Leather Pack and Star Silver two-coat metallic paint are optional at extra cost.

**Engine availability and insurance group (ABI)**

1.8i 16v VVT	10E
1.8i 16v VVT automatic	10E
2.0i 16v Turbo	16E
1.9CDTi 16v	12E

Optional TwinTop Design Plus Pack

- Cruise control (above right)
- 18-inch 11-spoke alloy wheels with 225/40 R 18 ultra-low profile tyres (above left)

Optional TwinTop Design Premium Pack

- Cruise control (above)
- 18-inch 11-spoke alloy wheels with 225/40 R 18 ultra-low profile tyres (above far left)
- CD 70 stereo radio/CD with MP3 capability/satellite navigation with colour monitor



Vauxhall by Design

Vauxhall by Design is all about choice – selecting your new car, then personalising it to suit yourself with a choice of individual options, special option packs and accessories available at highly attractive prices. You'll find further information on the following pages. Ask your Vauxhall retailer for more details.



Developed in conjunction with auto design specialists Irmscher International, Astra TwinTop styling accessories perfectly complement the vehicle's lines, as well as being manufactured to the same exacting standards as the car itself.



◀ ▼ **Irmscher styling.** For great looks, Irmscher styling accessories are available in special Styling Packs or individually. Vehicle illustrated left features body-colour cross hatch grille with aluminium upper and laser-etched 'Irmscher' badge, stainless steel door handle covers, aluminium-effect fuel flap cover, front lower skirt extensions, side sills and 19-inch GT-star 'titanium-effect' alloy wheels. A body-colour rear wing spoiler, illustrated below, is also available.



▶ **Irmscher alloy wheels.** They're the perfect way to personalise your Astra TwinTop. With a huge range to choose from (style illustrated right is Stila), and sizes from 16 to 19 inches, you're sure to find one to suit your style and budget. And don't forget to ask about our accessory wheel locking kits too.



▲ **Bicycle carrier.** TwinTop may have one of the cleverest roof systems around, but don't let that stop you taking your bike along too. This tow bar mounted carrier takes two bicycles, comes with separate rear lights (excludes number plate) and allows full roof operation.

▼ **Blaupunkt Casablanca*** Not just a high-end MP3/WMA tuner with FM/AM/RDS, but great design, and multiple connectivity options.

*Additional fitting parts are required. Please check with your retailer for details.



Vauxhall accessories are the right choice for your Astra TwinTop. Whatever you're into, there's certain to be a Vauxhall accessory with your name on it. Available individually or in special packs, we've only featured a small selection here. The Vauxhall Car Accessory brochure and Car and Accessory Price Guide give further details. Or check out our website at www.vauxhall-accessories.com

Child seats.* Vauxhall offers a range of child seats, ergonomically styled for comfort and safety. The Baby-safe (for babies from birth to 13kg), and Kid (15-36kgs) seats are fixed with a standard lap and diagonal seatbelt, while the Duo ISOFIX (9-18kg) can also be attached using the ISOFIX child seat restraint fittings, which are standard on the rear seats of all TwinTop models. The rigid ISOFIX anchoring mechanism virtually eliminates the dangers of incorrect child seat installation.

*Vauxhall child seats are suitable for the rear seats only.

Protection Plus Pack.

- Paint and trim protection
- Velour mats



Travel Pack.

- First aid kit
- Warning triangle
- Spare bulb kit (not for AFL headlights)
- Fire extinguisher
- Hi-visibility vest



Protection Pack.

- Velour mats
- Windbreak (shown on page 27)



Astra TwinTop options can make life better in so many ways. They're available individually – a windbreak, satellite navigation and cruise control are just three examples – and in special option packs at great prices. For further information please ask your Vauxhall retailer.

Leather Pack. For the ultimate in TwinTop Design interior trim, choose the optional Leather Pack. It comprises leather seat facings, electrically heated sports front seats (with tilt and lumbar adjustment on driver's side) and comes packaged with indirect door night lighting.



Bluetooth® technology. TwinTop models can now be specified with the latest mobile phone* technology, operated via the car's steering wheel mounted audio controls. Fully integrated into the car's audio system, it has voice activation and Bluetooth® wireless connectivity.

Rear parking sensors. This clever early warning system helps safeguard your car and pedestrians. When reverse gear is selected, the system beeps as you reverse close to an obstruction, rising to a continuous tone when the object is approximately 300mm away.

Individual options include:

- Adaptive Forward Lighting, incorporating dark-style bi-xenon headlights with dynamic beam levelling and high-pressure headlight washers
- Rear parking distance sensor
- Windbreak (right)
- CD 70 stereo radio/CD with MP3 capability/satellite navigation with colour monitor
- Electronic Stability Programme-plus
- Mobile phone system* with Bluetooth® wireless connectivity
- Cruise control

*Contact your retailer for details of phone compatibility.



Great paint colours and exclusive trim choices – including unique Saddle Brown leather.
It's all on view, don't forget. So choose carefully!

Due to the limitations of the printing process the colours reproduced may vary slightly from the actual paint colour or trim material. As a result they should be used as a guide only. Your Vauxhall retailer has a comprehensive display of all our paint samples and trim swatches.



▶ Royal Blue – solid



▶ Power Red – solid



▶ Star Silver – metallic



▶ Black Sapphire – pearlescent



▶ Ultra Blue – pearlescent



▶ Metro Blue – metallic



▶ Air Blue – pearlescent



▶ Digital Green – pearlescent



▶ Panacotta – pearlescent



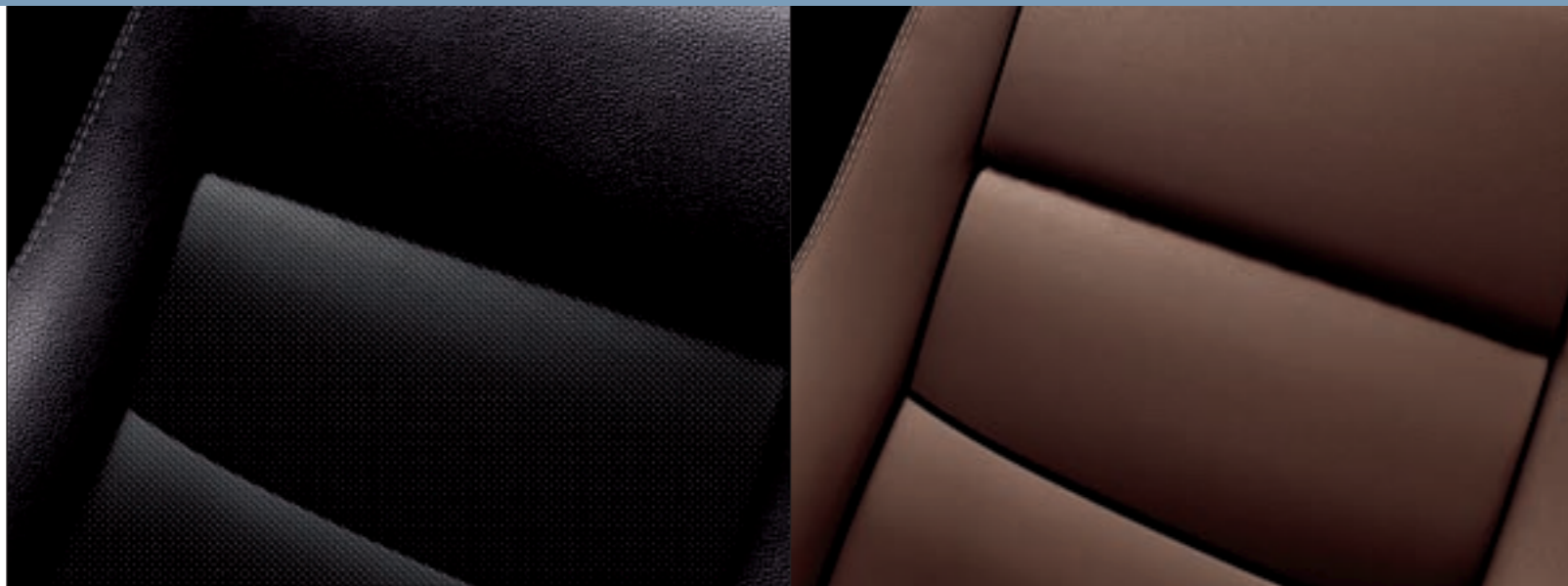

▲ Charcoal Leather

▲ Saddle Brown Leather

▼ Alpha cloth Charcoal

▼ Alpha cloth Red/Charcoal

▼ Silver Alpha cloth/Morrocana

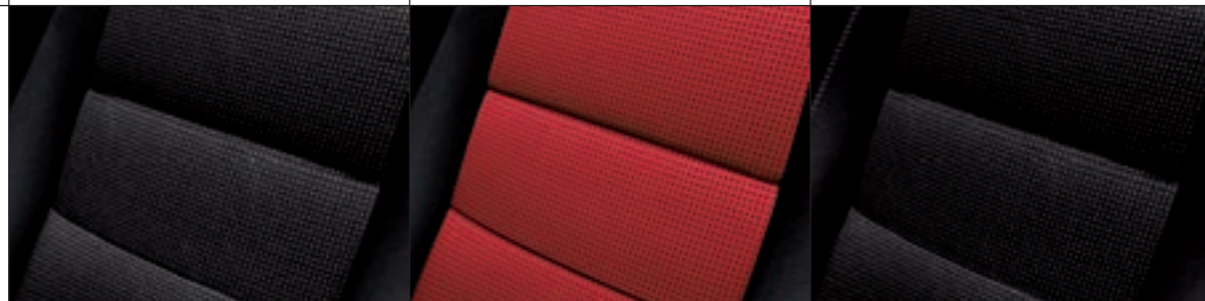

Exterior colours

Model, trim name and trim colour

	TwinTop Alpha cloth	TwinTop Sport Alpha cloth	TwinTop Design Silver Alpha/Morrocana	TwinTop Design Leather*
Solid				
Royal Blue	Charcoal	Charcoal	Charcoal	Charcoal or Saddle Brown
Power Red	Charcoal	Charcoal or Red	Charcoal	Charcoal
Two-coat metallic*				
Star Silver	Charcoal	Charcoal or Red	Charcoal	Charcoal or Saddle Brown
Metro Blue	-	Charcoal	Charcoal	Charcoal or Saddle Brown
Two-coat pearlescent*				
Black Sapphire	Charcoal	Charcoal or Red	Charcoal	Charcoal or Saddle Brown
Ultra Blue	-	Charcoal	Charcoal	Charcoal
Air Blue	-	Charcoal	Charcoal	Charcoal
Digital Green	-	Charcoal	Charcoal	Charcoal
Panacotta	-	Charcoal	Charcoal	Charcoal or Saddle Brown

The exterior colours listed above are only available on those models where an interior trim colour is shown.

* = Optional at extra cost.



Front and side-impact airbags.



Two integral rear rollover protection hoops.



Front map reading lights.

Safety

Standard features: • Driver's airbag • Front passenger's airbag • Front seat side-impact airbags • Energy-absorbing steering column • Pedal release system – Reduces potential injury to the driver's legs and feet during a severe frontal impact • Laminated windscreen • Side-impact protection beams • Integral protective side door padding • Reinforced passenger safety cell

• ISOFIX child seat restraint system for rear seats (does not include child seat) – Secures ISOFIX child safety seats to the vehicle itself, virtually eliminating the dangers that can result from improper installation

• Anti-lock Braking System (ABS) • Electronic Brakeforce Distribution (EBD) – Distributes the braking force between the wheels most able to use it, allowing stable and efficient braking • Cornering Brake Control (CBC) – see **D2** on page 39 • Emergency Brake Assist (EBA) – Increases applied brake force in emergency braking situations • Adaptive Brake Lights (ABL) – If the driver brakes hard enough to activate the ABS the brake lights flash on and off at the rate of four times per second, thus warning following vehicles that heavy braking is in progress

• Height-adjustable front seat head restraints • Pyrotechnic front body-lock seatbelt pretensioner system – Tightens the seatbelt during the early stages of a frontal impact • Front seatbelt force limiters – Reduce potential upper body injuries during a frontal impact • Anti-submarining ramps in all seats – Help prevent occupants sliding underneath the lap belt during a collision

Additional features	TwinTop	Sport	Design
Electronic Stability Programme-plus (ESP-plus) with traction control – see D3 on page 39	○	● ¹	●
Two integral rear rollover protection hoops	●	●	●
Two pop-up rear rollover protection bars			●
Two height-adjustable rear seat head restraints			●

Security

Standard features • Remote control central deadlocking (doors, boot lid, fuel filler flap) • Visible Vehicle Identification Number (VIN) plate • 'Key left in ignition' audible warning • Electronic engine deadlock immobiliser • Electronic theft protection for audio equipment • Locking wheel bolts for alloy wheels (where fitted) • Driver's internal central locking switch • Door-to-door illumination – Keeps the headlights and rear lights on for 30 seconds after the car doors are locked • Folding key • Remote control ultrasonic security alarm system

Facia, instruments and controls

Standard features • Multi-function display showing time, date, audio information and outside air temperature (with ice warning function) • Rev counter • Digital clock with automatic RDS time adjustment • Black instruments with chrome edging • Steering column adjustable for reach and rake • Electronic odometer and trip odometer • Instrument panel light dimmer • Handbrake-on/low brake fluid level and low fuel level warning lights • Service interval monitor

Additional features	TwinTop	Sport	Design
Three-spoke leather-covered steering wheel	●	●	
Three-spoke leather-covered sports steering wheel			●
Multi-function trip computer		●	●
Cruise control	○	○ ²	○ ²

Interior features

Standard features • Sports-style front seats • Driver's and front passenger's seats with reach and recline adjustment • Driver's and front passenger's seat height adjusters • Lockable, split-level glovebox • 12-volt auxiliary power socket within centre console • Chrome-effect internal door handles • Charcoal fleece velour carpet • Fully carpeted luggage area • Illuminated luggage area and glovebox • Front map reading lights integral with courtesy light • Driver's and front passenger's sunvisors with vanity mirrors • Fade up/fade down courtesy lighting operated by door switches • Easy Load boot access system • Rear seat centre armrest with load-through facility

Additional features	TwinTop	Sport	Design
Electro-chromatic anti-dazzle rear-view mirror			●
Leather seat facings (includes heated front seats with variable temperature settings)			□
Sports front seats			□
Satin stone-effect centre console and inserts on facia and doors	●	●	
Matt chrome-effect inserts on facia and doors			●
Piano black-effect centre console			●

Heating and ventilation

Standard features • Interior pollen filter • Air recirculation with activation light • Air blend heater with four-speed fan

Additional features	TwinTop	Sport	Design
Air-conditioning	●	●	●



Rain-sensitive windscreen wipers.



Automatic air-conditioning.

● = Standard equipment.
○ = Optional at extra cost.
□ = Only available as part of an extra-cost option pack (see page 35 for details).

¹ = Standard on 1.9CDTi 16v models only. Optional at extra cost on 1.6i 16v VVT and 1.8i 16v VVT models.
² = Also available as part of an extra-cost option pack (see page 35 for details).



16-inch Twin Spoke alloy wheel, standard on Sport models.



18-inch 11-spoke alloy wheel, part of Plus Pack on Design models.

Sport switch

D1 The Sport switch, standard on Design models, improves the responses of both the steering and throttle, giving the driver crisper initial acceleration and sharper, more direct turn-in when cornering. On vehicles fitted with automatic transmission, the Sport switch also controls the transmission Sport mode.

Wheels and tyres

Features	TwinTop	Sport	Design
16-inch Structure wheels with 205/55 R 16 ultra-low profile tyres	●		
16-inch Twin Spoke alloy wheels with 205/55 R 16 ultra-low profile tyres		●	
17-inch 10-spoke alloy wheels with 225/45 R 17 ultra-low profile tyres			●
17-inch five-spoke alloy wheels with 225/45 R 17 ultra-low profile tyres		□	
18-inch 11-spoke alloy wheels with 225/40 R 18 ultra-low profile tyres			□
Emergency tyre repair kit in lieu of spare wheel	●	●	●
Steel space-saver spare wheel/tyre	○	○	○

Mechanical features (see pages 36/37 for details)

Features	TwinTop	Sport	Design
Five-speed manual gearbox (1.6i 16v VVT/1.8i 16v VVT)	●	●	●
Six-speed manual gearbox (2.0i 16v Turbo/1.9CDTi 16v)	●	●	●
Four-speed automatic transmission (1.8i 16v VVT only)	○	○	○
Sport switch D1			●

Exterior features

Standard features • Heated rear window with automatic timed cut-off • Electrically operated front and rear windows with safety autoreverse and one-touch facility • Body-colour door mirrors and door handles • Electrically adjustable/heated door mirrors with manual fold-flat function • Chrome-effect window trim • Alloy-effect door sill covers • Honeycomb grille • Body-colour side-protection mouldings • Two-tone horn

Additional features	TwinTop	Sport	Design
Electro-hydraulic retractable steel roof	●	●	●
Remote control roof operation		●	●
Dark-style headlights	●	●	
Chrome-effect headlights			●
Rain-sensitive windscreen wipers			●
Automatic Lighting Control (ALC)			●
Chrome-effect sports exhaust tailpipe			●
Front fog lights		●	●
Windbreak	○	○	●
Adaptive Forward Lighting (AFL) incorporating dark-style bi-xenon headlights with dynamic beam levelling and high pressure headlight washers – see D4 and D5 on page 39			○
Rear parking distance sensor	○	○	○
Two-coat metallic or pearlescent paint	○	○	○

Option packs

	TwinTop	Sport	Design
Leather Pack • Leather seat facings • Electrically heated sports front seats • Tilt and lumbar adjustment on driver's side • Indirect door night lighting			○
Plus Pack • 17-inch five-spoke alloy wheels with 225/45 R 17 ultra-low profile tyres • Cruise control		○	
Plus Pack • 18-inch 11-spoke alloy wheels with 225/40 R 18 ultra-low profile tyres • Cruise control			○
Premium Pack • 18-inch 11-spoke alloy wheels with 225/40 R 18 ultra-low profile tyres • Cruise control • CD 70 stereo radio/CD with MP3 capability/satellite navigation with colour monitor			○

Audio and communications

Features	TwinTop	Sport	Design
CD 30 MP3 stereo radio/CD player with MP3 • AM/FM stereo radio with 24 station presets • RDS with Traffic Programme • CD player with MP3 capability • Remote display • 20 watts per channel output • 7 speakers	●	●	●
CD 70 stereo radio/CD player with MP3/satellite navigation • Satellite navigation system • AM/FM stereo radio with 40 station presets • RDS with Traffic Programme • CD player with MP3 capability • Remote graphic display with colour monitor • 20 watts per channel output • 7 speakers		○	○ ²
Mobile phone system with Bluetooth® and graphic information display (does not include phone or cradle)	○	○	○
Steering wheel mounted audio controls	●	●	●
Windscreen surround-mounted flexible aerial	●	●	●

Satellite navigation

The CD 70 satellite navigation system uses the international network of GPS (Global Positioning System) satellites, linked to a comprehensive CD-ROM mapping system, to determine your precise location and guide you to your chosen destination virtually anywhere in mainland Britain.

Entering your destination has never been easier, so you can start your journey quickly and without fuss, and it's just as simple to use when on the move. The system features

a split-screen facility, which displays half the screen as a route map while the other half shows directional arrows to give immediate information about road junctions and, if that was not enough, there are audible direction prompts to give details about road numbers and motorway junction numbers too. You can even plan your route to avoid toll roads.

The CD 70 also features Traffic Message Channel (TMC), a specific application of RDS used for broadcasting real-time traffic information, delivered to the driver either visually or verbally. TMC can also offer dynamic route guidance – alerting the driver to a problem on the planned route and calculating an alternative route to avoid the incident.



Steering wheel mounted audio controls.



CD 70 satellite navigation system, showing the split-screen facility.

● = Standard equipment
○ = Optional at extra cost
□ = Only available as part of an extra-cost option pack
2 = Also available as part of an extra-cost option pack.

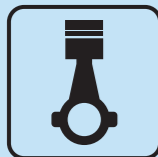

200PS
2.0i 16v Turbo –
effortlessly
powerful



47.1mpg
1.9CDTi 16v
(150PS) engine
is powerful yet
economical

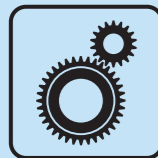

Transmission
Manual and
automatic versions
available

Engines

	1.6i 16v VVT ECOTEC-4 Petrol	1.8i 16v VVT ECOTEC-4 Petrol	2.0i 16v Turbo ECOTEC-4 Petrol	1.9CDTi 16v ECOTEC-4 Turbo diesel with Diesel Particulate Filter (DPF)
Capacity	1598cc	1796cc	1998cc	1910cc
Maximum power	115PS (85kW) @ 6000rpm	140PS (103kW) @ 6300rpm	200PS (147kW) @ 5400rpm	150PS (110kW) @ 4000rpm
Maximum torque	155Nm (114 lb.ft.) @ 4000rpm	175Nm (129 lb.ft.)* @ 3800rpm	262Nm (193 lb.ft.) @ 4200rpm	320Nm (236 lb.ft.) @ 2000rpm
Configuration	4 cylinders, 16 valves, double overhead camshafts			
Fuel/induction system	Naturally aspirated. Variable Valve Timing (VVT) Multi-point sequential fuel injection	Naturally aspirated. Variable Valve Timing (VVT) Multi-point sequential fuel injection	Water-cooled turbocharger with air-cooled intercooler Multi-point sequential fuel injection	Variable geometry turbocharger with intercooler. Common rail fuel injection
Service intervals	20,000 miles or 1 year (whichever occurs sooner)			
<i>Benefit in kind company car taxation – 2006/07 and 2007/08 tax years</i>				
Manual	20%	24%	32%	22%
Automatic	–	25%	–	–

* = Please note, 1.8i 16v VVT models fitted with optional automatic transmission develop 170Nm (125 lb.ft.) of torque.

Performance, fuel economy and emissions

	Performance (manufacturer's figures)			Fuel economy mpg (litres/100km)				CO ₂ emissions (g/km)
	Maximum speed (mph)	Acceleration (secs) 0-60mph 30-50mph (4th gear)	Wheel size (inches)	Urban driving	Extra- urban driving	Combined figure		
1.6i 16v VVT	119	12.4	9.8	16/17	31.0 (9.1)	50.4 (5.6)	40.9 (6.9)	166
1.8i 16v VVT	130	10.7	8.0	16/17/18	27.4 (10.3)	45.6 (6.2)	36.7 (7.7)	185
1.8i 16v VVT automatic	117	11.9	–	16/17/18	26.2 (10.8)	43.5 (6.5)	34.9 (8.1)	194
2.0i 16v Turbo	147	8.3	5.7	17/18	21.2 (13.3)	38.7 (7.3)	29.7 (9.5)	228
1.9CDTi 16v	132	9.5	6.5	16/17/18	37.2 (7.6)	55.4 (5.1)	47.1 (6.0)	160

The fuel consumption figures shown comply with EC directive 1999/100 to provide a realistic indication of fuel consumption by taking into account everyday driving conditions, such as cold starts, acceleration, braking and even differences in the weight of models with the same engine. **Important:** the results given relate to the particular car tested; inevitably there are differences between individual cars of the same model. In addition, some cars may incorporate particular modifications. Driving style, road and traffic conditions, vehicle mileage and standard of maintenance may also affect fuel consumption; therefore the results do not express or imply any guarantee of the fuel consumption attainable.

Vauxhall Assistance and warranties*

- A one-year unlimited mileage manufacturer's warranty
- Second and third year no-fee customer option warranty up to 60,000 miles (from first registration)
- Vauxhall Assistance for 12 months from first registration
- Six years' body panel anti-perforation warranty

* = Warranty is only available on vehicles sourced from Vauxhall Motors Ltd. Terms and conditions apply - please see your Vauxhall retailer for details.

Optional transmission

Four-speed automatic transmission: Available at extra cost on 1.8i 16v VVT models. Vauxhall's four-speed automatic transmission features an electronically controlled adaptive driving programme, which tailors its gear changes to match your driving conditions. It also features a winter mode, which selects a higher than normal gear, in icy conditions, to reduce the possibility of wheelspin in icy conditions.

Steering

- Electro-hydraulic power-assisted steering
- Turning circle (kerb-to-kerb): 10.75m (35.3ft.)

Suspension

Front: Independent. Lightweight MacPherson struts with gas-pressure dampers and coil springs. Anti-roll bar. Hydro-formed subframe offers increased lateral stiffness. Hydraulic control arm bushing to give improved insulation from road noise.

Rear: Lightweight torsion beam rear axle with one-piece, hollow cast trailing arms. Built-in anti-roll bar. Progressive-rate double conical mini-block springs and gas-pressure dampers

Brakes

- Anti-lock Braking System (ABS)
- Dual circuit, diagonally split braking system

1.6i 16v VVT

Front ventilated discs: 280mm diameter
Rear discs: 264mm diameter

1.8i 16v VVT

Front ventilated discs: 280mm diameter
Rear discs: 264mm diameter

2.0i 16v Turbo

Front ventilated discs: 308mm diameter
Rear discs: 264mm diameter

1.9CDTi 16v

Front ventilated discs: 308mm diameter
Rear discs: 264mm diameter

Body

- Electro-hydraulic retractable hard top
- Aerodynamic drag co-efficient: Cd 0.31 (with roof raised)

Fuel tank capacity

All models – 52 litres (11.4 gallons).

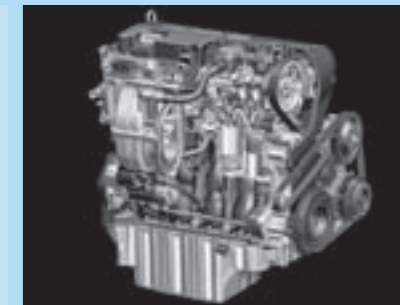

New 1.6i 16v VVT engine.

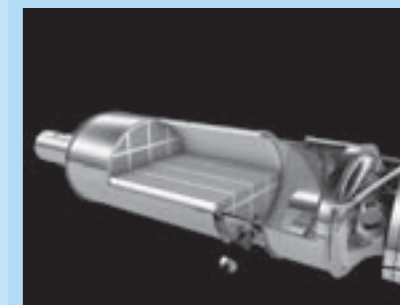

Diesel Particulate Filter (DPF).

Exterior dimensions millimetres (inches)

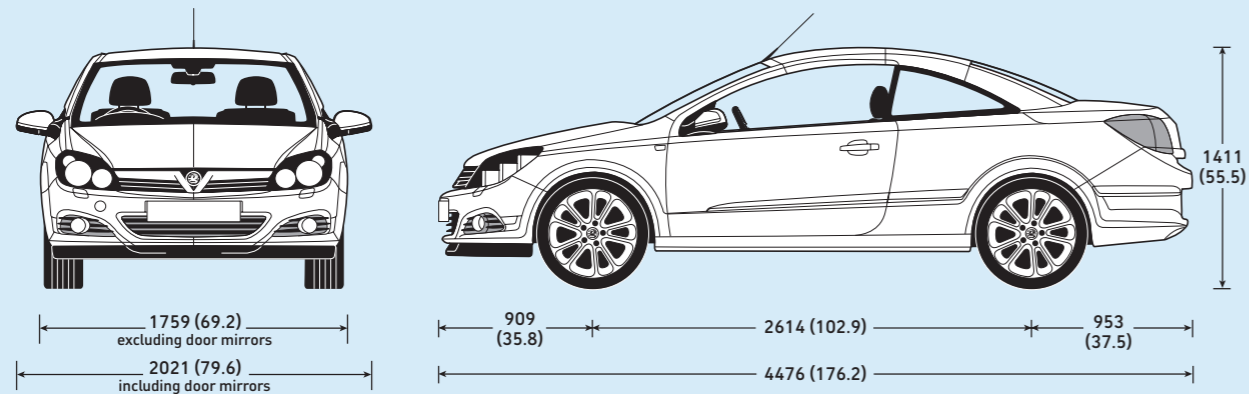

Luggage capacities (measured using the ECIE method)

	litres	cu.ft.
Roof up	440	15.5
Roof down	205	7.2



Easy Load boot access system

The Easy Load function assists the loading and unloading of the boot when the roof is lowered. Pressing the button, located on the load sill, raises the folded roof by 25cm and allows easy access to the boot.

When finished, simply press the button again and the roof panels are lowered back into position.



Weights and towing data kg

	Kerbweight (Gross vehicle weight)	Max. towing weights Trailer with brakes (without brakes)
1.6i 16v VVT TwinTop/Sport	1440 (1865)	1050 (745)
1.8i 16v VVT Sport	1445 (1870)	1200 (750)
1.8i 16v VVT Sport automatic	1448 (1895)	1200 (750)
1.8i 16v VVT Design	1556 (1870)	1200 (750)
1.8i 16v VVT Design automatic	1558 (1895)	1200 (750)
2.0i 16v Turbo Design	1645 (1955)	1200 (750)
1.9CDTi 16v (150PS) Sport	1553 (1990)	1200 (750)
1.9CDTi 16v (150PS) Design	1656 (1990)	1200 (750)

Gross vehicle weight is the total permissible weight of the vehicle including passengers and their luggage. To determine total carrying capacity, deduct kerbweight from gross vehicle weight. Note that the figure obtained will include the weight of the driver, passengers and any optional equipment or accessories. The **maximum towing weights** are based on the ability of the car, with two occupants of 70kg each, to restart on a 12% gradient, which is approximately 1 in 8.3, at sea level. At altitudes above 1500 metres, the engine output may drop with a corresponding reduction in towing capability. Any extra weight, such as luggage or additional passengers, should be deducted from the maximum towing weight. With a trailer fully loaded, **maximum noseweight** should not exceed 75kg. Always fit Vauxhall towing attachments and accessories available from your Vauxhall retailer. They are designed specifically for Vauxhall models and carry a 12-month guarantee.

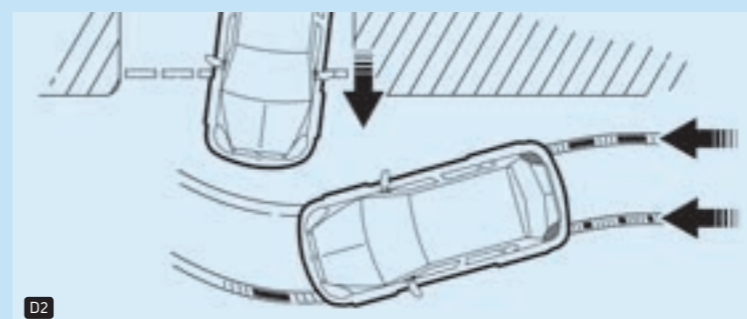

Anti-lock Braking System (ABS) with Cornering Brake Control (CBC)
D2. Cornering brake control makes the car easier to control in extreme situations, particularly when braking sharply on a bend. It is particularly effective when carrying out emergency procedures, such as avoiding a child's ball that's rolled out from the kerb. The system works by sensing the different rotational speeds of the individual road wheels and co-ordinating the level of braking pressure applied to each wheel. CBC is an integral part of TwinTop's comprehensive ABS.

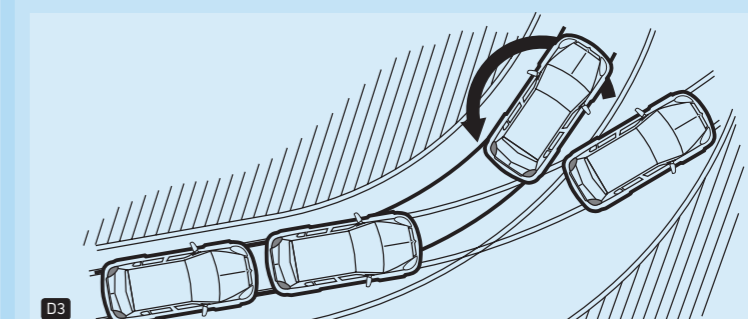

Electronic Stability Programme-plus (ESP-plus)
D3. ESP-plus provides enhanced yaw compensation during understeer or oversteer. The system works by monitoring the front and rear of the car, comparing their respective directions of travel going in to the bend with the input received through the steering wheel. If the vehicle starts to slide, ESP-plus applies corrective braking to the appropriate wheel, or wheels, compensating for the slide and helping you regain control more rapidly.

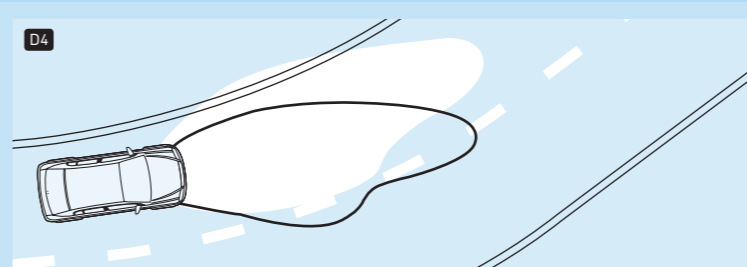

Adaptive Forward Lighting (AFL)
 Adaptive Forward Lighting is a sophisticated new lighting system that allows TwinTop drivers to see around corners. This optional bi-xenon system employs two main functions:

Curving Light
D4. Controlled by a combination of steering wheel movement and sensors for the vehicle's speed and yaw angle, the Curving Light function allows the headlight beam to move up to 15 degrees left or right of the straight ahead position. This ensures the light is always following the trajectory plotted by the front wheels, rather than simply pointing straight ahead.

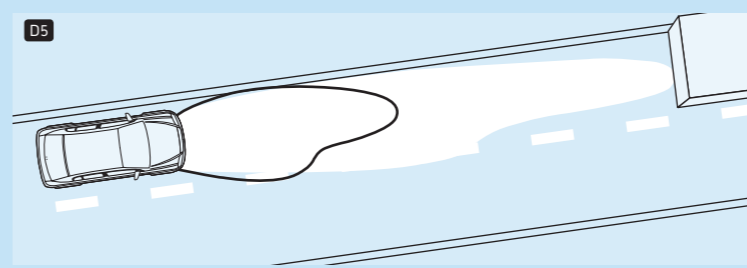

Motorway Light
D5. At speeds above 65mph, AFL raises the dipped headlight beam to extend the range of vision for increased safety at higher speed. The beam automatically returns to its normal position when the car falls below that speed. TwinTop is one of the first cars in its class to offer such technology.