

Astra TwinTop

2010 Models Edition 1



NEVER STOP... MOVING

Because your heart says convertible. And your head says coupé.
Astra TwinTop. Fall in love with driving again.





Environmental issues 10

Roof system 12

Driving dynamics 14

Safety and security 16

Features 18

Astra TwinTop line-up 20

Options and accessories 24

Colours and trims 28

Equipment 32

Technical data 36

This brochure covers Astra TwinTop Air, TwinTop Sport and TwinTop Design models only. Some of the vehicles shown in this brochure include options and accessories available at extra cost. And not all of the features described are available on every model. So please check the Equipment section for further details. From time to time, we also offer alternative Astra TwinTop models such as Special Editions which are featured in separate literature or can be found on the website www.vauxhall.co.uk



NEVER STOP... **CREATING**

Because the more we get from our cars the more we get out of life.





NEVER STOP... EXPLORING

Because, in Astra TwinTop, there's a great big world out there. And it's all worth seeing.



NEVER STOP... SHARING

Because Astra TwinTop seats four adults – with room for luggage too.









RESPECT YOUR WORLD

We all share a responsibility to look after our world. And Vauxhall has been at the forefront of green automotive initiatives for many years. Most recently, we are looking at new ways to further reduce vehicle CO₂ emissions and working on cleaner, more efficient alternative power sources, including zero-emission fuel cell technology.

But our commitment to preserving the environment goes even further. We have dramatically reduced manufacturing emissions, for example. Our designers aim to use more recycled materials and improve parts recyclability wherever possible.

We also offer free and easily accessible, environmentally friendly, end-of-life vehicle disposal through our partners Autogreen Ltd. And currently initiatives are in place to encourage disposal of older vehicles in return for valuable savings* on newer ones.

That way, we reduce our environmental impact in every phase of every vehicle's life cycle. Because your world is our world, too.

*Terms and conditions apply. Please ask your retailer for details.



▲ Easy load. At 205 litres, TwinTop already boasts an impressive roof-down luggage space, but its exclusive – and very smart – Easy Load function helps you load and unload your luggage more easily. When you push the button, the folded roof section rises by around 25cm, providing easier access to the load area.



▲ Windbreak. We probably don't need to convince you of the benefits of convertible motoring, but what if we could make the experience even better? The TwinTop windbreak helps you enjoy the fresh air without unpleasant draughts. It's standard on TwinTop Design and optional on all other models.

▶ Innovative roof system. The Astra TwinTop roof is brilliantly engineered – three sections, five electric motors, eight hydraulic cylinders and 14 articulated joints. Why? Because we wanted it to look great, and maximise your luggage space too – something else we've achieved with spectacular success. This is clearly not your ordinary steel roof. It's fully automatic, for a start, with no additional clips to release or fasten. Just hold the button, then sit back and relax. Opening and closing safely and securely takes less than 30 seconds. And the system even works on the move at low speeds – up to 18mph to be precise.



◀ Generous seating and luggage space. Talk about having your cake and eating it. The clever folding roof design, coupled with careful shaping of the seat cushions and bolsters, gives enough legroom and shoulder space for two adult rear seat passengers. It also allows you to travel with bags of luggage. With the roof down, Astra TwinTop offers an excellent 205 litres of luggage space. And as a coupé, it boasts a luggage compartment volume of 440 litres. That's even more than the Astra five-door hatchback. And that's not all. There's additional storage space in two compartments in the side panel of the boot. And the handy rear seat load-through facility helps you make room for long items.

▶ Remote control roof operation. Every Astra TwinTop model features remote control for the central deadlocking and ultrasonic security alarm. But on Sport and Design models, the car key can also open and close the TwinTop roof – again by remote control. Go on, impress your friends.





Never stop... thinking

Because really clever technology makes the simple things in life even easier. Sunny morning. Rainy afternoon. No need to worry. Astra TwinTop combines coupé security and refinement with all the fresh air and freedom you'd expect from one of the best looking four-seat, four-season convertibles around. And it's all thanks to an ingenious, three-piece folding steel roof.

Never stop... enjoying

Because the more you drive it, the more you'll love it. TwinTop's dynamic Astra chassis balances serious ride comfort with sure-footed agility and smart active safety features. Whether you choose petrol or diesel, Vauxhall's advanced engine technology also helps make every trip a pleasure. With strong mid-range response, high flexibility and superb fuel economy, your Astra TwinTop will be easy to drive. And easy on the pocket too.



1.6i 16v VVT and 1.8i 16v VVT. Astra TwinTop's two naturally aspirated petrol engines use Variable Valve Timing, allowing them to provide most of the maximum torque across a wide rev band. The result? Incredible flexibility through the gears, high power and low fuel consumption.

1.9CDTi. TwinTop's sporty 150PS turbo diesel utilises common-rail fuel injection to produce high levels of torque at low speeds – 320Nm between 2000 and 2750rpm – combining superior flexibility and performance with outstanding economy.

Electronic Stability Programme-plus (ESP-plus). Whether it's a wet roundabout or a greasy road – one day you might meet a slippery surface that catches you out. That's the day you'll be glad you specified our latest ESP-plus system, which applies corrective braking to help you regain control. Further explanation can be found in the Technical data section on page 39.



Steering. TwinTop's Electro-Hydraulic Power Steering (EHPS) is smart in so many ways. It's electrically powered, so promotes even greater fuel economy. And it's speed-sensitive too – light at low speeds for easy parking, and progressively smoother and more precise as you speed up.

Transmissions. Choose the 1.9CDTi engine and it'll come with a six-speed manual gearbox. All other models feature a five-speed manual as standard, with a four-speed automatic – with adaptive driving function and Winter mode – also available on 1.8i 16v VVT models.



Intelligent ABS. Most people appreciate the benefits of Anti-lock Braking System (ABS) and four-wheel disc brakes, but Astra TwinTop takes things even further. Cornering Brake Control, Electronic Brakeforce Distribution and Emergency Brake Assist make the car even easier to control and stop in emergency cornering and braking conditions and more effective when it does so. Further explanation can be found in the Technical data section on page 39.

Specially tuned suspension. Every TwinTop features specially tuned suspension with gas-pressure dampers for taut road holding and a controlled ride. Cornering is neutral and agile, steering response precise and stability improved during emergency manoeuvres.



Sport switch. Providing performance to suit your mood, the Sport switch is like having two cars in one, each with its own unique character and instant switching between the two. Push the button for quicker throttle response and sharper steering, plus sportier gearchanges on automatic models.



Never stop... protecting

Because feeling safe behind the wheel is yet another reason why Astra TwinTop feels so good to drive. Astra TwinTop protects you in so many ways. And it's not just the obvious features like airbags and rollover protection. The Astra chassis is engineered to help prevent accidents in the first place. And our security features look after your belongings as carefully as our safety features look after you.



Airbags. Astra TwinTop features a full complement of passive safety measures, including driver's and front passenger's airbags and extensive side-impact protection too. Our improved side-impact airbags feature an enlarged 'Thorax-Pelvis' design to protect your lower and upper body in the event of an impact. And all models have our patented pedal release system and front body-lock seatbelt pretensioners.



◀ ▼ **Active rollover protection system.** It's not exactly something you can leave to chance in a convertible, so it won't come as any surprise to hear that the TwinTop body and chassis are specially reinforced – an additional cross-member in the floor plus high-strength steel tubes in the A-pillars are just two examples. And that's not all. TwinTop Air and TwinTop Sport models feature rigid rollover protection hoops, while Design models feature a pop-up rollover protection system (below). If the car enters an uncontrolled state that could result in it rolling over, a sensor activates two high-strength aluminium rollover hoops, located behind the two rear seats, that pop up and lock into position – all in a fraction of a second.

▼ **Adaptive Forward Lighting (AFL).** Want to see round corners? With optional bi-xenon Adaptive Forward Lighting, the headlight beam moves up to 15 degrees in the direction you turn the steering wheel to light up where you're heading. Above 65mph, it raises the dipped headlight beam slightly, extending the range of vision for increased safety – then automatically returns the beam to its normal position when you fall below that speed. As *Autocar* magazine said: "AFL is easy to get used to and hugely improves visibility for night driving". This advanced option comes with dynamic beam levelling, high-pressure headlight washers and dark-style headlights.

ISOFIX. TwinTop rear seats are pre-fitted with rigid ISOFIX child seat fastening brackets, virtually eliminating the dangers of incorrect child seat installation. For maximum safety, you simply click a compatible Vauxhall ISOFIX accessory child seat into the mounting points engineered in the car.

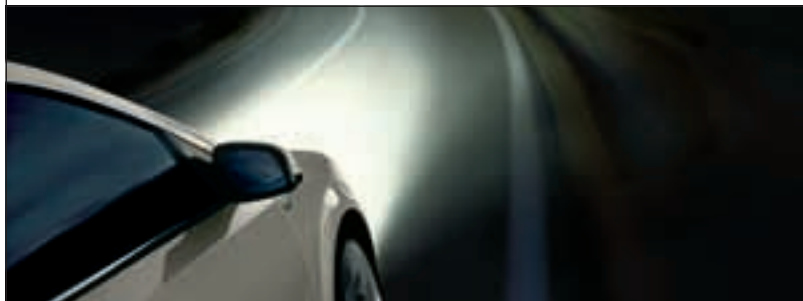

Security. Remote control central deadlocking, an electronic engine deadlock immobiliser and an ultrasonic security alarm are all standard. And our clever door-to-door illumination feature keeps the dipped headlights and rear lights on for 30 seconds to light your way from a garage or car park.

▶ **Air conditioning and Electronic Climate Control (ECC).** From chilled air on hot days to quicker demisting on damp days, air conditioning makes for a fresher interior environment all year round. Move up to ECC – optional on Design models – and you can maintain your preferred interior temperature to within a single degree.



▶ **Satellite navigation.** The optional CD 70 audio system is one of the cleverest Sat Nav systems around, guiding you to your destination with audible direction guidance and route display via the split-screen colour monitor. You can even enter your destination via the on-screen map.



▶ **Keyless entry and start.** Simply carry the unique system key fob in your pocket or handbag and the car will automatically unlock as you operate a door or the boot lid. To start the engine, you simply depress the brake pedal and push the start button on the centre console. To stop the engine press the button again. Please see page 39 of the technical data section for more details.

▶ **Smart features.** Every TwinTop model features a clever overhead lighting console, just above the rear view mirror. It houses the security alarm sensors and the roof operation switch. Choose TwinTop Design and your driver environment is packed with clever ideas, all aimed at keeping your attention on the road ahead. Activate the rain-sensitive wipers and they'll switch themselves on automatically when it rains. Automatic lighting control does the same for the headlights when it starts to get dark. And the electrochromatic rear-view mirror dips automatically to reduce any glare from the headlights on the car behind.



▶ **Big sounds.** If in-car audio is your thing, look no further. Astra TwinTop systems are available with all the latest technologies. The double-DIN fascia format makes every system easier to operate. A remote display and steering wheel audio controls are standard across the range. And the standard CD player/stereo radio can play MP3 tracks from CD or, by using the new auxiliary-in socket, play tracks direct from your personal MP3 player. Optional systems include satellite navigation and fully integrated mobile phone technology, with both voice activation and Bluetooth® wireless connectivity. Turn to page 35 for more information on the satellite navigation system.





Never stop... relaxing

Because modern life's so hectic, you can't have enough places to call home. The more at home you feel in your car, the more you enjoy your drive, and the easier it is to focus on the job in hand. So the Astra TwinTop interior space is light and comfortable. And it's easy to find the perfect seating position, the right interior temperature and your favourite audio choice.

TWINTOP AIR

With TwinTop Air, you don't trade a retractable roof for other features. This model packs a lot more than you might expect.

Standard features include:

- Remote control central deadlocking
- Remote control ultrasonic alarm system
- CD player with MP3 format/auxiliary-in socket/stereo radio (CD 30 MP3)
- Steering wheel mounted audio controls
- Air conditioning
- Steering column adjustable for reach and rake
- Leather-covered steering wheel
- Height-adjustable front seats
- Electrically operated windows
- Electrically adjustable/heated door mirrors
- 16-inch Structure wheels with 205/55 R 16 ultra-low profile tyres
- Four airbags
- Anti-lock Braking System
- Dark-style headlights



Engine availability	Insurance groups (ABI)	
	20	50
1.6i 16v VVT	9E	16E

Model illustrated features two-coat metallic paint and Smoker Pack (retailer-fit only), optional at extra cost.

Please note: Insurance groups relate to both the previous 20 group rating and the new 50 group rating.

TWINTOP SPORT

TwinTop Sport comes with more cool features, including remote control roof operation, and a wider colour choice too.

Standard features include:

- Remote control central deadlocking
- Remote control ultrasonic alarm system
- CD player with MP3 format/auxiliary-in socket/stereo radio (CD 30 MP3)
- Air conditioning
- Leather-covered steering wheel
- Height-adjustable front seats
- Electrically operated windows
- Electrically adjustable/heated door mirrors
- Four airbags
- Anti-lock Braking System

Additional features over and above TwinTop Air models:

- 16-inch seven twin-spoke alloy wheels with 205/55 R 16 ultra-low profile tyres
- Front fog lights
- Trip computer
- Remote control roof operation

Optional TwinTop Sport Plus Pack

- Cruise control
- 17-inch five-spoke alloy wheels with 225/45 R 17 ultra-low profile tyres

Model illustrated features Plus Pack, Smoker Pack (retailer-fit only) and two-coat pearlescent paint, optional at extra cost.



Engine availability	Insurance groups (ABI)	
	20	50
1.6i 16v VVT	8E	14E
1.8i 16v VVT	10E	18E
1.8i 16v VVT automatic	10E	18E
1.9CDTi 16v	12E	21E

Please note: Insurance groups relate to both the previous 20 group rating and the new 50 group rating.

TWINTOP DESIGN

Astra TwinTop Design. A model that puts the accent on modern luxury, maximum style and serious equipment.

Standard features include:

- Remote control central deadlocking
- Remote control ultrasonic alarm system
- Air conditioning
- Height-adjustable front seats
- Electrically operated windows
- Front fog lights
- Four airbags
- CD player with MP3 format/auxiliary-in socket/stereo radio (CD 30 MP3)
- Chrome-effect headlights

Additional features over and above Sport models:

- 17-inch ten-spoke alloy wheels with 225/45 R 17 ultra-low profile tyres
- Electronic Stability Programme-plus
- Sport switch
- Splice cloth/Morrocana seat trim
- Leather-covered sports steering wheel
- Rain-sensitive windscreen wipers
- Electro-chromatic anti-dazzle rear-view mirror
- Automatic lighting control
- Pop-up rollover bar protection system
- Height-adjustable rear seat head restraints
- Windbreak
- Chrome-effect sports exhaust tailpipe
- Keyless entry and start

Model illustrated features Leather Pack and two-coat metallic paint, optional at extra cost.

Engine availability	Insurance groups (ABI)	
	20	50
1.8i 16v VVT	10E	18E
1.8i 16v VVT automatic	10E	18E
1.9CDTi 16v	12E	22E

Please note: Insurance groups relate to both the previous 20 group rating and the new 50 group rating.

Optional TwinTop Design Plus Pack

- Cruise control (right)
- 18-inch 11-spoke alloy wheels with 225/40 R 18 ultra-low profile tyres (below)



Optional TwinTop Design Premium Pack

- Cruise control (above)
- 18-inch 11-spoke alloy wheels with 225/40 R 18 ultra-low profile tyres (left)
- Satellite navigation with colour monitor/CD player with MP3 format/auxiliary-in socket/stereo radio (CD 70)





TwinTop Design

Options and accessories

Vauxhall options and accessories are all about choice – selecting your new car, then personalising it to suit yourself. There's a choice of factory-fitted options and a huge range of retailer-fit accessories. You'll find further information on the following pages or just ask your Vauxhall retailer for more details.



VXR Styling

Inspired by our hugely successful racing team, VXR styling products reflect their experience, knowledge and passion for style and performance. An optional factory-fit exterior styling pack (illustrated left and below) is available plus a selection of individual accessory styling products which can be fitted by your local Vauxhall retailer. VXR styling products – add flair, personality and excitement to your Astra TwinTop.

◀ ▶ Astra TwinTop VXR Styling Pack One*

- Front lower spoiler
- Side sills
- Rear lower skirt
- Rear lip spoiler

**Sport and Design models only.*



Design model illustrated (left and above) also features Adaptive Forward Lighting and Plus Pack consisting of 18-inch 11-spoke alloy wheels and cruise control, both optional at extra cost.

Irmscher Styling

Developed in conjunction with auto design specialists Irmscher International, Astra TwinTop styling accessories perfectly complement the vehicle's lines, as well as being manufactured to the same exacting standards as the car itself.

▼ **Irmscher alloy wheels.** They're the perfect way to personalise your Astra TwinTop. With a huge range to choose from (style illustrated is GT Star), and sizes from 16 to 19 inches, you're sure to find one to suit your style and budget. And don't forget to ask about our accessory wheel locking kits too.



▲ **Sports silencer.** For distinctive looks (with chrome-plated tailpipes) and a sportier exhaust note, these split oval design tailpipes are the perfect choice for your Astra TwinTop.



▶ **Cross hatch front grille.** Being different is easy with the cross hatch front grille from Irmscher. Featuring an aluminium upper strip with a laser-etched 'Irmscher' logo it adds style and individuality.



Available individually or in special packs at great prices, Astra TwinTop options can make life better in so many ways. Alloy wheels, satellite navigation, leather trim – there's a huge range to choose from. Simply make your choice when you order your new car and it'll be fitted at the factory for you. You'll find further information on availability in the Equipment section or you can ask your Vauxhall retailer.

 **Leather Pack.** For the ultimate in TwinTop Design interior trim, choose the optional Leather Pack. It comprises leather seat facings and electrically heated sports front seats (with tilt and lumbar adjustment on driver's side).

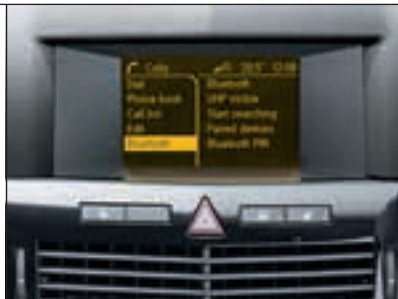

 **Bluetooth® technology.** TwinTop models can now be specified with the latest mobile phone* technology, operated via the car's steering wheel mounted audio controls. Fully integrated into the car's audio system, it has voice activation and Bluetooth® wireless connectivity.

Rear parking sensors. This clever early warning system helps safeguard your car. When reverse gear is selected, the system beeps as you reverse close to an obstruction, changing to a continuous tone when the object is approximately 300mm away.



INDIVIDUAL OPTIONS INCLUDE:

- Adaptive Forward Lighting, incorporating dark-style bi-xenon headlights with dynamic beam levelling and high-pressure headlight washers
- Rear parking distance sensor
- Windbreak (right)
- Satellite navigation with colour monitor (CD 70)
- Electronic Stability Programme-plus
- Mobile phone system* with Bluetooth® wireless connectivity
- Cruise control
- CD autochanger with MP3 format/ stereo radio (CDC 40)
- Electronic Climate Control (ECC)

*Please refer to the online Vauxhall Car and Accessory Price Guide for a list of phone-specific cradles.





Vauxhall accessories are the right choice for your Astra TwinTop. Whatever you're into, there's certain to be a Vauxhall accessory with your name on it; all fitted by trained Vauxhall professionals. We've only featured a small selection of what's available here. The Vauxhall Car Accessory Brochure gives further details.

 **Detachable tow bar.** The detachable tow bar is easily mounted and detached for convenience, with 12N, 12S or 13 PIN electrics at additional cost.



Headlight protectors. They're fitted in moments, yet provide real protection for your headlights against chips and cracks. Tailor-made for your Astra TwinTop, they're available in a standard format, carbon fibre-effect and continental touring with built-in headlight deflectors for driving abroad.



  **Protection Pack.**

- Velour mats
- Windbreak

FURTHER ACCESSORIES AVAILABLE INCLUDE:

- Child seats
- Rubber mats
- Electrically chilled 12-litre cool bag
- Parking sensors
- Alloy wheels
- Windbreak

 **Safety Pack.**

- First aid kit
- Warning triangle
- Hi-visibility vest



Exterior colours

▶ Royal Blue – solid



▶ Metro Blue – metallic



▶ Power Red – solid



▶ Silver Lightning – metallic



▶ Olympic White – solid



▶ Technical Grey – metallic



▶ Olympic White – solid
Black and White Special Pack*



▶ Sovereign Silver – metallic



Great paint colours and exclusive trim choices – including unique Saddle Brown leather.
It's all on view, don't forget. So choose carefully!

▶ Black Sapphire – pearlescent



▶ Iceberg – pearlescent



▶ Ultra Blue – pearlescent



▶ Oriental Blue – pearlescent



▶ Panacotta – pearlescent



** Black and White Special Pack featuring black roof and door mirrors available as a no-cost option with Olympic White only*

Due to the limitations of the printing process the colours reproduced may vary slightly from the actual paint colour or trim material. As a result they should be used as a guide only. Your Vauxhall retailer has a comprehensive display of all our paint samples and trim swatches. Vehicle illustrated is a non-specific model.

Interior trims



Charcoal Leather

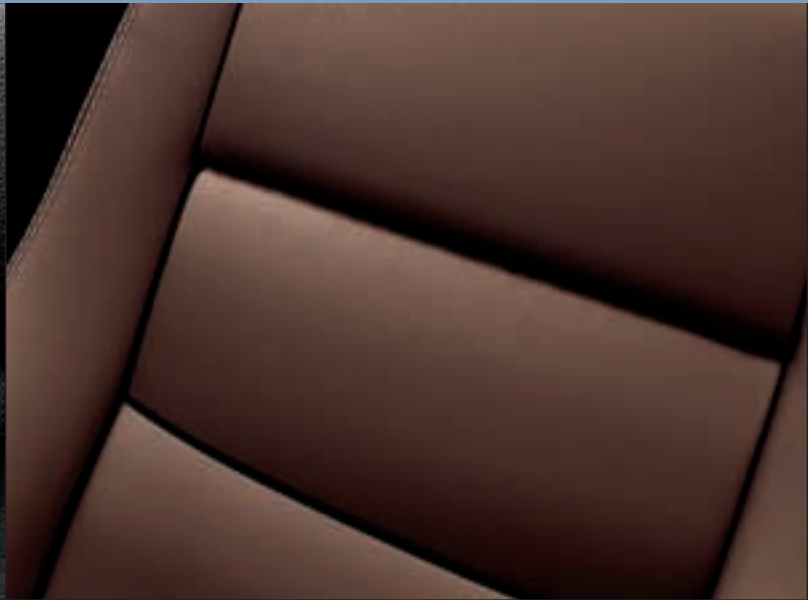

Saddle Brown Leather

Alpha cloth Charcoal

Splice cloth/Morrocana

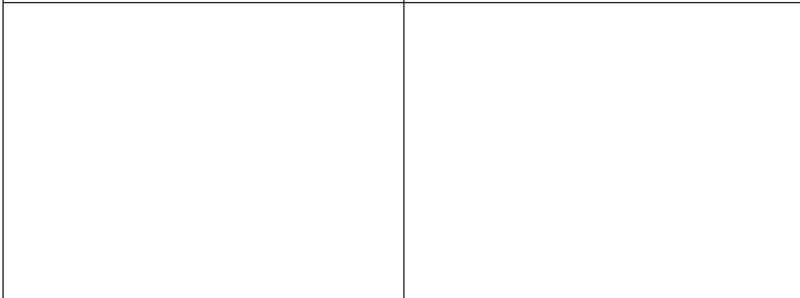

Exterior colours

Model, trim name and trim colour

	Air Alpha cloth	Sport Alpha cloth	Design Splice cloth/Morrocana	Design Leather*
Solid				
Royal Blue	Charcoal	Charcoal	Charcoal	Charcoal or Saddle Brown
Power Red (two-coat)	Charcoal	Charcoal	Charcoal	Charcoal
Olympic White	-	Charcoal	Charcoal	Charcoal or Saddle Brown
Olympic White – Black and White Special Pack**	-	Charcoal	Charcoal	Charcoal
Two-coat metallic*				
Metro Blue	-	Charcoal	Charcoal	Charcoal or Saddle Brown
Silver Lightning	-	Charcoal	Charcoal	Charcoal or Saddle Brown
Technical Grey	-	Charcoal	Charcoal	Charcoal or Saddle Brown
Sovereign Silver	Charcoal	Charcoal	Charcoal	Charcoal or Saddle Brown
Two-coat pearlescent*				
Black Sapphire	Charcoal	Charcoal	Charcoal	Charcoal or Saddle Brown
Ultra Blue	-	Charcoal	Charcoal	Charcoal or Saddle Brown
Panacotta	-	Charcoal	Charcoal	Charcoal or Saddle Brown
Iceberg	-	Charcoal	Charcoal	Charcoal or Saddle Brown
Oriental Blue	-	Charcoal	Charcoal	Charcoal or Saddle Brown

- = Exterior colour listed is not available on this model. * = Optional at extra cost. ** = No-cost option.

Contents

Equipment

Safety Security	32
-----------------	----

Facia, instruments and controls Interior features Heating and ventilation	33
---	----

Wheels and tyres Mechanical features Exterior features	34
--	----

Option packs Audio and communications	35
--	----

Technical data

Engines Performance, fuel economy and emissions	36
--	----

Vauxhall Assistance and warranties Optional transmission Steering Suspension Brakes Body Fuel tank capacity	37
---	----

Exterior dimensions Luggage capacities Weights and towing data	38
--	----

Features explained	39
--------------------	----

Safety

Standard features: • Driver's airbag • Front passenger's airbag • Front seat side-impact airbags • Energy-absorbing steering column • Pedal release system – Reduces potential injury to the driver's legs and feet during a severe frontal impact • Laminated windscreen • Side-impact protection beams • Integral protective side door padding • Reinforced passenger safety cell

• **ISOFIX child seat restraint system for rear seats (does not include child seat)** – Secures ISOFIX child safety seats to the vehicle itself, virtually eliminating the dangers that can result from improper installation

• **Anti-lock Braking System (ABS)** • **Electronic Brakeforce Distribution (EBD)** – Distributes the braking force between the wheels most able to use it, allowing stable and efficient braking • **Cornering Brake Control (CBC)** – see **D2** on page 39 • **Emergency Brake Assist (EBA)** – Increases applied brake force in emergency braking situations • **Adaptive Brake Lights (ABL)** – If the driver brakes hard enough to activate the ABS the brake lights flash on and off at the rate of four times per second, thus warning following vehicles that heavy braking is in progress

• **Height-adjustable front seat head restraints** • **Pyrotechnic front body-lock seatbelt pretensioner system** – Tightens the seatbelt during the early stages of a frontal impact • **Front seatbelt force limiters** – Reduce potential upper body injuries during a frontal impact • **Anti-submarining ramps in all seats** – Help prevent occupants sliding underneath the lap belt during a collision

Additional features

	Air	Sport	Design
Electronic Stability Programme-plus (ESP-plus) with traction control – see D3 on page 39	○	● ¹	●
Two integral rear rollover protection hoops	●	●	
Two pop-up rear rollover protection bars			●
Two height-adjustable rear seat head restraints			●

Security

Standard features • Remote control central deadlocking (doors, boot lid, fuel filler flap) • Visible Vehicle Identification Number (VIN) plate • 'Key left in ignition' audible warning • Electronic engine deadlock immobiliser • Electronic theft protection for audio equipment • Locking wheel bolts for alloy wheels (where fitted) • Driver's internal central locking switch • Door-to-door illumination – Keeps the headlights and rear lights on for 30 seconds after the car doors are locked • Folding key • Remote control ultrasonic security alarm system

Additional feature

	Air	Sport	Design
Keyless entry and start – see D4 on page 39			●

Facia, instruments and controls

Standard features • Multi-function display showing time, date, audio information and outside air temperature (with ice warning function) • Rev counter • Digital clock with automatic RDS time adjustment • Black instruments with chrome edging • Steering column adjustable for reach and rake • Electronic odometer and trip odometer • Instrument panel light dimmer • Handbrake-on/low brake fluid level and low fuel level warning lights • Service interval monitor

Additional features	Air	Sport	Design
Three-spoke leather-covered steering wheel	●	●	
Three-spoke leather-covered sports steering wheel			●
Multi-function trip computer		●	●
Cruise control	○	○ ²	○ ²

Interior features

Standard features • Sports-style front seats • Driver's and front passenger's seats with reach and recline adjustment • Driver's and front passenger's seat height adjusters • Lockable, split-level glovebox • 12-volt auxiliary power socket within centre console • Chrome-effect internal door handles • Charcoal fleece velour carpet • Fully carpeted luggage area • Illuminated luggage area and glovebox • Front map reading lights integral with courtesy light • Driver's and front passenger's sunvisors with vanity mirrors • Fade up/fade down courtesy lighting operated by door switches • Easy Load boot access system • Rear seat centre armrest with load-through facility • Drinks holder between front seats • Matt chrome-effect inserts on facia and doors

Additional features	Air	Sport	Design
Electro-chromatic anti-dazzle rear-view mirror			●
Alpha cloth seat trim	●	●	
Splice cloth seat trim with Morrocana-trimmed side bolsters			●
Leather seat facings (includes heated front seats with variable temperature settings)			□
Sports front seats			□
Matt chrome-effect centre console	●	●	
Piano black-effect centre console			●

Heating and ventilation

Standard features • Air conditioning • Interior pollen filter • Air recirculation with activation light • Air blend heater with four-speed fan

Additional feature	Air	Sport	Design
Electronic Climate Control (ECC) incorporating air conditioning with air recirculation			○



Front and side-impact airbags.



Two integral rear rollover protection hoops.

- = Standard equipment.
- = Optional at extra cost.
- = Only available as part of an extra-cost option pack (see page 35 for details).

- 1 = Standard on 1.9CDTi 16v models only. Optional at extra cost on 1.6i 16v VVT and 1.8i 16v VVT models.
- 2 = Also available as part of an extra-cost option pack (see page 35 for details).



16-inch seven twin-spoke alloy wheel, standard on Sport models.



18-inch 11-spoke alloy wheel, part of Plus Pack on Design models.

Sport switch

D1 The Sport switch, standard on Design models, improves the responses of both the steering and throttle, giving the driver crisper initial acceleration and sharper, more direct turn-in when cornering. On vehicles fitted with automatic transmission, the Sport switch also controls the transmission Sport mode.

Wheels and tyres

Features	Air	Sport	Design
16-inch Structure wheels with 205/55 R 16 ultra-low profile tyres	●		
16-inch seven twin-spoke alloy wheels with 205/55 R 16 ultra-low profile tyres		●	
17-inch 10-spoke alloy wheels with 225/45 R 17 ultra-low profile tyres			●
17-inch five-spoke alloy wheels with 225/45 R 17 ultra-low profile tyres		□	
18-inch 11-spoke alloy wheels with 225/40 R 18 ultra-low profile tyres			□
Emergency tyre inflation kit in lieu of spare wheel	●	●	●
Steel space-saver spare wheel/tyre	○	○	○

Mechanical features

Features	Air	Sport	Design
Five-speed manual gearbox (1.6i 16v VVT)	●	●	
Five-speed manual gearbox (1.8i 16v VVT)		●	●
Six-speed manual gearbox (1.9CDTi 16v)		●	●
Four-speed automatic transmission (1.8i 16v VVT only)		○	○
Sport switch D1			●

Exterior features

Standard features • Heated rear window with automatic timed cut-off • Electrically operated front and rear windows with safety autoreverse and one-touch facility • Body-colour door mirrors and door handles • Electrically adjustable/heated door mirrors with manual fold-flat function • Chrome-effect window trim • Alloy-effect door sill covers • Honeycomb grille • Body-colour side-protection mouldings • Green-tinted glass

Additional features	Air	Sport	Design
Electro-hydraulic retractable steel roof	●	●	●
Remote control roof operation		●	●
Dark-style headlights	●	●	
Chrome-effect headlights			●
Rain-sensitive windscreen wipers			●
Automatic Lighting Control (ALC)			●
Chrome-effect sports exhaust tailpipe			●
Two-tone horn		● ³	● ³
Front fog lights		●	●
Windbreak	○	○	●
Adaptive Forward Lighting (AFL) incorporating dark-style bi-xenon headlights with dynamic beam levelling and high pressure headlight washers			○
Rear parking distance sensor	○	○	○
Two-coat metallic or pearlescent paint	○	○	○

Option packs

	Air	Sport	Design
Leather Pack • Leather seat facings • Electrically heated sports front seats • Tilt and lumbar adjustment on driver's side			○
Plus Pack • 17-inch five-spoke alloy wheels with 225/45 R 17 ultra-low profile tyres • Cruise control		○	
Plus Pack • 18-inch 11-spoke alloy wheels with 225/40 R 18 ultra-low profile tyres • Cruise control			○
Premium Pack • 18-inch 11-spoke alloy wheels with 225/40 R 18 ultra-low profile tyres • Cruise control • Satellite navigation with colour monitor/CD player with MP3 format/stereo radio (CD 70)			○
VXR Styling Pack One • Body-colour front lower spoiler/rear lower skirt/rear lip spoiler and side sills		○	○
Black and White Special Pack • Olympic White solid paint • Black roof panel • Black door mirrors		N/C	N/C

Audio, communication and navigation

Features	Air	Sport	Design
CD player with MP3 format/stereo radio (CD 30 MP3) • CD player with MP3 format • Auxiliary-in socket • AM/FM stereo radio with 24 station presets • RDS with Traffic Programme • Remote display • 20 watts per channel output • 7 speakers	●	●	●
CD autochanger with MP3 format/stereo radio (CDC 40) • Integral six-disc CD autochanger with MP3 format • AM/FM stereo radio with 36 station presets • RDS with Traffic Programme • Remote graphic display • 35 watts per channel output • 7 speakers		○ ⁴	○ ⁴
Satellite navigation/CD player with MP3 format/stereo radio (CD 70) • Satellite navigation system • CD player with MP3 format • Auxiliary-in socket • AM/FM stereo radio with 40 station presets • RDS with Traffic Programme • Remote graphic display with colour monitor • 20 watts per channel output • 7 speakers		○	○ ²
Mobile phone system with Bluetooth® and graphic information display (does not include phone or phone-specific cradle)	○	○	○
Steering wheel mounted audio controls	●	●	●
Windscreen surround-mounted flexible aerial	●	●	●

Satellite navigation

The CD 70 satellite navigation system uses the international network of GPS (Global Positioning System) satellites, linked to a comprehensive CD-ROM mapping system, to determine your precise location and guide you to your chosen destination virtually anywhere in mainland Britain.

Entering your destination has never been easier, so you can start your journey quickly

and without fuss, and it's just as simple to use when on the move. The system features a split-screen facility, which displays half the screen as a route map while the other half shows directional arrows to give immediate information about road junctions and, if that was not enough, there are audible direction prompts to give details about road numbers and motorway junction numbers too. You can even plan your route to avoid toll roads.

The CD 70 also features Traffic Message Channel (TMC), a specific application of RDS used for broadcasting real-time traffic information, delivered to the driver either visually or verbally. TMC can also offer dynamic route guidance – alerting the driver to a problem on the planned route and calculating an alternative route to avoid the incident.



Steering wheel mounted audio controls.

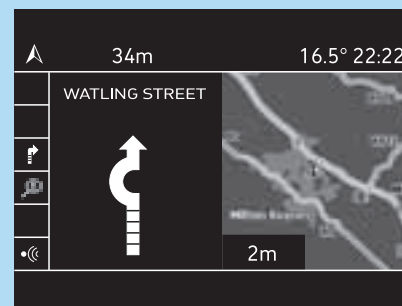

CD 70 satellite navigation system, showing the split-screen facility.

- = Standard equipment.
- = Optional at extra cost.
- = Only available as part of an extra-cost option pack.
- N/C = No-cost option.
- 2 = Also available as part of an extra-cost option pack.
- 3 = Standard on 1.9CDTi 16v only.
- 4 = CDC 40 deletes auxiliary-in socket.

Vauxhall supporting



Smarter driving tips

- Drive at an appropriate speed: – Staying within the speed limit increases driver safety, reduces CO₂ emissions and saves fuel. At 70mph you could be using up to 9% more fuel than at 60mph and up to 15% more fuel than at 50mph
- Drive smoothly at all times: – Anticipate the ebb and flow of the traffic to avoid harsh acceleration and braking
- Reduce your revs: – Change gear earlier to help reduce fuel consumption – try 2500 rpm with petrol engines and 2000 rpm with diesel
- Idling is wasting fuel: – If you're likely to be at a standstill for more than three minutes, switch off the engine to save fuel
- Regularly check your tyre pressures: – Under inflated tyres increase CO₂ emissions whilst incorrectly inflated tyres can be unsafe. Always check your handbook for the correct tyre pressure. This will also help to increase the life of your tyres
- Remove unnecessary items from the car: – Extra weight increases the engine's workload, whilst roof racks and bike carriers increase wind resistance. All burn more fuel and increase CO₂ emissions

Engines

	1.6i 16v VVT ECOTEC-4 Petrol	1.8i 16v VVT ECOTEC-4 Petrol	1.9CDTi 16v ECOTEC-4 Turbo diesel with Diesel Particulate Filter (DPF)
Capacity	1598cc	1796cc	1910cc
Maximum power	115PS (85kW) @ 6000rpm	140PS (103kW) @ 6300rpm	150PS (110kW) @ 4000rpm
Maximum torque	155Nm (114 lb.ft.) @ 4000rpm	175Nm (129 lb.ft.)* @ 3800rpm	320Nm (236 lb.ft.) @ 2000-2750rpm
Configuration	4 cylinders, 16 valves, double overhead camshafts		
Fuel/induction system	Naturally aspirated. Variable Valve Timing (VVT) Multi-point sequential fuel injection	Naturally aspirated. Variable Valve Timing (VVT) Multi-point sequential fuel injection	Variable geometry turbocharger with intercooler. Common rail fuel injection
Service intervals	20,000 miles or 1 year (whichever occurs sooner)		
Benefit in kind company car taxation rates – 2009/10 tax year			
Manual	20%	23%	22%
Automatic	–	26%	–

* = Please note, 1.8i 16v VVT models fitted with optional automatic transmission develop 170Nm (125 lb.ft.) of torque.

Performance, fuel economy and emissions

	Performance (manufacturer's figures)			Fuel economy mpg (litres/100km)				CO ₂ emissions (g/km)
	Maximum speed (mph)	Acceleration (secs) 0-60mph	30-50mph (4th gear)	Wheel size (inches)	Urban driving	Extra- urban driving	Combined figure	
1.6i 16v VVT	119	12.4	9.8	16/17	31.4 (9.0)	51.4 (5.5)	41.5 (6.8)	163
1.8i 16v VVT	130	10.7	8.0	16/17/18	28.2 (10.0)	47.9 (5.9)	38.2 (7.4)	177
1.8i 16v VVT automatic	117	11.9	–	16/17/18	26.4 (10.7)	44.1 (6.4)	35.3 (8.0)	191
1.9CDTi 16v	132	9.5	6.5	16/17/18	37.2 (7.6)	55.4 (5.1)	47.1 (6.0)	159

The fuel consumption figures shown comply with EC directive 1999/100 to provide a realistic indication of fuel consumption by taking into account everyday driving conditions, such as cold starts, acceleration, braking and even differences in the weight of models with the same engine. **Important:** the results given relate to the particular car tested; inevitably there are differences between individual cars of the same model. In addition, some cars may incorporate particular modifications. Driving style, road and traffic conditions, vehicle mileage and standard of maintenance may also affect fuel consumption; therefore the results do not express or imply any guarantee of the fuel consumption attainable.

Vauxhall Assistance and warranties*

- A one-year unlimited mileage manufacturer's warranty
- Second and third year no-fee customer option warranty up to 60,000 miles (from first registration)
- Vauxhall Assistance for 12 months from first registration
- Six years' body panel anti-perforation warranty

* = Warranty is only available on vehicles sourced from General Motors UK Limited. Terms and conditions apply - please see your Vauxhall retailer for details.

Optional transmission

Four-speed automatic transmission:

Available at extra cost on 1.8i 16v VVT models, Vauxhall's four-speed automatic transmission features an electronically controlled adaptive driving programme, which tailors its gear changes to match your driving conditions. It also features a winter mode, which selects a higher than normal gear, to reduce the possibility of wheelspin in icy conditions.

Steering

- Electro-hydraulic power-assisted steering
- Turning circle (kerb-to-kerb): 10.75m (35.3ft.)

Suspension

Front: Independent. Lightweight MacPherson struts with gas-pressure dampers and coil springs. Anti-roll bar. Hydro-formed subframe offers increased lateral stiffness. Hydraulic control arm bushing to give improved insulation from road noise.

Rear: Lightweight torsion beam rear axle with one-piece, hollow cast trailing arms. Built-in anti-roll bar. Progressive-rate double conical mini-block springs and gas-pressure dampers.

Brakes

- Anti-lock Braking System (ABS)
- Dual circuit, diagonally split braking system

1.6i 16v VVT

Front ventilated discs: 280mm diameter

Rear discs: 264mm diameter

1.8i 16v VVT

Front ventilated discs: 280mm diameter

Rear discs: 264mm diameter

1.9CDTi 16v

Front ventilated discs: 308mm diameter

Rear discs: 264mm diameter

Body

- Electro-hydraulic retractable hard top
- Aerodynamic drag co-efficient: Cd 0,31 (with roof raised)

Fuel tank capacity

All models - 52 litres (11.4 gallons).



47.1mpg

1.9CDTi 16v (150PS) engine is powerful yet economical

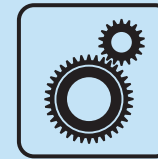

Transmission

Manual and automatic versions available

Exterior dimensions millimetres (inches)

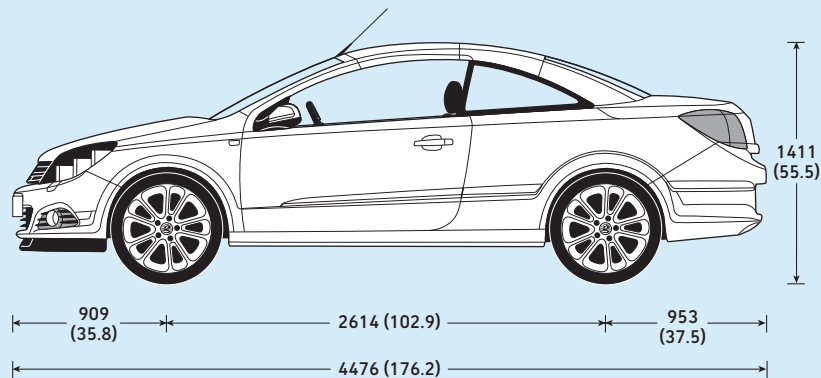
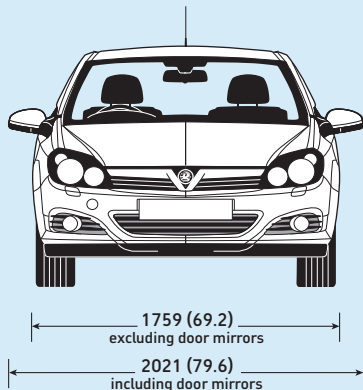

Luggage capacities (measured using the ECIE method)

	litres	cu.ft.
Roof up	440	15.5
Roof down	205	7.2



Easy Load boot access system

The Easy Load function assists the loading and unloading of the boot when the roof is lowered. Pressing the button, located on the load sill, raises the folded roof by 25cm and allows easy access to the boot.



When finished, simply press the button again and the roof panels are lowered back into position.

Weights and towing data kg

	Gross vehicle weight	Max. towing weights Trailer with brakes (without brakes)
1.6i 16v VVT Air/Sport	1865	1050 (745)
1.8i 16v VVT Sport/Design	1870	1200 (750)
1.8i 16v VVT Sport/Design automatic	1895	1200 (750)
1.9CDTi 16v (150PS) Sport/Design	1990	1200 (750)

Gross vehicle weight is the total permissible weight of the vehicle including passengers and their luggage. The **maximum towing weights** are based on the ability of the car, with two occupants of 75kg each, to restart on a 12% gradient, which is approximately 1 in 8.3, at sea level. At altitudes above 1500 metres, the engine output may drop with a corresponding reduction in towing capability. Any extra weight, such as luggage or additional passengers, should be deducted from the maximum towing weight. With a trailer fully loaded, **maximum noseweight** should not exceed 75kg. Always fit Vauxhall towing attachments and accessories available from your Vauxhall retailer. They are designed specifically for Vauxhall models and carry a 12-month guarantee.

Features explained

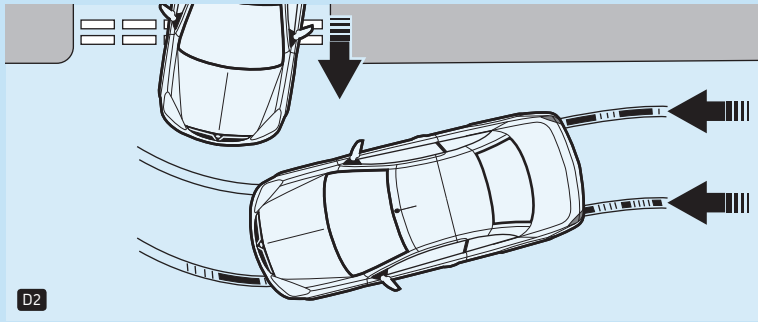

Anti-lock Braking System (ABS) with Cornering Brake Control (CBC)

D2. Cornering brake control makes the car easier to control in extreme situations, particularly when braking sharply on a bend. It is particularly effective when carrying out emergency procedures, such as avoiding a child's ball that's rolled out from the kerb. The system works by sensing the different rotational speeds of the individual road wheels and co-ordinating the level of braking pressure applied to each wheel. CBC is an integral part of TwinTop's comprehensive ABS.

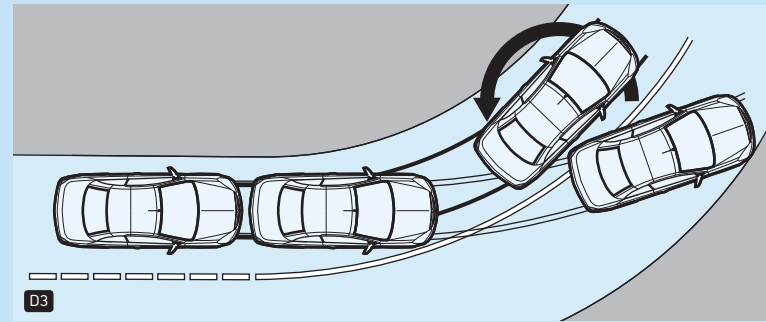

Electronic Stability Programme-plus (ESP-plus)

D3. ESP-plus provides enhanced yaw compensation during understeer or oversteer. It works by monitoring the front and rear of the car and comparing their respective directions of travel with the input through the steering wheel. If the vehicle starts to slide, ESP-plus applies corrective braking to the appropriate wheel, or wheels, compensating for the slide and helping you regain control more rapidly. ESP-plus offers additional safety in the form of two-way traction control, which helps prevent the driving wheels from spinning, under acceleration, on slippery surfaces.

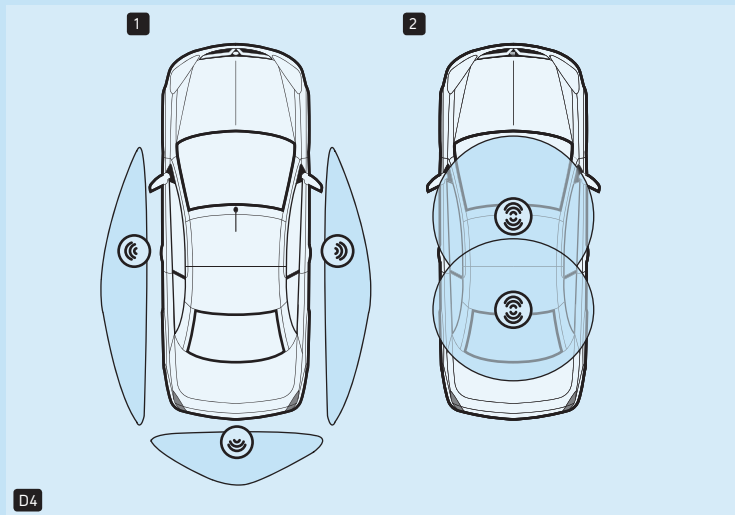

Keyless entry and start

D4. Fitted to Design models, the keyless entry and start system means that the driver need never remove their key fob from their pocket. When approaching the car, sensors in the front door handles and rear bumper **1** detect the driver's proximity and automatically unlock the doors or boot when the handle is pulled.

When in the car, two internal sensors **2** activate the ignition and release the electronic steering lock, enabling the driver to start or stop the engine by pressing the dashboard-mounted Start/Stop button. As an added safety feature, the engine will only start if the driver presses the foot brake while pushing the Start/Stop button.

Upon leaving the vehicle, the driver can lock it by either pressing a button on the key fob like a conventional system, or by simply touching one of the sensors on the external handles of the front doors. Either method will also close any open windows, a feature unique to TwinTop models.

Additionally the system offers excellent theft protection by its use of sophisticated cryptographic algorithms, while a back-up key is also included for emergency use.

Trust Vauxhall

Protecting the environment

Vauxhall's commitment to the environment is demonstrated by our products' many environmental awards, won both through the use of more recycled materials and by becoming cleaner and more efficient. For information on Vauxhall's efforts to achieve an environmentally sustainable future, see www.vauxhall.co.uk/recycling

Fleet Customer Services

Our dedicated support services for fleet managers includes factory demonstrators, a three-day test drive programme and information on whole life costs, company car taxation and finance. For further information please call **0870 010 0651**.

Buying your car

GMAC offers one of the most comprehensive and competitive ranges of financing plans in the UK. Contact your local Vauxhall retailer for details or call the GMAC customer service centre on **0845 712 3444**.

Vauxhall Extended Warranty

For complete peace of mind Vauxhall offers an extended warranty that can be purchased on an annual basis following the expiry of the original new car warranty. It covers most mechanical and electrical components. Terms and conditions apply, for further details please contact your local Vauxhall retailer.

Specialist Mobility advice

Motability accredited Vauxhall retailers can provide special mobility help and advice. Blue badge holders are entitled to very favourable discounts on new vehicles. Contact your local Motability accredited Vauxhall retailer or **Freefone 0800 731 5267**.

Servicing and maintenance

The best way to maximise the performance and reliability of your Vauxhall is to have all routine servicing and maintenance carried out at one of around 400 Vauxhall retailers. To find your nearest retailer call **0845 600 1500**.

In the event of an accident...

Vauxhall Accident Support helps keep you mobile following an accident. Benefits include scene-of-accident advice, message service, assistance with claims and vehicle recovery. For further details call **0800 010 304**.

Vauxhall Insurance

Available for new and used Vauxhalls, a Vauxhall Insurance policy offers a unique package designed specifically for Vauxhall drivers. For a highly competitive quotation, call **0844 84 85 840** (Great Britain) or **0845 35 13 410** (N. Ireland). Or just visit our website at www.vauxhall.co.uk

For more information...

For a brochure on any Vauxhall model (up to a maximum of three per caller) or location of your nearest Vauxhall retailer please **Lo-call 0845 600 1500**.

Alternatively, details can be found on our website at www.vauxhall.co.uk



- Save up to **£1500*** on a new Vauxhall with The GM Card
- **100 Rebate Points worth £100** when you use The GM Card for the first time
- Rebate Point saving is on top of any discount or offer negotiated with the Retailer
- Earn **3 Rebate Points (£3)** for every **£100** you spend

Typical 14.9% APR variable

To apply call **0845 746 2777** or visit www.gmcard.co.uk



When you have finished with this brochure please recycle it

The GM Card is issued by HFC Bank Limited and is available to persons aged 18 years or over and resident in the UK (or 21 and over in the Channel Islands) and is subject to status and conditions. Written quotations are available upon request from The GM Card, PO Box 3615, Birmingham B3 2RJ. The typical APR quoted is the rate for new customers. Rebate Points are earned on purchases using The GM Card. Rebate Points are not earned on Balance Transfers or Cash Advances. You earn money off a new Vauxhall/Saab by accumulating Rebate Points under the Rebate Points Programme. General Motors UK Limited is solely responsible for the operation of the Rebate Points Programme, which is subject to the Rebate Points Programme Rules. *You can redeem up to 2500 Rebate Points subject to the Model Line Maximum which will vary in amount in relation to different Vauxhall/Saab vehicle model lines and unlimited Partner Points. Rebate Points and unlimited Partner Points are redeemable as discounts on a new Vauxhall/Saab vehicle and must be redeemed four years from the issue date. Rebate Points may not be redeemed by Motability Contract Hire customers. The GM Card is a trading name and style of both HFC Bank Limited and General Motors UK Limited. HFC Bank registered in England. No. 1117305. Registered Office: North Street, Winkfield, Windsor Berkshire SL4 4TD is authorised and regulated by the Financial Services Authority. Member HSBC Group. HFC Bank Limited is not a member of the same group of companies as General Motors UK Limited, Saab GB Limited or GMAC UK plc. General Motors UK Limited. Registered Office: Griffin House, Osborne Road, Luton, Bedfordshire LU1 3YT. Registered in England number 135767. - CN6/0987.

Every effort has been made to ensure that the contents of this publication were accurate and up-to-date at the time of going to press (July 2009). Vauxhall vehicles are equipped with components manufactured by various General Motors operating units and outside suppliers. The Company reserves the right to alter specifications and withdraw products from sale without notice. Any such alterations will be notified to Vauxhall retailers at the earliest opportunity, please consult your local retailer for the latest information. The specifications detailed within this brochure are not necessarily applicable to alternative models such as Special Editions. Details of any such models will be contained in specific literature or found on the Vauxhall website. Please note that Vauxhall retailers are not the agents of General Motors UK Limited and are not authorised to bind the Company by any specific or implied undertaking or representation. It is advisable to ensure that your motor insurance policy provides adequate cover for additional fitted options and accessories. Please note accessories shown are for illustrative purposes only. As part of Vauxhall's policy of environmental care, this brochure is printed on paper manufactured using Elemental Chlorine Free pulps from specially farmed, sustainable timber resources. All rights reserved. No part of this publication may be reproduced in any form or by any means, without the prior written permission of General Motors UK Limited.

